

SKB

**TECHNICAL
REPORT**

86-28

**Pressure solution of minerals in
quartz-type buffer materials**

Mikael Erlström
Swedish Geological Company,

Lund, December 1986

PRESSURE SOLUTION OF MINERALS IN
QUARTZ-TYPE BUFFER MATERIALS

Miakel Erlström
Swedish Geological Co, Lund

December 1986

This report concerns a study which was conducted for SKB. The conclusions and viewpoints presented in the report are those of the author(s) and do not necessarily coincide with those of the client.

A list of other reports published in this series during 1986 is attached at the end of this report. Information on KBS technical reports from 1977-1978 (TR 121), 1979 (TR 79-28), 1980 (TR 80-26), 1981 (TR 81-17), 1982 (TR 82-28), 1983 (TR 83-77), 1984 (TR 85-01) and 1985 (TR 85-20) is available through SKB.

SWEDISH GEOLOGICAL CO
Mikael Erlström/JS

Date: 1986-12-31
ID-no: IRAP 86520

**PRESSURE SOLUTION OF MINERALS
IN QUARTZ-TYPE BUFFER MATERIALS**

Mikael Erlström
Swedish Geological Co

December 1986

Key words: Pressure solution, buffer materials, quartz sand, sand-
bentonite mixture

CONTENTS

	Page
SUMMARY	I
1 SCOPE OF STUDY	1
2 PRESENTATION OF THE PROBLEM	3
2.1 Diagenetic reactions	3
2.2 Occurrence of silica as cement	5
2.3 Chemistry of silica as cement	5
3 THE PROCESS OF PRESSURE SOLUTION	9
3.1 General	9
3.2 Solution mechanism	10
3.3 The effect of clay as matrix	13
4 EXPERIMENTAL STUDIES	17
4.1 Test arrangement	17
4.2 Preparation of samples	21
4.3 Microscopical investigations	22
5 RESULTS	26
5.1 Pure quartz sand	26
5.1.1 General	26
5.1.2 Analysis of thin slides	27
5.1.3 Summary	29
5.2 Sand-bentonite mixtures	29
5.2.1 General	29
5.2.2 Analysis of thin slides	32
5.2.3 Summary	35
6 CONCLUSIONS AND RECOMMENDATIONS	36
7 REFERENCES	38

SUMMARY

Two samples, pure quartz sand and a sand-bentonite (10 %) mixture, were tested under conditions of high pressure (200 bar) and temperature (115° C). The experiment was carried out over a period of 70 days. A series of thin slides were prepared on a resin embedded sample at the end of the test period. A microscopical study was performed as to obtain data concerning the effects of pressure and temperature. It showed that no pressure solution had taken place in the pure quartz sand. However, the individual grains had been severely fractured, thus causing significant internal sedimentation. The mixed sample showed that the clay component coated the quartz grains and significantly decreased the effect of stress in the grains by having a cushioning effect. Relative grain movement was facilitated by the clay, by which the grains rotated and slipped into stable positions with large contact areas and low contact stresses. This probably minimized pressure solution. However, a few contact regions indicated the presence of precipitated silica.

The investigation shows no definite evidence of pressure solution after an experiment duration of 70 days. Since the effect of solution may be time dependent at the applied temperature, it is recommended that further experiments be conducted at higher effective and porewater pressures but still at 115°C.

1 SCOPE OF STUDY

Buffer materials of sand/clay mixtures, either partially dry or entirely water saturated, will be affected by stress, heat and water percolation which vary recording to their mineral components.

One effect may be pressure solution at grain contacts leading to subsequent precipitation of cement reducing the porosity of the material. If cementation occurs it may become brittle and richly fractured on stress changes. Thereby, the hydraulic conductivity can be dramatically increased. Another negative effect of cementation processes is that the swelling ability disappears. Such processes may take place in the basal part of the sand/clay tunnel backfill of a KBS 3-type repository (Fig 1).

This study is focussed on the following issues:

- Under what conditions does pressure solution occur in natural sediments, similar to buffer materials?
- What bearing does this have on the buffer material in a repository environment?
- Is it possible to simulate pressure solution in buffer material in laboratory tests?

The report firstly summarizes and presents known facts concerning compaction and lithification of a buffer-like sediment in order to illustrate the complexity of the problem.

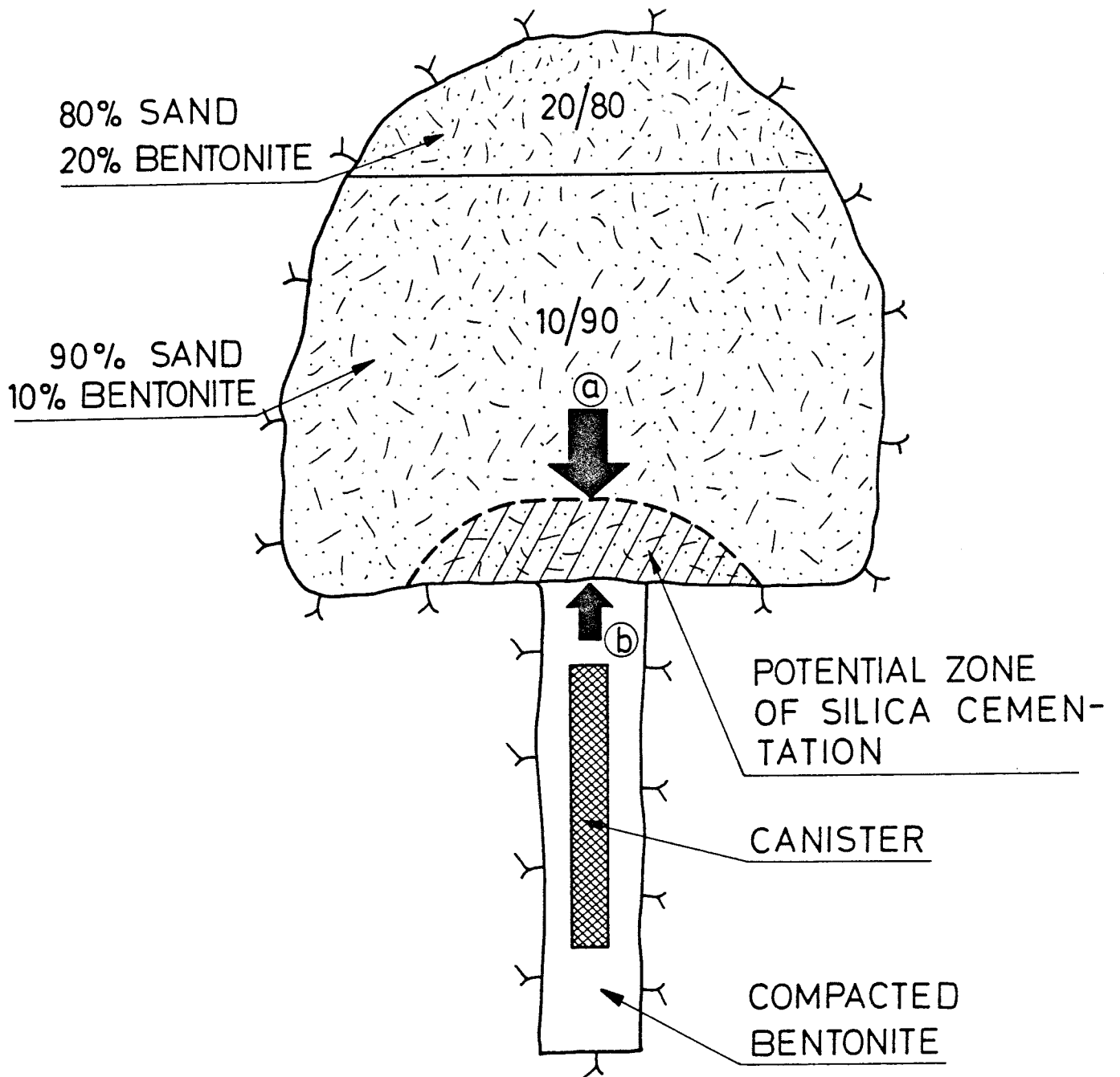

Fig 1. Schematic illustration of a tunnel with deposition hole. a and b visualize the main stress component acting on the zone of potential pressure solution

2 PRESENTATION OF THE PROBLEM

Compaction and lithification of a quartzose sediment after deposition is a common phenomenon which is of great importance in petroleum geology. The associated decrease in porosity and permeability due to precipitation of cementing agents, and thereby also a successively decreasing capacity to hold oil and gas, is of particular interest to this branch and has initiated a number of research disciplines which are directed to the study of sediment alteration due to stress and chemical attack.

Sediments are in general, affected by the following processes:

- grain re-orientation
- grain breakage
- plastic deformation
- pressure solution (including dissolution of grains and precipitation of silica as cement)

These processes, all of which tend to increase the density of the rock and eliminate open interstitial space between grains, are called diagenetic processes.

Increased temperature, pressure and chemical reactions between grains and pore fluids begin to influence a sediment as soon as it is deposited. Normally, diagenetic alteration near the earth's surface where the temperature and pressure are relatively low, no crystal alteration takes place. At increasing depth, with rising temperature and pressure, it passes into metamorphism, which includes an overall change of the sediment microstructure and crystal lattices, thereby altering the mineral composition.

2.1 Diagenetic reactions

Diagenetic reactions take place between individual, contacting grains in stationary or flowing groundwater.

They can be subdivided into the following stages implying reduction of the porosity (1).

- Mechanical compaction of the network of grains. This process includes rearrangement and deformation of the grains.
- Precipitation of cement in the pore space.
- Mineral reactions that produce clay minerals from feldspar and mica.
- Pressure solution resulting in increased compaction and precipitation of cementing material.

All these processes lead to a reduction of the pore volume. However, an increased pore volume (secondary porosity) can also result from diagenesis. This effect is caused by the following processes according to Björklykke (1).

- Dissolution of grains
- Dissolution of cement
- Mineral reactions resulting in loss of water, e.g. smectite - illite transformation
- Fracturing of clastic grains

The reactions occurring in a sediment are strongly depended on a complex group of variables prevailing in the depositional environment. The following compilation has been made by Maxwell (2).

Variables:

- Weight of overburden
- Fluid pressure within the sediment
- Temperature and temperature gradient
- Time
- Nature of sediment - composition, sorting and grain characteristics
- Composition of interstitial fluids
- Moving and static pore fluids

It can be concluded that all variables can be summarized into two groups of processes that lead to diagenetic alterations and modifications of a sediment i.e. Physico-chemical and physical processes.

2.2 Occurrence of silica as cement

Silica precipitated from super-saturated solutions can appear in many morphologic and crystalline forms such as:

- Microcrystalline subhedral crystals (Chert)
- Macrocrystalline mosaic of subequant blocks
- Microcrystalline elongate fibers (Chalcedony)
- Macrocrystalline euhedral secondary growths
- Macro- or microcrystalline replacement of carbonate minerals

The preference of one morphology type over another is not precisely known, but the following factors are known to be important as to supersaturation of the pore fluid, number or spatial distribution of crystallizing nuclei, and presence of foreign ions (cf. 2, 3, 4, 5).

2.3 Chemistry of silica as cement

Euhedral overgrowth of silica on quartz nuclei is a common feature in many friable sandstones. These overgrowths can be developed at temperatures as low as 20°C onto an existing crystal structure. The silica compounds grow directly on the quartz grain surface. Normally this process of an overall growth of euhedral quartz (Fig 2) is strongly dependent on the composition of the interstitial pore fluid.

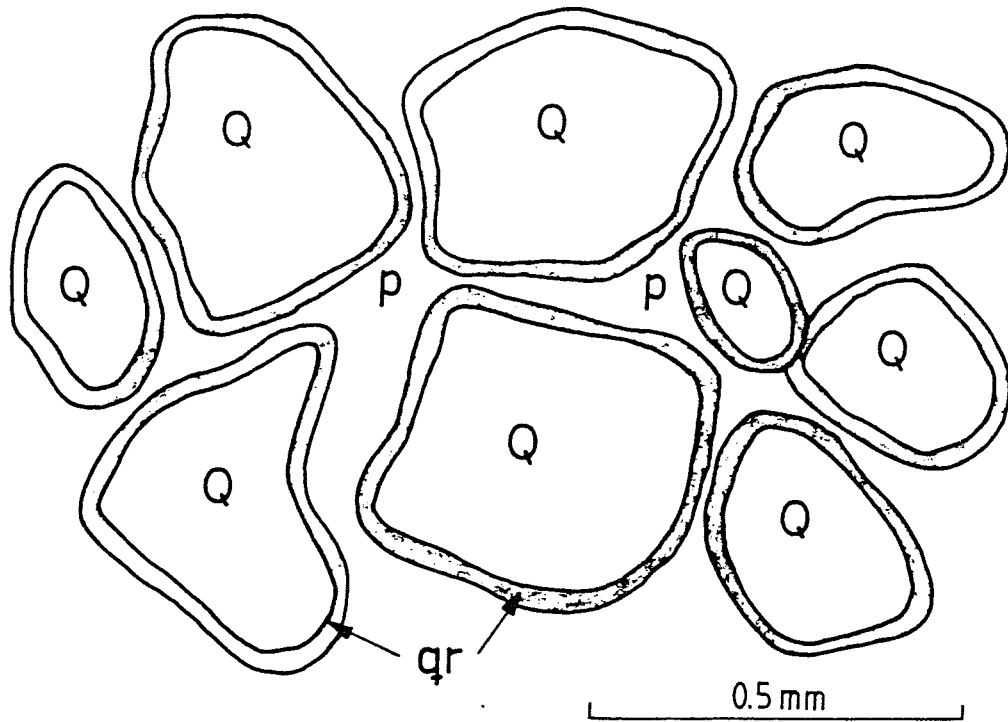

Fig 2. Euhedral growth of silica around quartz grains in loosely packed fabric. Q = quartz grain; qr = rim of quartz; p = pore space

Silica precipitation of this sort takes place under natural conditions when super-saturated fluids from underlying quartzose sediments in which dissolution processes take place, migrate into an environment with reduced silica solubility. The latter is represented by shallow sediments with low effective pressures and temperature. In this way many porous sands become lithified at relatively shallow depth of burial.

The solubility of amorphous silica changes linearly with increasing temperature and has a relatively higher solubility, at low temperatures, than that of pure quartz (Fig 3). Amorphous silica is therefore the dominant form of precipitated silica during early diagenetic phases.

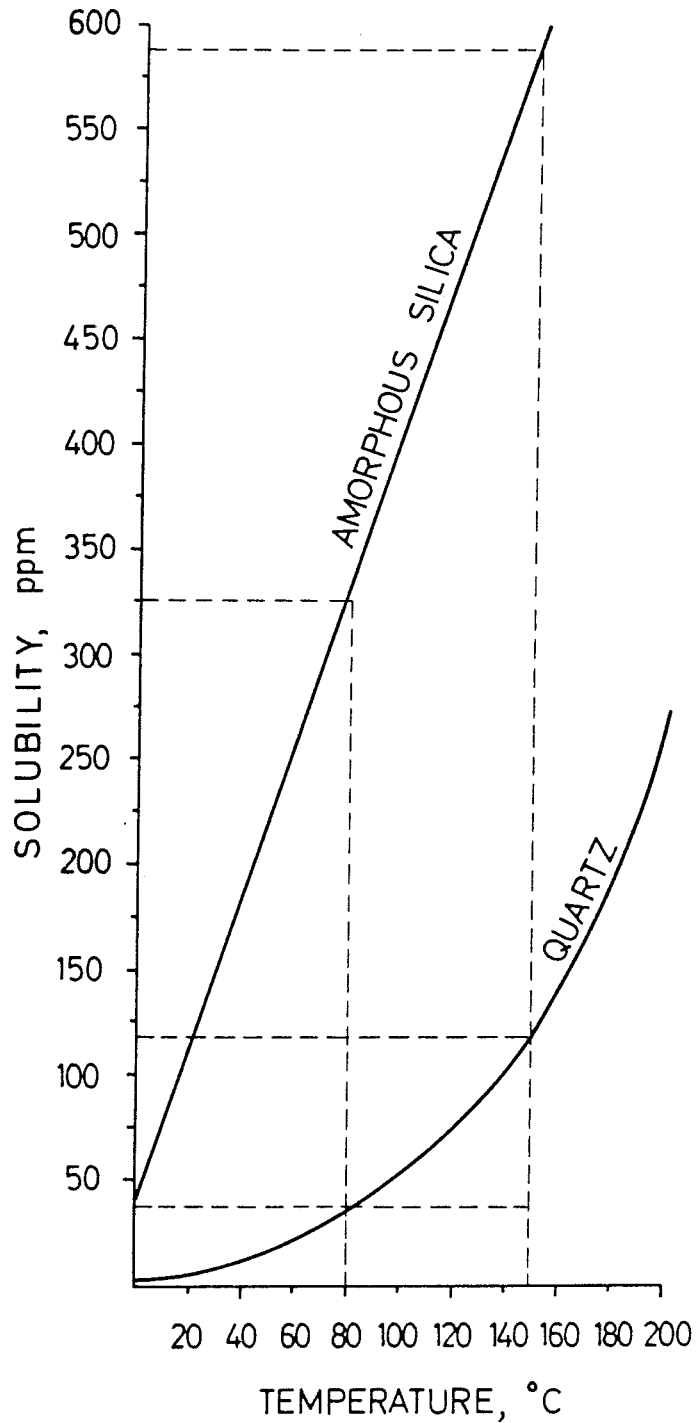

Fig 3. Solubility diagram of amorphous silica and quartz as a function of temperature. Dashed lines indicating temperature interval of potential interest in a repository environment

The solubility of silica does not only depend on the temperature but also on the grain pressure. It leads to dissolution of silica at the grain contacts and precipitation on the adjacent grain surfaces exposed to open pores, where the pressure is considerably lower and thereby also the solubility of silica (Fig 4).

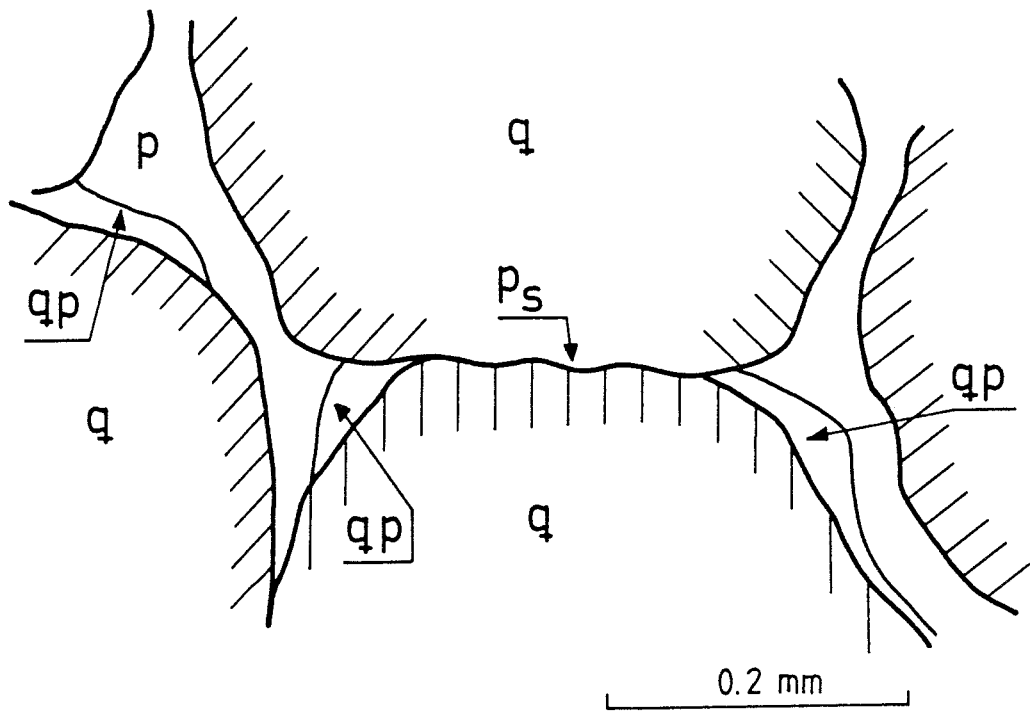

Fig 4. Principal morphological outline and occurrence of pressure solution and precipitation of silica in a quartzose sediment. q = quartz grain; qp = precipitated silica; ps = pressure solution; p = pore space

3 THE PROCESS OF PRESSURE SOLUTION

3.1 General

In highly quartzose sediments with high grain contact pressures a major part of the dissolved and precipitated silica originates from pressure solution.

The grain pressure causing pressure solution in a sediment is defined as Eq. (1):

$$S_e = (S_g - p_w) \cdot \frac{100}{k} \quad (1)$$

p_w stands for the pore pressure, S_g the geostatic pressure, and k the percentage of grain contact area (a^g) relative to the total horizontal cross section (A) of an assumed transverse section. The effective stress is determined by the burial depth, rock densities and pore pressure (Fig 5).

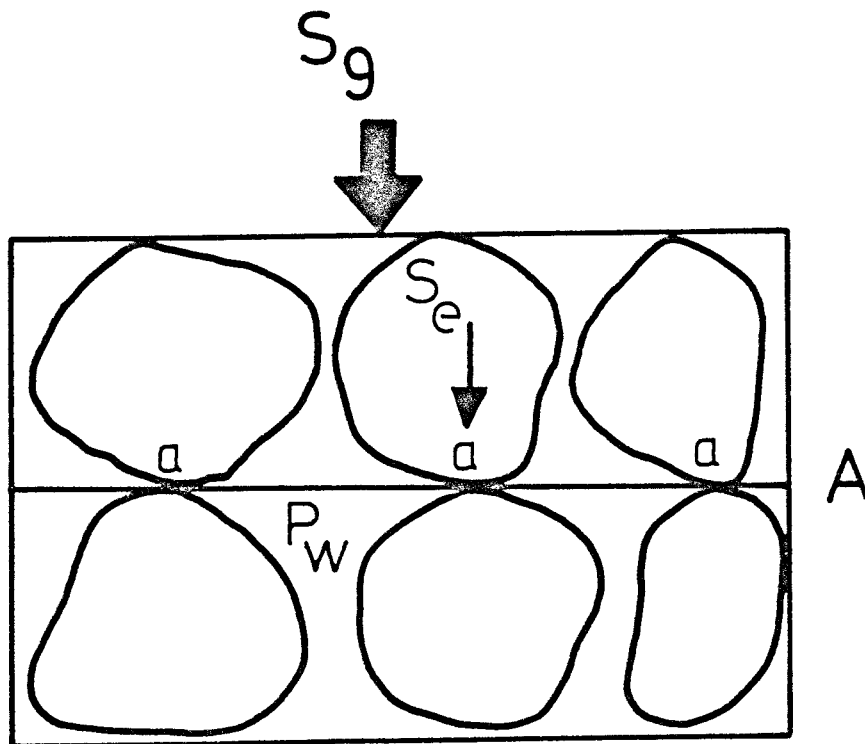

Fig 5. Parameters controlling pressure solution, a = grain contact, A = cross section, S_g = geostatic pressure, S_e = effective pressure, P_w = pore pressure

The critical grain pressure and temperature leading to rapid significant solution of silica at grain contacts is 250-300 bar and 270° C, according to Renton, Heald and Cecil, (3). The critical point at which pressure solution occurs has not been defined due to the great complexity of the kinetics involved in the process.

3.2 Solution mechanism

A major point is that there is an increasing tendency for deposition on the free faces of crystals contacting each others when the degree of supersaturation rises. At low contact pressures this degree is higher at the free faces than at the stressed ones, while at higher pressures the latter will grow and the free faces will not (6). The following general relationship has been suggested:

$$\frac{p^2}{E} \cdot V_{\text{solid}} = RT \log c/c_s \quad (2)$$

where p = pressure on stressed crystal faces

E = modulus of elasticity of the crystals

c = actual concentration of dissolved substance

c_s = maximum concentration of dissolved substance

R = gas constant

T = absolute temperature

For a crystal contact of the type shown in Fig 6, the solubility at surface A is (7):

$$\frac{m}{m_s} = e^{pV/RT} \quad (3)$$

where m = molality of solution

m_s = molality of saturated solution

V = molar volume

p = contact pressure

At surface B, the solubility is:

$$\frac{m}{m_s} = e^{p^2V/ERT} \quad (4)$$

where E = modulus of elasticity of the solid phase

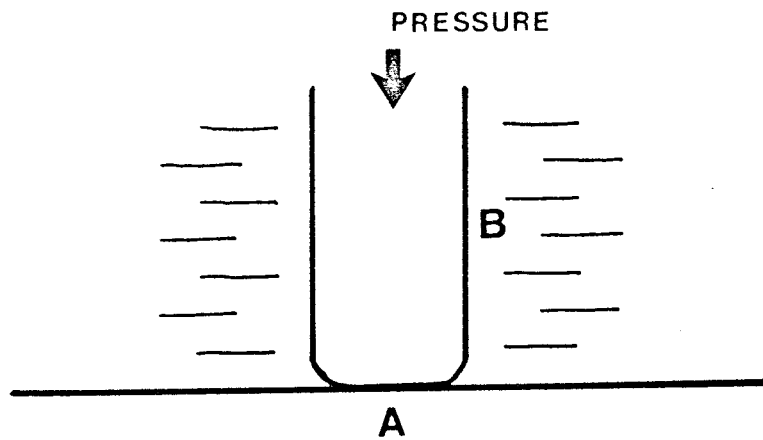

Fig 6. Grain contact definition of surfaces A and B

Putting $E = 10^5$ MPa and $V = 1.8 \cdot 10^{-4}$ m³ (H_4SiO_4) we find that the ratio of the solubility at surface A and B at 400 K increases by 1.7 times when the pressure is increased from 0.1 MPa to 10 MPa and by almost 3 times at 20 MPa. An increase from 0.1 MPa to 40 MPa would give a ratio of about 9. 0.1 MPa pressure would correspond to shallow sediments, while 20 MPa would correspond to the effective stress at slightly more than 1000 m depth. Since the pressure may well be in the range of 10-20 MPa in repositories of the KBS 3 type depending on the density of the compacted canister envelopes and the convergence of the rock, it is concluded that substantial dissolution and reprecipitation of silica may take place. Actually, a number of investigations of ancient sandstones suggest that pressure solution and "welding" of adjacent grains appear already at depths of 600-800 m, as illustrated by the diagram in Fig 7 (8).

This diagram fits well with the appearance of the Silurian sandstone in southern Gotland (Fig 8). This sandstone has been exposed to a maximum effective pressure of about 10 MPa due to ice overburden or - possibly - to Devonian sediments. Since the Silurian sandstone has not been heated to significantly higher temperatures than those prevailing at present, it serves as an excellent example of the effect of cementation that is produced by pressure solution.

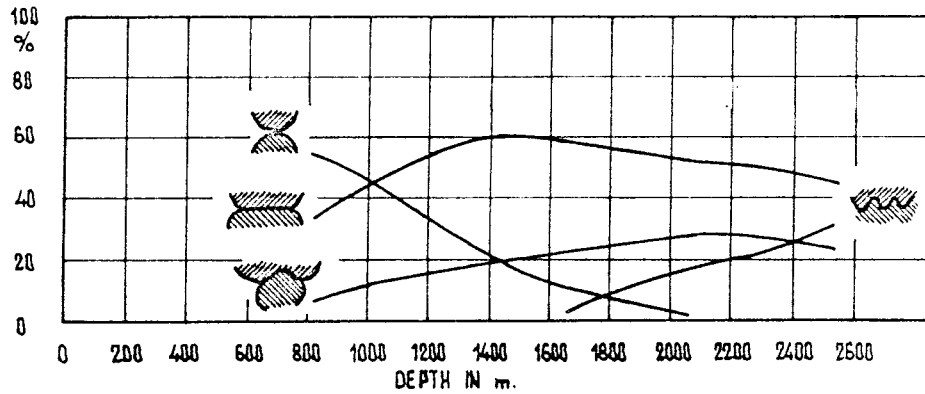

Fig 7. Frequency of contacts as evaluated from microstructural analyses (after Taylor). The small contact area arrangement (symbol at upper left) forms about 60 % at 700 m depth and disappears at about 2100 m depth, while the sutured contact (symbol to the right) appears at 1600 m depth and becomes predominant at about 3000 m depth.

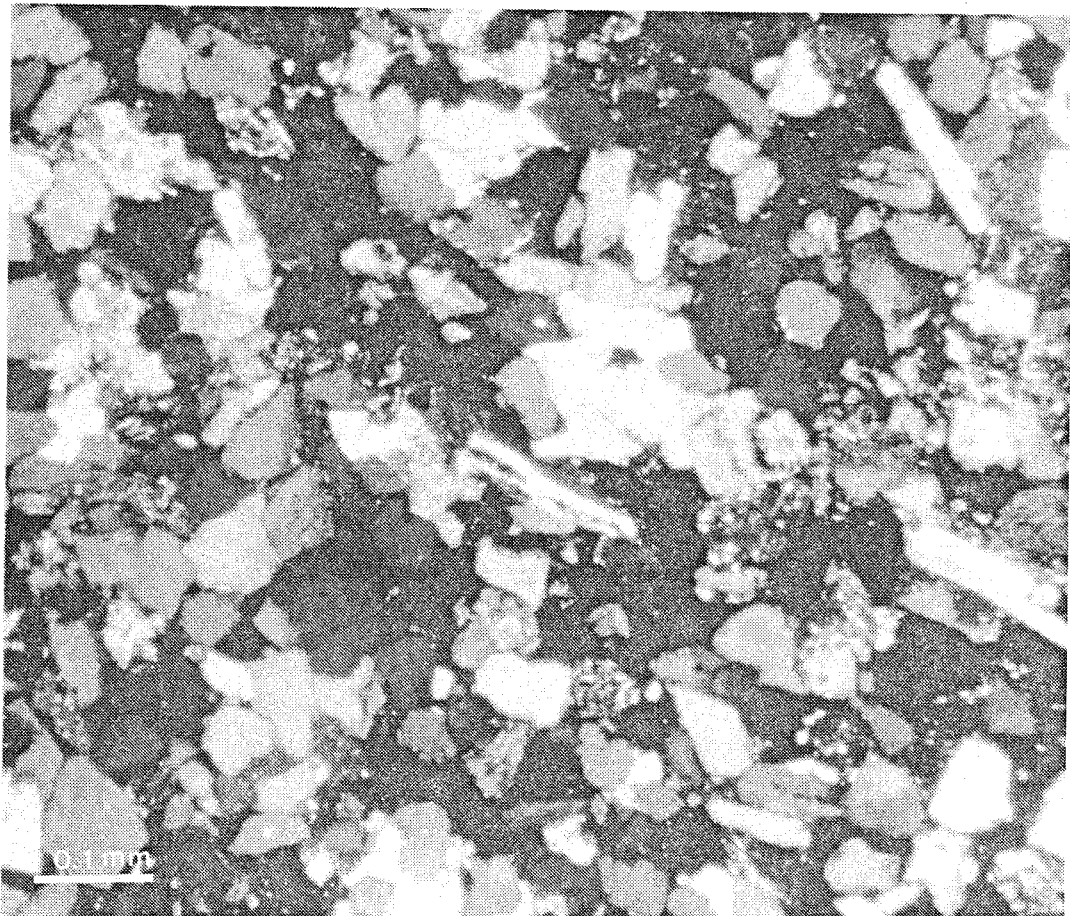

Fig 8. Thin section of Silurian sandstone from Gotland

3.3 The effect of clay as matrix

Results from several investigations (9, 10, 5) indicate that clay particles play a significant role in controlling pressure solution.

The amount of silica solution, produced by the presence of interstitial clay is strongly related to the type of clay mineral and the relative amounts of the constituents. Sufficiently high clay contents, implying that the quartz grains are separated by the clayey matrix has a decreasing effect on the process of pressure solution (Fig 6). Grain to grain contacts are few under such circumstances since the clay acts as a cushion between grains and distributes the contact stress between the grains. When 100 % of all voids in a well sorted medium grained (0.25-0.5 mm) sand are filled with clay materials, with the quartz grains still contacting each other, the amount of clay forms 35-45 % of the total bulk volume. The exact amount is strongly dependent on the type of packing, rounding and sorting of the sand-sized components that form the continuous grain network. Cubical packing, i.e. when the grains are stacked upon each other at right angles, exhibits the highest value of relative volume of voids. However, natural sands are composed of grains having a large range of size and configuration which leads to a corresponding spectrum of porosity at which the clay separates adjacent grains in a sediment. Heterogeneity in the packing is of great importance since it will control grain movement fashion during compaction and thereby also local variations in pressure solution susceptibility. Although it is quite reasonable to postulate that when the clay volume exceeds 25-35 %, which is the mean porosity values for natural non-compacted sands, it starts to decrease the effect of pressure solution.

If clay occupies only parts of the interstitial pore space as matrix the process of pressure solution has been found to be accelerated (5). It has been concluded that the physical and chemical character of the clay mineral particles enhances the solution of silica in pressurized quartz grains contacts (9) (Fig 10).

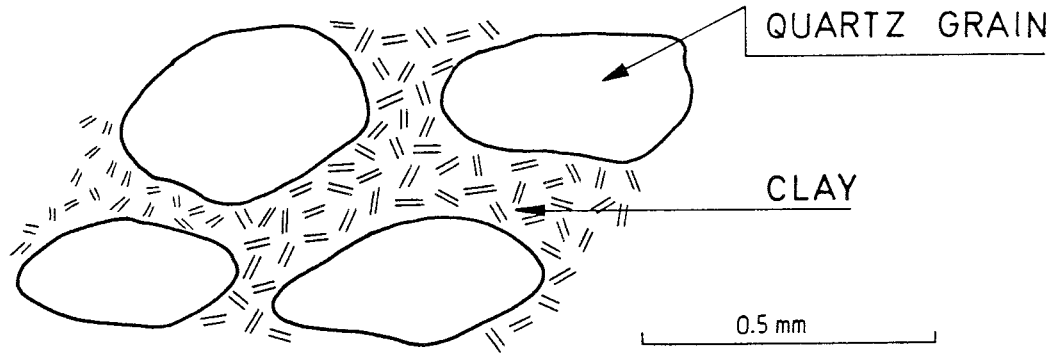

Fig 9. Clay material acting as buffering matrix in a quartzose sediment

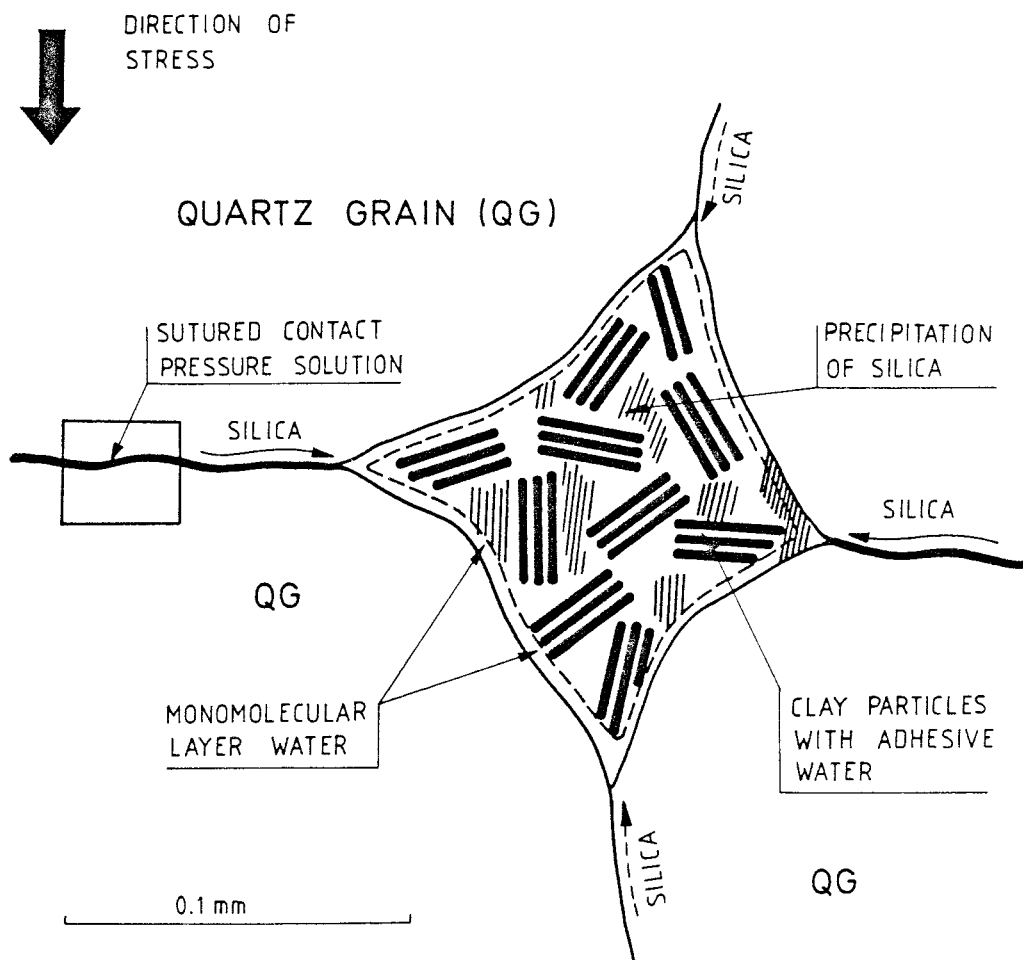

Fig 10. Schematic sketch of the effect of clay, in interstitial pore spaces, on the process of solution and precipitation of silica

Pressure solution appears to be strongly dependent on the solubility of silica in the porewater and on the monomolecular layer of water adsorbed on the grain surfaces. The amount of silica that can be dissolved in the form of orthosilicic acid H_4SiO_4 in this monomolecular layer is limited. Under stagnant conditions the amount of dissolved silica thus rapidly reaches a maximum level (Fig 11).

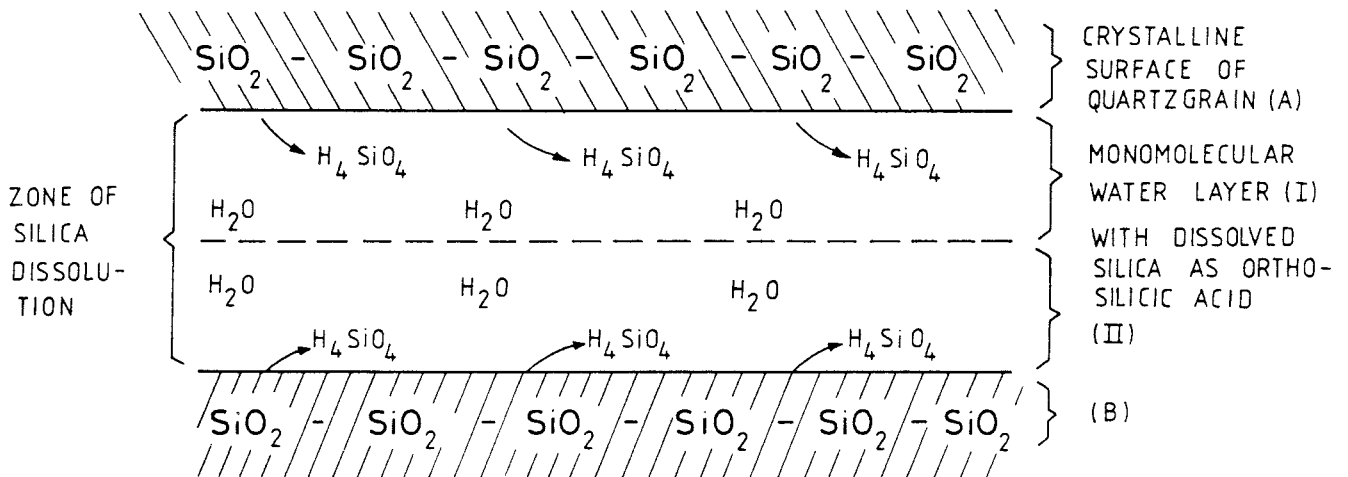

Fig 11. A schematic illustration of the process of silica solution, greatly enlarged (cf. Fig 10), at the interface of two quartz grains without any interstitial clay minerals

On water saturation the amount of dissolved silica increases (Fig 12). The clay minerals do also provide a migrating path for the dissolved silica and subsequent precipitation in nearby pores (cf. Fig 10).

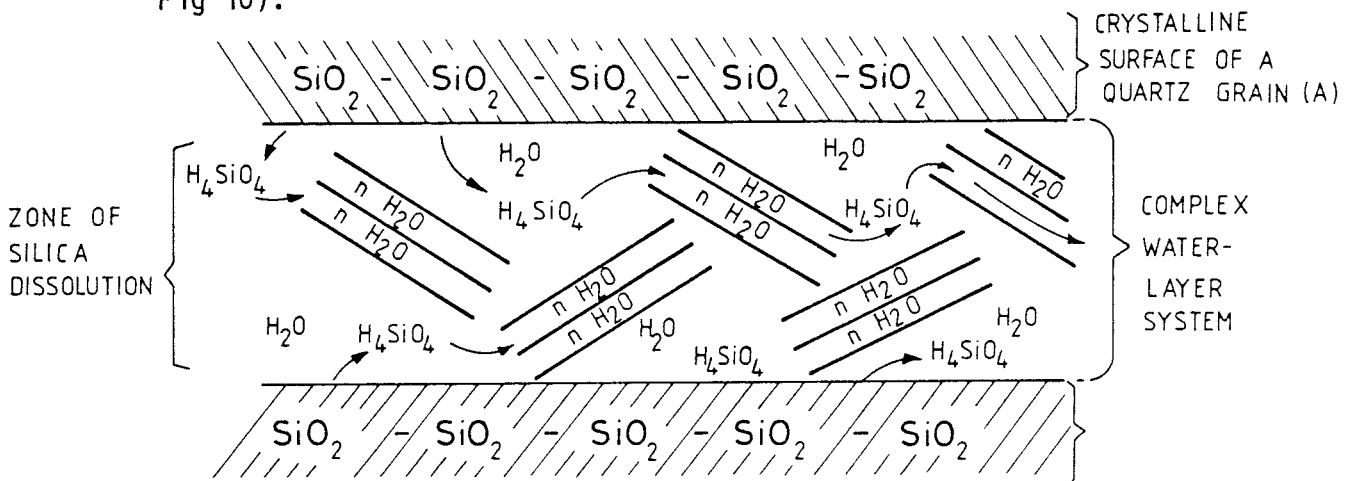

Fig 12. Process of pressure solution at grain interface (cf. Fig 10) with interstitial clay present

The type of clay mineral is also of great importance with respect to the effect on pressure solution. Strongly water sorbing clays, such as smectites, mixed layer minerals and hydromica are of particular importance since they provide the necessary characters. They often occur on the quartz grains in natural sands as pore linings and provide an excellent path of migration of dissolved silica in ortho-silicic acid form.

Kaolinite and chlorite are of minor importance as catalysts in the process of solution since they are weakly hydrated, carrying only a monomolecular layer of water.

The relative importance of different types of clay minerals in the presently discussed respect is best described in terms of the specific surface area (Table 1).

Table 1. Specific surface of the main types of clay

Mineral	Specific surface (m ² /g)
Montmorillonite	600-800
Mixed layer clays	(100-200)*
Hydromica (illites)	80-100
Kaolinite	10-20
Chlorite	5-50

* Uncertain value depending on degree and type of mixture

4 EXPERIMENTAL STUDIES

A pilot study was conducted on the following types of materials:

- 1) Pure quartz sand consisting of subangular grains
(\emptyset 0.25-0.5 mm)
- 2) Mixture of quartz sand (\emptyset 0.25-0.50 mm) as described above and
10 % granulate bentonite (MX-80)

4.1 Test arrangement

The materials were prepared and confined in oedometer cells equipped with a heat coil (d in Fig 13) and a temperature control (Fig 14). The temperature was measured by use of a thermal element attached to the steel ring enclosing the sample (I in Fig 13). The sample (b in Fig 13) was confined by porous bronze filters (a in Fig 13), through which the sample was saturated and kept under water pressure. The samples had a diameter of 50 mm and a height of about 35 mm.

The two cells (I & II) were emplaced in a box (i) filled with insulating material in order to maintain a constant and uniform temperature (Figs 15a,b 16).

The two pressure cells (Fig 15a,b) were fitted with copper tubings (f) to lead the pore water into the sample chamber through apertures (c) at the base and top of the pressured sample chamber. The tubings were furthermore fitted with coils (g) to let heat dissipate and not cause damage to the connecting plastic hose (j).

The upper end of the standpipe, which served as pore water supply, was left open during filling and saturation of the sample at room temperature and atmosphere fluid pressure. A consolidation (effective) pressure of 20 MPa was then applied after which pore water (distilled water) was filled in the standpipe to produce a porewater pressure of 0.2 MPa.

The pressurized, saturated samples were then gradually heated to 115 and maintained at this temperature for 70 days.

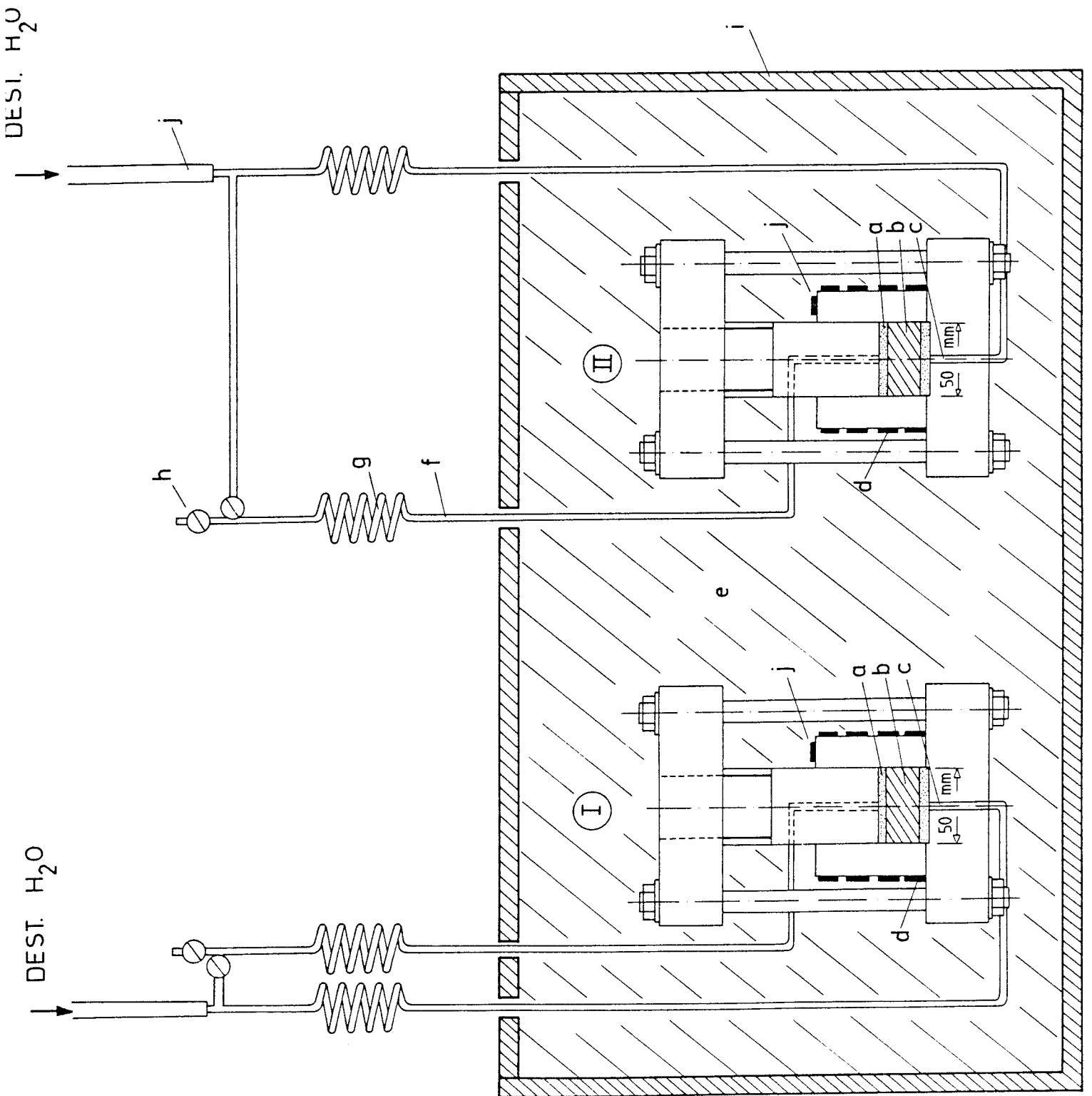

Fig 13. Scheme of design of the experimental equipment

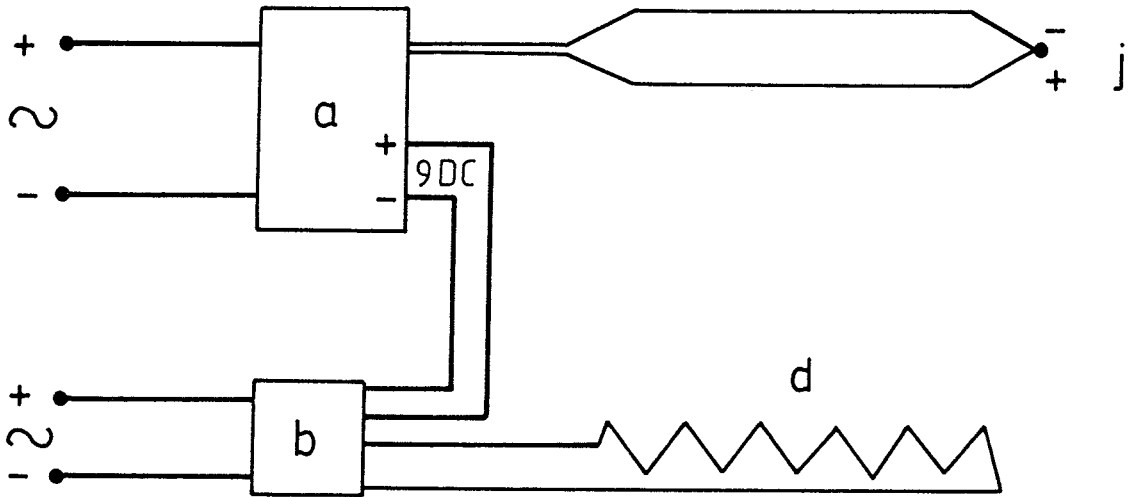

Fig 14. Circuit diagram of the temperature controlling system

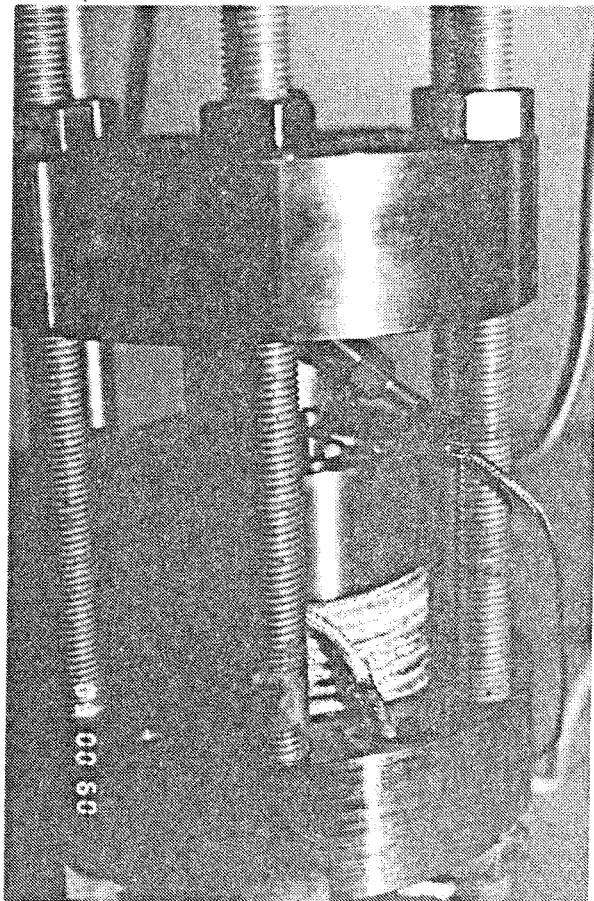
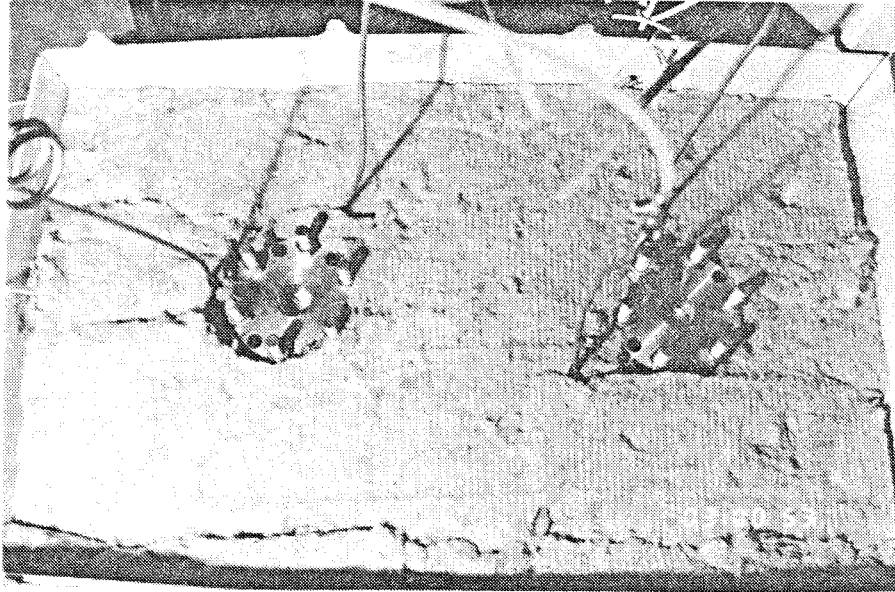

Fig 15a,b. The two cells placed in the box and embedded in insulating material. b: Close-up of oedometer cell with mounted heater, piping and temperature regulating system

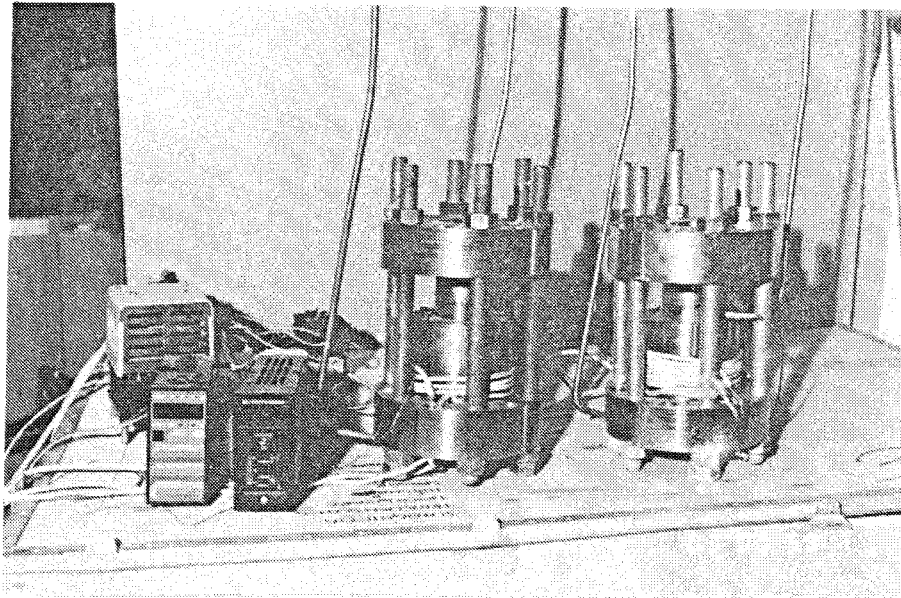

Fig 16. The two pressure cells with accessory equipment (heater, temperature regulating system, and copper tubing)

4.2 Preparation of samples

When the experiment was terminated the samples were carefully extruded and dried at 105°C. Through this the pore system was dried, which was the first step in the preparation for light microscopy. The sample was then connected to a vacuum-vessel. Araldite D resin was poured on top of the sample which is penetrated due to the applied vacuum. This made it possible to stabilize the larger part of the sample.

A series of 30 μm thin sections, obtained by conventional grinding, were oriented parallel to the major axis of the resin embedded sample (Fig 17). The following features were investigated in the microscopical study:

- Grain stacking patterns
- Packing heterogeneity
- Grain orientation
- Fracturing of grains
- Grain contact patterns
- Solution phenomena

- Cementation
- Crystal enlargement
- Aggregation - accretion
- Mechanical internal sedimentation

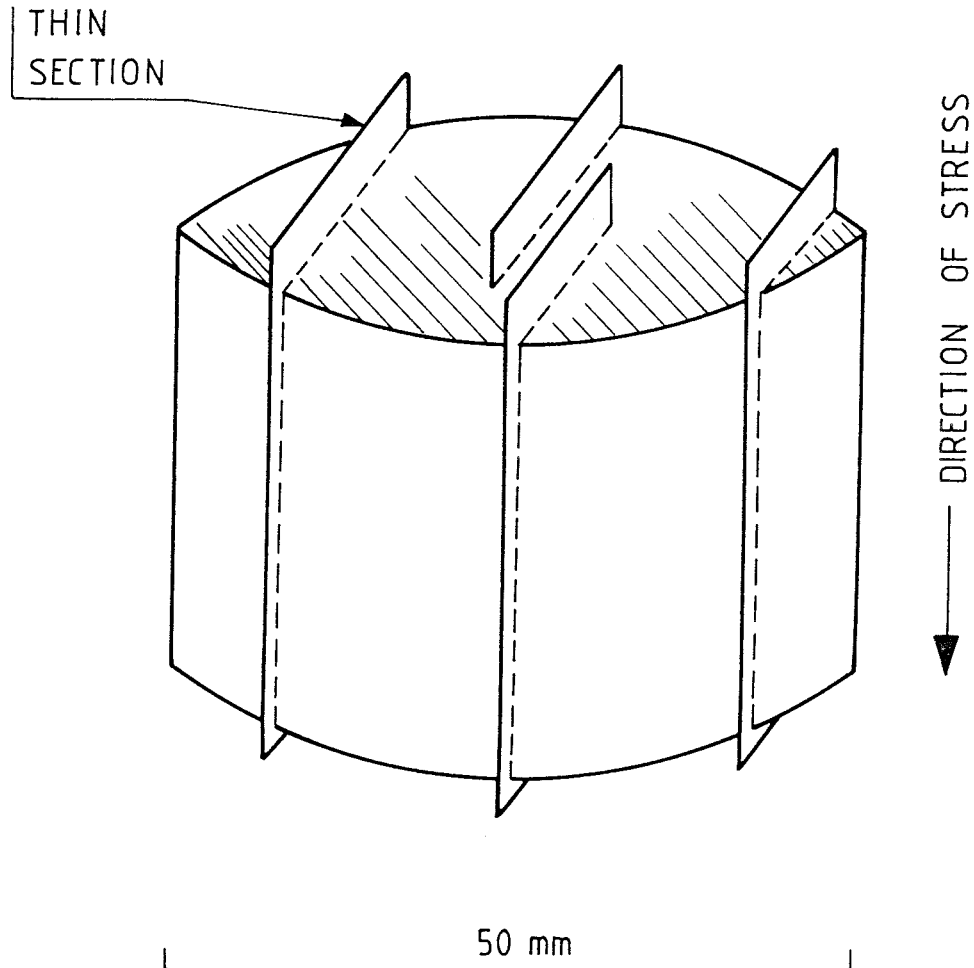

Fig 17. Orientation of the thin sections prepared from the resin embedded sample

4.3 Microscopical investigations

The thin slides were thoroughly investigated in a polarizing microscope (Leitz SM - Pol, 40-400x). A general texture survey was made initially for the selection of areas suitable for analyzing the sections with respect to stacking, packing, and orientation of grains in the samples. These detailed investigations revealed the major grain movement patterns that had taken place.

Clastic sediments react quite differently when exposed to compressive forces depending on grain size and shape, surface characteristics and deformability of the constituents. Fracturing and subsequent internal sedimentation of finer material in the pore space adds information about the packing of the material investigated.

The major issue was the character of the contacts between grains. These could be described as either floating, tangent, long, complete, or sutured which mirrors the influence of the effective pressure (Fig 18).

Each thin slide was then statistically analysed with respect to the grain packing using two standard concepts. This was made by using the mechanical stage of the microscope by which the thin slides could be moved systematically for inspection. Measurements were made by aid of the microscope ocular that was equipped with cross-hair and a micrometer for determination of the length of the traversed grains.

The first concept is termed the packing proximity (P_p) which was defined by Kahn (11) as defined by Eq. (5).

$$P_p = q/n \times 100 \quad (5)$$

q = number of grain to grain contacts and n equals the total number of contacts, which equals the number of grains.

The example in Fig 19 shows a plane intersecting a total of seven grains. Three grain to grain contacts, are seen from which we find the packing proximity to be:

$$P_p = 3/7 \times 100 = 42.9 \%$$

This parameter serves as a practical measure of the influence of pressure and compaction.

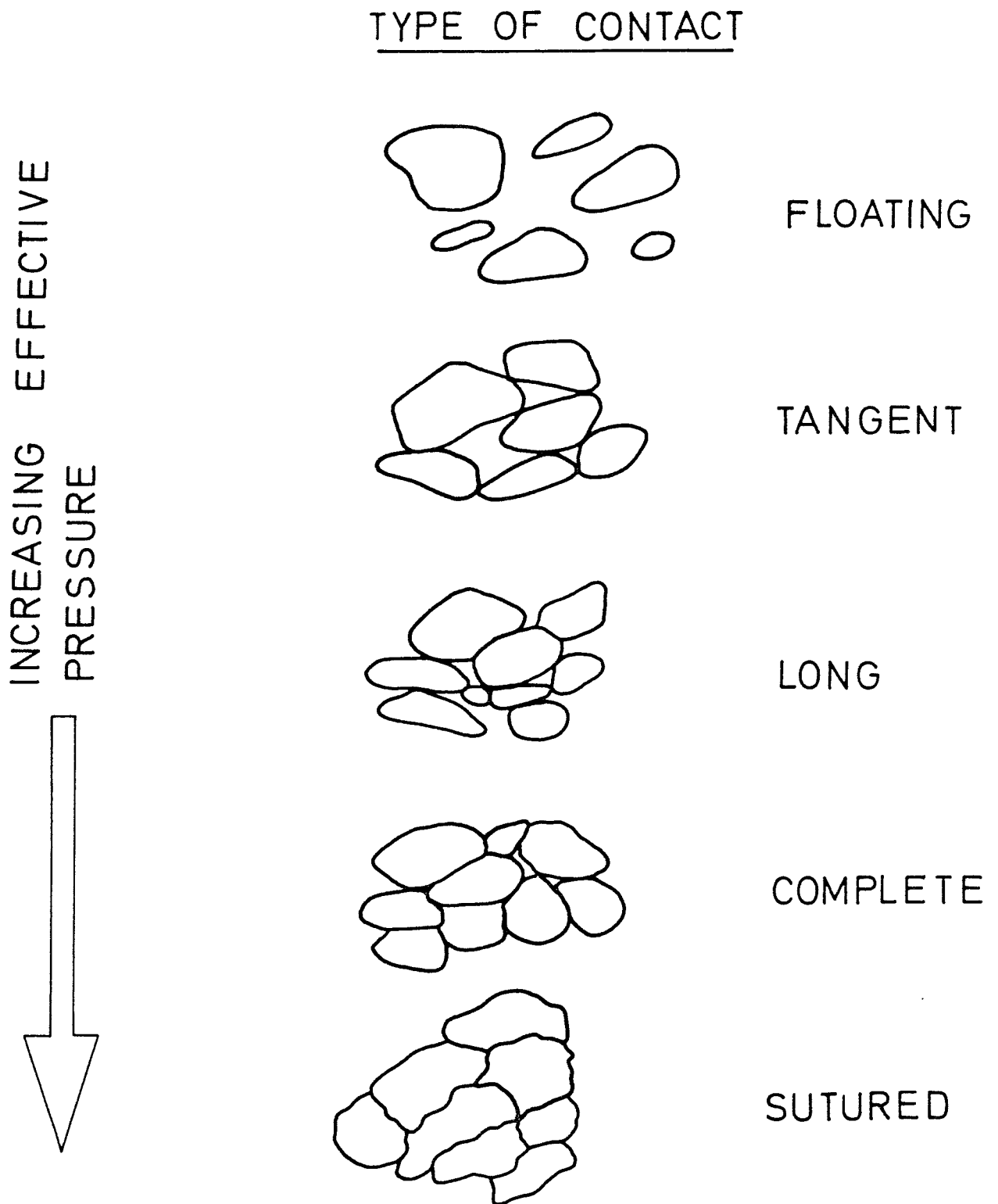

Fig 18. Illustration of different types of grain contact character as a result of increasing pressure

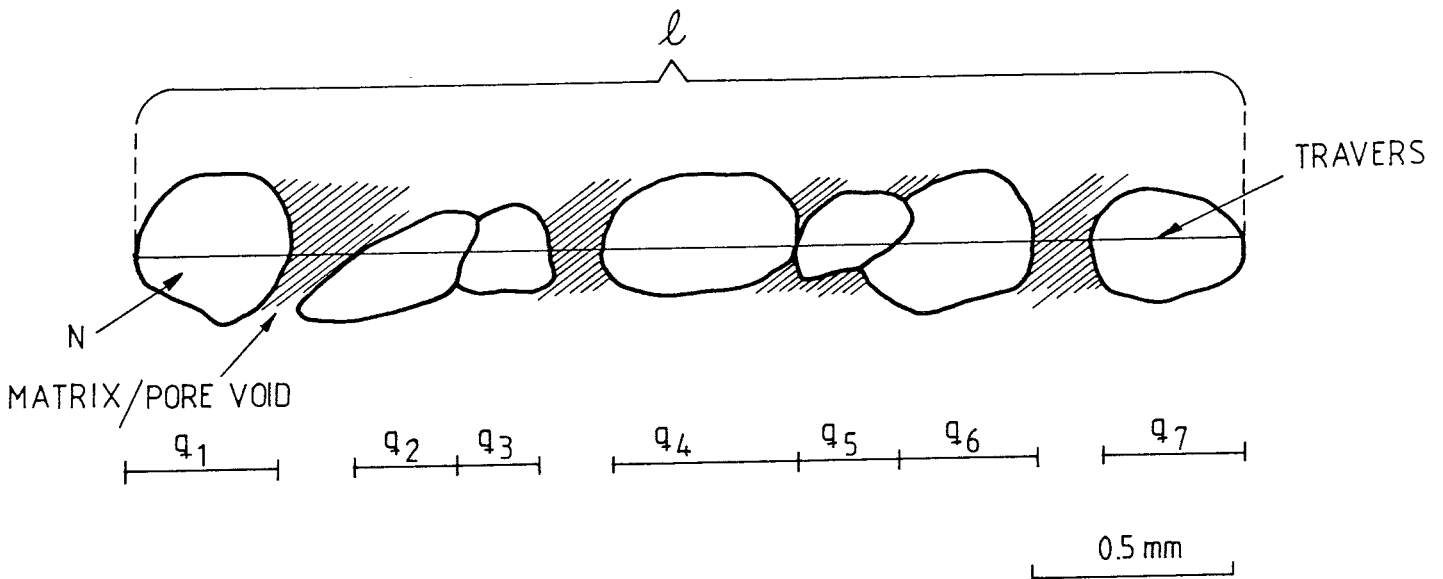

Fig 19. Schematic illustration of a statistical traverse

The second concept is the packing density (P_d) which was defined by Kahn as in Eq. (6):

$$P_d = (m \sum_{i=1}^n g_i / l) \times 100 \quad (6)$$

where m = correction term for various combinations of ocular, objective and scale, l = total length of traverse, g = grain contact length, n = total number of grains.

If we take m as unity and calculate the packing density for the example in Fig 19 we find the sum at the different grain to be $S_1 + S_2 + S_3 + S_4 + S_5 + S_6 + S_7 = \sum_{i=1}^{h=7} g_i$. This sum is then divided by the length of the traverse the result being an average measure of the packing.

A point counting investigation was also conducted on the thin sectioned material as to give an statistical measure of the sample composition. On an average 500 points were classified along traverses that were 0.50 mm apart and oriented parallel to the direction of compaction. The points were also separated by 0.5 mm in the individual traverses, and classified in the following groups; quartz grain (floating), quartz grain (contact), matrix (clay)/pore void.

5 RESULTS

5.1 Pure quartz sand

5.1.1 General

The sections showed that the sand sample consisted of angular as well as subrounded grains. The grains were usually fractured (Fig 20), which appears to result from the high effective pressure, i.e. 20 MPa. This fracturing produced fragments, which sedimentated as finer grained angular quartz grains (Fig 21). Most of the fragments accumulated in the basal part of the sample.

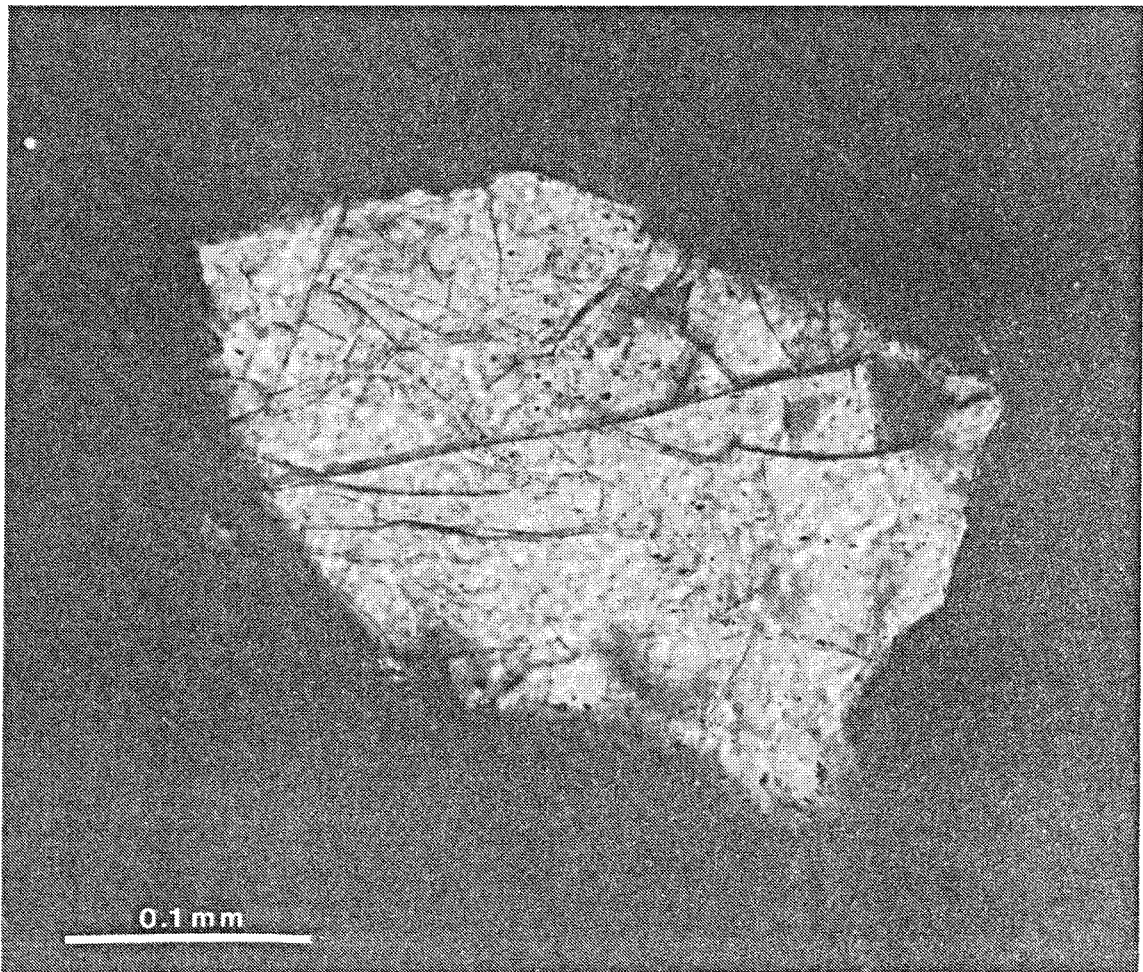

Fig 20. Fractured quartz grain caused by high grain contact pressure

The "internal" sedimentation and the compaction have led to a rather dense state of the sample with the fragments locking each other in a tightly fitting pattern.

The fracturing was caused by the almost instantaneous compaction in the compression machine which did not allow for relative grain movements that take place in the course of sedimentation in nature, where fracturing of this sort is uncommon.

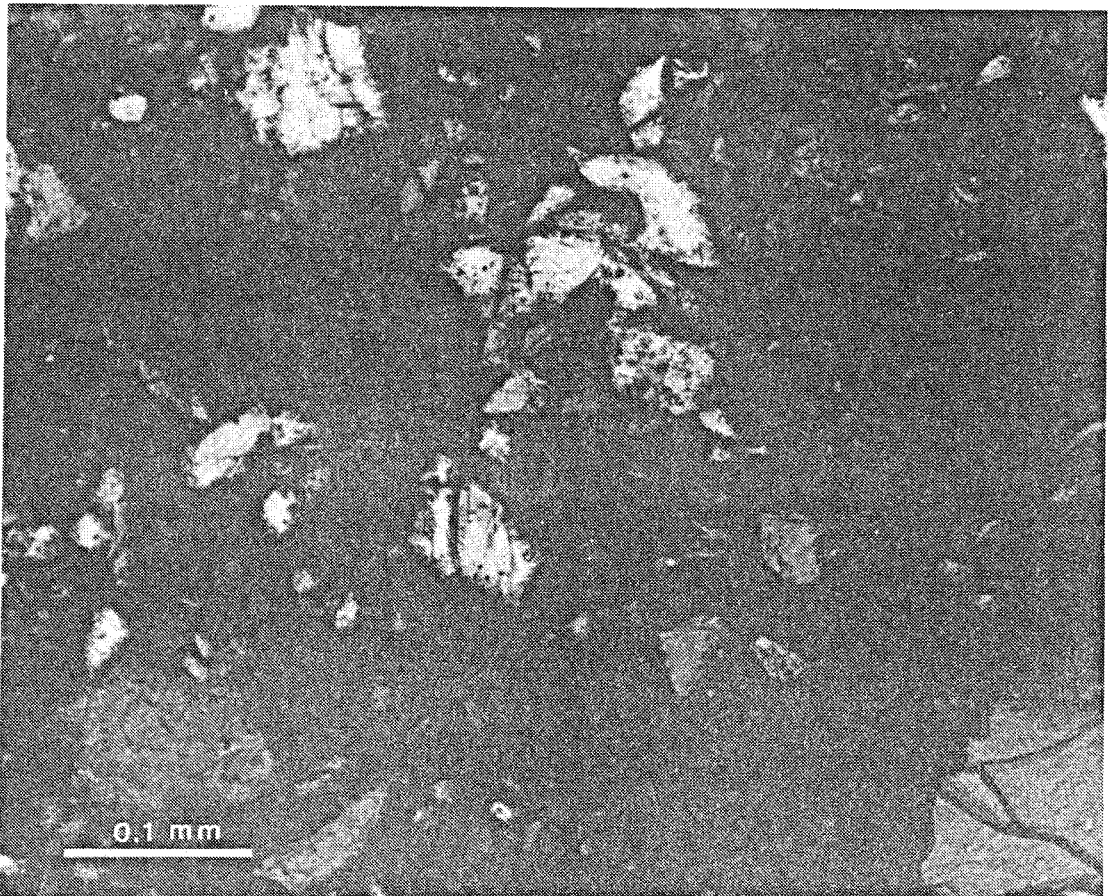

Fig 21. Fine-grained angular quartz grains originating from fracturing of larger grains and leading to internal sedimentation

5.1.2 Analysis of thin-slides

A general conclusion is that the microscopy did not indicate solution and precipitation of silica in any of the investigated thin-slides. The detailed study comprised application of a standard program for statistical investigation of packing proximity and density, and relative distribution of pores, grains with contacts, and "floating" grains.

This analysis included classification of 500 points on traverses running parallel to the direction of stress. The following results emerged from the point counting:

- Quartz grains, having one or more contacts with other grains	47.2 %
- Quartz grains with no contacts formed	16.4 %
- Pore space	36.4 %

	100 %

It is concluded that a significant amount of the grains have established contact with adjacent grains. The contacts were mostly "tangential" (Fig 22), which means that the edges or corners of the grains were contacting (cf. Fig 17).

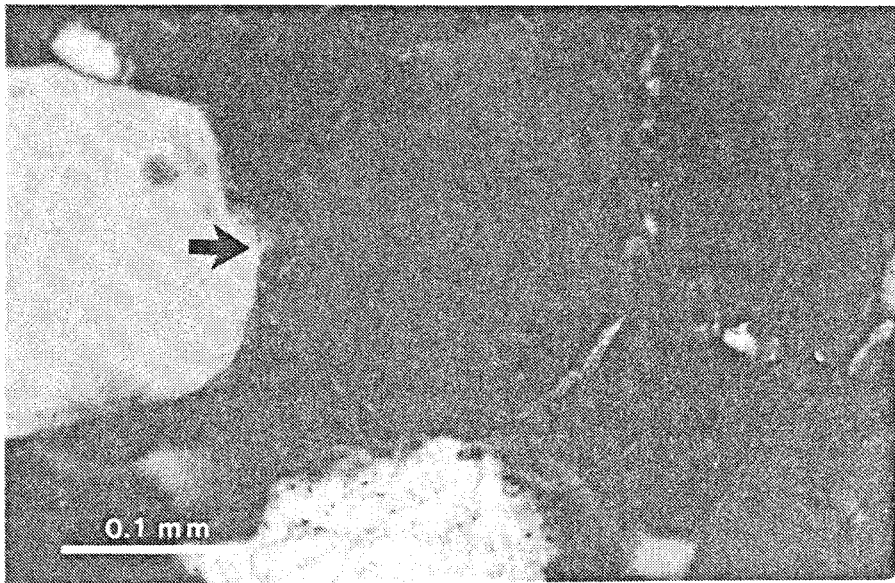

Fig 22. "Tangential" contact between grains in the pure quartz sand sample

"Long" contacts, i.e. arrangement in which there is common boundary of significant extension have only occasionally been observed in the quartz sand sample.

The floating grains seem to be intravoids resulting from the internal sedimentation. The grain fragments appear to have reduced the porosity and the amount of large voids in the sample.

The packing pattern is best described by determining the packing proximity and density. A traverse of 4 mm length was randomly chosen in the sample and oriented parallel to the axis of stress. The grains were counted and the number of contacts recorded according to the procedure described in Chapter 4.3 and Eq. (5). The traverse studied is schematically illustrated in Fig 23. A total of eleven grains ($q_1 - q_{11}$) were included in the traverse and four contacts between grains were analysed (A-D, Fig 23). This yielded a packing proximity (P_p) of 36.4 %. The packing density (P_d) is the sum of the transected lengths of each grain ($L_1 - L_{11}$) divided by the length of the total traverse (8), when taking the factor m in Eq. (6) as unity. P_d was found to be 76 % for the quartz sand sample.

5.1.3 Summary: quartz sand sample

No solution or precipitation phenomena have been observed in the analysed sample. Fracturing and internal sedimentation are, however, frequently occurring. Contacts between grains are dominantly "tangential" or occasionally "long". Fractures are also frequently "radiating" away from such contacts indicating a high grain contact pressure. Despite the compaction the porosity of the sample is high, i.e. 36.4 %. However, larger pores are not present because of the internal sedimentation.

5.2 Sand-bentonite mixtures

5.2.1 General

In contrast to the sand, the mixed sample was coherent when extracted from the oedometer. This was due to the continuous clay film which connected and embedded the larger grains. The earlier described statistical analysis of micrographs was applied also in this case.

At first, a general impression was that the clay appeared both as a coating of the quartz grains and as pore filling (Fig 24).

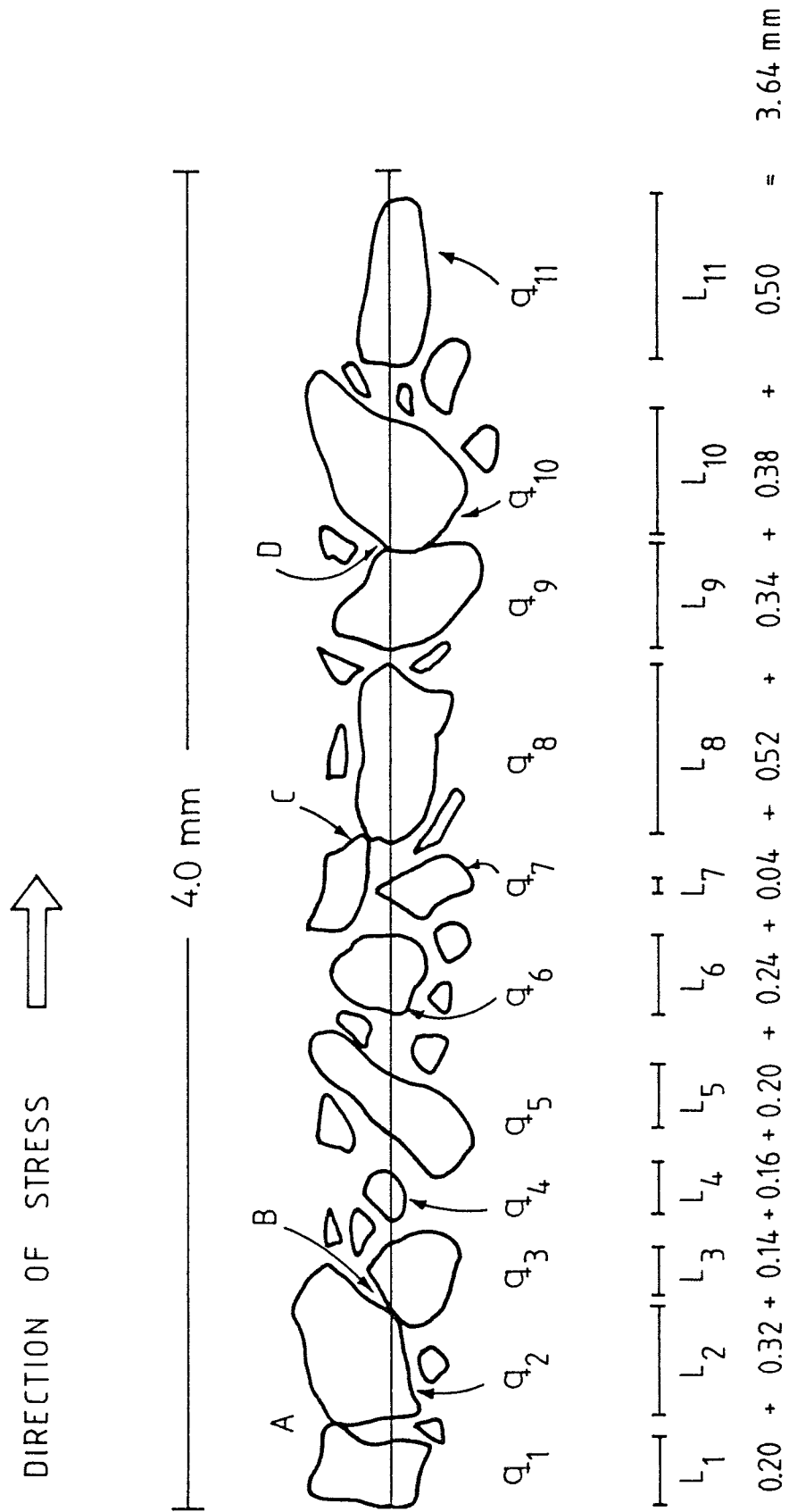

Fig 23. Schematic illustration of a section on which measurement of packing proximity and density values was based

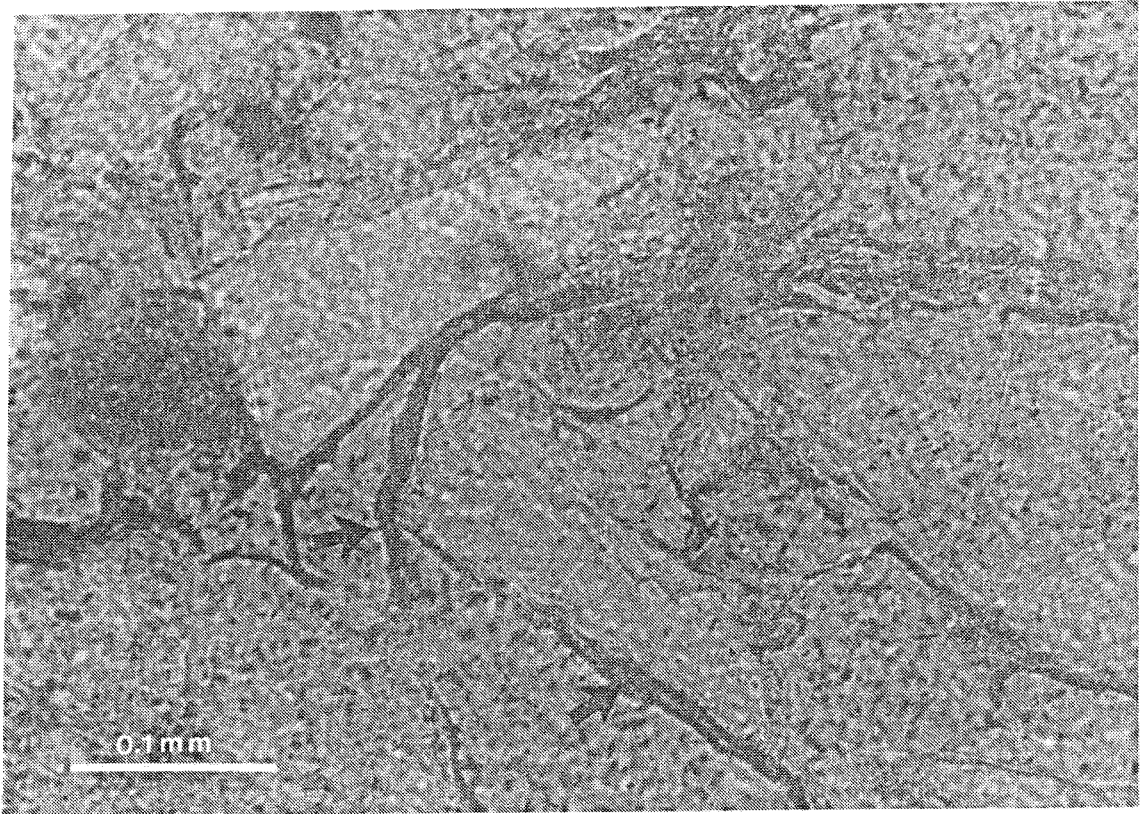

Fig 24. The occurrence of clay in the sand-bentonite mixture

The clay seems to have had a moderating effect on the degree of fracturing of the sample as documented by the low frequency of fractured grains. The internal sedimentation was logically found to be insignificant. Occasionally, clay was found to form buttresses and bridges between closely located grains (Fig 25) connecting separate quartz grains.

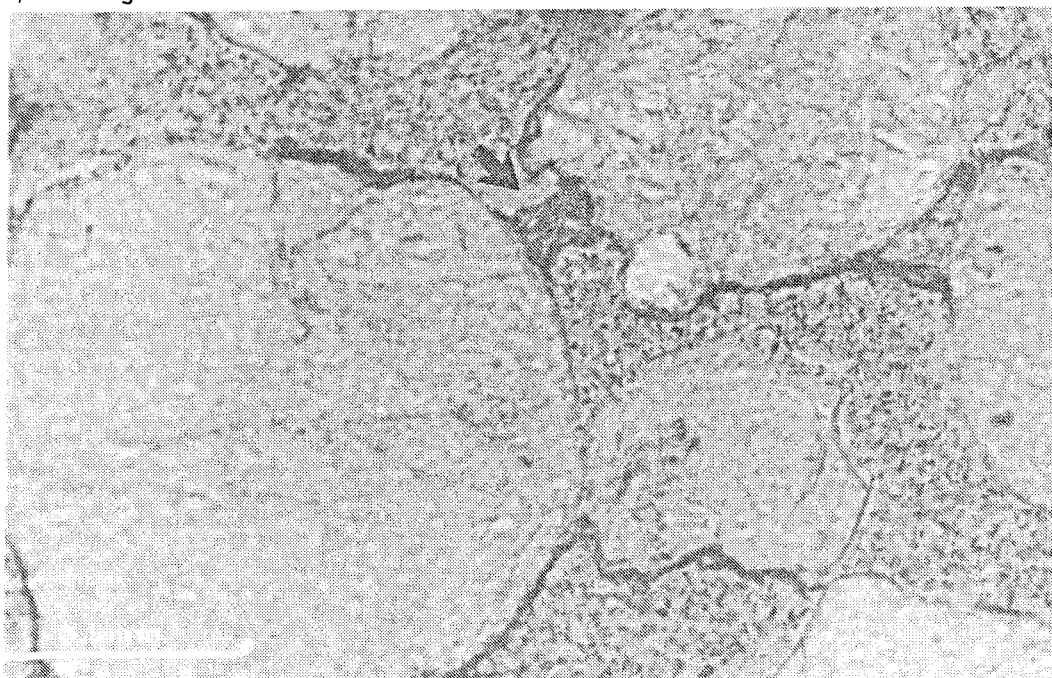

Fig 25. Clay occurring as bridges between quartz grains

5.2.2 Analysis of thin slides

The textural framework of the mixed sample was found to be somewhat different from the quartz sand sample. Thus, the pores were generally free from angular quartz fragments originating from fractured grains and instead partially lined or filled with clay (Fig 24). The clay was also somewhat denser at the grain contact.

The point counting analysis yielded the following results:

- Quartz grains having one or more contacts with other grains	35.0 %
- Quartz grains, floating and establishing no contact with other grains	14 %
- Clay (matrix)	19.6 %
- Pore space	31.4 %

	100 %

The frequency of grains that were in contact with each other is somewhat lower than that of the quartz sample and this appears to be related to the presence of clay. It is interesting to see that the clay did not fill the voids completely. This may partly be explained by the coatings of the samples before resin treatment, but it is also concluded that incomplete filling is actually a common phenomenon in mixing components of the investigated sort with a low smectity content.

The grain to grain contacts are either tangential or long with no evidence of solution or precipitation. Occasional contacts have some resemblance to precipitated silica caused by pressure solution. Fig 26 shows a microphotograph of two large quartz grains with a "long" contact interface. At the upper part of the contact a concentration of silica is found which does not fit the optical properties of the two interfacing quartz grains. Cracks are also emerging from the same point and these could possibly act as pathways for additional, dissolved ortho-silicic acid to precipitation centra.

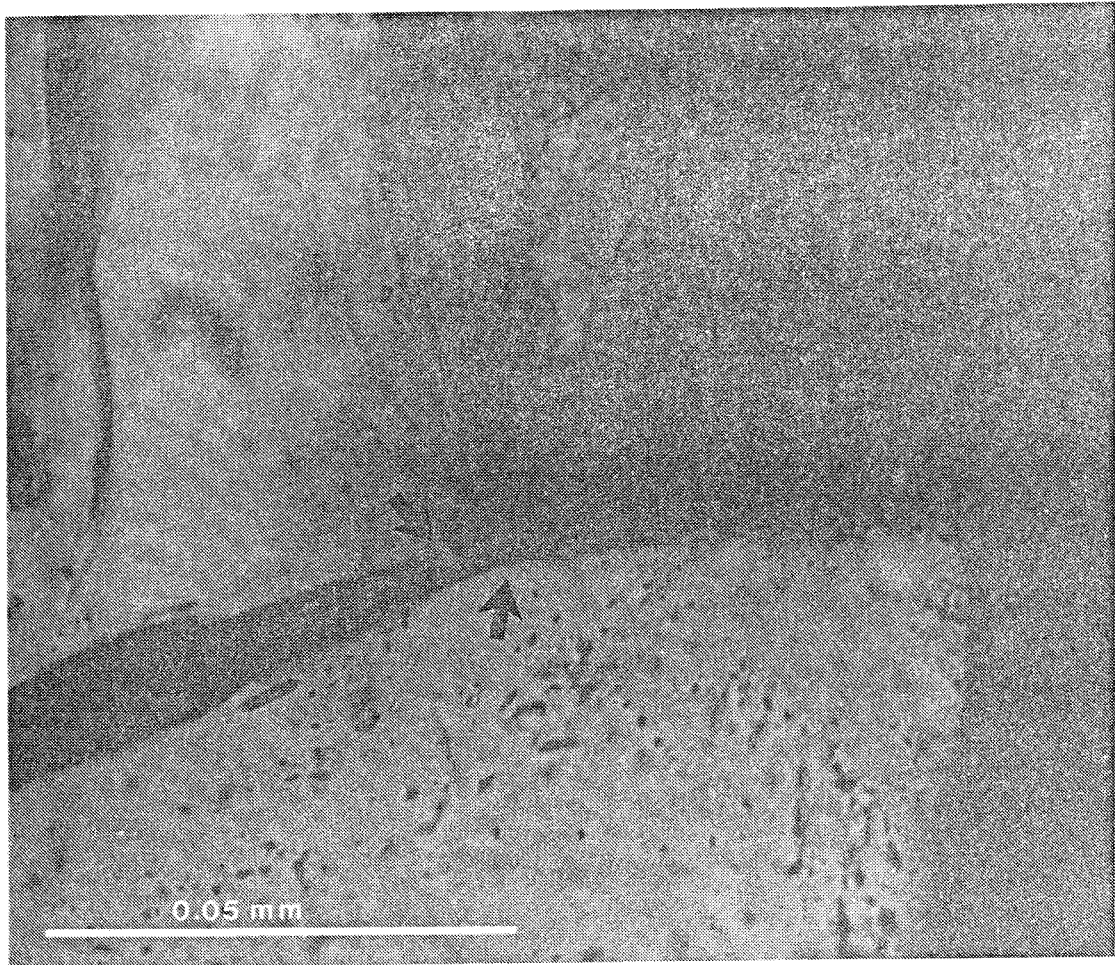

Fig 26. Assumed precipitated silica at a grain contact

Statistical analysis of micrographs using the packing proximity concept was applied to a randomly chosen section that is schematically illustrated in Fig 26. Twelve grains were included in the 4 mm long section, four of which had established grain to grain contacts. This yields a packing proximity value of 33 % which is somewhat lower than for the pure quartz sand. Also the packing density was determined and it was found to be 78 %, i.e. not significantly different from the value 76 % we obtained for the quartz sand sample (Fig 27).

The somewhat lower packing proximity than for the sand sample probably caused by the stress distributing property of the clay when it is located between grains. This can be seen in the investigated traverse where several grain/clay/grain contacts appear.

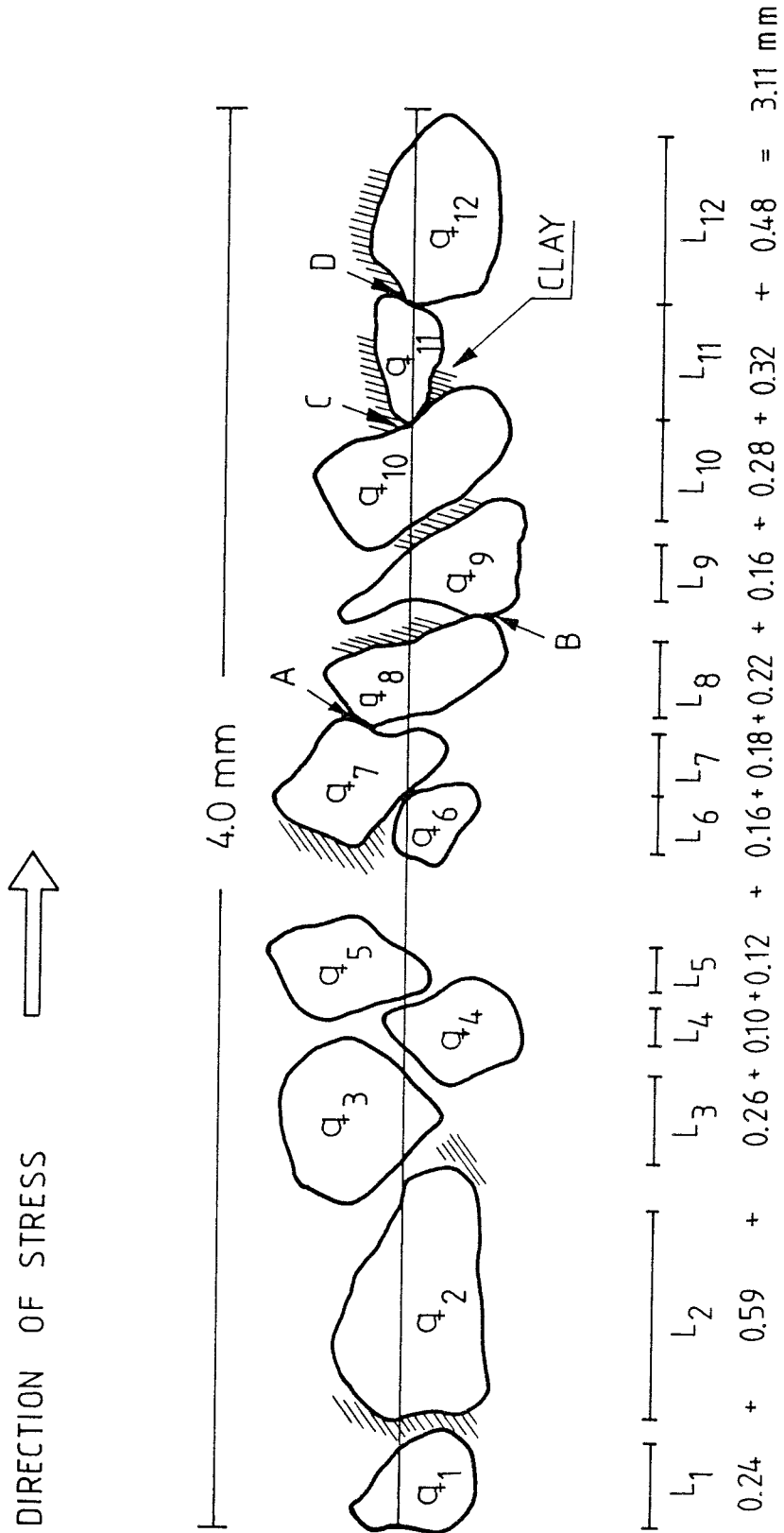

Fig 27. Schematic illustration of section for which relative packing proximity and density was measured

5.2.3 Summary: Quartz sand-bentonite mixture

The sample exhibits somewhat different microstructural features than those of the pure quartz sand. Thus, the pore voids, which are lined or partially filled with clay are larger in the clayey sample. Internal sedimentation is insignificant. Grain to grain contacts are of the edge-to-edge type or of long extension. Grain clay grain contacts are the most common ones. Pressure solution has not been identified in the sample while there are indication of local precipitation of silica.

6 CONCLUSIONS AND RECOMMENDATIONS

The two samples investigated do not show any significant degree of cementation due to pressure solution and precipitation of silica. Only a few silica-like precipitations have been identified at grain to grain contacts and they were found in the sand-bentonite sample.

There is no definite answer to the question whether the temperature 115°C that prevailed during the experiment was sufficient to generate solution, migration and precipitation of silica. Similar experiments, although carried out at higher temperatures, show that solution of silica does occur at temperatures than 270°C at moderate pressure (3), and this effect may be expected at lower temperatures though at a slower rate. Boer et al (5) arrive in their investigation to a critical temperature of 330°C where there is a reasonable chance to produce overgrowth of quartz within an experiment duration of a year. Maxwell (2) gave examples of significant cementation at temperatures above 270°C. Compaction below this temperature appeared to be due to mechanical reorientation and breakage of the quartz grains according to this author.

The experiments demonstrate that temperature is probably the most important single factor leading to solution of silica. Pressure seems to be of minor importance although the Silurian sandstone that was mentioned earlier in the text definitely shows that pressure alone may well produce solution effects given sufficient time. The breakage of grains in the quartz sand test is assumed to promote increase in grain surface accessible to solution. Fractures can act as pathways of orthosilicic acid into precipitation centra.

Breakage of grains in the two investigated samples was mainly caused by the fast increase in load. Thus, the grains did not have time to adjust themselves in a natural way and were therefore fractured radially from the point of grain to grain impact. Completely fractured grains were not so frequent in the mixed sample indicating a load distributing effect of the clay between grains (10) although only 10 percent of MX-80 clay was added to yield this.

The experiment was carried out over a period of 70 days and no cementation in the investigated samples could be found. The involved kinetics is perhaps the most uncertain variable in these and other cases in which the degree of confinement is not well defined and it is therefore difficult to state whether a prolonged experimental period would have induced significant cementation. However, it seems as if the temperature needs to be higher than 115°C in order to produce significant silica solution and precipitation even in a long time perspective. Still, the matter should be investigated at this temperature in long-term experiments. It is therefore recommended that a series of tests of long duration be carried out for determination of a threshold value of the temperature.

A general conclusion is that while clay between quartz grains distributes and thereby reduces the contact stress, it may enhance pressure solution by acting as a catalyst.

The following observations have emerged from the investigation:

Quartz sand	Sand-bentonite mixture
-----	-----
* Significant grain breakage	* Minor grain breakage
* Internal sedimentation of fragments	* Insignificant internal sedimentation
* Edge-wise and occasionally long contacts	* Edge-wise and frequent long contacts
* No pressure solution observed	* No verified pressure solution observed (indications of secondary growth of silica)

The conclusion is thus that investigated materials do not yield pressure solution and precipitation of silica at a temperature of 115°C and a pressure of 200 bar over a period of 70 days.

7 REFERENCES

- 1 Björlykke, K., 1983: Diagenetic reactions in sandstones. In Sediment Diagenesis ed by A. Parker & B.W. Sellwood. 169-213. D. Reidel Publishing Company
- 2 Maxwell, J.C., 1960: Experiments on compaction and cementation of sand. Geological Society of America, Memoirs 79, 105-132.
- 3 Penton, J.J., Heald, M.T., and Cecil, C.B., 1969: Experimental investigation of pressure solution of quartz. Journal of Sedimentary Petrology 39, 1107-1117
- 4 Wolf, K.H., and Chilingarian, G.V., (Eds) 1976: Compaction of coarse grained sediments, II. Developments in sedimentology 18 B, pp 808. Elsevier scientific publishing company
- 5 De Boer, R.B., Nagtegaal, P.J.C., and Duuis, E.M., 1977. Pressure solution experiments on quartz sand. Geochima et Cosmochimica Acta, 41, 257-264
- 6 Lea, F.M., 1949: Disc. Faraday Society 5, 289
- 7 Correns, C.W., 1949: Disc. Faraday Society 5, 267
- 8 Taylor, I.M., 1950: Pore space reduction in sandstones. American Association of Petroleum Geologists Bulletin, 34
- 9 Heald, M.T., 1956: Cementation of Simpson and St Peter sandstones in parts of Oklahoma, Arkansas, and Missouri. Journal of Geology, 64, 16-30
- 10 Siever, R., 1959: Petrology and geochemistry of silica cementation in some Pennsylvanian sandstones. In Silica in Sediments ed by H.I. Ireland, Society of Economic Petrology and Mineralogy, Special Publication 7, 55-79

- 11 Kahn, J.S., 1956: The analysis and distribution of the properties of packing in sand-size sediments, 1. On the measurement of packing in sandstones. Journal of Geology, 64, 385-395