

Forsmark Site Investigation

RAMAC and BIPS logging in borehole KFM04A, KFM04B, HFM09 and HFM10

Jaana Gustafsson, Christer Gustafsson
Malå Geoscience AB / RAYCON

April 2004

Svensk Kärnbränslehantering AB

Swedish Nuclear Fuel
and Waste Management Co
Box 5864
SE-102 40 Stockholm Sweden
Tel 08-459 84 00
+46 8 459 84 00
Fax 08-661 57 19
+46 8 661 57 19



Forsmark Site Investigation

RAMAC and BIPS logging in borehole KFM04A, KFM04B, HFM09 and HFM10

Jaana Gustafsson, Christer Gustafsson
Malå Geoscience AB / RAYCON

April 2004

Keywords: BIPS, RAMAC, Radar, TV, Geophysical logging, AP PF-400-03-45,
Field note no Forsmark 154; 156; 162.

This report concerns a study which was conducted for SKB. The conclusions and viewpoints presented in the report are those of the authors and do not necessarily coincide with those of the client.

A pdf version of this document can be downloaded from www.skb.se

Contents

1	Introduction	5
2	Objective and scope	7
3	Equipment	9
3.1	Borehole radar – RAMAC	9
3.2	TV-Camera – BIPS	10
4	Execution	11
4.1	Data acquisition	11
4.2	Analyses and interpretation	14
5	Results and data delivery	17
5.1	RAMAC logging	17
5.2	BIPS logging	27
6	References	31
Appendix 1	Radar logging of KFM04A, 10 to 100 m	33
	Dipole antennas 250, 100 and 20 MHz	33
Appendix 2	Radar logging of KFM04A, 100 to 1000 m	35
	Dipole antennas 250 and 100 MHz	35
Appendix 3	Radar logging of KFM04A, 100 to 1000 m	45
	Dipole antenna 20 MHz	45
Appendix 4	Radar logging of KFM04B, 0 to 100 m	49
	Dipole antennas 250, 100 and 20 MHz	49
Appendix 5	Radar logging of HFM09, 0 to 50 m	51
	Dipole antennas 250 and 100 MHz	51
Appendix 6	Radar logging of HFM10, 0 to 150 m	53
	Dipole antennas 250, 100 and 20 MHz	53
Appendix 7	BIPS logging of KFM04A, 11 to 106.8 m	55
Appendix 8	BIPS logging of KFM04A, 108 to 997.6 m	63
Appendix 9	BIPS logging of KFM04A, 910 to 986 m	111
Appendix 10	BIPS logging of KFM04B, 10 to 99.9 m	117
Appendix 11	BIPS logging of HFM09, 16 to 49.8 m	123
Appendix 12	BIPS logging of HFM10, 11 to 148.9 m	127

1 Introduction

This document reports data gained during geophysical logging, which is one of the activities performed within the site investigation at Forsmark. The logging operations presented here include borehole radar (RAMAC) and TV-logging (BIPS) in the core and percussion drilled boreholes KFM04A, KFM04B, HFM09 and HFM10. They are all located at drill site 4 (see Table 1-1 and Figure 1-1).

Table 1-1. Investigated boreholes. The orientation of KFM04B is preliminary.

Borehole ID	Azimuth (degrees from north)	Inclination (degrees from horizontal)	Length (m)	Investigated section (m)
KFM04A	45	45 / 60	1001	10–1000
KFM04B	225 (prel)	60 (prel)	100	0–100
HFM09	139	69	50	0–50
HFM10	93	69	150	0–150

The borehole radar measurements and BIPS measurements were conducted by Malå Geoscience AB / RAYCON during June, August, September and December 2003 according to activity plan AP-400-03-45 (SKB internal controlling document).

It should be noted that when the logging was performed KFM04B was denominated KFM06, which also is reflected in the activity plan.

The applied investigation techniques comprised:

- Borehole radar with both dipole and directional radar antennas.
- Borehole TV logging with the so-called BIP-system (Borehole Image Processing System), which is a high resolution, side viewing, colour borehole TV system.

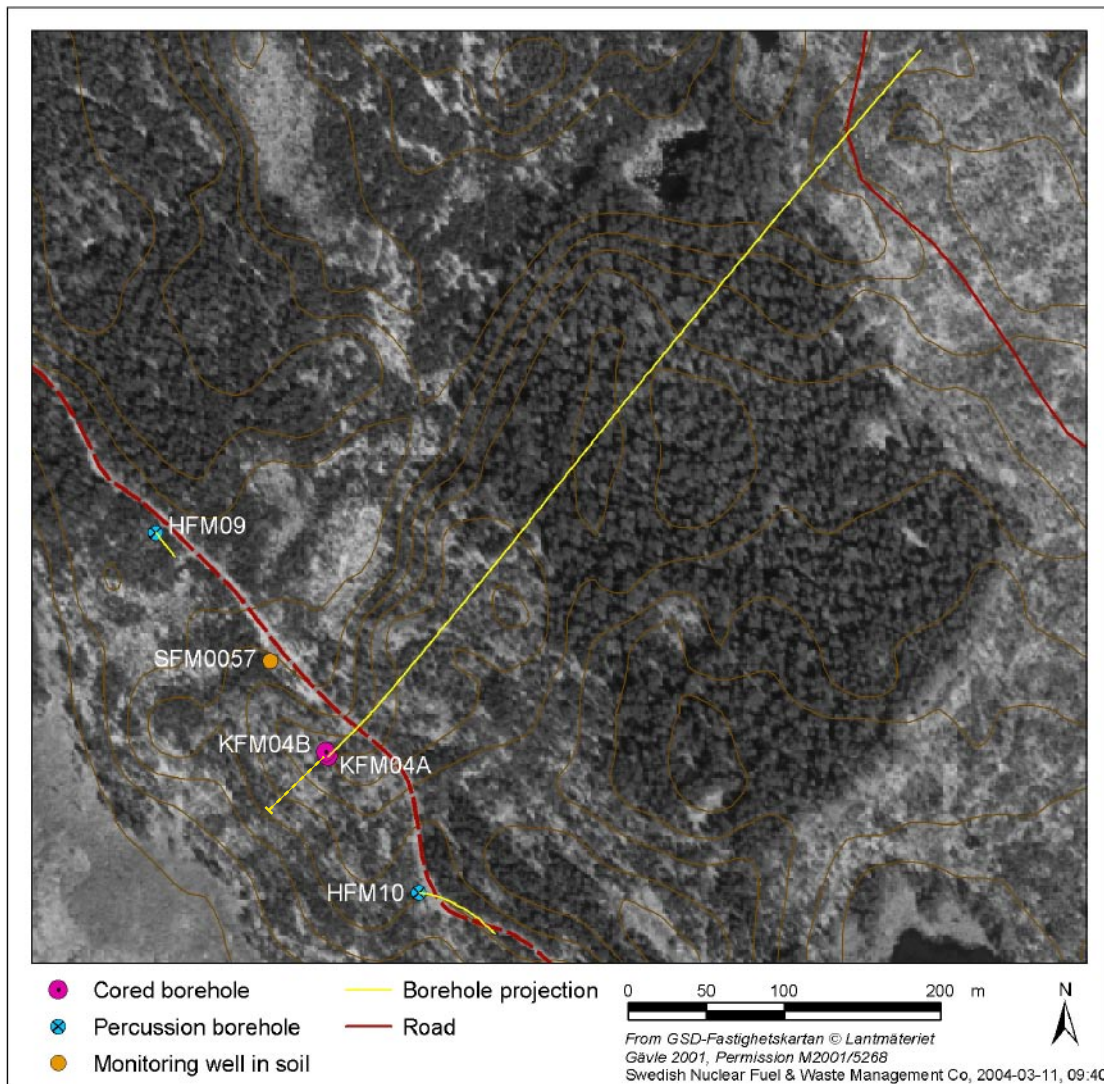

Figure I-1. Overview of drill site no 4 in the Forsmark area. Note that the projection of KFM02, dashed line, is the intended projection. (The true orientation of the borehole had not been measured when the present report was prepared).

2 Objective and scope

The objective of the radar- and BIPS-surveys was to achieve information on the borehole conditions (borehole wall) as well as on the rock mass around the borehole. Borehole radar was engaged to investigate the nature and the structure of the rock mass enclosing the boreholes, and borehole TV for geological surveying of the borehole including determination of fracture distribution and orientation.

This report describes the equipment used as well the measurement procedures and data gained.

3 Equipment

3.1 Borehole radar – RAMAC

The RAMAC GPR system owned by SKB is fully digital, and emphasis has been laid on high survey speed and smooth field operation. The system operates dipole and directional antennas (see Figure 3-1). A system description is given in the method description “Metodbeskrivning för borrhålsradar” (SKB MD 252.21, Version 1.0).

The borehole radar system consists of a transmitter and a receiver. During operation, an electromagnetic pulse, within the frequency range 20 to 250 MHz, is emitted and penetrates the bedrock. The resolution and penetration of the radar waves depend on the antenna frequency used. A low antenna frequency results in lower resolution but higher penetration rate compared to a higher frequency. If a feature, e.g. a water-filled fracture, with anomalous electrical properties compared to the surrounding is encountered, the pulse is reflected back to the receiver and recorded.

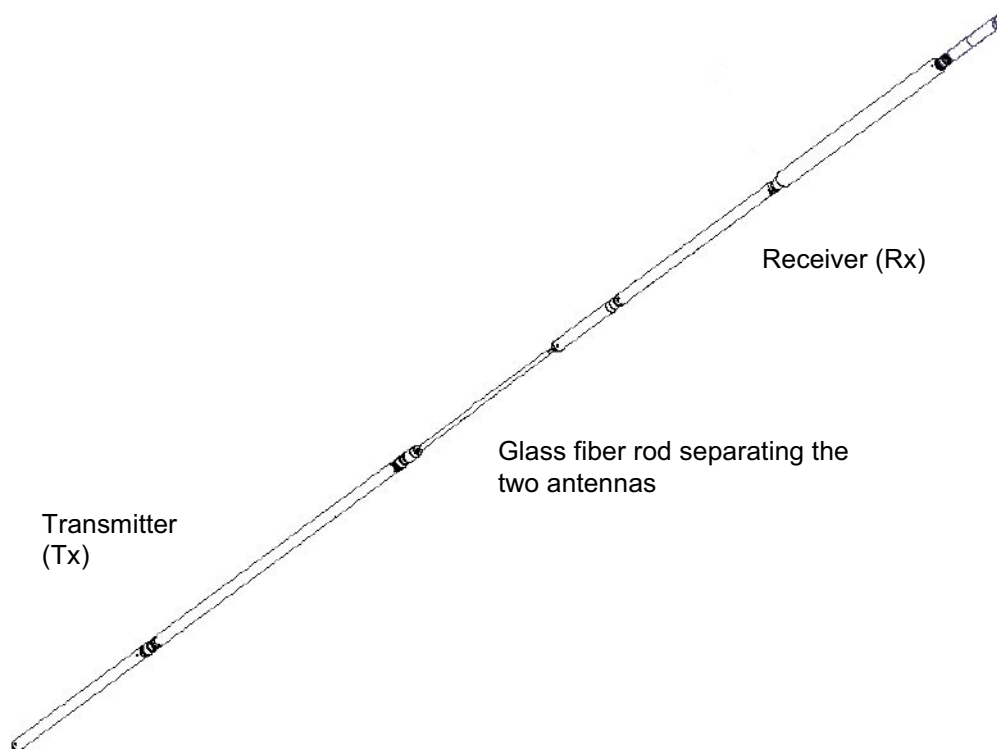

Figure 3-1. Example of a borehole antenna.

3.2 TV-Camera – BIPS

The BIPS 1500 system used is owned by SKB and described in the method description “Metodbeskrivning för TV-loggning med BIPS” (SKB MD 222.005, Version 1.0). The BIPS method for borehole logging produces a digital scan of the borehole wall. In principle, a standard CCD video camera is installed in the probe in front of a conical mirror (see Figure 3-2). An acrylic window covers the mirror part and the borehole image is reflected through the window and displayed on the cone, from where it is recorded. During the measuring operation, pixel circles are grabbed with a resolution of 360 pixels/circle.

The BIPS images can be orientated by means of two alternative methods, either with a compass (vertical and sub-vertical boreholes) or with a gravity sensor (inclined boreholes).

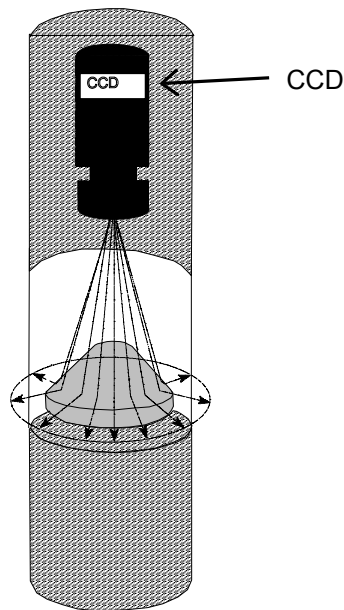

Figure 3-2. The BIP-system. Illustration of the conical mirror scanning.

4 Execution

4.1 Data acquisition

RAMAC

For the borehole radar measurements, dipole antennas were engaged in all boreholes. The dipole antennas used have central frequencies of 20 MHz, 100 MHz and 250 MHz respectively. In KFM04A (100 to 1000 m), measurements were also made with a directional antenna, with a central frequency of 60 MHz.

During logging, the dipole antennas (transmitter and receiver) were lowered continuously into the borehole and the data recorded on a field PC. The measurements with the directional antenna are made step-wise, with a short pause for each measurement occasion. The antennas are kept at a fixed separation by glass fibre rods according to Table 4-1 to 4-5. See also Figure 3-1 and 4-1.

For detailed information see the SKB MD 252.020 for method description and MD 600.004 (“Instruktion för rengöring av borrhålsutrustning och viss markbaserad utrustning”) for cleaning of equipment.

Information on the system settings for the different antennas used in the investigation of KFM04A, KFM04B, HFM09 and HFM10 is presented in Table 4-1 to 4-5 below.

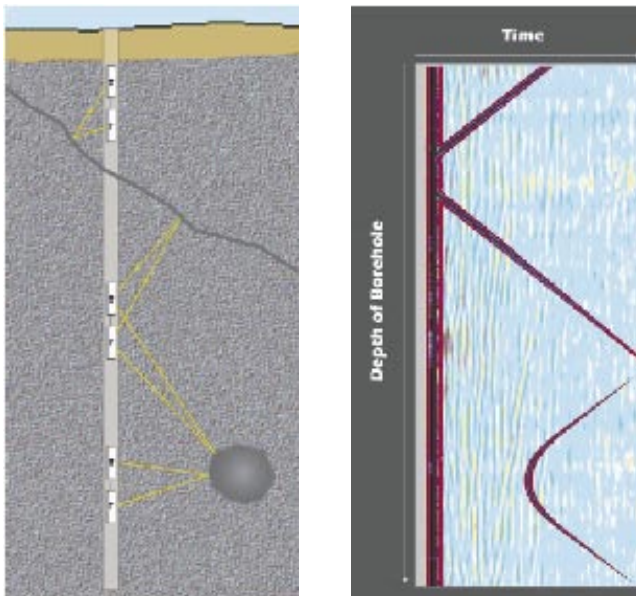

Figure 4-1. The principle of radar borehole reflection survey (left) and a resulting radargram (right).

Table 4-1. Radar logging information from KFM04A, 0 to 100 m, Forsmark.

Site: BH: Type: Operators: CG	Forsmark KFM04A Dipole	Logging company: RAYCON		
		Equipment: SKB RAMAC Manufacturer: MALÅ GeoScience		
Antenna		250 MHz	100 MHz	20 MHz
Logging date:		03-06-03	03-06-03	03-06-03
Reference:		T.O.C.	T.O.C.	T.O.C.
Sampling frequency (MHz):		2588	951	257
Number of samples:		619	518	518
Number of stacks:		Auto	Auto	Auto
Signal position:		-0.32	-0.32	-1.43
Logging from (m):		12.2	12.6	16.25
Logging to (m):		104.9	104.33	100.2
Trace interval (m):		0.1	0.2	0.25
Antenna separation (m):		2.4	3.9	10.05

Table 4-2. Radar logging information from KFM04A, 100 to 1000 m, Forsmark.

Site: BH: Type: Operators: CG	Forsmark KFM04A Directional / Dipole	Logging company: RAYCON			
		Equipment: SKB RAMAC Manufacturer: MALÅ GeoScience			
Antenna		Directional	250 MHz	100 MHz	20 MHz
Logging date:		03-12-07	03-12-07	03-12-07	03-12-07
Reference:		T.O.C.	T.O.C.	T.O.C.	T.O.C.
Sampling frequency (MHz):		656	2588	951	257
Number of samples:		512	619	518	518
Number of stacks:		32	Auto	Auto	Auto
Signal position:		365.7	-0.32	-0.32	-1.43
Logging from (m):		113.4	101.5	102.6	106.25
Logging to (m):		988	999.5	999.6	991.25
Trace interval (m):		0.5	0.25	0.2	0.1
Antenna separation (m):		5.73	1.9	2.9	10.05

Table 4-3. Radar logging information from KFM04B.

Site: BH: Type: Operators:	Forsmark KFM04B Dipole CG	Logging company: RAYCON		
		Equipment: SKB RAMAC		
		Manufacturer: MALÅ GeoScience		
		Antenna		
		250 MHz	100 MHz	20 MHz
Logging date:		03-06-03	03-06-03	03-06-03
Reference:		T.O.C.	T.O.C.	T.O.C.
Sampling frequency (MHz):		2588	951	257
Number of samples:		Auto	Auto	Auto
Number of stacks:		619	518	518
Signal position:		-0.32	-0.32	-1.43
Logging from (m):		11.5	12.6	16.25
Logging to (m):		98.34	97.38	92.82
Trace interval (m):		0.1	0.2	0.25
Antenna separation (m):		2.4	3.9	10.05

Table 4-4. Radar logging information from HFM09.

Site: BH: Type: Operators:	Forsmark HFM09 Dipole CG	Logging company: RAYCON	
		Equipment: SKB RAMAC	
		Manufacturer: MALÅ GeoScience	
		Antenna	
		250 MHz	100 MHz
Logging date:		03-08-06	03-08-06
Reference:		T.O.C	T.O.C
Sampling frequency (MHz):		2588	951
Number of samples:		619	518
Number of stacks:		Auto	Auto
Signal position:		-0.32	-0.32
Logging from (m):		1.5	2.6
Logging to (m):		48.02	47.16
Trace interval (m):		0.1	0.2
Antenna separation (m):		2.4	3.9

Table 4-5. Radar logging information from HFM10.

Site: BH: Type: Operators:	Forsmark HFM10 Dipole CG	Logging company: RAYCON		
		Equipment: SKB RAMAC		
		Manufacturer: MALÅ GeoScience		
		Antenna		
		250 MHz	100 MHz	20 MHz
Logging date:		03-08-30	03-08-30	03-08-30
Reference:		T.O.C.	T.O.C.	T.O.C.
Sampling frequency (MHz):		2588	951	257
Number of samples:		619	518	518
Number of stacks:		Auto	Auto	Auto
Signal position:		-0.32	-0.32	-1.43
Logging from (m):		1.5	2.6	6.25
Logging to (m):		147.79	146.87	142.72
Trace interval (m):		0.1	0.2	0.25
Antenna separation (m):		2.4	3.9	10.05

BIPS

For detailed information on BIPS measurements see the SKB MD 222.006 for a method description and MD 600.004 for cleaning of equipment.

During the measurement, pixel circles with a resolution of 360 pixels/circle were recorded and the digital circles were stored at every 1 mm on a MO-disc in the surface unit. The maximum speed during data collection was 1.5 m/minute.

All boreholes presented in this report are inclined (60–70 degrees from horizontal) and, therefore, the gravity sensor was used to orientate the BIPS camera.

Depth measurements

The depth recording for the RAMAC and BIPS systems is taken care of by a measuring wheel mounted on the cable winch. During logging in core drilled boreholes, reference marks in the boreholes are visible on the BIPS image. To control the depth recording during the RAMAC logging, the logging cable is marked with a piece of scotch tape for every single depth mark. These marks are then used for depth control of both the BIPS and RAMAC loggings in percussion drilled boreholes, where there are no reference marks.

KFM04B, HFM09 and HFM10 are less than 150 m deep, giving a very slight divergence in the depth measurements. The depth divergence for KFM04A was less than 35 cm in the deepest parts.

4.2 Analyses and interpretation

Radar

The results from radar measurements are commonly presented in the form of a radargram, where the position of the probes is displayed along one axis and the propagation along the other. The amplitude of the received signal is shown with a grey scale where black colour corresponds to the large positive signals and white colour to large negative signals. Grey colour corresponds to no reflected signal.

The data presented in this report is related to the “measurement point”, which is defined to be the central point between the transmitter and the receiver antenna.

In the reflection mode, borehole radar primarily offer a high-resolution image of the rock mass, visualizing the geometry of plane structures (contacts between rock units of different lithology, thin marker beds, fractures, fracture zones etc), which may or may not intersect the borehole, or showing the presence of local features (cavities, lenses etc) around the borehole.

The distance to a reflecting object or plane is determined by measuring the difference in arrival time between the direct and the reflected pulse. The basic assumption is that the speed of propagation is consistent in the rock volume investigated.

There are several ways to determine the radar wave propagation velocity. Each of them has its advantages and its disadvantages. In this project, the velocity determination was performed by keeping the transmitter fixed in a borehole at drill site no 1 (the percussion drilled borehole HFM03) while moving the receiver downwards in the borehole. The result is plotted in Figure 4-2. The calculation shows a velocity of 128 m/micro seconds. The velocity measurement was performed with the 100 MHz antenna /1/.

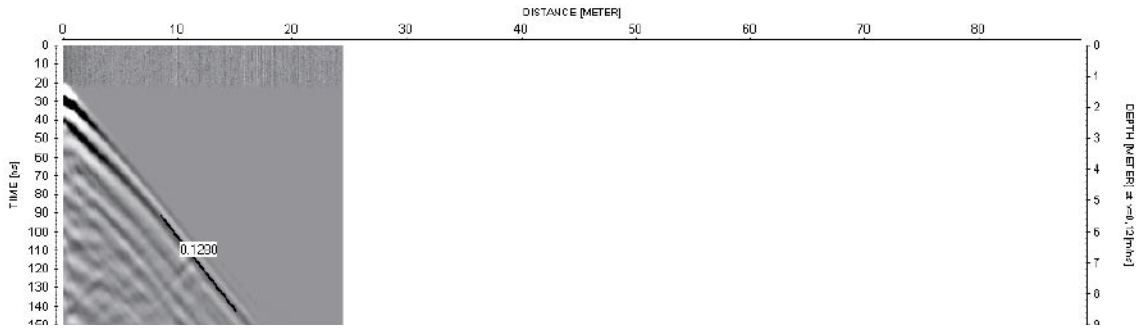

Figure 4-2. Results from velocity measurements in HFM03 //1/.

The visualization of data in Appendix 1 to 6 is made with REFLEX, a Windows based processing software for filtering and analysis of radar data. The processing steps are shown in Table 4-6 to 4-10.

For the interpretation of the intersection angle between the borehole axis and the planes visible on the radargrams the RadinterSKB software has been applied. RadinterSKB is also used to interpret the orientation of structures identified in the directional antenna data. The interpreted intersection points and intersection angles of the detected structures are presented in the Table 5-5 to 5-9 and also visible on the radargrams in Appendix 1 to 6.

Table 4-6. Processing steps for borehole radar data from KFM04A, 0 to 100 m.

Site:	Forsmark	Logging company:	RAYCON		
BH:	KFM04A	Equipment:	SKB RAMAC		
Type:	Dipole	Manufacturer:	MALÅ GeoScience		
Interpret:	JG	Antenna	250 MHz	100 MHz	20 MHz
Processing:	DC removal	DC removal	DC removal	DC removal	DC removal
	Move start time	Move start time	Move start time	Move start time	Move start time
	Gain	Gain	Gain	Energy decay and Dewow	Energy decay and Dewow

Table 4-7. Processing steps for borehole radar data from KFM04A, 100 to 1000 m.

Site:	Forsmark	Logging company:	RAYCON			
BH:	KFM04A	Equipment:	SKB RAMAC			
Type:	Directional / Dipole	Manufacturer:	MALÅ GeoScience			
Interpret:	JG	Antenna	Directional	250 MHz	100 MHz	20 MHz
Processing:	DC removal	DC removal	DC removal	DC removal	DC removal	DC removal
	FIR	Move start time	Move start time	Move start time	Move start time	Move start time
	Time gain	Gain	Gain	Gain	Gain	Gain

Table 4-8. Processing steps for borehole radar data from KFM04A.

Site:	Forsmark	Logging company:	RAYCON	
BH:	KFM04A	Equipment:	SKB RAMAC	
Type:	Dipole	Manufacturer:	MALÅ GeoScience	
Interpret:	JG	Antenna	250 MHz	100 MHz 20 MHz
	Processing:	DC removal	DC removal	DC removal
		Move start time	Move start time	Move start time
		Gain	Gain	Energy decay and Dewow

Table 4-9. Processing steps for borehole radar data from HFM09.

Site:	Forsmark	Logging company:	RAYCON	
BH:	HFM09	Equipment:	SKB RAMAC	
Type:	Dipole	Manufacturer:	MALÅ GeoScience	
Interpret:	JG	Antenna	250 MHz	100 MHz
	Processing:	DC removal	DC removal	
		Move start time	Move start time	
		Gain	Gain	

Table 4-10. Processing steps for borehole radar data from HFM10.

Site:	Forsmark	Logging company:	RAYCON	
BH:	HFM10	Equipment:	SKB RAMAC	
Type:	Dipole	Manufacturer:	MALÅ GeoScience	
Interpret:	JG	Antenna	250 MHz	100 MHz 20 MHz
	Processing:	DC removal	DC removal	DC removal
		Move start time	Move start time	Move start time
		Gain	Gain	Energy decay and Dewow

BIPS

The visualization of data is made with BDPP (see Appendix 7–11), a Windows based processing software for filtering, presentation and analyzing of BIPS data. No fracture mapping of the BIPS image was performed.

5 Results and data delivery

The results from the radar and BIPS measurements were delivered as raw data (*.bip-files) on CD-ROMs to SKB together with printable BIPS pictures in *.pdf format before the field crew left the investigation site. The information of the measurements is registered in SICADA and the VHS-tapes, MO-disks and CD-ROMs are stored by SKB.

RAMAC radar data was been delivered as raw data (fileformat *.rd3 or *.rd5) with corresponding information files (file format *.rad), whereas the data processing steps and results are presented in this report. Relevant information, including the interpretation presented in this report, was inserted into the SKB database SICADA.

The SICADA reference to the BIPS and RAMAC logging activities in KFM04A, KFM04B, HFM09 and HFM10 is Field note Forsmark No. 154, 155 and 162.

5.1 RAMAC logging

The functionality of the directional antenna was tested before the measurements were carried out. This was done by measuring in the air. While measuring, the position of the receiver antenna is turned and this way the direction to the transmitter antenna is determined. The difference in direction measured by compass and the result achieved from the directional antenna was about 10 degrees. This is considered to be satisfying, taking into account the somewhat disturbed environment at the site.

The results of the interpretation of the radar measurements are presented in Table 5-1 to 5-9. Radar data is also visualized in Appendix 1 to 6. It should be remembered that the images in Appendix 1 to 4 are only composite pictures of all events, 360 degrees around the borehole, and do not reflect the true orientation of the structures.

Only the major, clearly visible structures are interpreted in RadinterSKB. A number of minor structures were encountered as well, as indicated in Appendix 1 to 6.

The data quality, as seen in Appendix 1 to 6, is relatively satisfying. However, the measurements in parts of the boreholes suffer from deteriorated quality due to increased electrical conductivity in the rock or borehole fluid. A conductive environment entails attenuation of the radar waves, resulting in decreased penetration.

As also seen in Appendix 1 to 6, the resolution and penetration of the radar waves depend of the antenna frequency used. A high frequency will result in a high resolution but a lower penetration rate compared to a lower frequency.

Table 5-1. Identified structures as a function of depth in KFM04A.

Depth (m)	No of structures
0 – 50	8
50 – 100	10
100 – 150	10
150 – 200	10
200 – 250	8
250 – 300	5
300 – 350	7
350 – 400	6
400 – 450	6
450 – 500	7
500 – 550	6
550 – 600	6
600 – 650	4
650 – 700	3
700 – 750	5
750 – 800	4
800 – 850	6
850 – 900	8
900 – 950	6
950 –	5

Table 5-2. Identified structures as a function of depth in KFM04B.

Depth (m)	No of structures
20 – 30	4
30 – 40	2
40 – 50	4
50 – 60	3
60 – 70	2
70 – 80	1
80 – 90	4
90 – 100	2
100 –	3

Table 5-3. Identified structures as a function of depth in HFM09.

Depth (m)	No of structures
20 – 30	2
30 – 40	1
40 – 50	2

Table 5-4. Identified structures as a function of depth in HFM10.

Depth (m)	No of structures
10 – 20	1
20 – 30	2
30 – 40	1
40 – 50	2
50 – 60	1
60 – 70	3
70 – 80	3
80 – 90	3
90 – 100	–
100 –	6

Table 5-5 to 5-9 summarise the interpretation of radar data from KFM04A, KFM04B, HFM09 and HFM10. Many structures can be identified in the data from more than one antenna frequency. When an object (in this case plane) is detected by the directional antenna (data only from KFM04A 100 to 1000 m) the direction to the plane, as defined in Figure 5-1, is interpreted. Based in this information, the true orientation (strike and dip) of the plane can be interpreted, see Table 5-6. In some cases, however, there is an uncertainty (± 180 degrees) in the interpretation of the direction to the plane. Object direction 1, strike 1 and dip 1 in Table 5-6 then represent the most probable interpretation.

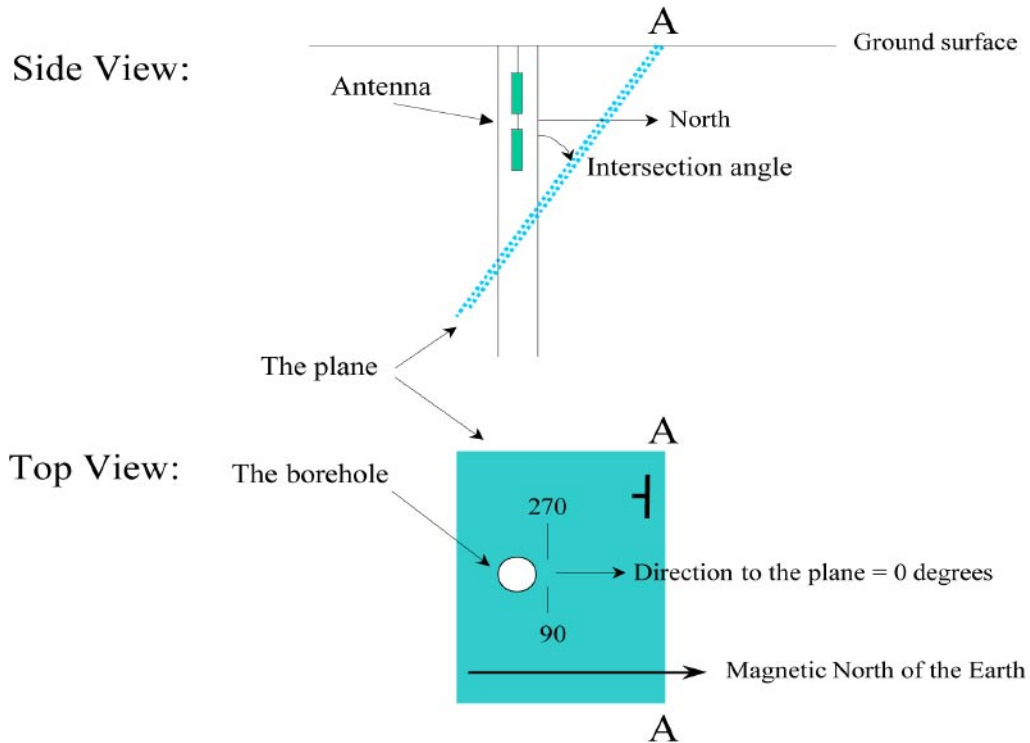

Figure 5-1. Definition of direction to object as presented in Table 5-6.

Table 5-5. Model information from dipole antennas 20, 100 and 250 MHz, KFM04A, 0 to 100 m.

RADINTER MODEL INFORMATION (20, 100 and 250 MHz Dipole Antennas)			
Site:	Forsmark		
Borehole name:	KFM04A		
Nominal velocity (m/μs):	128.00		
Object type	Name	Intersection depth	Intersection angle
PLANE	A	20.1	45
PLANE	B	21.3	53
PLANE	C	23.9	51
PLANE	D	34.3	49
PLANE	DD	38.3	68
PLANE	E	41.2	62
PLANE	F	45.8	58
PLANE	G	52.4	50
PLANE	FF	56.8	45
PLANE	H	64.8	43
PLANE	I	69.6	39
PLANE	J	71.7	43
PLANE	K	79.7	44
PLANE	L	82	53
PLANE	M	85.2	46
PLANE	N	90.3	52
PLANE	O	99.5	66
PLANE	P	103.8	82
PLANE	Q	115.2	58

Names in table according to Appendix 1.

Table 5-6. Model information from dipole antennas 20, 100 and 250 MHz and directional antenna, 60 MHz, KFM04A, 100 to 1000 m.

RADINTER MODEL INFORMATION

(20, 100 and 250 MHz Dipole Antennas and Directional Antenna)

Site:		Forsmark							
Borehole name:		KFM04A							
Nominal velocity (m/ μ s):		128.00							
Object type	Name	Intersection depth (m)	Intersection angle (deg)	Object direction 1 (deg)	Object direction 2 (deg)	Interpreted true orientation Strike 1 (deg)	Dip 1 (deg)	Strike 2 (deg)	Dip 2 (deg)
PLANE	83	9	10						
PLANE	A	110.7	64						
PLANE	B	120.3	38						
PLANE	C	126.9	37						
PLANE	D	132.4	46	186	6	220	19	51	71
PLANE	E	135.4	34						
PLANE	F	141.6	38						
PLANE	G	143.8	43						
PLANE	H	149.7	38						
PLANE	I	153.8	46	195		197	17		
PLANE	J	156.3	38	3	183	51	80	227	24
PLANE	K	162.8	41						
PLANE	N	168.6	55						
PLANE	L	170.9	31	192		214	32		
PLANE	M	176.1	27						
PLANE	O	185	46	0		54	73		
PLANE	P	188.9	51						
PLANE	Q	192.7	49						
PLANE	R	196	47						
PLANE	S	200.2	46	198		15	183		
PLANE	T	205.9	46	3		52	73		
PLANE	U	208.6	48						
PLANE	V	210.9	49	183		224	11		
PLANE	W	222.6	50						
PLANE	X	230.8	49	198		181	14		
PLANE	Y	234.7	61	18	198	44	57	136	9
PLANE	Z	246.6	49						
PLANE	1	252.5	56	174		271	6		
PLANE	2	264.7	48						
PLANE	3	271.9	51	24		39	68		
PLANE	4	282.5	44						
PLANE	5	294.8	41						
PLANE	6	304.2	45						
PLANE	81	308.1	10						
PLANE	7	311	46						
PLANE	8	319.1	43						
PLANE	9	321.6	52	192		194	12		
PLANE	10	330.3	50						
PLANE	11	340.9	40						

RADINTER MODEL INFORMATION
(20, 100 and 250 MHz Dipole Antennas and Directional Antenna)

Site: Forsmark
Borehole name: KFM04A
Nominal velocity (m/μs): 128.00

Object type	Name	Intersection depth (m)	Intersection angle (deg)	Object direction 1 (deg)	Object direction 2 (deg)	Interpreted true orientation			
						Strike 1 (deg)	Dip 1 (deg)	Strike 2 (deg)	Dip 2 (deg)
PLANE	12	353.9	54	15	195	46	76	164	9
PLANE	84	354.4	5						
PLANE	13	361.7	62	12		49	57		
PLANE	14	370.3	53	78	258	59	3	117	42
PLANE	15	389.3	43						
PLANE	16	392.4	50	30		34	76		
PLANE	17	406.6	43	63	243	15	63	137	41
PLANE	18	412.5	46						
PLANE	24	425	9	129		297	61		
PLANE	19	434.5	54	186		202	7		
PLANE	82	444	11						
PLANE	20	447.6	55	174	354	287	6	60	70
PLANE	21	455.2	51	189		190	8		
PLANE	22	459.3	49						
PLANE	30	459.3	7	85		334	87		
PLANE	25	465.6	39	195		198	19		
PLANE	23	469.8	43	207	27	167	21	37	79
PLANE	26	476.9	39	15		44	84		
PLANE	27	499.4	48	195	15	188	15	45	77
PLANE	28	507.9	47	24		38	77		
PLANE	29	516.6	41	24	204	37	81	174	21
PLANE	31	535.5	55	33		33	74		
PLANE	32	537.4	28						
PLANE	33	542.5	57						
PLANE	34	547.1	43	15		45	80		
PLANE	35	552.6	45						
PLANE	36	571.9	44	207	27	162	20	35	80
PLANE	37	584.9	48	33		33	75		
PLANE	85	591.6	12						
PLANE	38	592.8	46						
PLANE	39	596.3	50	186		189	6		
PLANE	40	609	57	189		97	7		
PLANE	41	616.9	54	204	24	143	15	40	72
PLANE	42	619.4	42	345		68	82		
PLANE	43	632.6	51	189		161	6		
PLANE	44	654.8	55						
PLANE	45	658	48	27		37	78		
PLANE	46	681.1	60	177		40	6		
PLANE	47	704.5	53	42	222	71	71	119	26
PLANE	48	710.8	51						
PLANE	49	726.9	57						

PLANE 50	738.1	56	171		27	10			
PLANE 51	742.5	58							
PLANE 52	752.2	81							
PLANE 53	765.9	50	255	75	110	47	8	63	
PLANE 54	774	58							
PLANE 55	786	51	30		35	80			
PLANE 56	808.2	43	216	36	140	26	28	84	
PLANE 57	827.1	50	207	27	121	18	37	79	
PLANE 58	830.8	38	237		136	43			
PLANE 59	834.9	44	207		140	19			
PLANE 60	841.2	57	216	36	126	24	34	71	
PLANE 61	848.9	25							
PLANE 62	851.6	58	192	12	140	8	74	75	
PLANE 63	854.7	54	234		110	34			
PLANE 64	866.4	46	213		134	26			
PLANE 65	871	49	222		130	28			
PLANE 67	881.4	47	9	189	48	86	136	6	
PLANE 66	883.6	27							
PLANE 68	892.3	45	15		43	86			
PLANE 69	896.1	49	30		34	81			
PLANE 70	901.4	56	57	237	24	66	107	36	
PLANE 71	908.2	55							
PLANE 72	910.4	59	213	33	100	23	37	72	
PLANE 73	919.1	53	207	27	124	18	38	78	
PLANE 74	937.7	61	177	357	49	16	55	72	
PLANE 75	948.8	53							
PLANE 76	957.5	54	129	309	3	32	82	72	
PLANE 77	975.4	53	24		40	79			
PLANE 78	977.9	53							
PLANE 79	986.2	54	24		39	81			
PLANE 80	994.2	41							

Names in table according to Appendix 2 and 3.

Table 5-7. Model information from dipole antennas 20, 100 and 250 MHz, KFM04B.

RADINTER MODEL INFORMATION (20, 100 and 250 MHz Dipole Antennas)			
Site:	Forsmark		
Borehole name:	KFM04B		
Nominal velocity (m/μs):	128.00		
Object type	Name	Intersection depth	Intersection angle
PLANE	W	20.1	29
PLANE	A	23	32
PLANE	B	27.9	32
PLANE	D	29.9	75
PLANE	E	35	71
PLANE	F	38.5	76
PLANE	C	40.7	19
PLANE	G	41.5	79
PLANE	H	45.5	90
PLANE	I	49	60
PLANE	K	53.2	90
PLANE	J	54.6	28
PLANE	O	56.6	58
PLANE	L	61.1	62
PLANE	M	66	57
PLANE	N	75.5	28
PLANE	P	80.2	66
PLANE	V	83.2	66
PLANE	U	85.7	74
PLANE	Q	89.1	68
PLANE	R	92.2	68
PLANE	T	94.9	69
PLANE	Y	119.4	70
PLANE	S	140	15
PLANE	X	204.2	19

Names in table according to Appendix 4.

Table 5-8. Model information from dipole antennas 100 and 250 MHz, HFM09.

RADINTER MODEL INFORMATION (100 and 250 MHz Dipole Antennas)			
Site:	Forsmark		
Borehole name:	HFM09		
Nominal velocity (m/μs):	128.00		
Object type	Name	Intersection depth	Intersection angle
PLANE	A	22.7	90
PLANE	B	26.8	78
PLANE	C	34.9	47
PLANE	D	47.9	73
PLANE	E	48.5	32

Names in table according to Appendix 5.

Table 5-9. Model information from dipole antennas 20, 100 and 250 MHz, HFM10.

RADINTER MODEL INFORMATION (20, 100 and 250 MHz Dipole Antennas)			
Site:	Forsmark		
Borehole name:	HFM10		
Nominal velocity (m/μs):	128.00		
Object type	Name	Intersection depth	Intersection angle
PLANE	B	18.9	37
PLANE	A	20.2	70
PLANE	C	27.1	61
PLANE	D	36.1	28
PLANE	E	41.4	25
PLANE	V	44.6	78
PLANE	F	50.7	29
PLANE	G	66.2	40
PLANE	L	68.8	21
PLANE	H	69	57
PLANE	I	73.5	51
PLANE	M	75.8	34
PLANE	J	78.2	83
PLANE	K	81	85
PLANE	N	85.3	66
PLANE	U	88.8	32
PLANE	O	103.1	70
PLANE	P	109.7	59
PLANE	R	115.8	23
PLANE	Q	116.4	90
PLANE	S	140.1	21
PLANE	T	145.6	63

Names in table according to Appendix 6.

In Appendix 1 to 6, the amplitude of the first arrival is plotted against the depth, for the 250 MHz dipole antennas. The amplitude variation along the borehole indicates changes of the electrical conductivity of the material. A decrease in this amplitude may indicate fracture zones, clay or rock volumes with increases water content. The decrease in amplitude is seen for the following sections in KFM04A:

Depth (m)
15 – 25
35 – 40
45
50
65
70 – 75
80 – 90
110
170 – 175
185
195
205
215
235 – 240
245
295
310
320
340
360
415 – 430
445
455
460
475
570
660
740
830 – 840
855
880
920
960
985

For KFM04B:

Depth (m)
25
35
45
55 – 60
65
85 – 95

For HFM09:

Depth (m)
20
25
35
40

And for HFM10:

Depth (m)
20 – 30
70 – 75
90
95
105
110
115
140

5.2 BIPS logging

The BIPS pictures for KFM04A, KFM04B, HFM09 and HFM10 are presented in Appendix 7 to 12.

To get the best possible depth accuracy, the BIPS images are adjusted to the reference labels on the logging cable. During previously performed logging in core-drilled boreholes, reference labels are attached to the logging cable according to the reference marks on the borehole wall. In percussion drilled boreholes these labels are used as a reference for the depth adjustment. The experience during the IPLU work is that these labels differ very little compared to the results from operations in core drilled boreholes. At present, the cable is labelled at 110, 150 and 200 m.

In order to control the quality of the system, calibration measurements were performed in a test pipe before logging the first borehole and after logging of the borehole. The resulting images displayed with no difference regarding the colours and focus of the images. Results of the test loggings were included in the delivery of the raw data.

The logging of KFM04A (0–100 m) was performed 03-06-02. The diameter of the borehole was at the time of logging 165 mm. Although the visibility was not perfect, it is still possible to perform the geological mapping if there is a difference in colour and brightness of the features to be mapped.

The logging from 100 to 1000 m in KFM04A was first carried out 03-12-05. This run revealed water quality problems and a second run was therefore made 04-03-09. The images from the second run showed a significant improvement of the image quality, due to the better water conditions. From the very deepest part however, 950-1000 m, the images still turned out to be of poor quality and a third logging was carried out 04-05-12. This time, the section 850 - 986 m was logged and images of generally good quality was obtained. At 985 m, the quality of the images started to become significantly impaired and the lowering of the camera difficult, most likely due to mud in the borehole. The operation was therefore discontinued. Images from the section 910 - 986 m are shown in Appendix 9.

Despite the borehole inclination, the camera operated very well during the logging. The speed of the camera synchronized surprisingly well with the movement of the cable-measuring device at surface. Normally, one can expect some problems with the synchronising in deep boreholes due to the higher friction between the cable and the borehole wall. The friction gets higher when there is more cable in the borehole.

The logging of KFM04B was performed 03-06-04 during the same logging campaign as for the percussion drilled part of the KFM04A. The water conditions was not perfect and there are difficulties to map individual thin structures. Not only the water quality is harmful for mapping these thin structures. The relatively big borehole diameter, 165 mm also makes the mapping more difficult.

The borehole HFM09 has been measured twice, since the first logging, 03-08-06, gave very poor images due to poor water quality and mud on the bottom part of the borehole wall. A second logging was performed 03-09-04 and gave much better images. The water quality had improved a lot in the borehole between the first and second logging. The experience so far is that the quality of the water and borehole wall conditions gets much better if the measurements are made 2–3 weeks after the finish of the drilling. See also Figure 5-2.

The logging in HFM10 was performed 03-08-29. The water quality and the visibility of the borehole wall were very good down to a depth of 115 m. From this level and all the way to the bottom, mud is covering most part of the borehole wall. It has to be stated that even if the borehole wall is covered with mud to 50%, mapping with good resolution is possible. The software, BDPP (Bips Data Processing Program) that are used for the orientation of structures only needs 180 degree of the complete 360 degrees picture to orientate plane structures.



Figure 5-2. Example of the improvements of the images between the first and second logging in HFM09.

6 References

- /1/ **Gustafsson C, Nilsson P, 2003.** Geophysical Radar and BIPS logging in borehole HFM01, HFM02, HFM03 and the percussion drilled part of KFM01A. SKB P-03-39. Svensk Kärnbränslehantering AB.

Radar logging of KFM04A, 10 to 100 m

Dipole antennas 250, 100 and 20 MHz

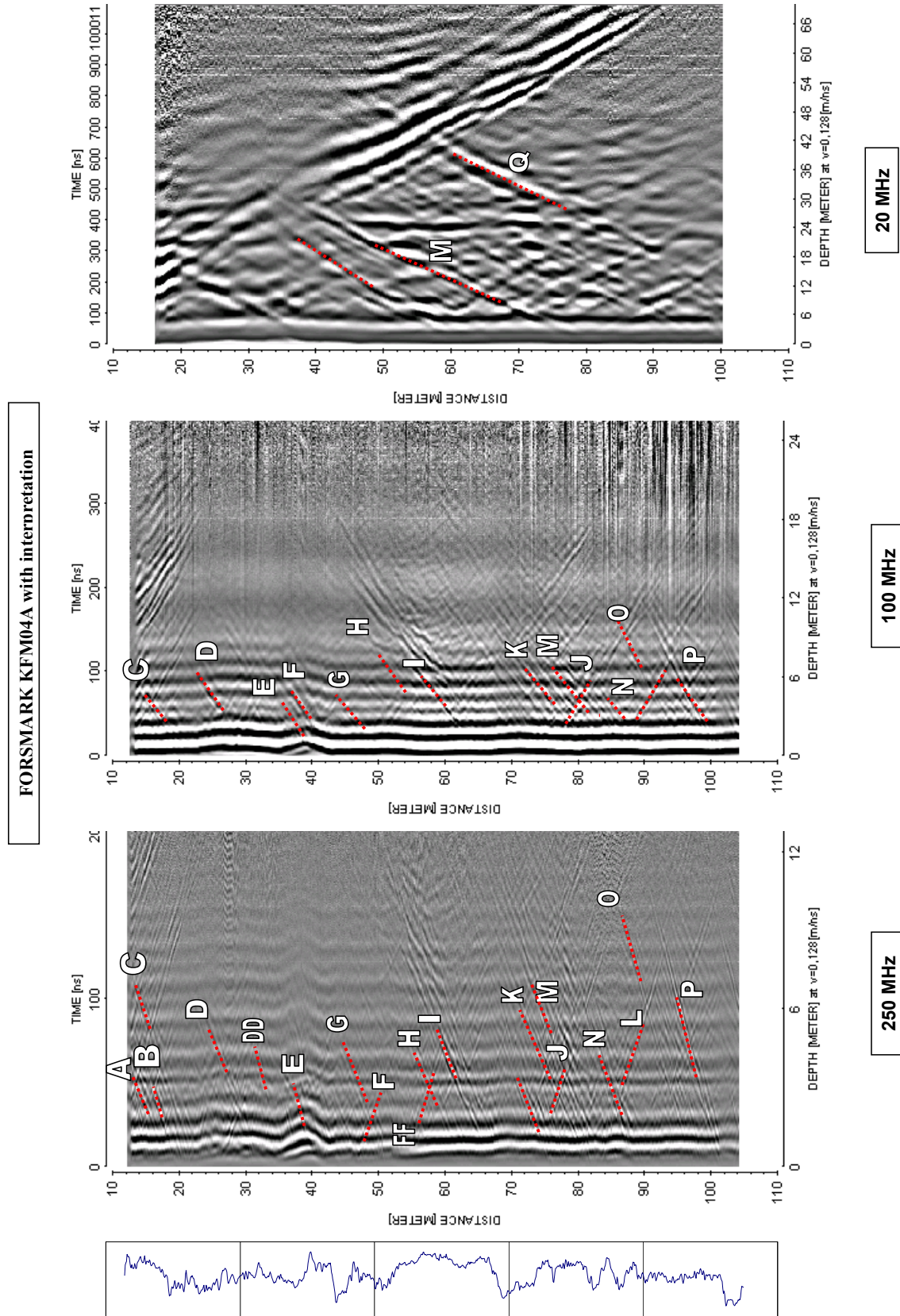

Radar logging of KFM04A, 100 to 1000 m

Dipole antennas 250 and 100 MHz

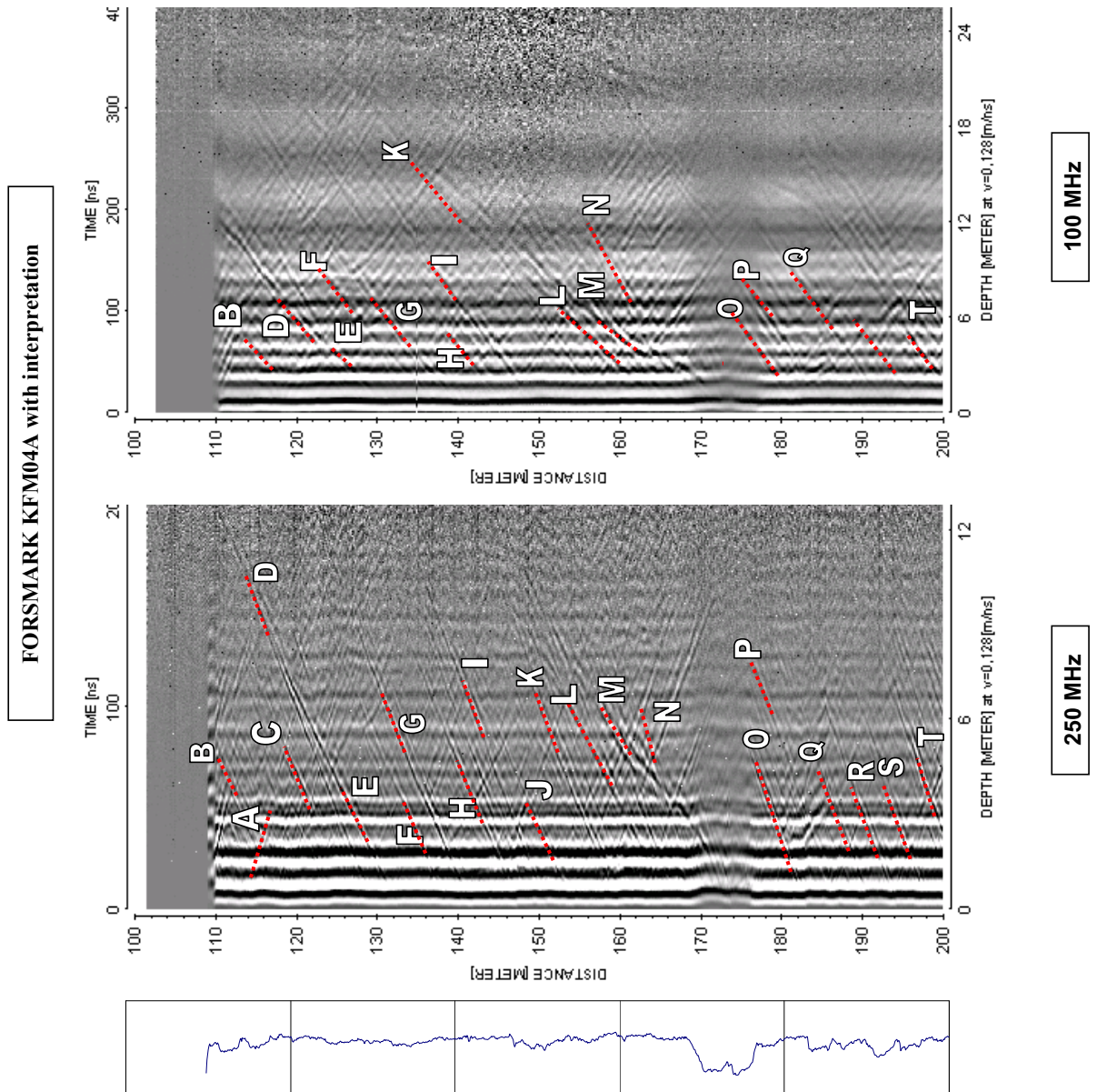

FORSMARK KFM04A with interpretation

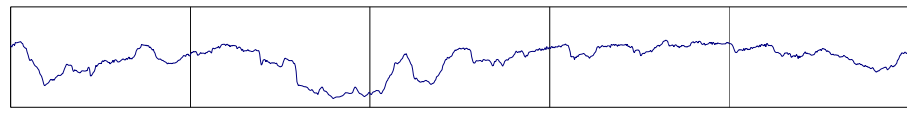
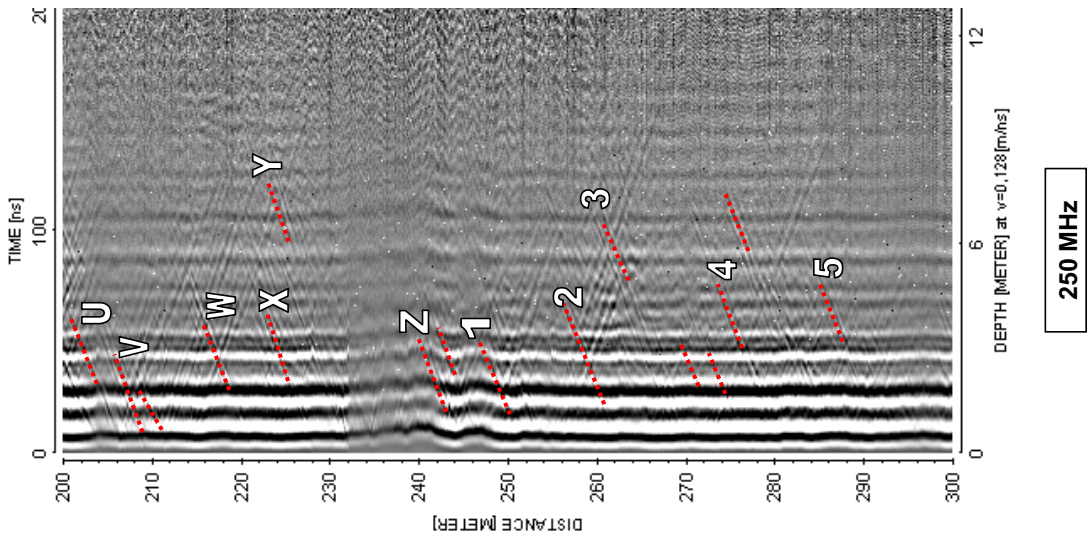
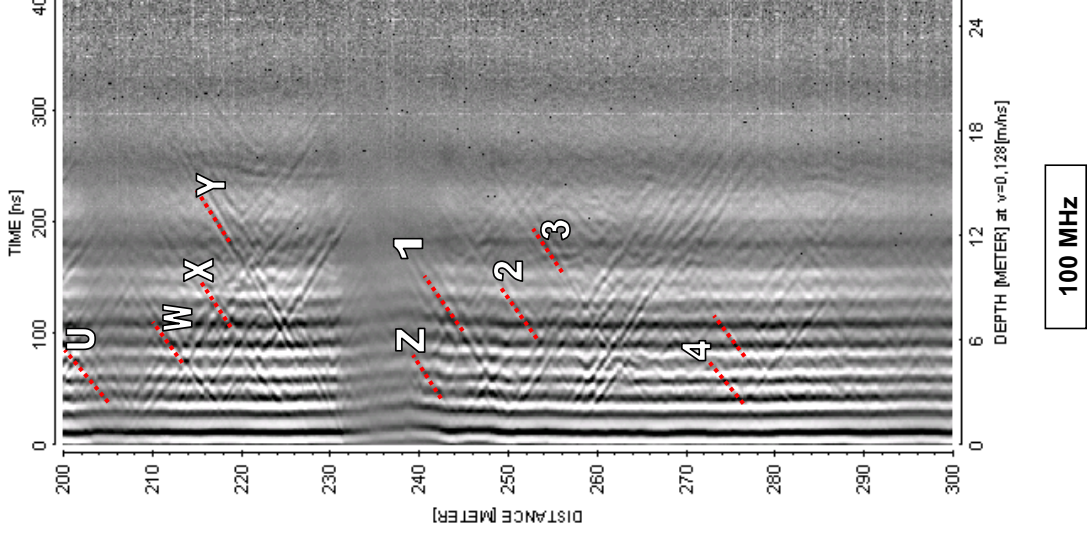

FORSMARK KFM04A with interpretation

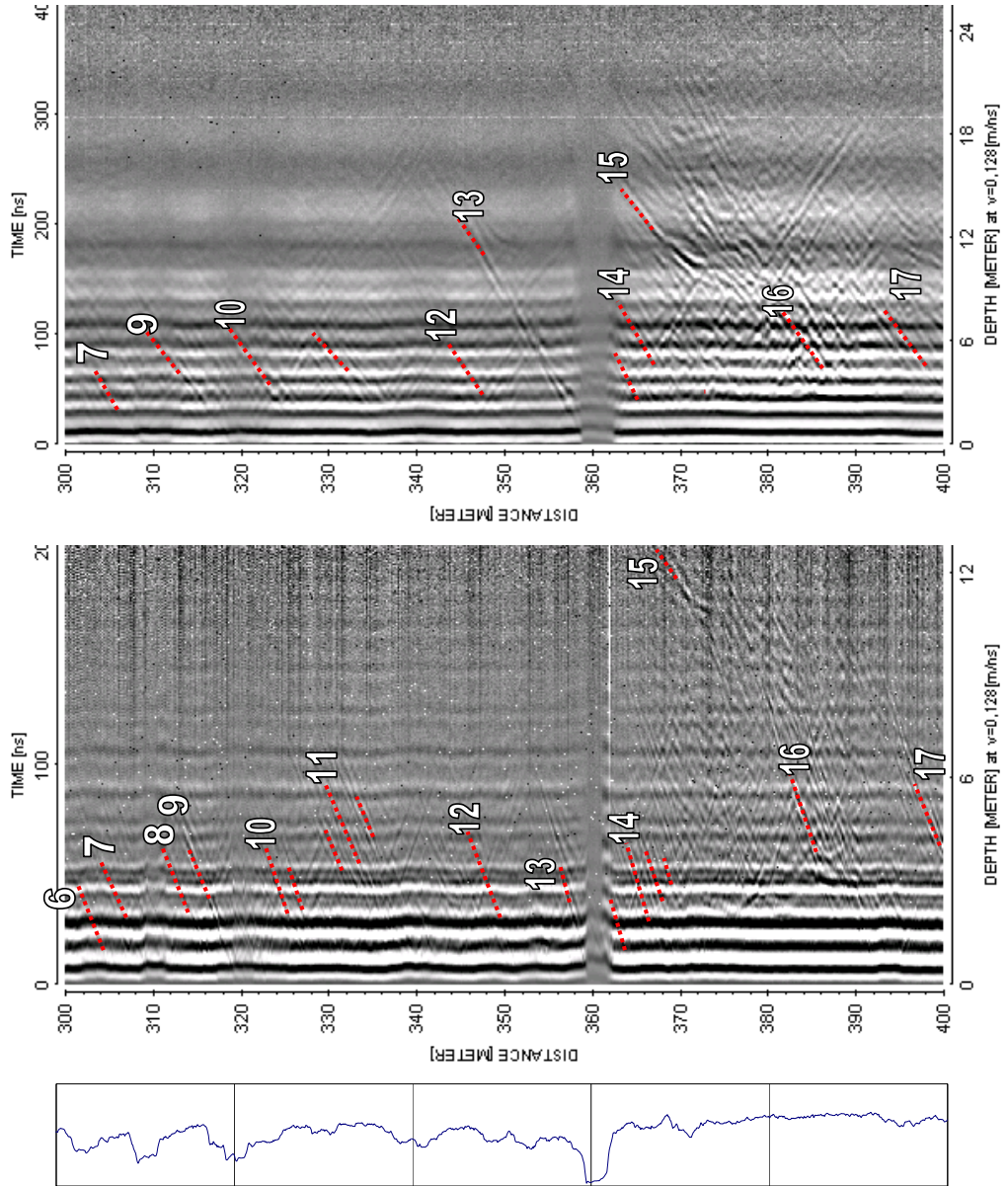

100 MHz

250 MHz

FORSMARK KFM04A with interpretation

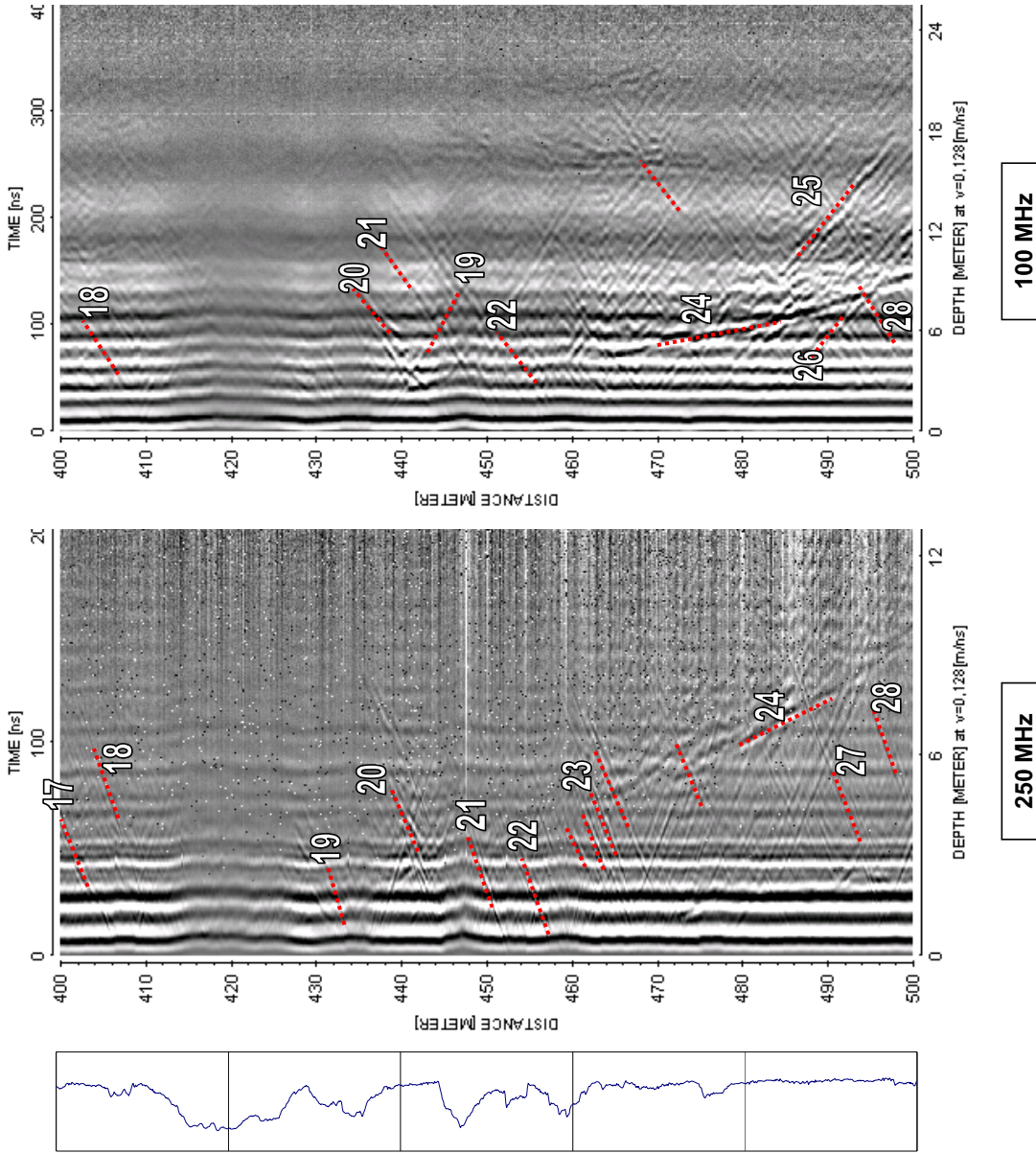

FORSMARK KFM04A with interpretation

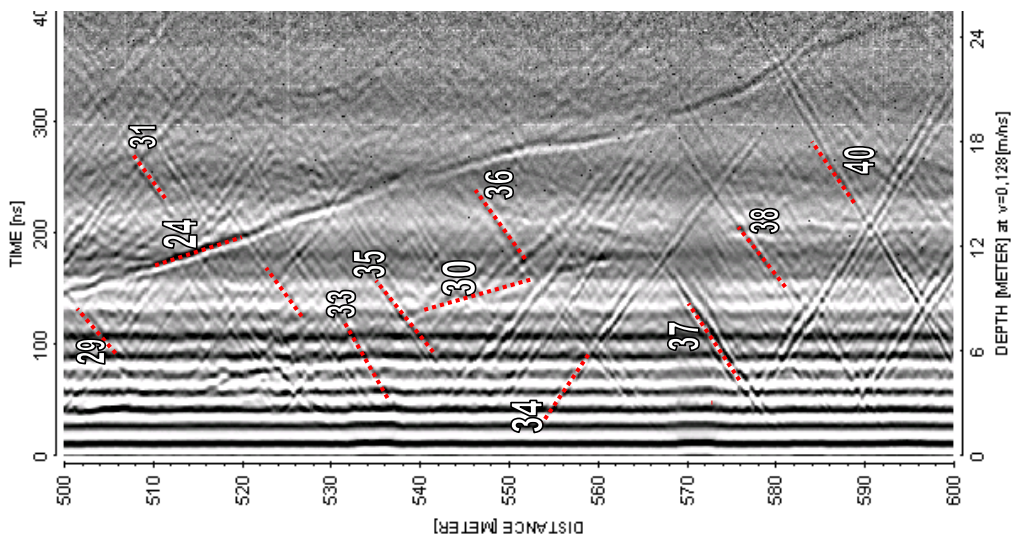

100 MHz

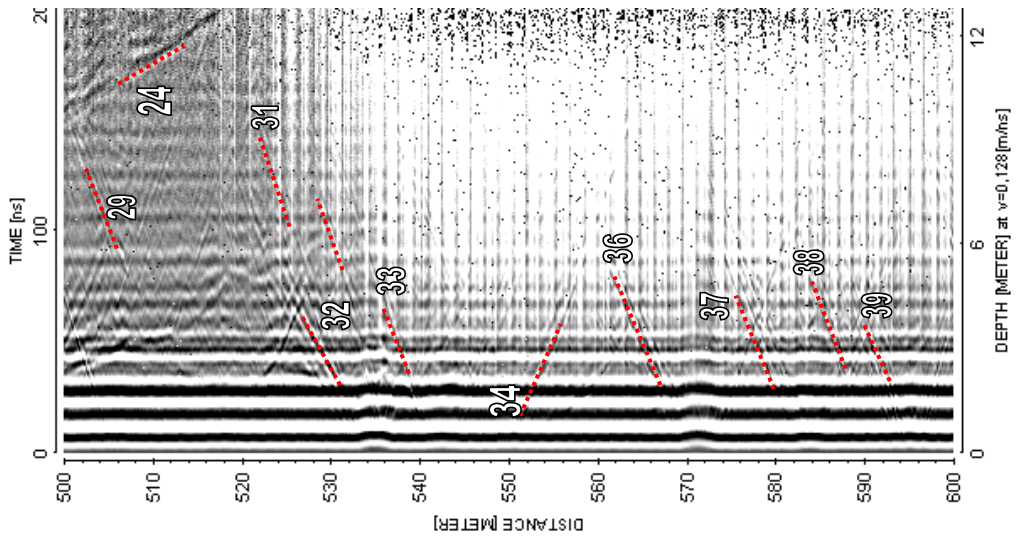

250 MHz

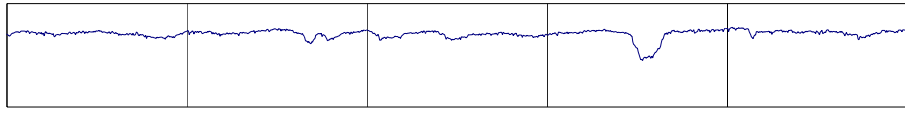

FORSMARK KFM04A with interpretation

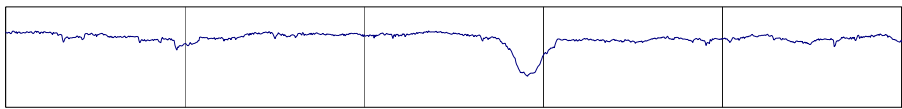
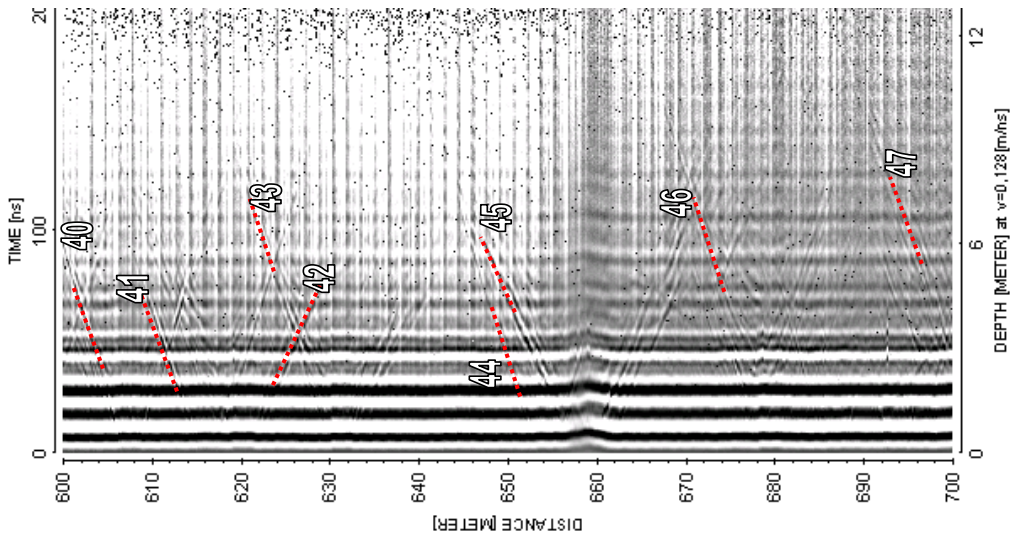
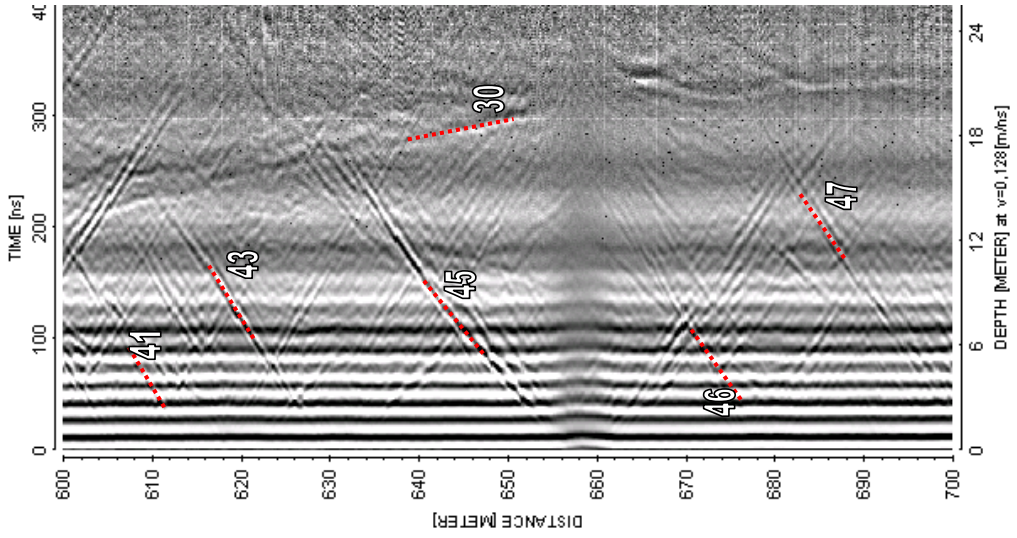

FORSMARK KFM04A with interpretation

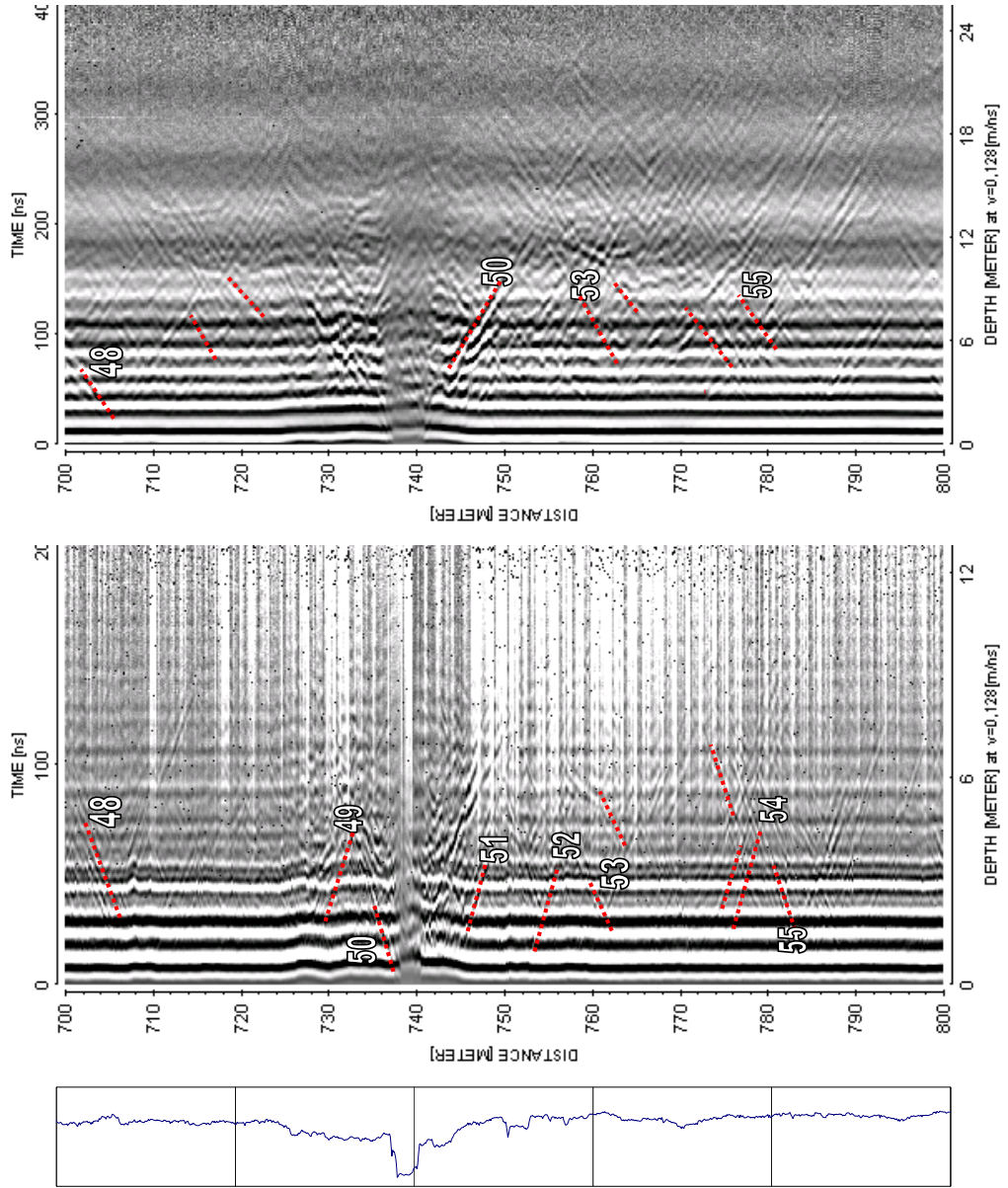

250 MHz

100 MHz

FORSMARK KFM04A with interpretation

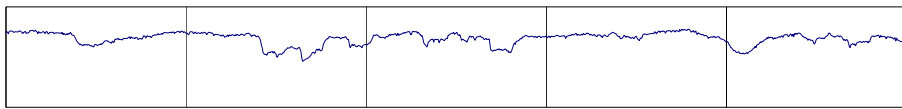
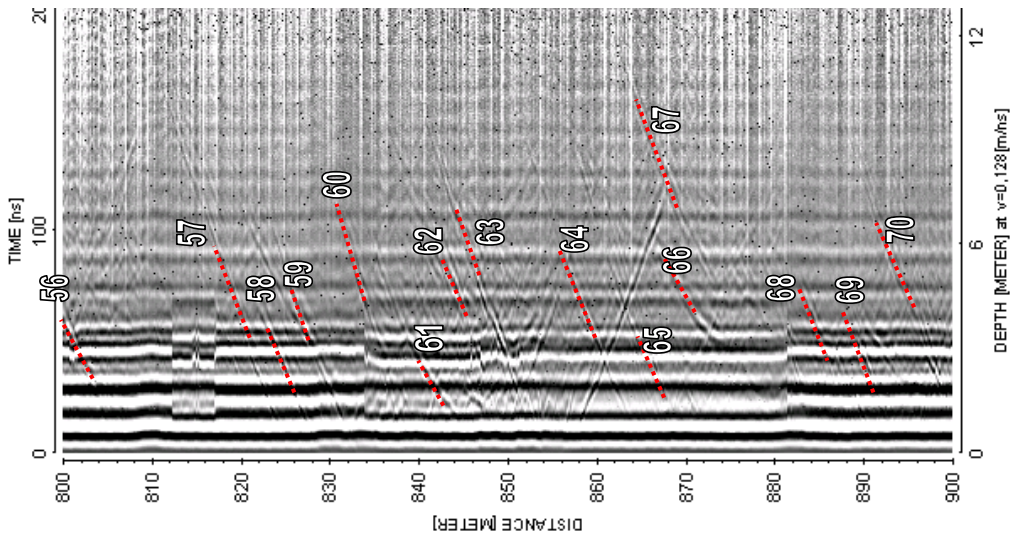
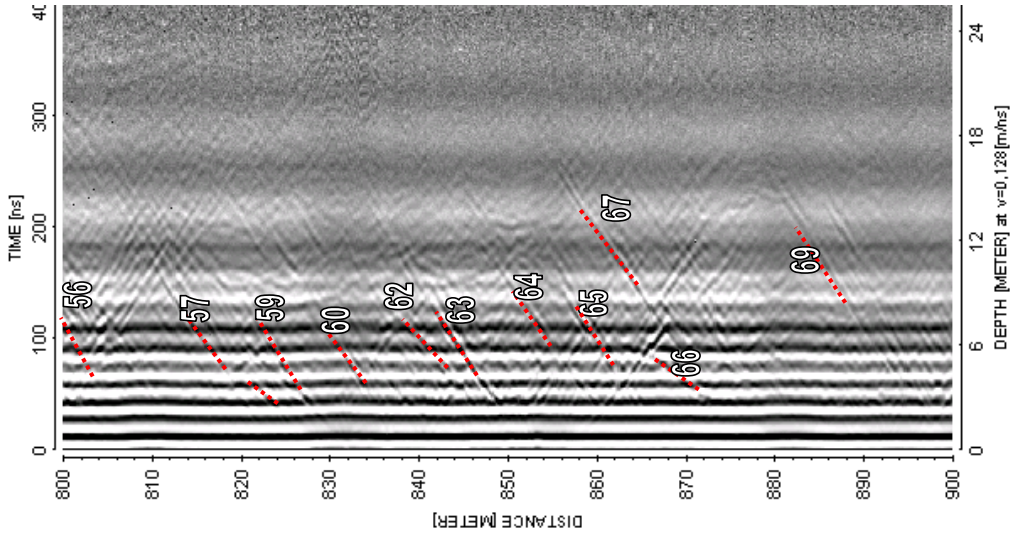

FORSMARK KFM04A with interpretation

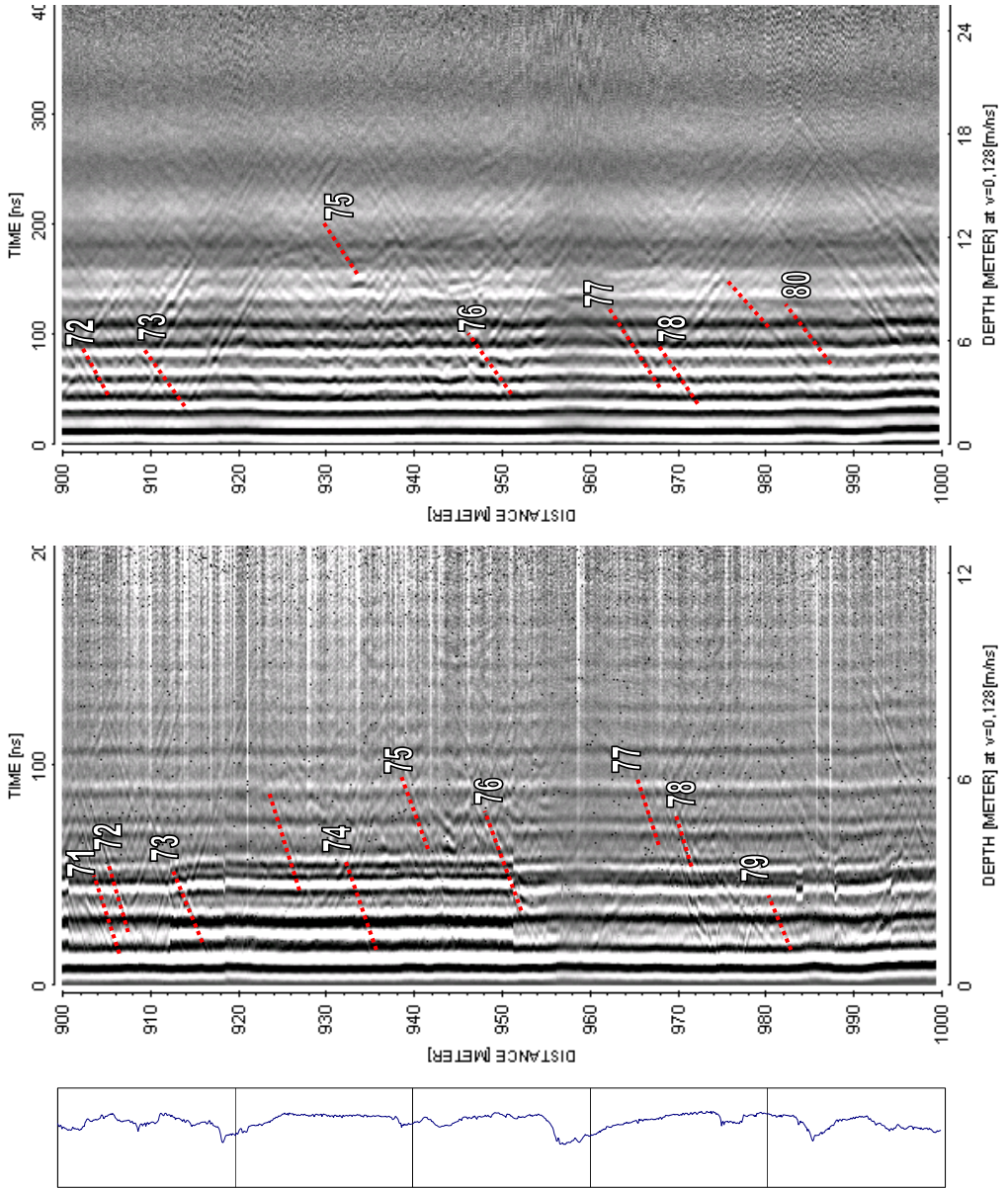

100 MHz

250 MHz

Radar logging of KFM04A, 100 to 1000 m

Dipole antenna 20 MHz

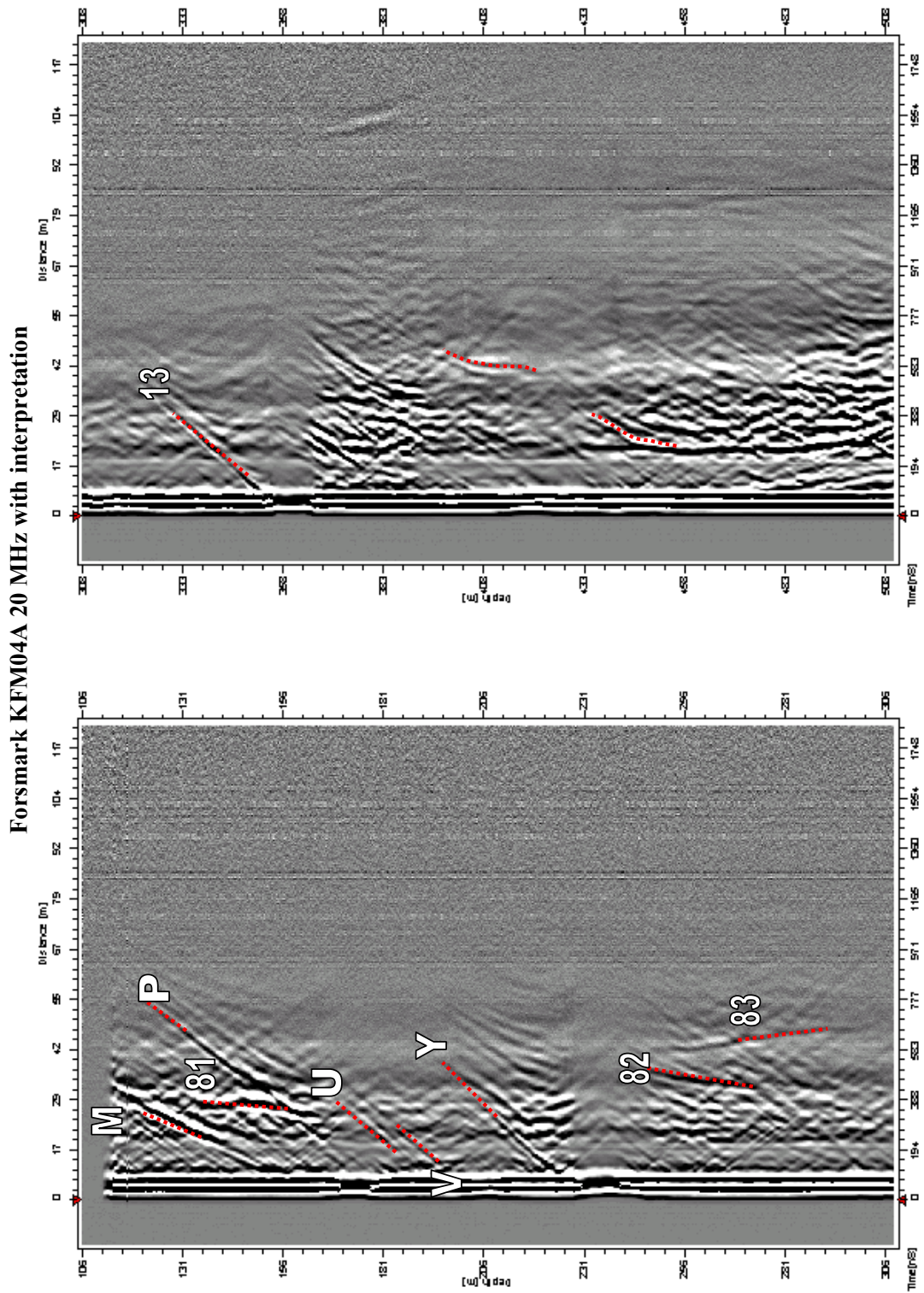

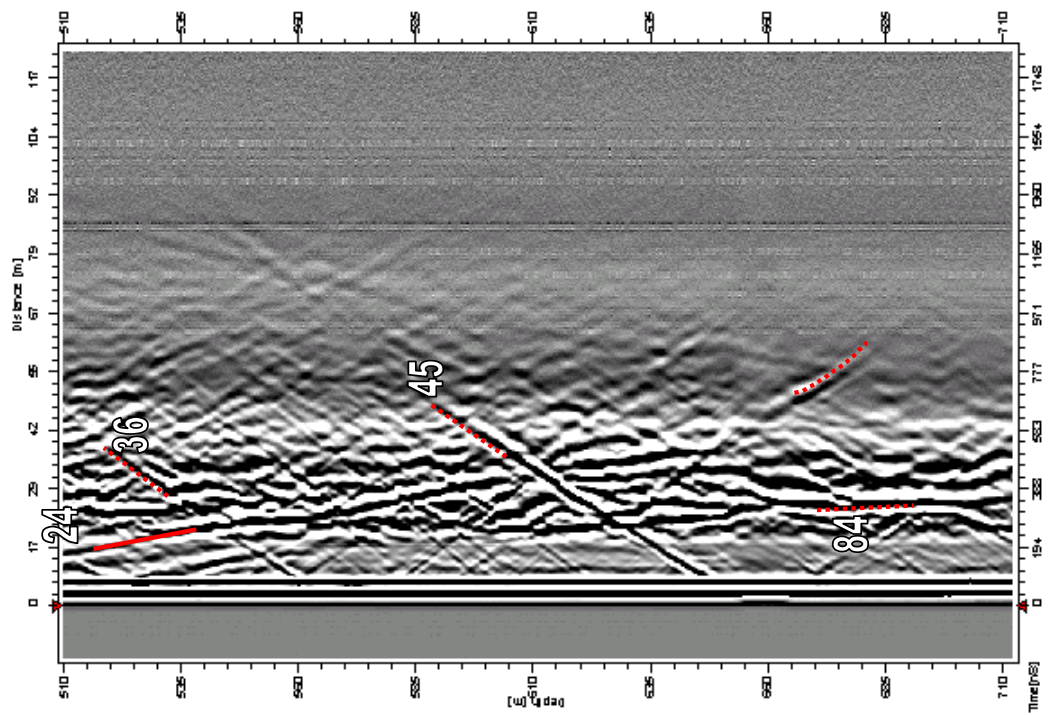
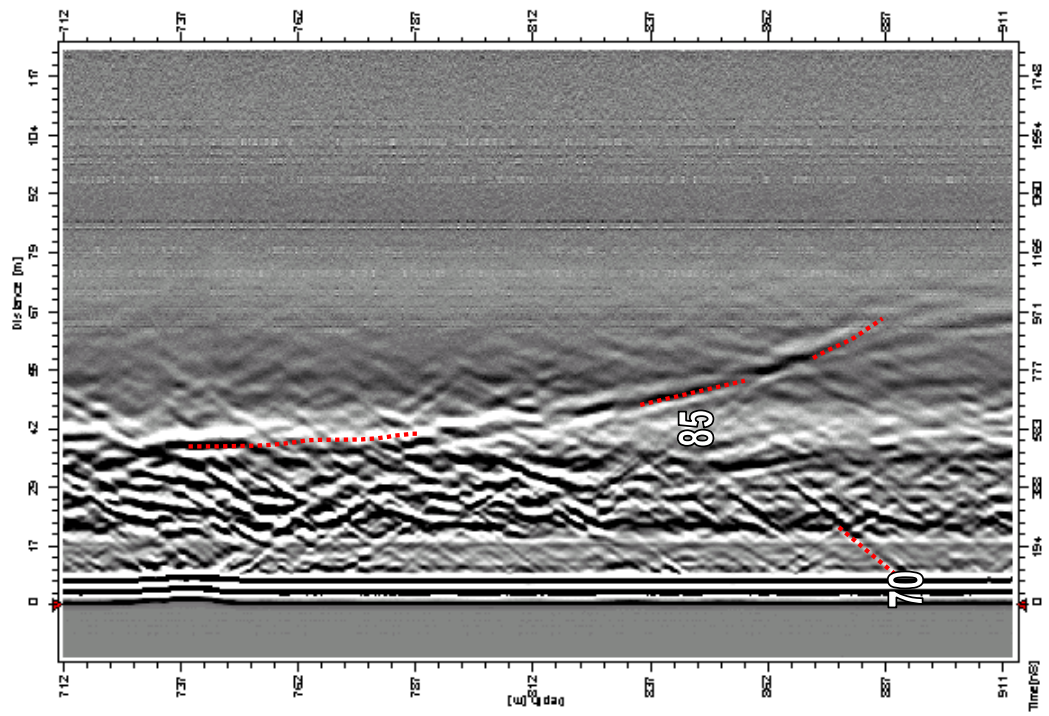

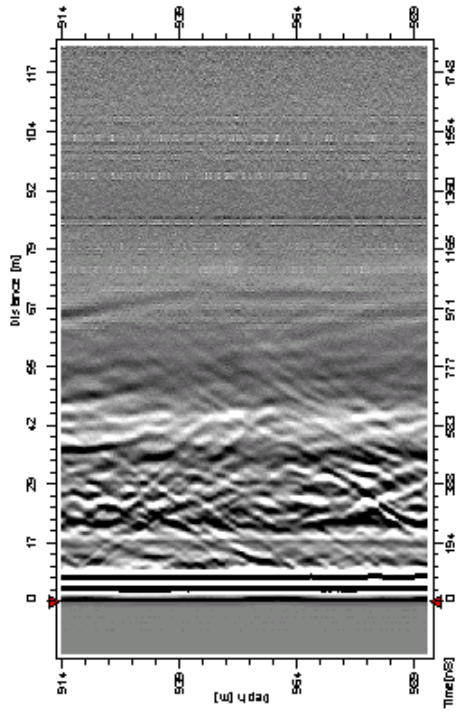

Radar logging of KFM04B, 0 to 100 m

Dipole antennas 250, 100 and 20 MHz

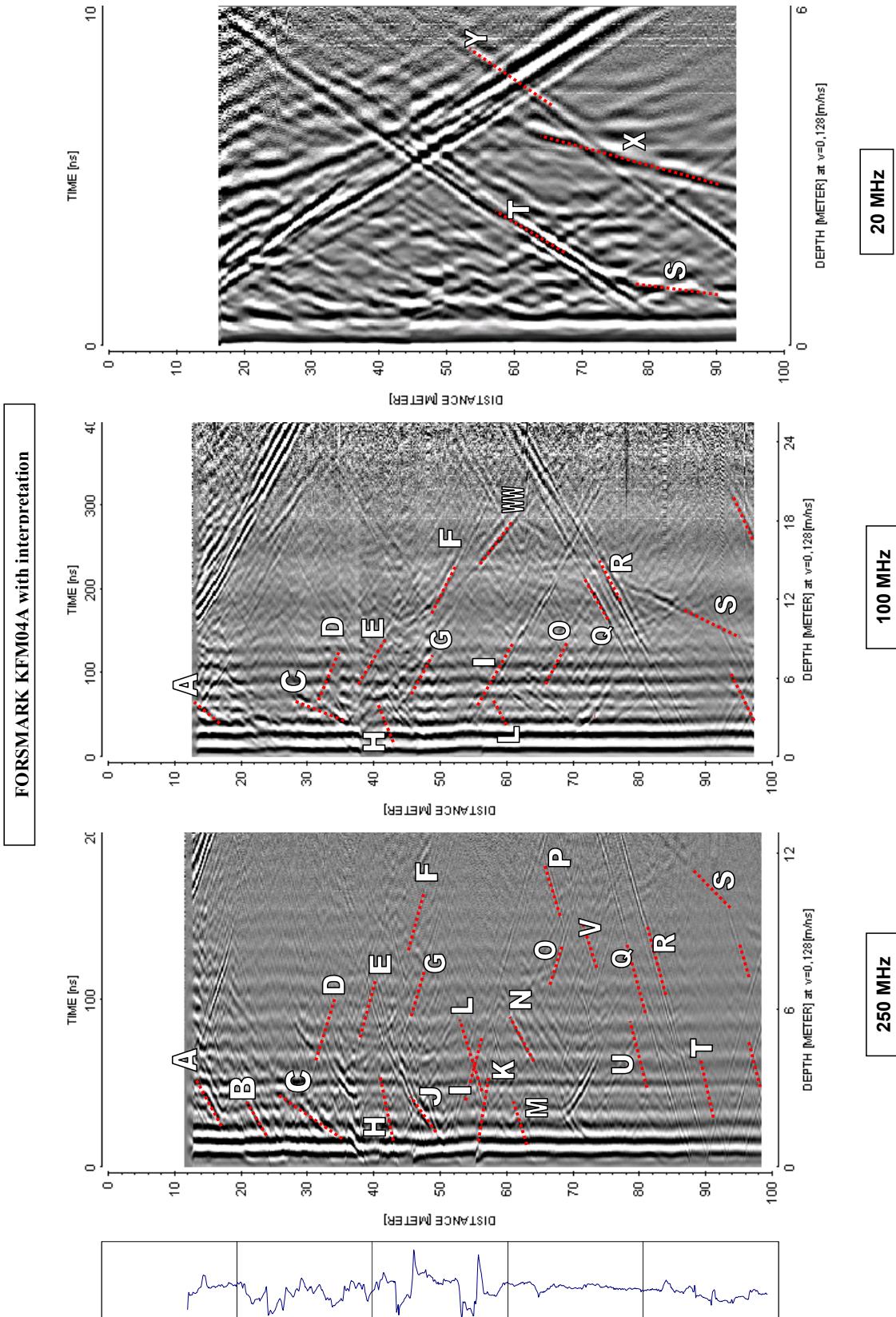

Radar logging of HFM09, 0 to 50 m
Dipole antennas 250 and 100 MHz

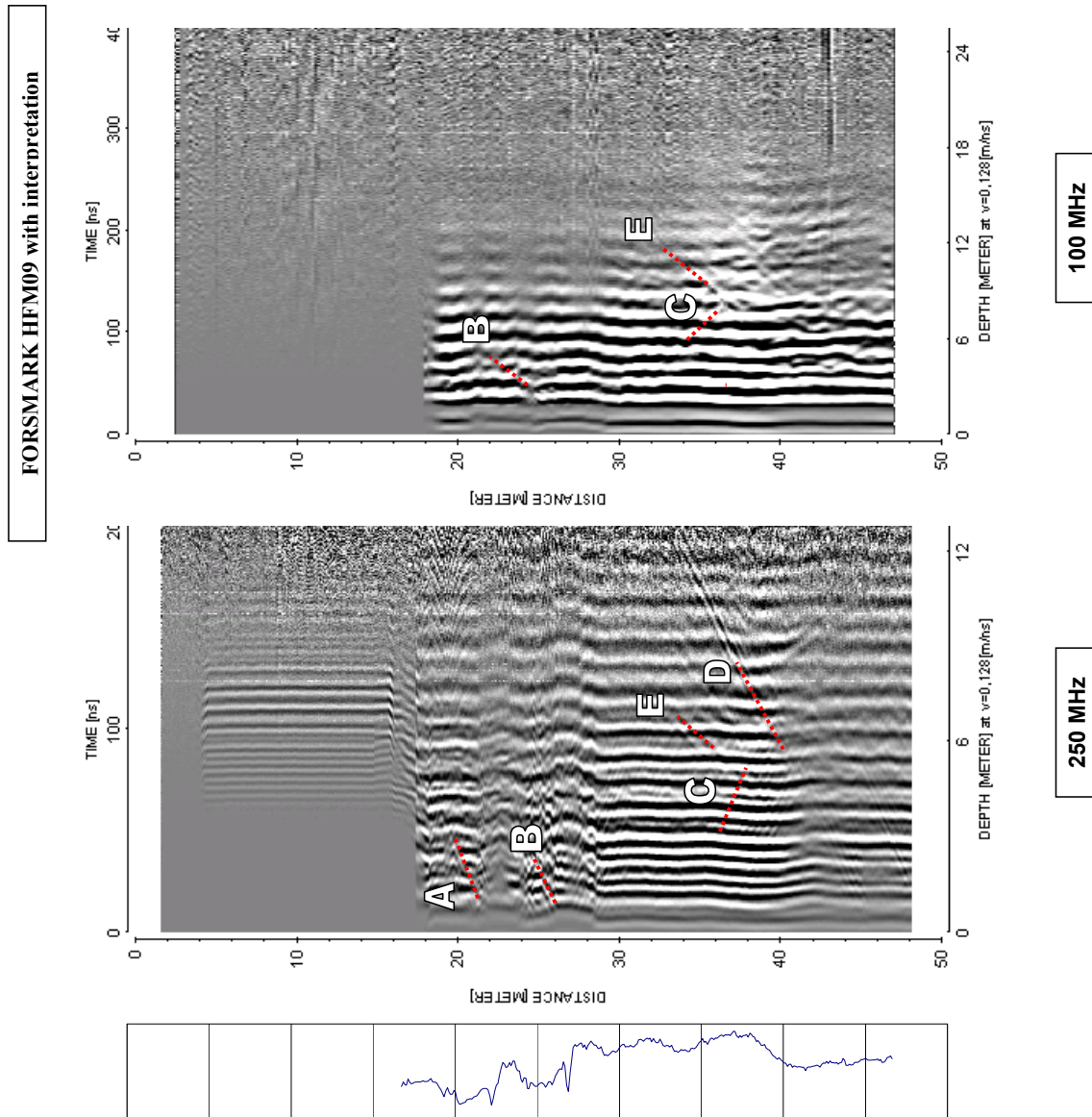

Radar logging of HFM10, 0 to 150 m
Dipole antennas 250, 100 and 20 MHz

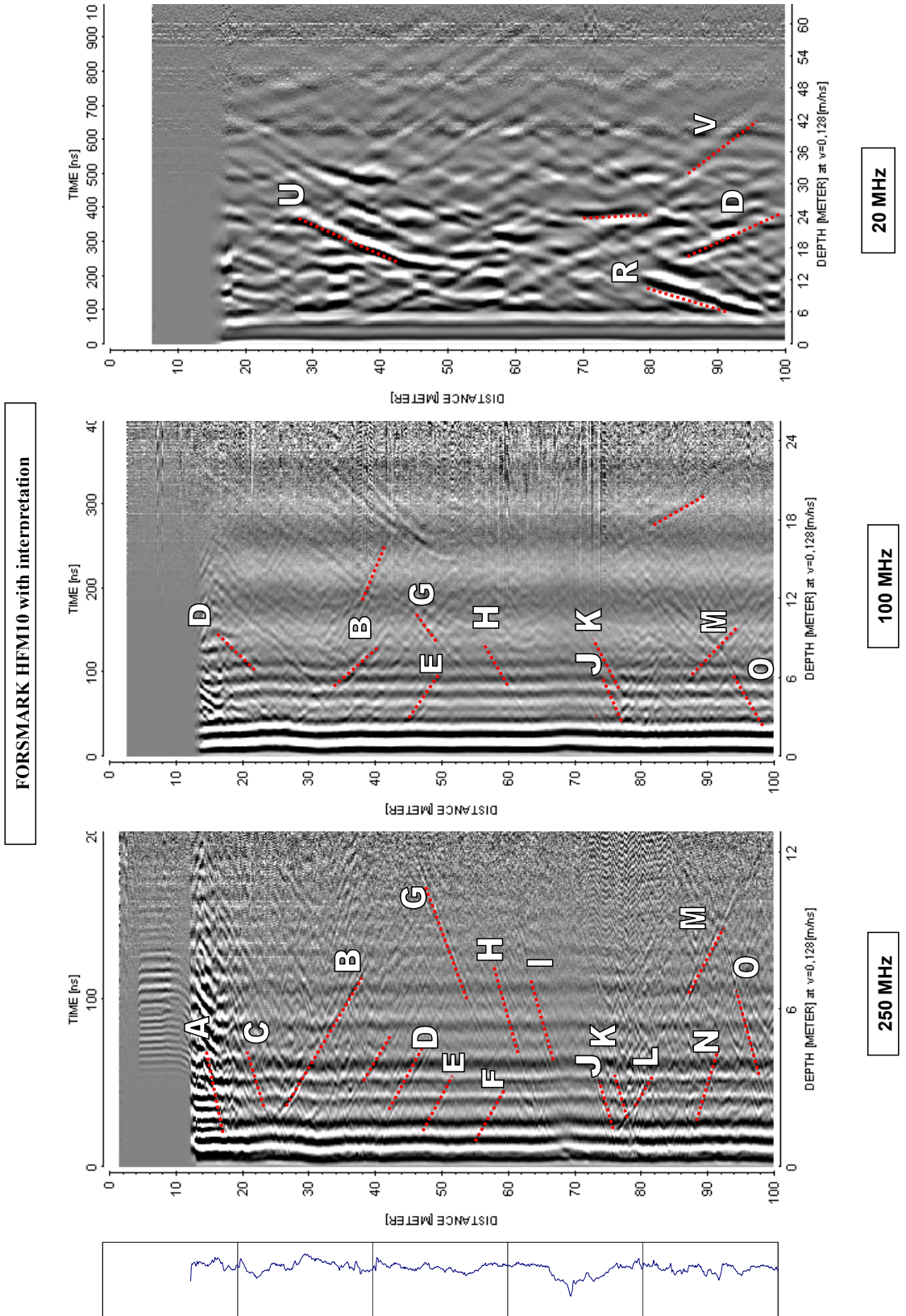

FORSMARK HFM10 with interpretation

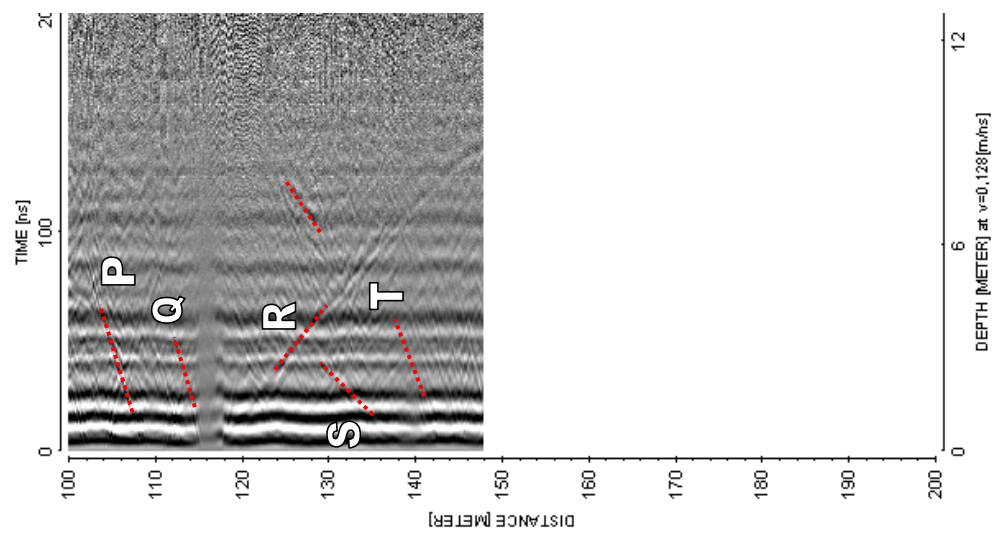
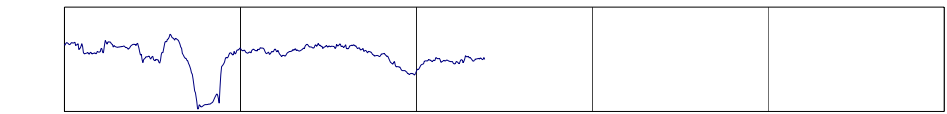

250 MHz

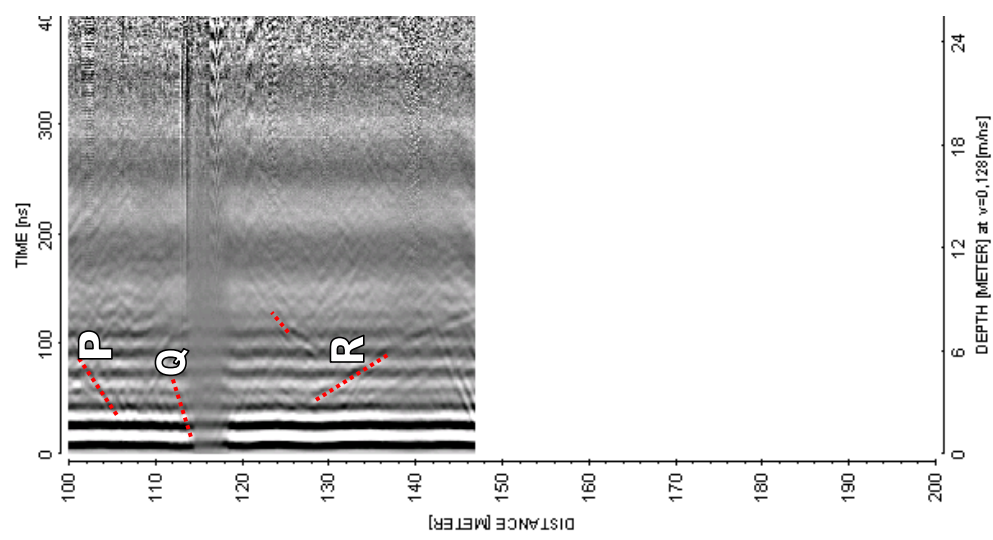

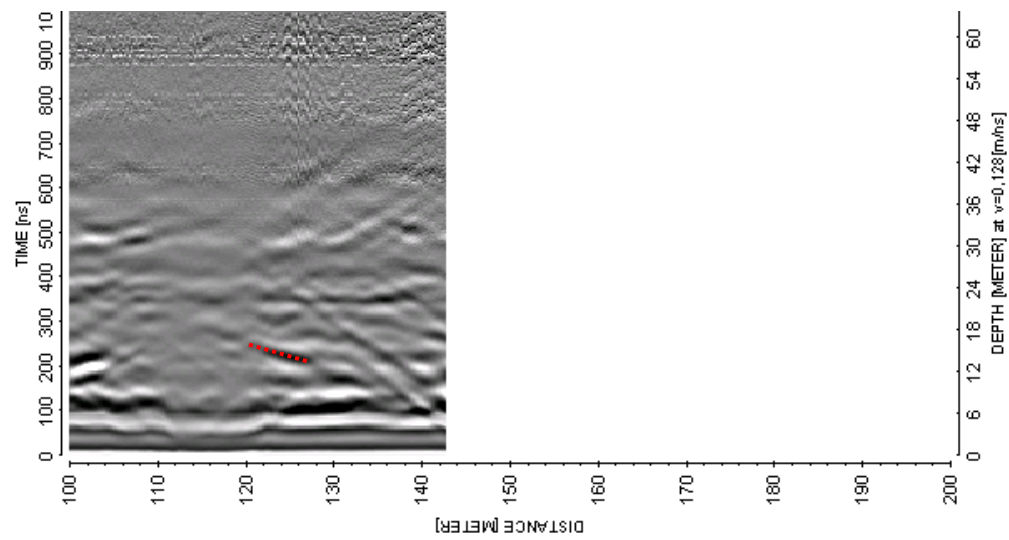

100 MHz



20 MHz

BIPS logging of KFM04A, 11 to 106.8 m

Project name: Forsmark

Image file : h:\work\kfm04a\bips\kfm04a~1.bip
BDT file : h:\work\kfm04a\bips\kfm04a~1.bdt
Locality : FORSMARK
Bore hole number : KFM04A
Date : 03/06/02
Time : 18:41:00
Depth range : 11.000 - 106.759 m (red figures = corrected values)
Azimuth : 0
Inclination : -60
Diameter : 165.0 mm
Magnetic declination : 0.0
Span : 4
Scan interval : 0.25
Scan direction : To bottom
Scale : 1/25
Aspect ratio : 85 %
Pages : 3
Color :  +0  +0  +0

Project name: Forsmark
Bore hole No.: KFM04A

Azimuth: 0

Inclination: -60

Depth range: 11.000 - 31.000 m

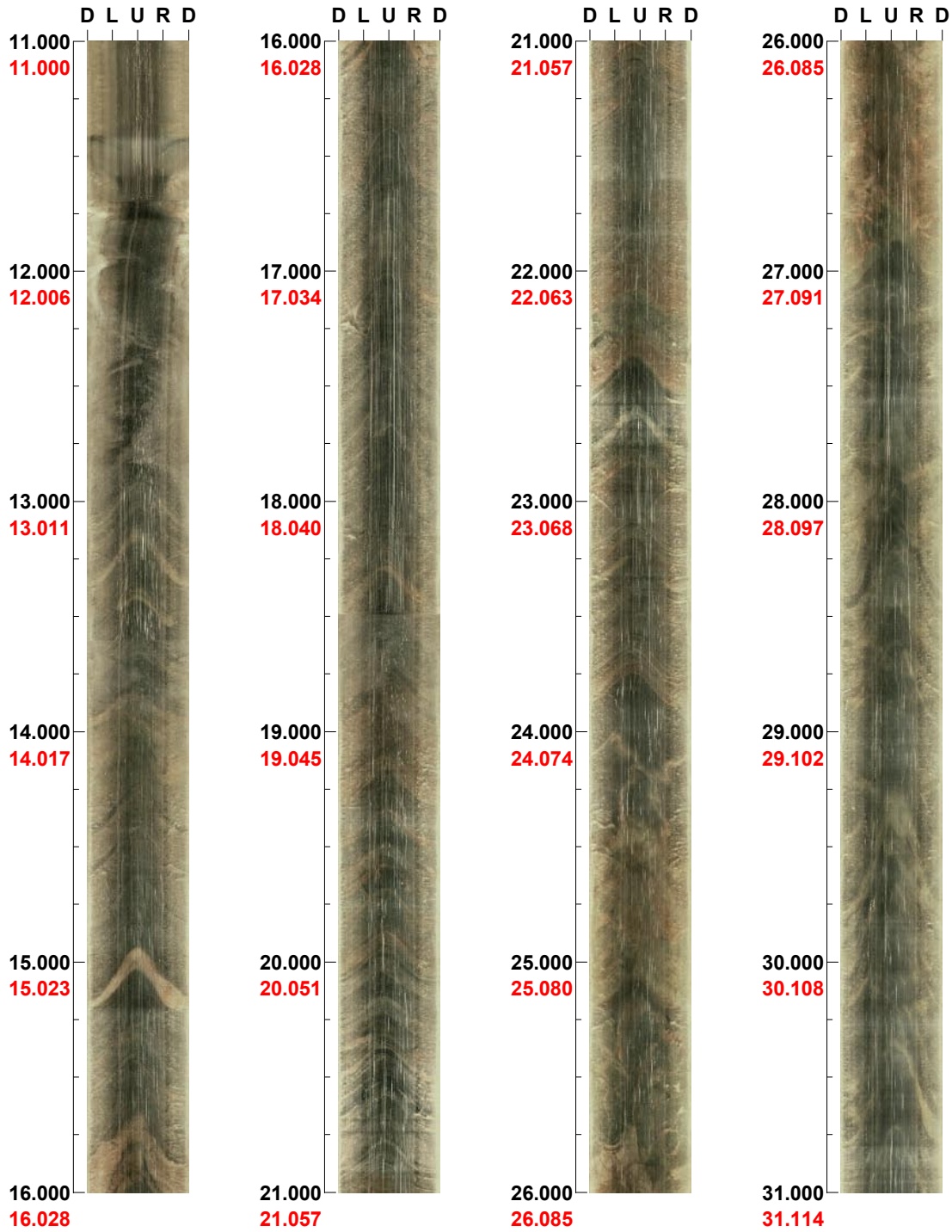

(1 / 3) Scale: 1/25 Aspect ratio: 85 %

Project name: Forsmark
Bore hole No.: KFM04A

Azimuth: 0

Inclination: -60

Depth range: 31.000 - 51.000 m



(2 / 3)

Scale: 1/25

Aspect ratio: 85 %

Project name: Forsmark
Bore hole No.: KFM04A

Azimuth: 0

Inclination: -60

Depth range: 51.000 - 63.843 m

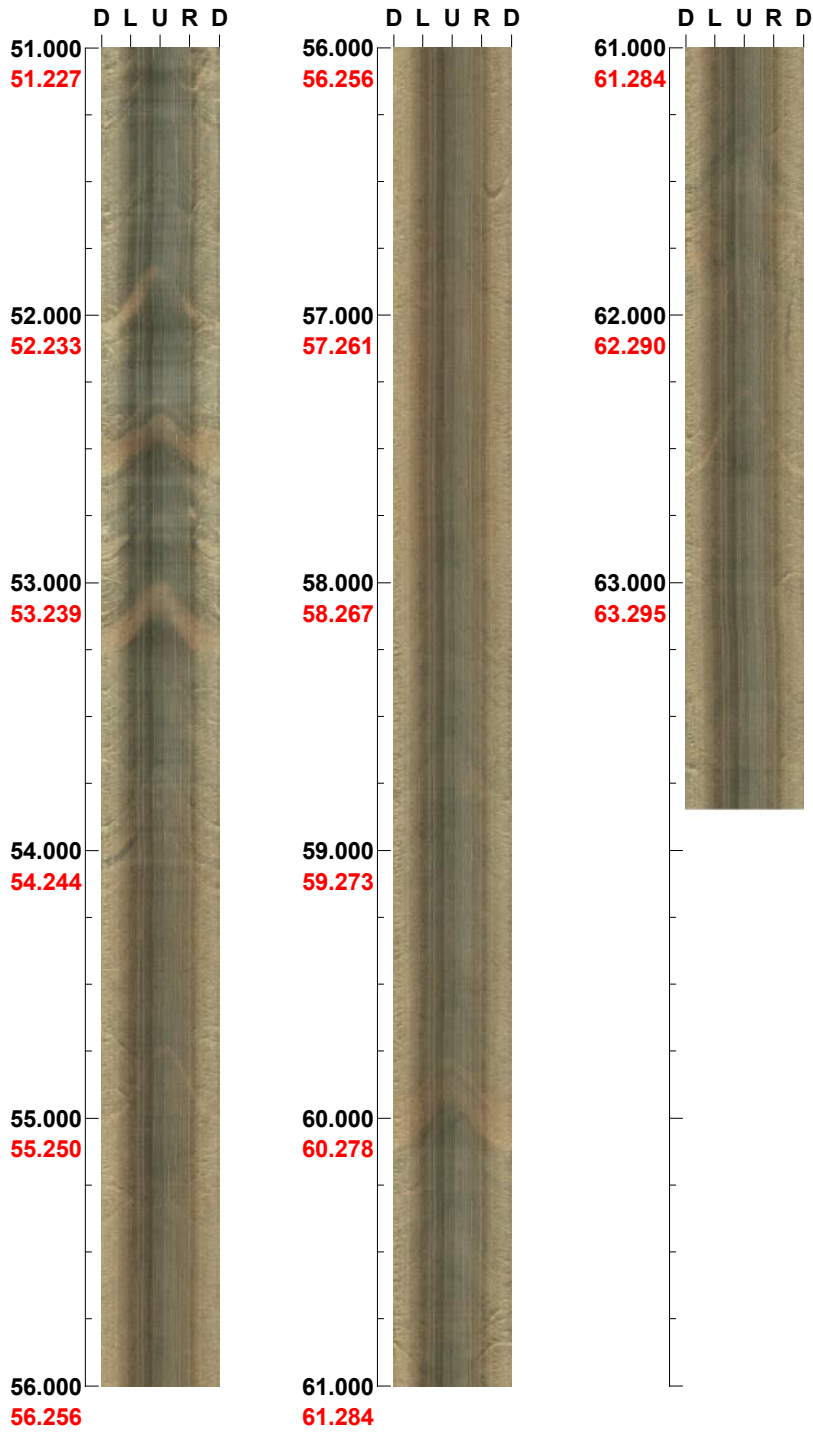

(3 / 3) Scale: 1/25 Aspect ratio: 85 %

Project name: Forsmark
Bore hole No.: KFM04A

Azimuth: 45

Inclination: -60

Depth range: 63.000 - 83.000 m

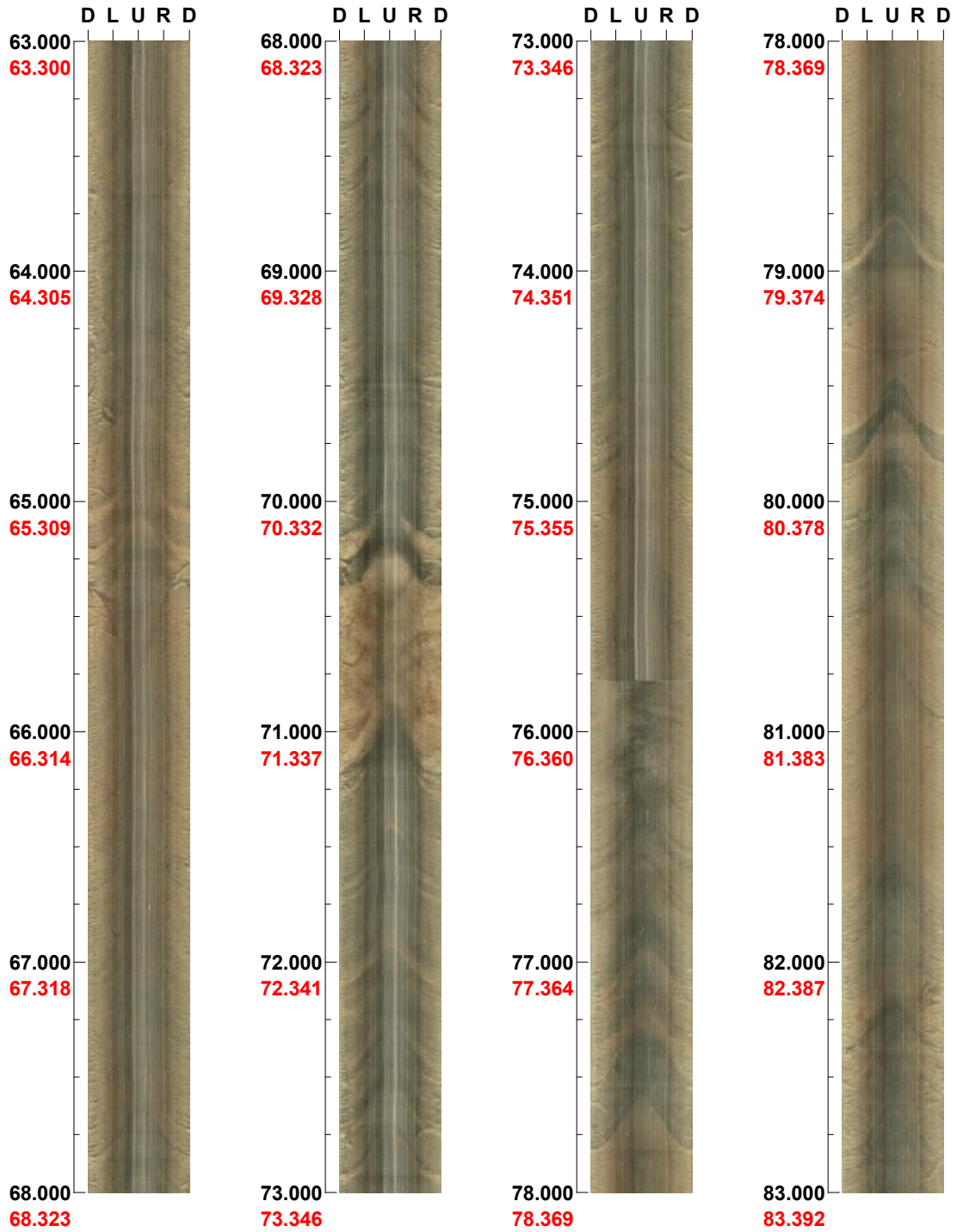

(1 / 3) Scale: 1/25 Aspect ratio: 85 %

Project name: Forsmark
Bore hole No.: KFM04A

Azimuth: 45

Inclination: -60

Depth range: 83.000 - 103.000 m

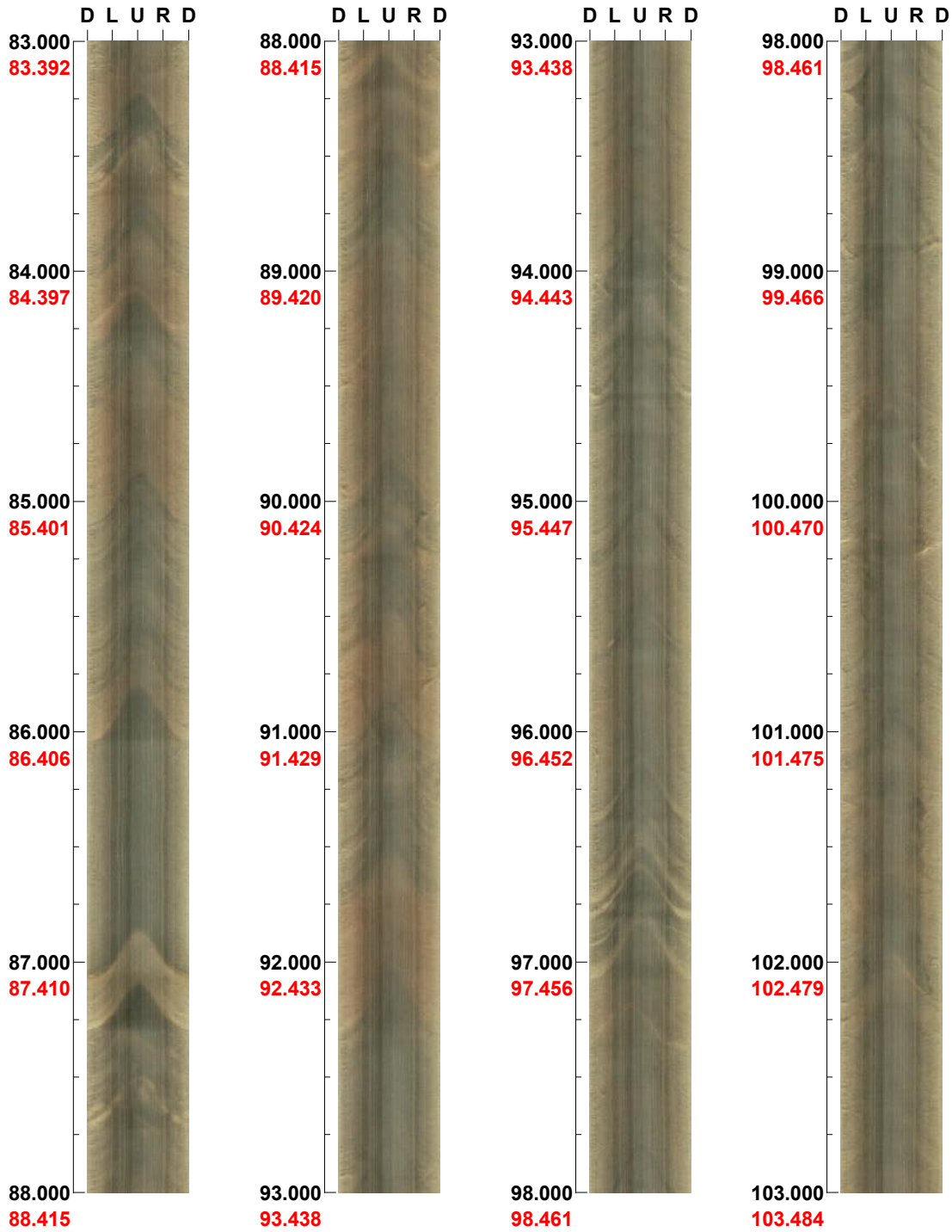

(2 / 3)

Scale: 1/25

Aspect ratio: 85 %

Project name: Forsmark
Bore hole No.: KFM04A

Azimuth: 45

Inclination: -60

Depth range: 103.000 - 106.759 m

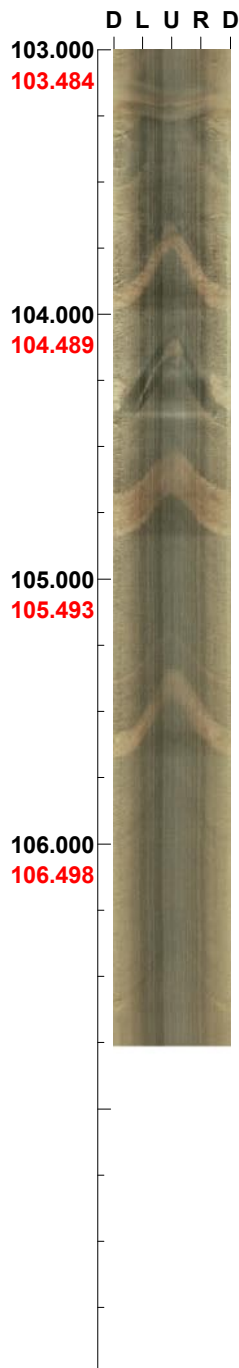



(3 / 3)

Scale: 1/25

Aspect ratio: 85 %

BIPS logging of KFM04A, 108 to 997.6 m

Project name: Forsmark

Image file : c:\work\kfm04a\kfm04a1.bip
BDT file : c:\work\kfm04a\kfm04a1.bdt
Locality : FORSMARK
Bore hole number : KFM04A
Date : 04/03/08
Time : 16:51:00
Depth range : 108.000 - 997.75 m (red figures = corrected values)
Azimuth : 45
Inclination : -60
Diameter : 76.0 mm
Magnetic declination : 0.0
Span : 4
Scan interval : 0.25
Scan direction : To bottom
Scale : 1/25
Aspect ratio : 175 %
Pages : 10
Color :  +0  +0  +0

Project name: Forsmark
Bore hole No.: KFM04A

Azimuth: 45

Inclination: -60

Depth range: 128.000 - 148.000 m

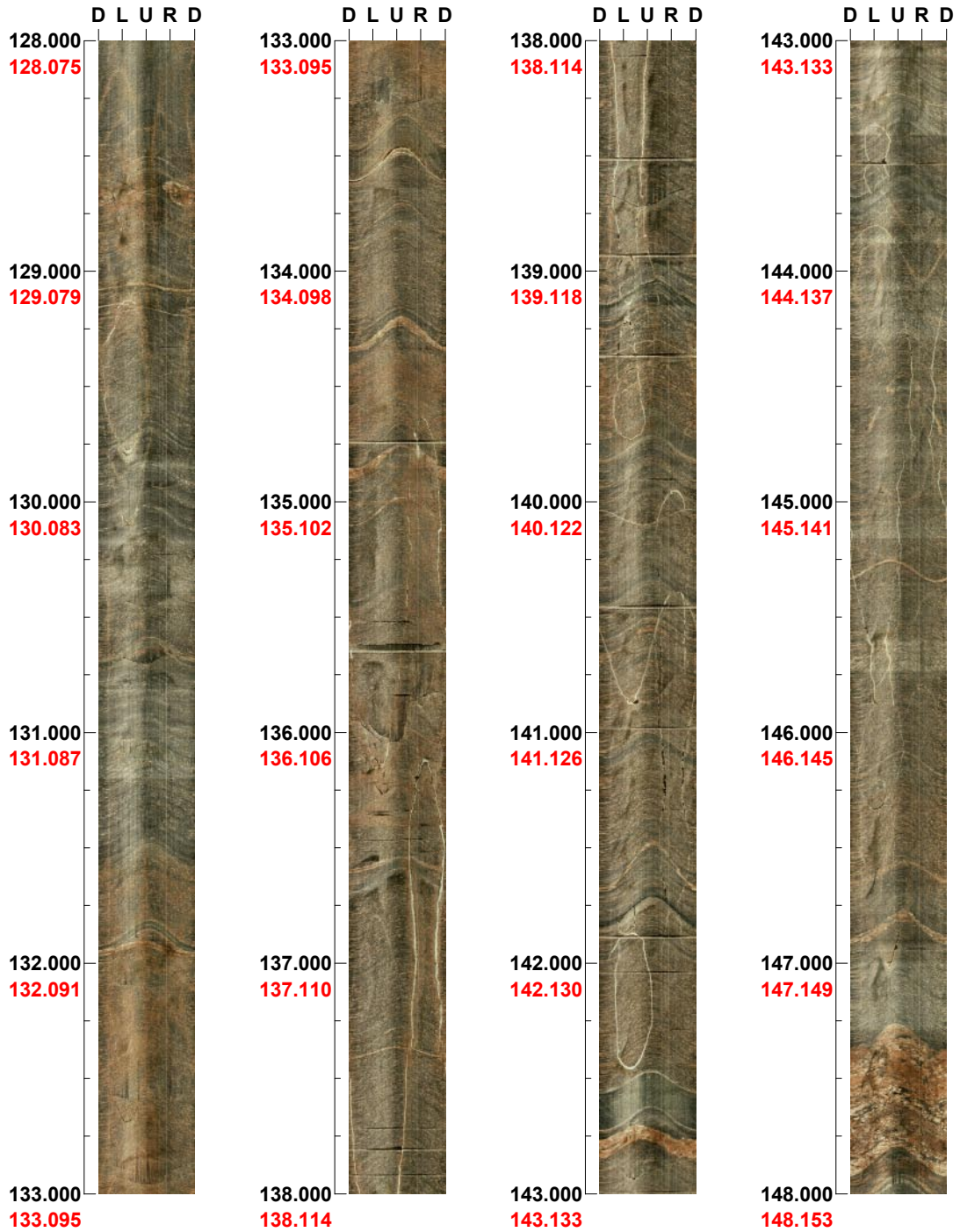

(2 / 10)

Scale: 1/25

Aspect ratio: 175 %

Project name: Forsmark
Bore hole No.: KFM04A

Azimuth: 45

Inclination: -60

Depth range: 148.000 - 168.000 m

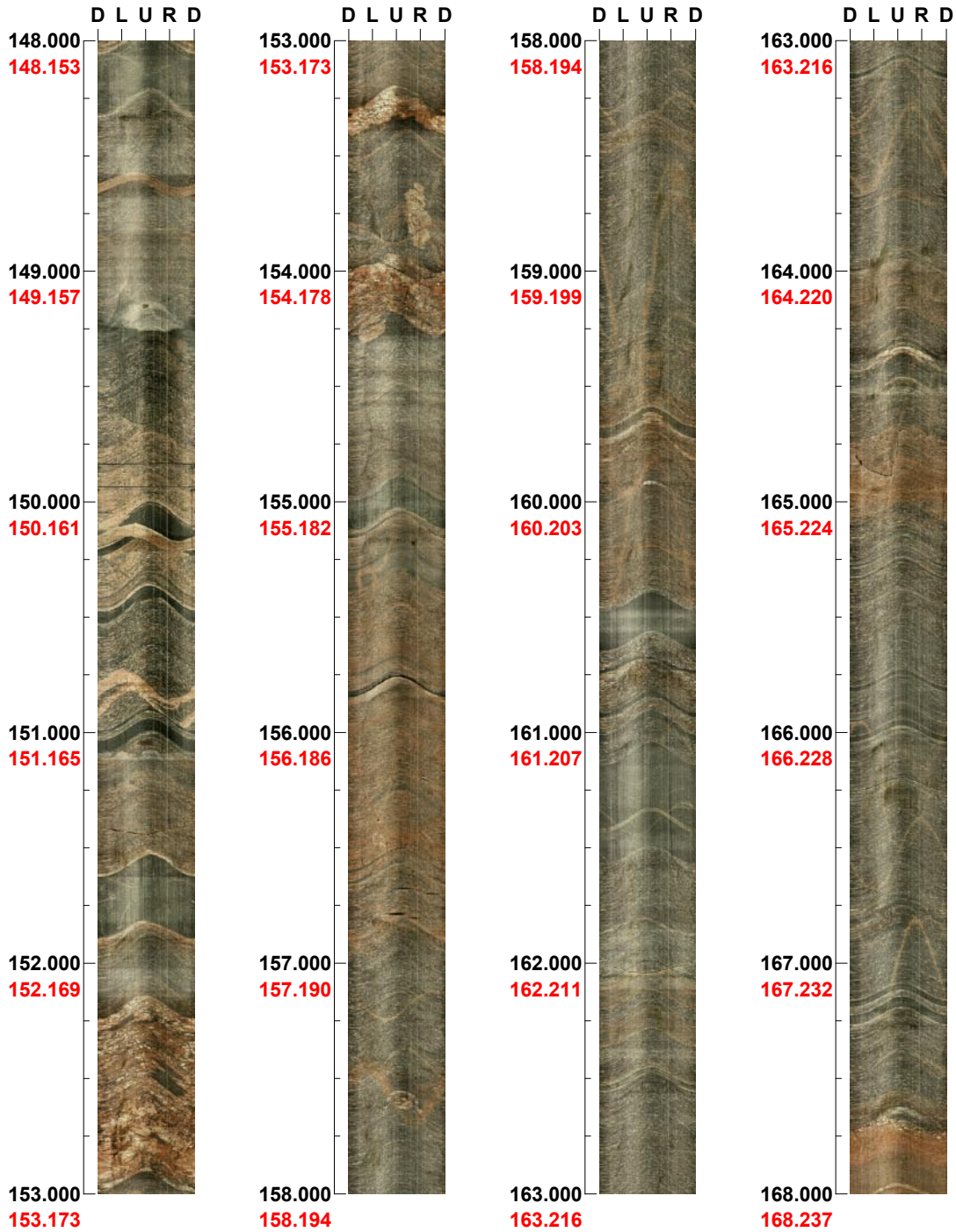

(3 / 10) Scale: 1/25 Aspect ratio: 175 %

Project name: Forsmark
Bore hole No.: KFM04A

Azimuth: 45

Inclination: -60

Depth range: 168.000 - 188.000 m

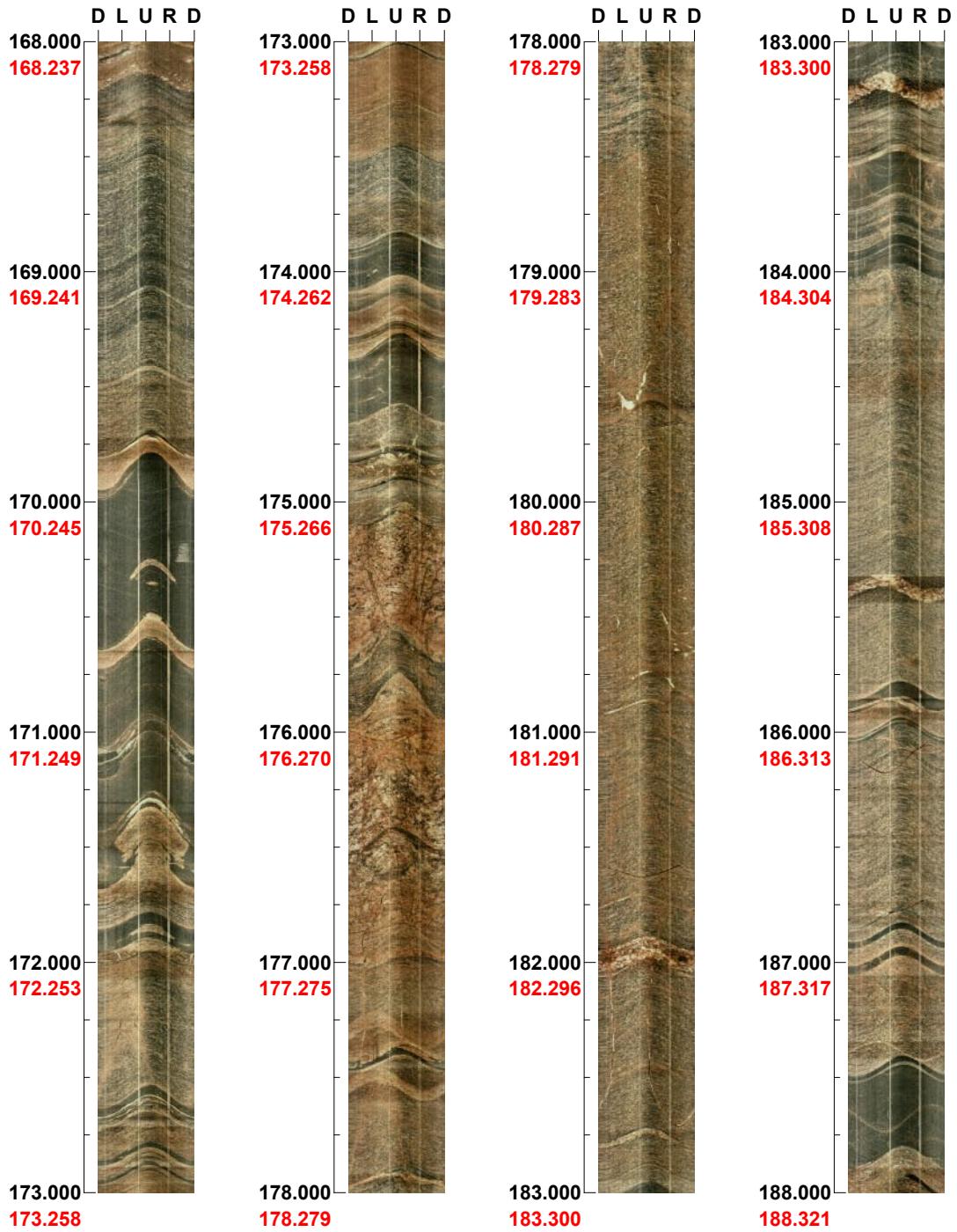

(4 / 10)

Scale: 1/25

Aspect ratio: 175 %

Project name: Forsmark
Bore hole No.: KFM04A

Azimuth: 45 Inclinaton: -60

Depth range: 188.000 - 208.000 m

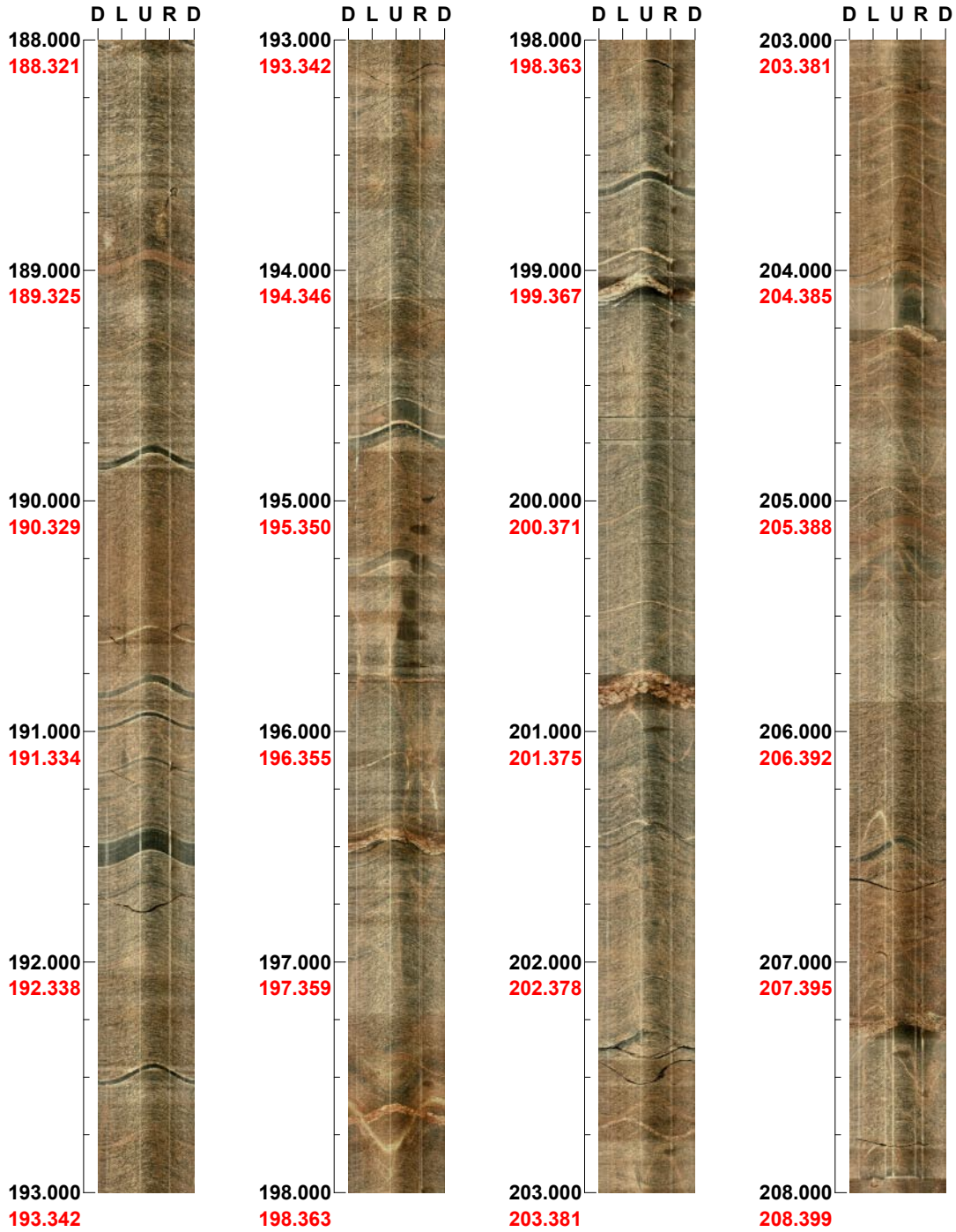

(5 / 10) Scale: 1/25 Aspect ratio: 175 %

Project name: Forsmark
Bore hole No.: KFM04A

Azimuth: 45

Inclination: -60

Depth range: 208.000 - 228.000 m



(6 / 10)

Scale: 1/25

Aspect ratio: 175 %

Project name: Forsmark
Bore hole No.: KFM04A

Azimuth: 45

Inclination: -60

Depth range: 228.000 - 248.000 m



(7 / 10) Scale: 1/25 Aspect ratio: 175 %

Project name: Forsmark
Bore hole No.: KFM04A

Azimuth: 45

Inclination: -60

Depth range: 248.000 - 268.000 m

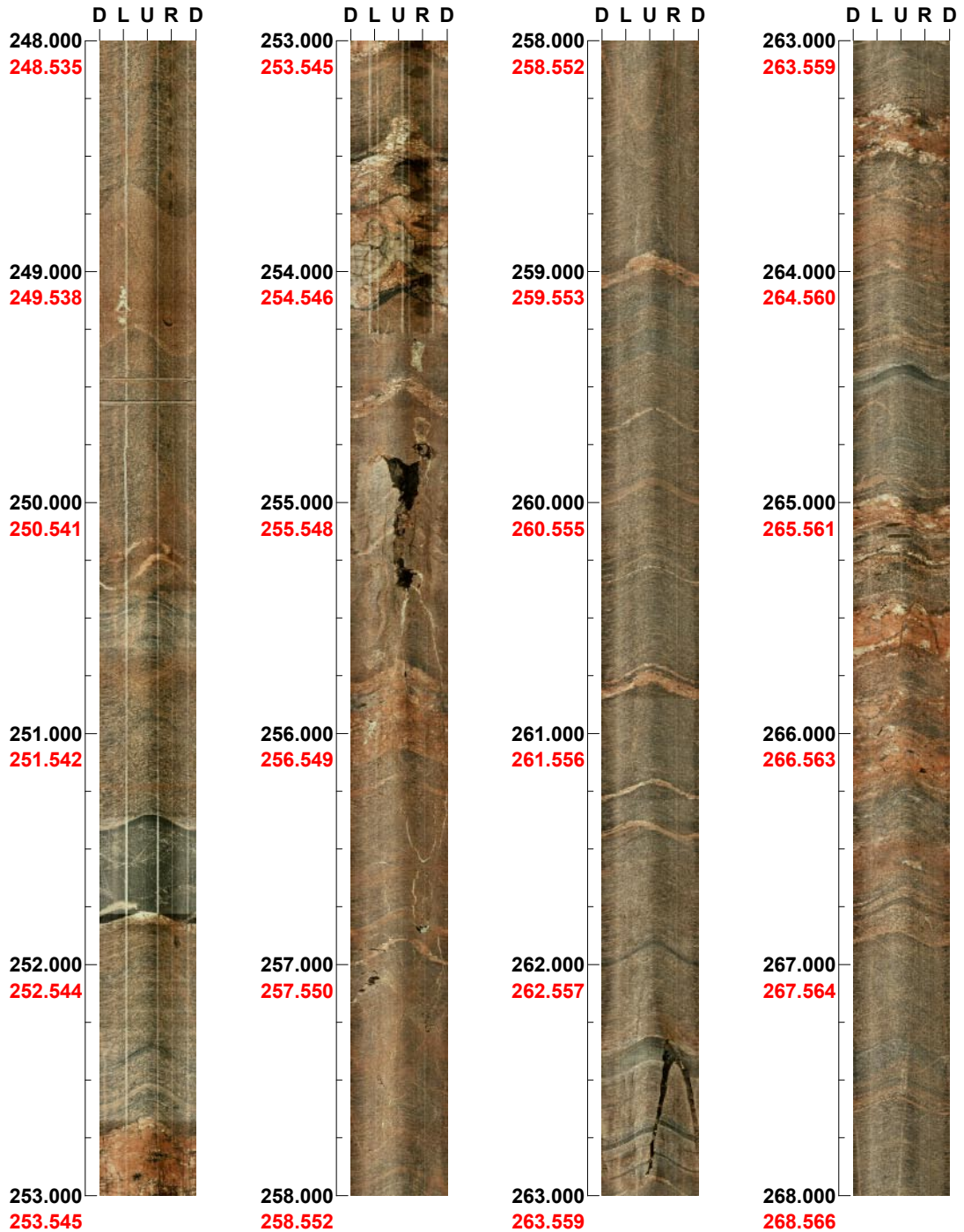

(8 / 10)

Scale: 1/25

Aspect ratio: 175 %

Project name: Forsmark
Bore hole No.: KFM04A

Azimuth: 45

Inclination: -60

Depth range: 268.000 - 288.000 m

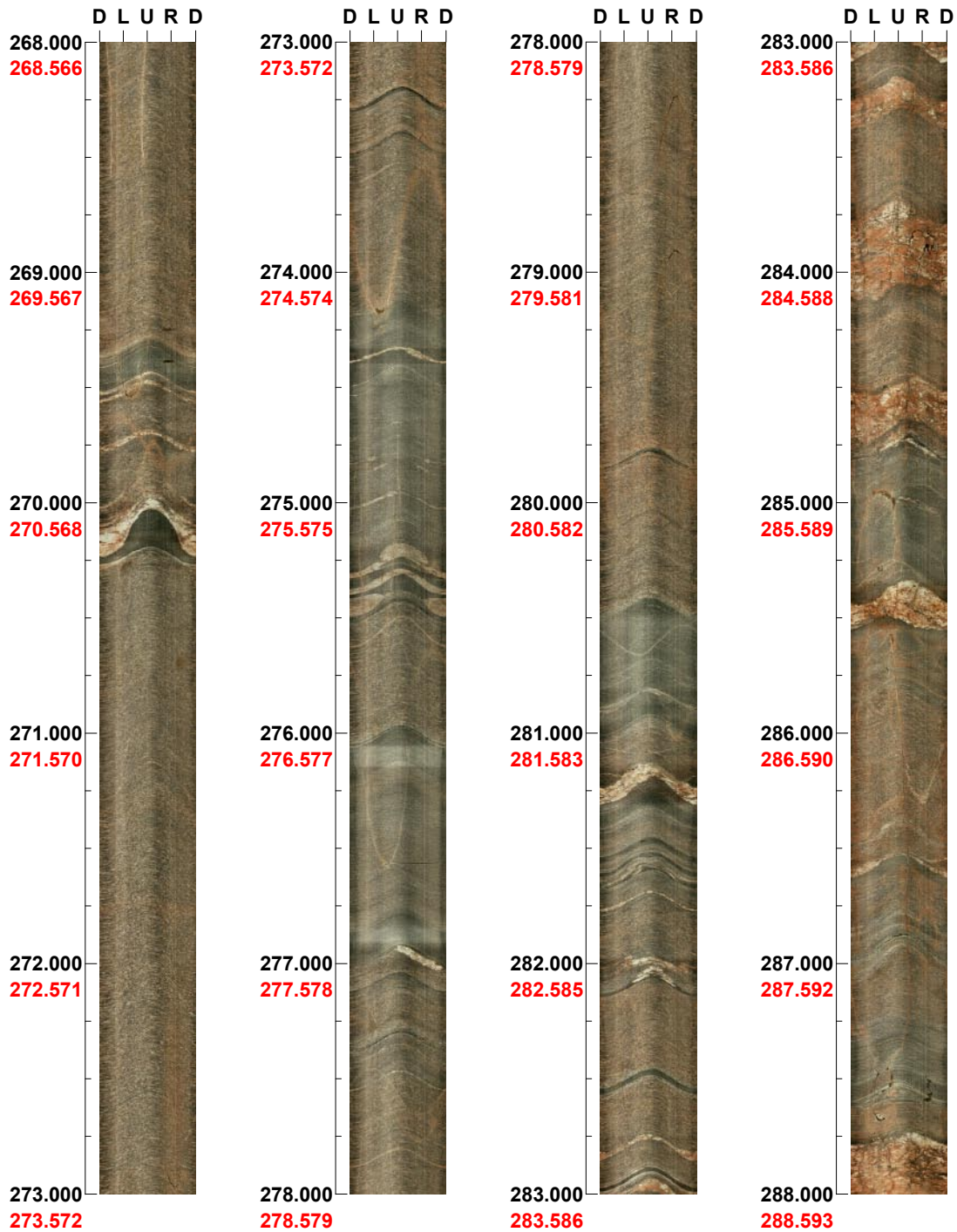

(9 / 10) Scale: 1/25 Aspect ratio: 175 %

Project name: Forsmark
Bore hole No.: KFM04A

Azimuth: 45

Inclination:

Depth range: 288.000 - 294.008 m

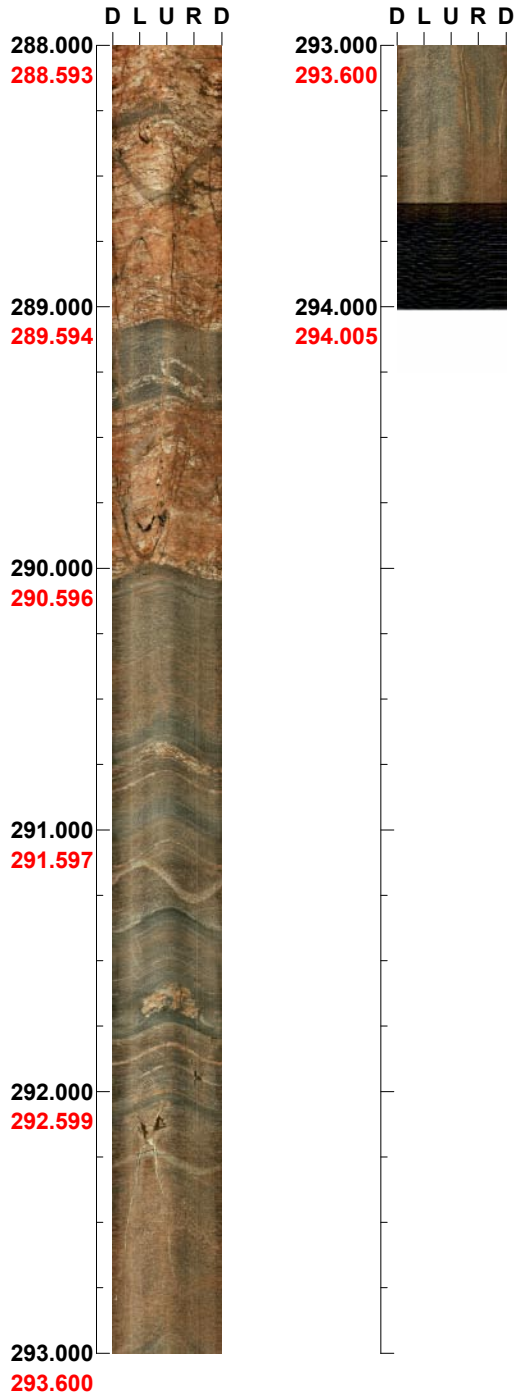

(10 / 10) Scale: 1/25 Aspect ratio: 175 %

Project name: Forsmark
Bore hole No.: KFM04A

Azimuth: 45

Inclination: -60

Depth range: 290.000 - 310.000 m



(1 / 16) Scale: 1/25 Aspect ratio: 175 %

Project name: Forsmark
Bore hole No.: KFM04A

Azimuth: 45

Inclination: -60

Depth range: 310.000 - 330.000 m

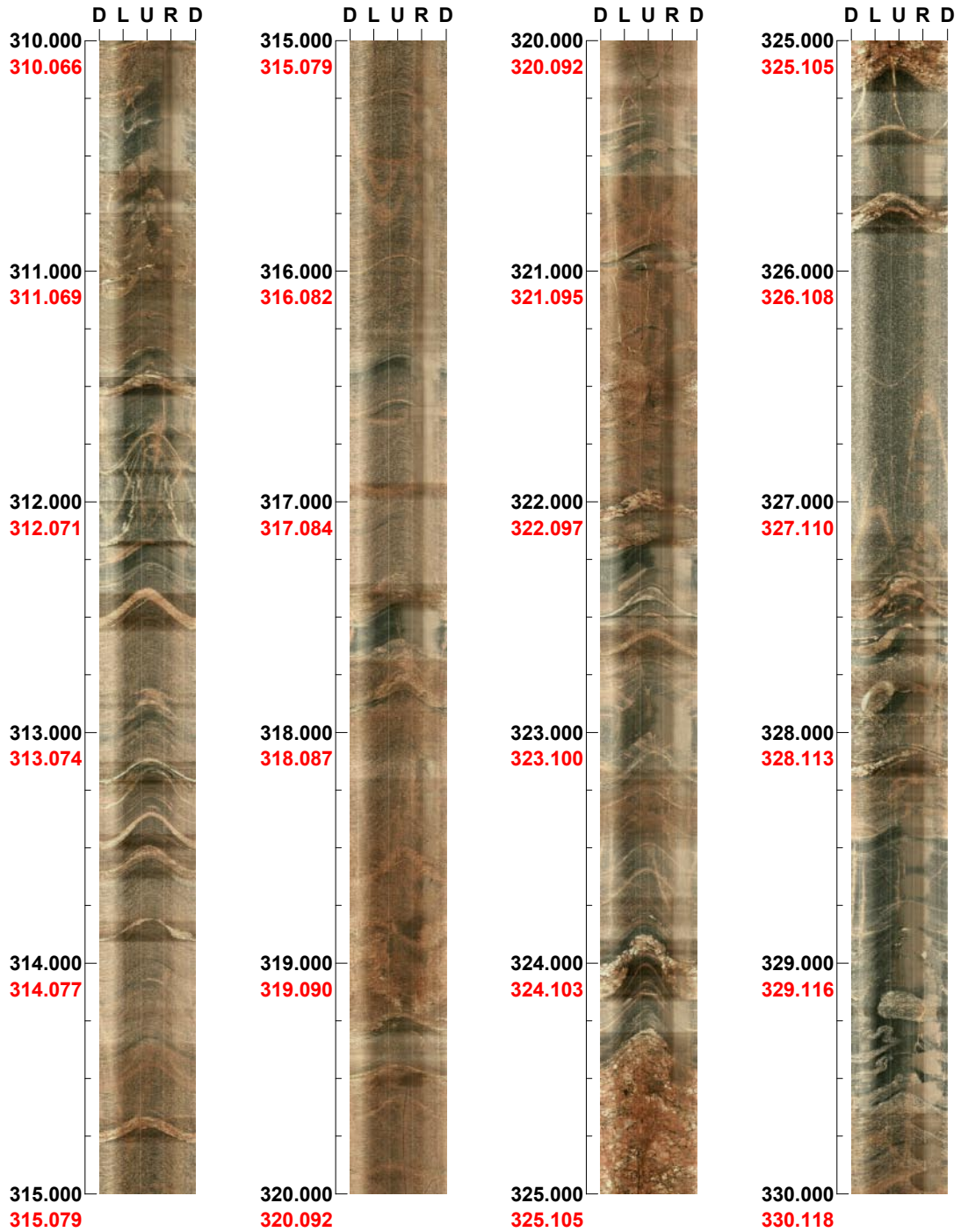

(2 / 16)

Scale: 1/25

Aspect ratio: 175 %

Project name: Forsmark
Bore hole No.: KFM04A

Azimuth: 45

Inclination: -60

Depth range: 330.000 - 350.000 m



(3 / 16) Scale: 1/25 Aspect ratio: 175 %

Project name: Forsmark
Bore hole No.: KFM04A

Azimuth: 45

Inclination: -60

Depth range: 350.000 - 370.000 m

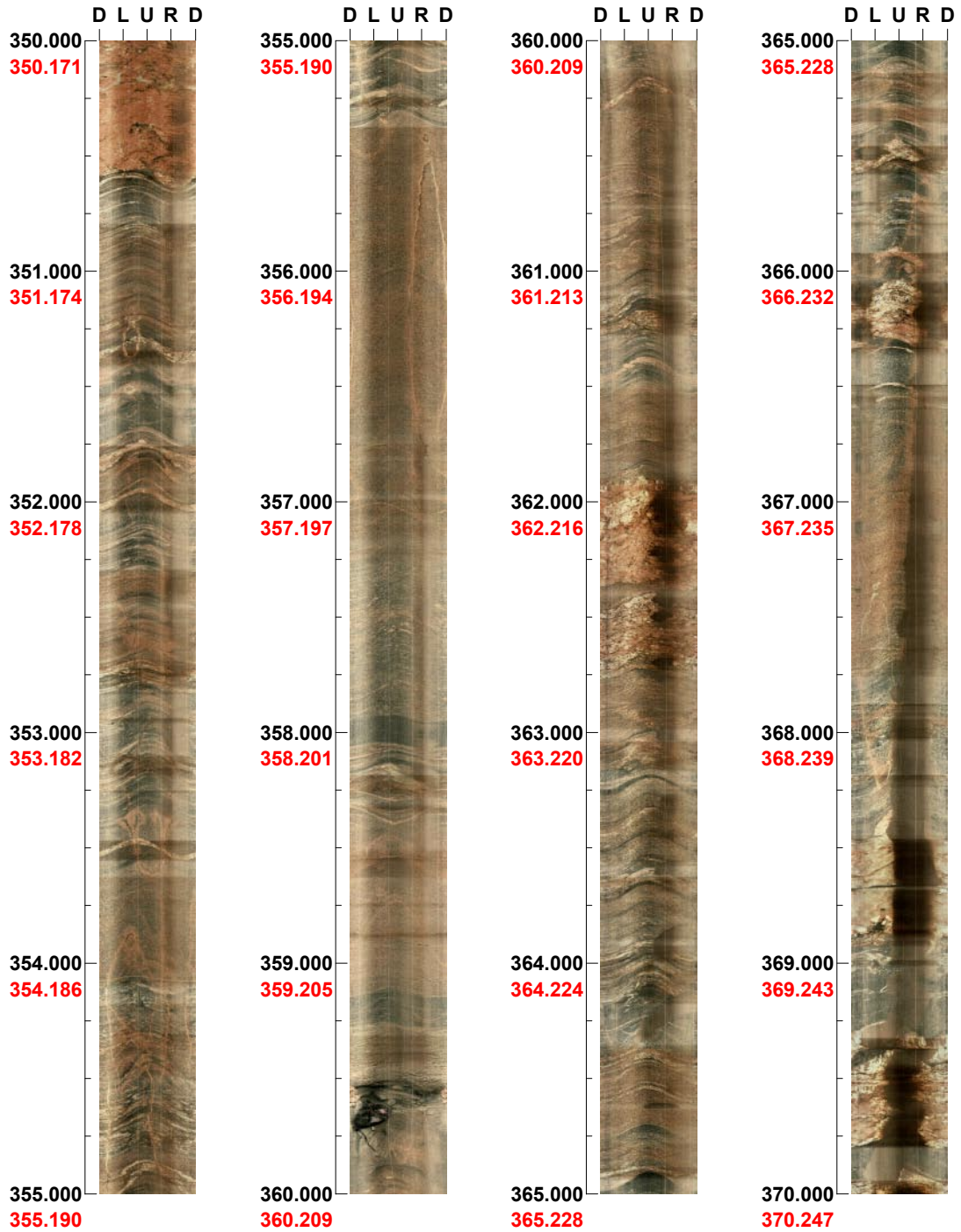

(4 / 16)

Scale: 1/25

Aspect ratio: 175 %

Project name: Forsmark
Bore hole No.: KFM04A

Azimuth: 45

Inclination: -60

Depth range: 370.000 - 390.000 m

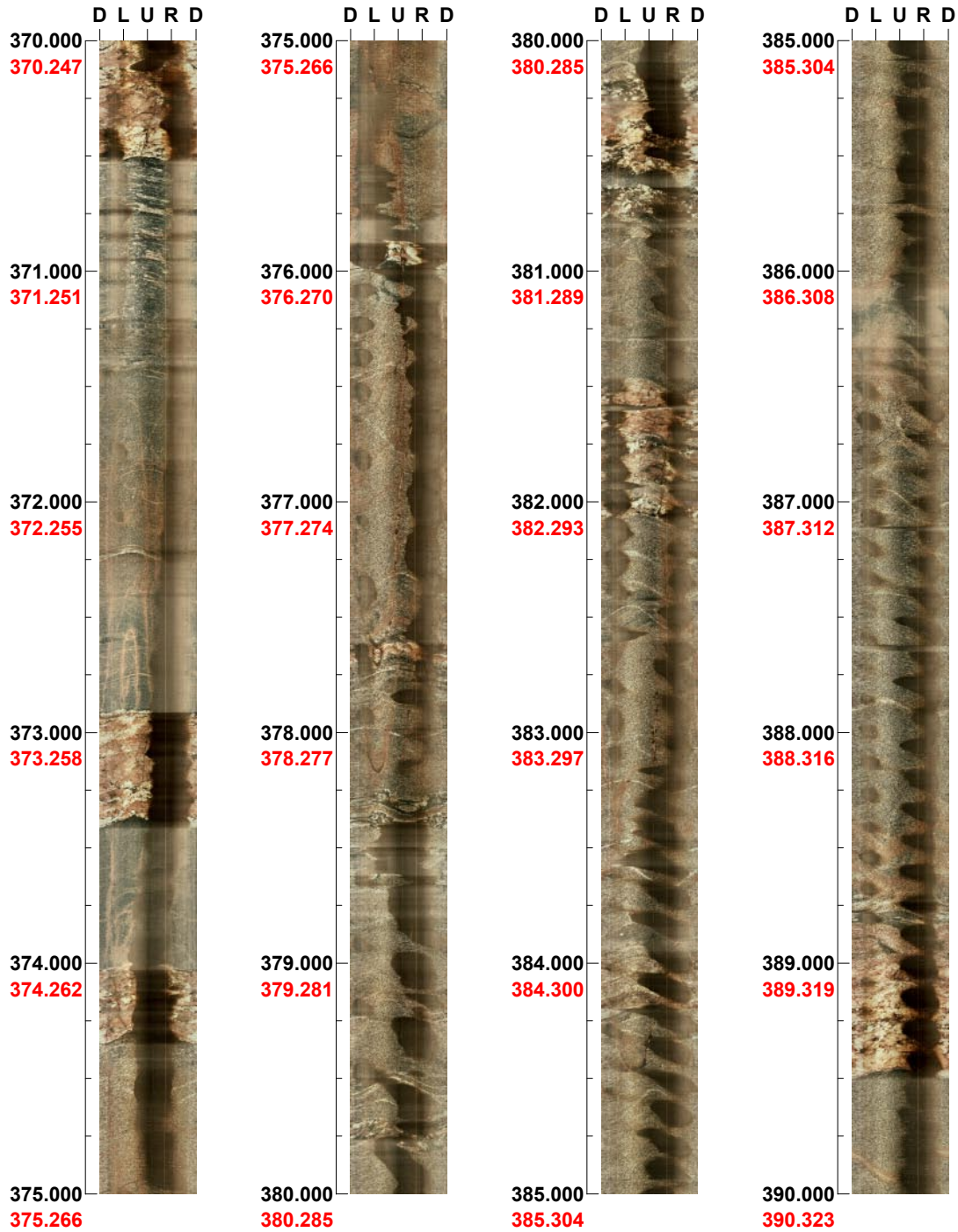

(5 / 16) Scale: 1/25 Aspect ratio: 175 %

Project name: Forsmark
Bore hole No.: KFM04A

Azimuth: 45

Inclination: -60

Depth range: 390.000 - 410.000 m

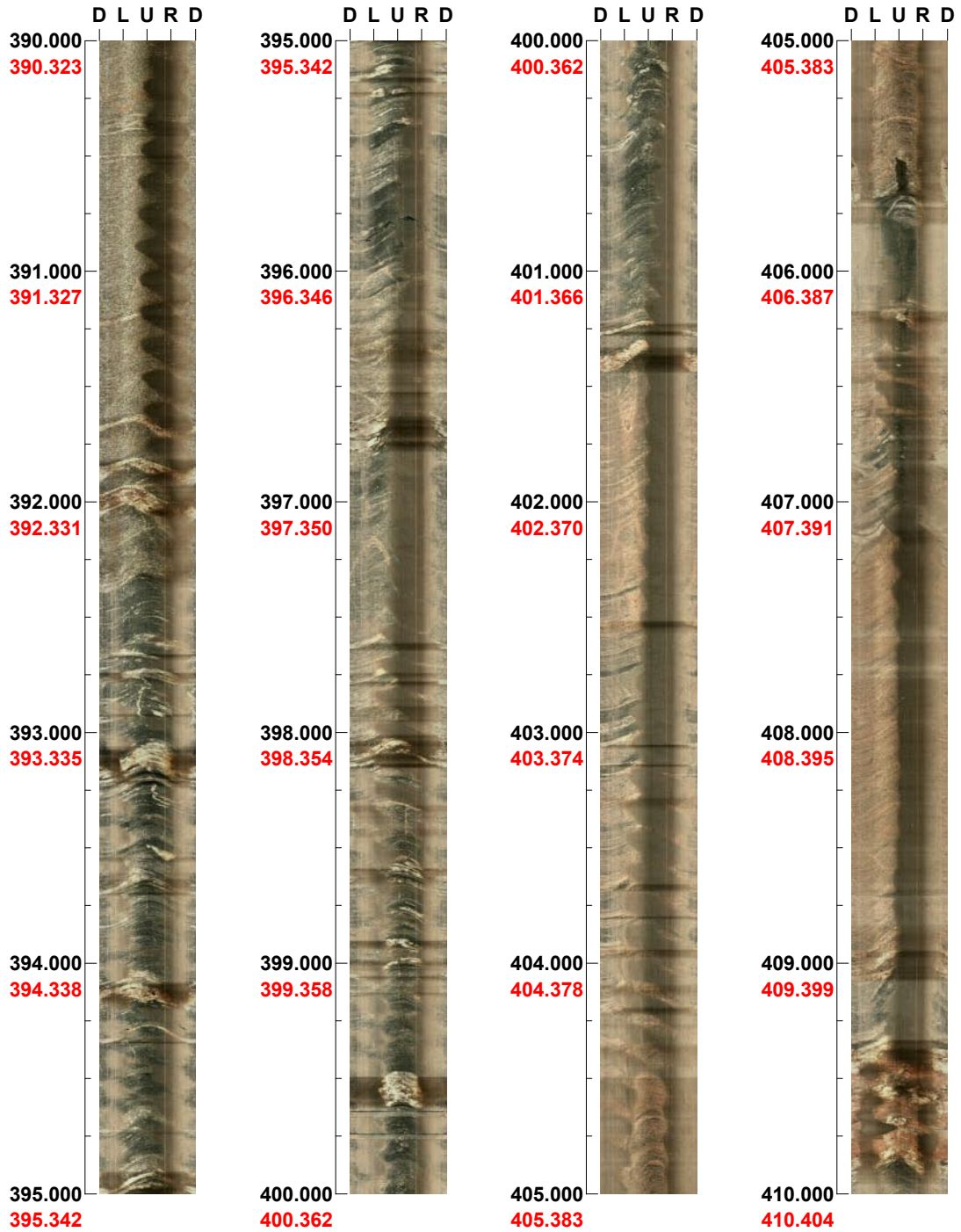

(6 / 16)

Scale: 1/25

Aspect ratio: 175 %

Project name: Forsmark
Bore hole No.: KFM04A

Azimuth: 45 Inclination: -60

Depth range: 410.000 - 430.000 m

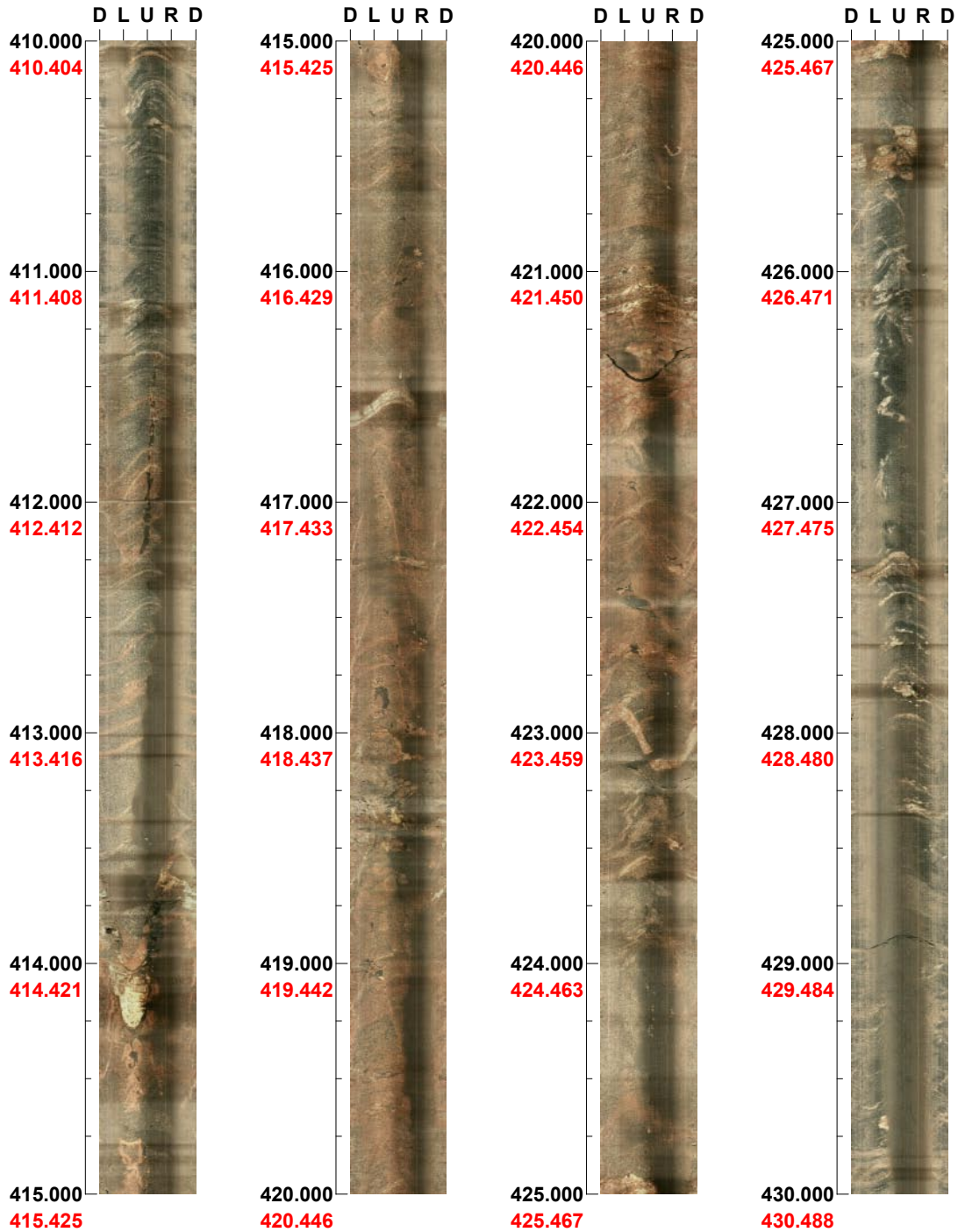

(7 / 16) Scale: 1/25 Aspect ratio: 175 %

Project name: Forsmark
Bore hole No.: KFM04A

Azimuth: 45 Inclination: -60

Depth range: 430.000 - 450.000 m



(8 / 16) Scale: 1/25 Aspect ratio: 175 %

Project name: Forsmark
Bore hole No.: KFM04A

Azimuth: 45

Inclination: -60

Depth range: 450.000 - 470.000 m

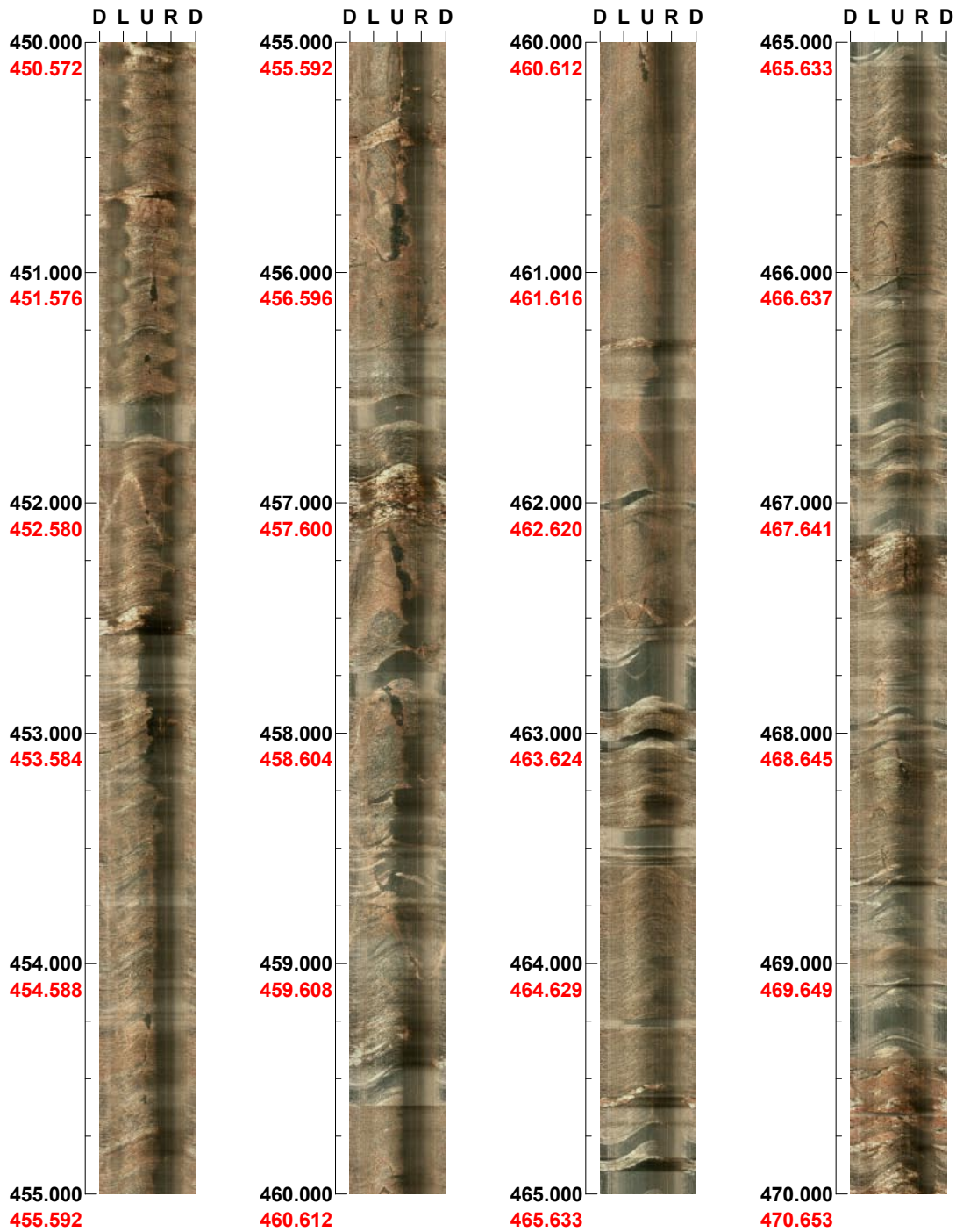

(9 / 16) Scale: 1/25 Aspect ratio: 175 %

Project name: Forsmark
Bore hole No.: KFM04A

Azimuth: 45

Inclination: -60

Depth range: 470.000 - 490.000 m



(10 / 16)

Scale: 1/25

Aspect ratio: 175 %

Project name: Forsmark
Bore hole No.: KFM04A

Azimuth: 45

Inclination: -60

Depth range: 490.000 - 510.000 m

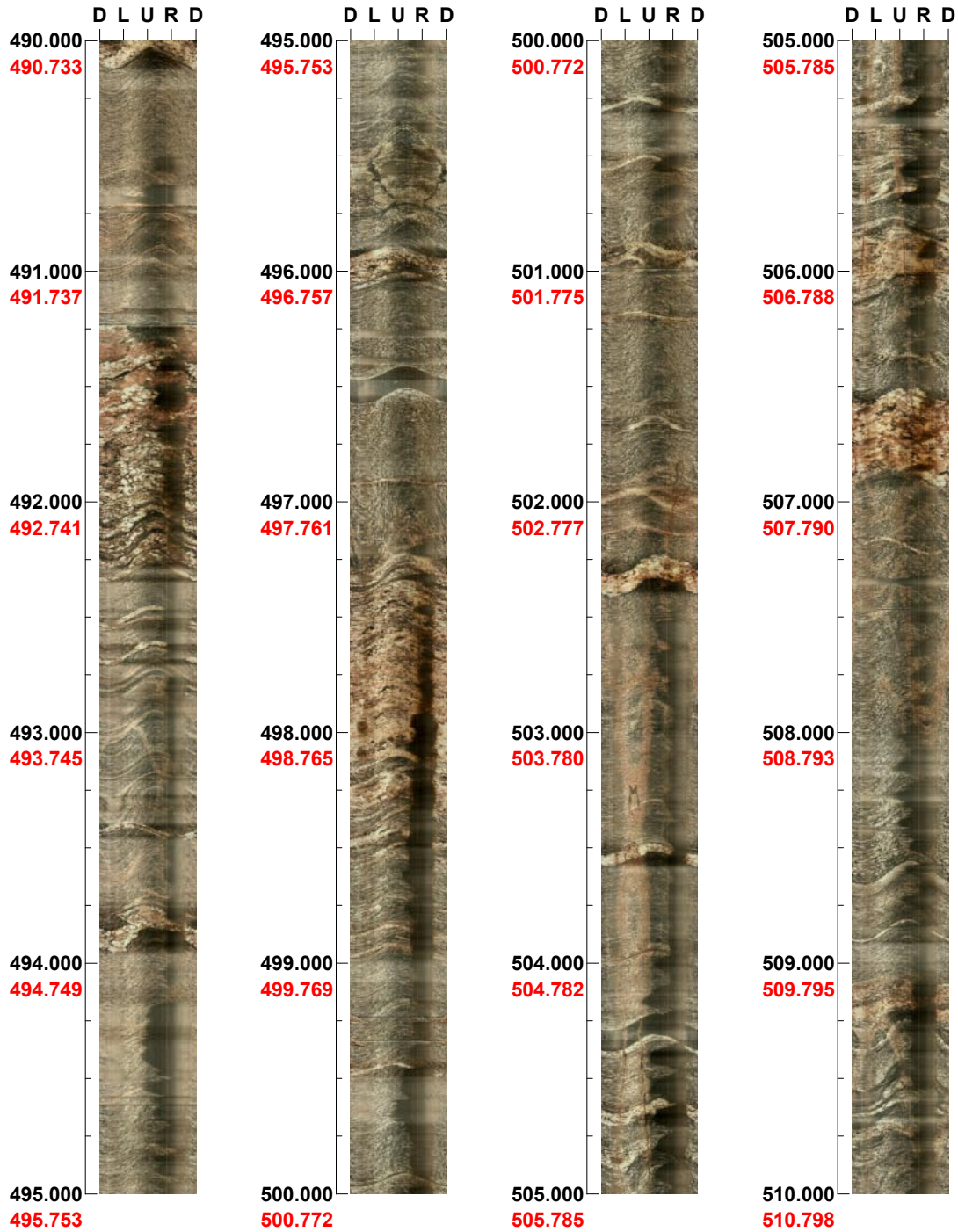

(11 / 16) Scale: 1/25 Aspect ratio: 175 %

Project name: Forsmark
Bore hole No.: KFM04A

Azimuth: 45

Inclination: -60

Depth range: 510.000 - 530.000 m



(12 / 16)

Scale: 1/25

Aspect ratio: 175 %

Project name: Forsmark
Bore hole No.: KFM04A

Azimuth: 45

Inclination: -60

Depth range: 530.000 - 550.000 m



(13 / 16) Scale: 1/25 Aspect ratio: 175 %

Project name: Forsmark
Bore hole No.: KFM04A

Azimuth: 45

Inclination: -60

Depth range: 550.000 - 570.000 m



(14 / 16)

Scale: 1/25

Aspect ratio: 175 %

Project name: Forsmark
Bore hole No.: KFM04A

Azimuth: 45

Inclination: -60

Depth range: 570.000 - 590.000 m



(15 / 16) Scale: 1/25 Aspect ratio: 175 %

Project name: Forsmark
Bore hole No.: KFM04A

Azimuth: 45

Inclination: -60

Depth range: 590.000 - 600.007 m

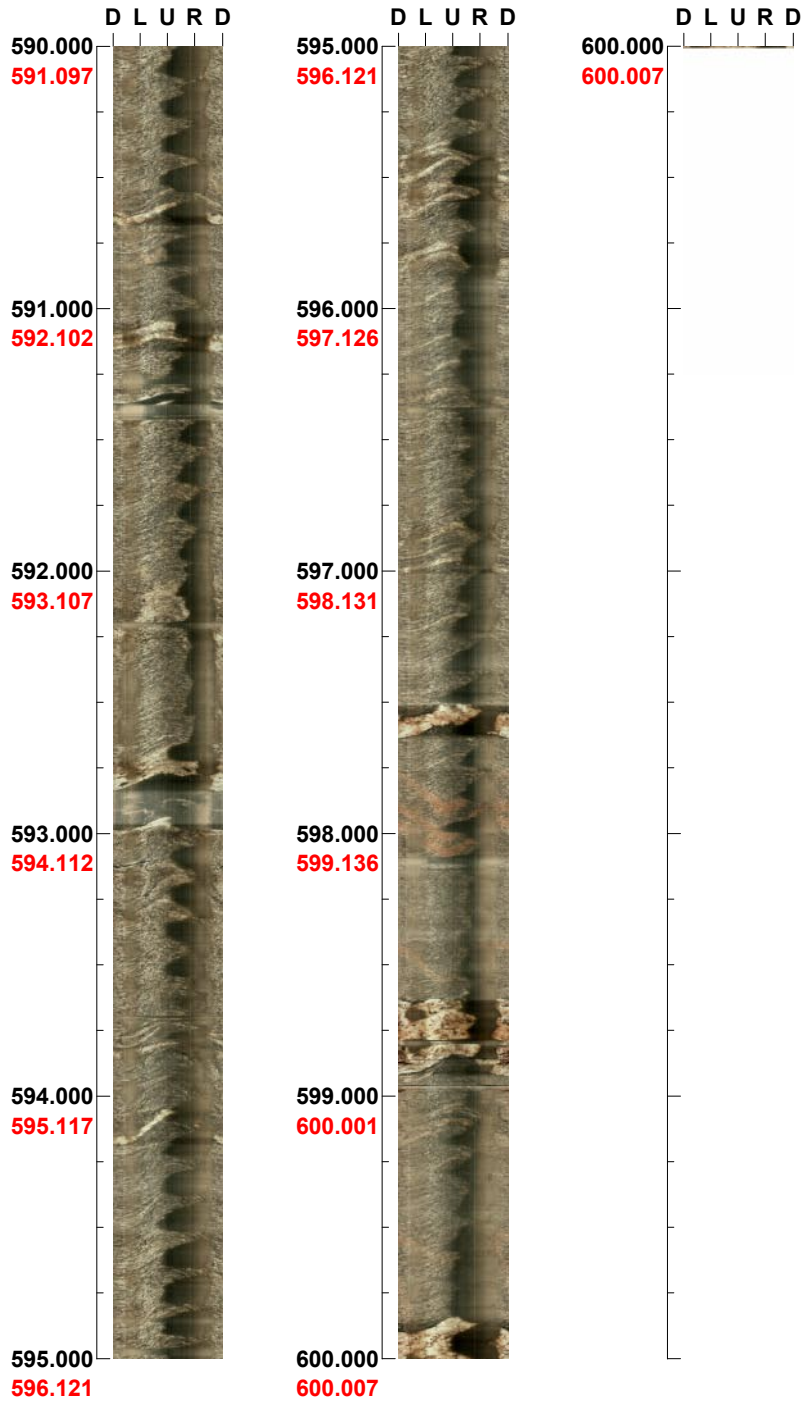

(16 / 16)

Scale: 1/25

Aspect ratio: 175 %

Project name: Forsmark
Bore hole No.: KFM04A

Azimuth: 45

Inclination: -60

Depth range: 600.000 - 620.000 m



(1 / 20) Scale: 1/25 Aspect ratio: 175 %

Project name: Forsmark
Bore hole No.: KFM04A

Azimuth: 45

Inclination: -60

Depth range: 620.000 - 640.000 m



(2 / 20)

Scale: 1/25

Aspect ratio: 175 %

Project name: Forsmark
Bore hole No.: KFM04A

Azimuth: 45

Inclination: -60

Depth range: 640.000 - 660.000 m



(3 / 20)

Scale: 1/25

Aspect ratio: 175 %

Project name: Forsmark
Bore hole No.: KFM04A

Azimuth: 45

Inclination: -60

Depth range: 660.000 - 680.000 m



(4 / 20)

Scale: 1/25

Aspect ratio: 175 %

Project name: Forsmark
Bore hole No.: KFM04A

Azimuth: 45

Inclination: -60

Depth range: 680.000 - 700.000 m



(5 / 20) Scale: 1/25 Aspect ratio: 175 %

Project name: Forsmark
Bore hole No.: KFM04A

Azimuth: 45

Inclination: -60

Depth range: 700.000 - 720.000 m

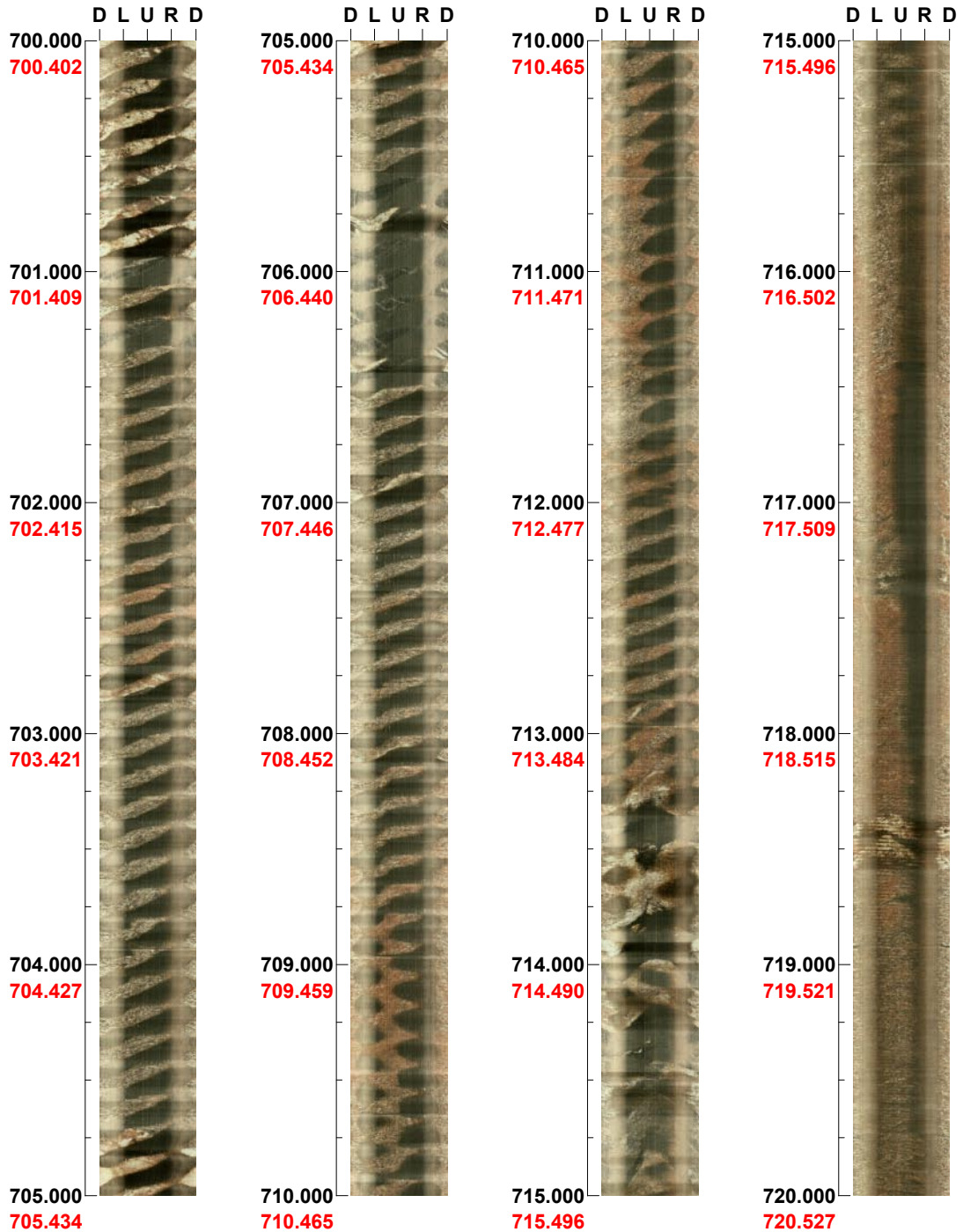

(6 / 20)

Scale: 1/25

Aspect ratio: 175 %

Project name: Forsmark
Bore hole No.: KFM04A

Azimuth: 45

Inclination: -60

Depth range: 720.000 - 740.000 m

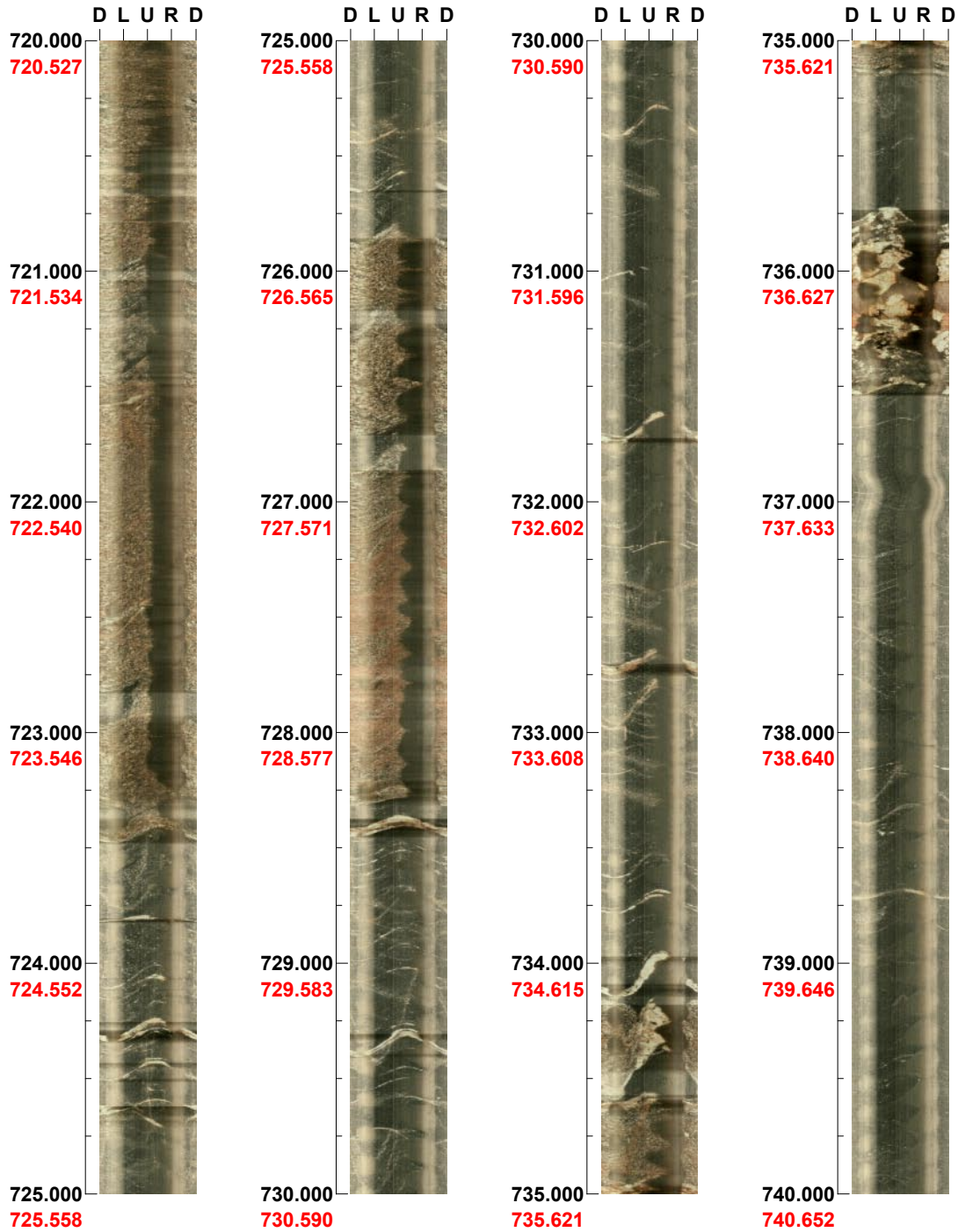

(7 / 20) Scale: 1/25 Aspect ratio: 175 %

Project name: Forsmark
Bore hole No.: KFM04A

Azimuth: 45

Inclination: -60

Depth range: 740.000 - 760.000 m



(8 / 20)

Scale: 1/25

Aspect ratio: 175 %

Project name: Forsmark
Bore hole No.: KFM04A

Azimuth: 45

Inclination: -60

Depth range: 760.000 - 780.000 m



(9 / 20) Scale: 1/25 Aspect ratio: 175 %

Project name: Forsmark
Bore hole No.: KFM04A

Azimuth: 45

Inclination: -60

Depth range: 780.000 - 800.000 m

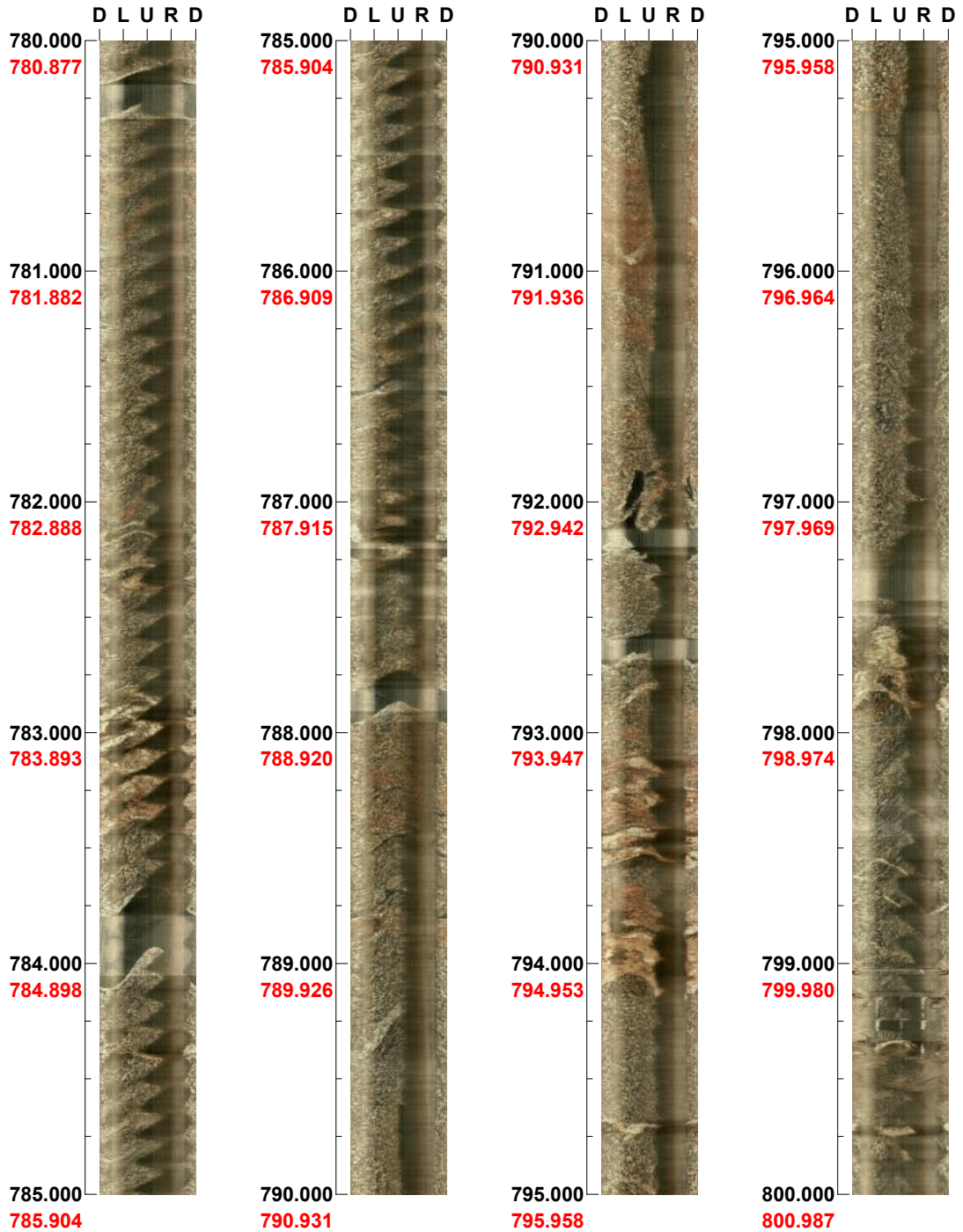

(10 / 20)

Scale: 1/25

Aspect ratio: 175 %

Project name: Forsmark
Bore hole No.: KFM04A

Azimuth: 45

Inclination: -60

Depth range: 800.000 - 820.000 m

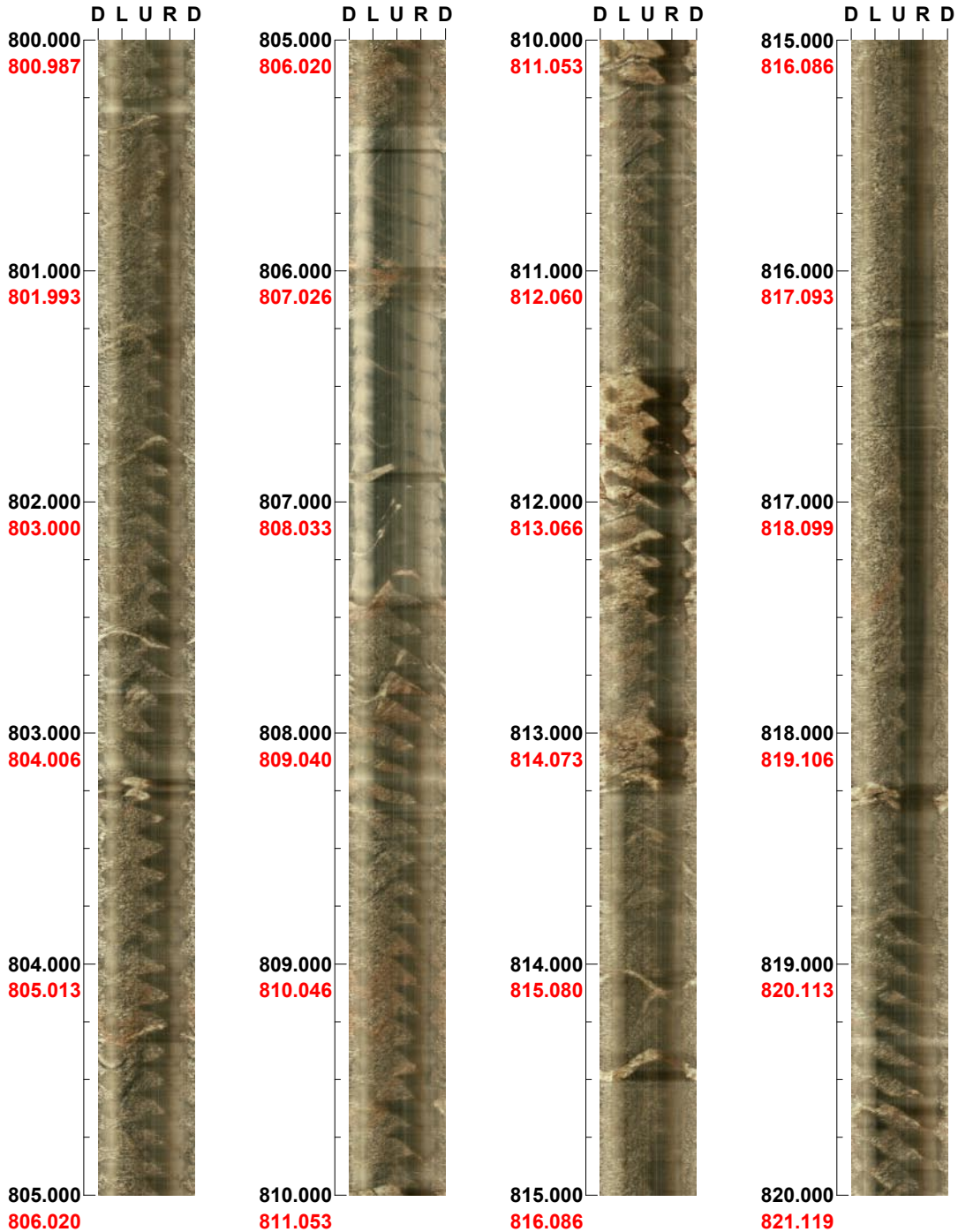

(11 / 20) Scale: 1/25 Aspect ratio: 175 %

Project name: Forsmark
Bore hole No.: KFM04A

Azimuth: 45

Inclination: -60

Depth range: 820.000 - 840.000 m



(12 / 20)

Scale: 1/25

Aspect ratio: 175 %

Project name: Forsmark
Bore hole No.: KFM04A

Azimuth: 45

Inclination: -60

Depth range: 840.000 - 860.000 m



(13 / 20) Scale: 1/25 Aspect ratio: 175 %

Project name: Forsmark
Bore hole No.: KFM04A

Azimuth: 45

Inclination: -60

Depth range: 860.000 - 880.000 m



(14 / 20)

Scale: 1/25

Aspect ratio: 175 %

Project name: Forsmark
Bore hole No.: KFM04A

Azimuth: 45

Inclination: -60

Depth range: 880.000 - 900.000 m

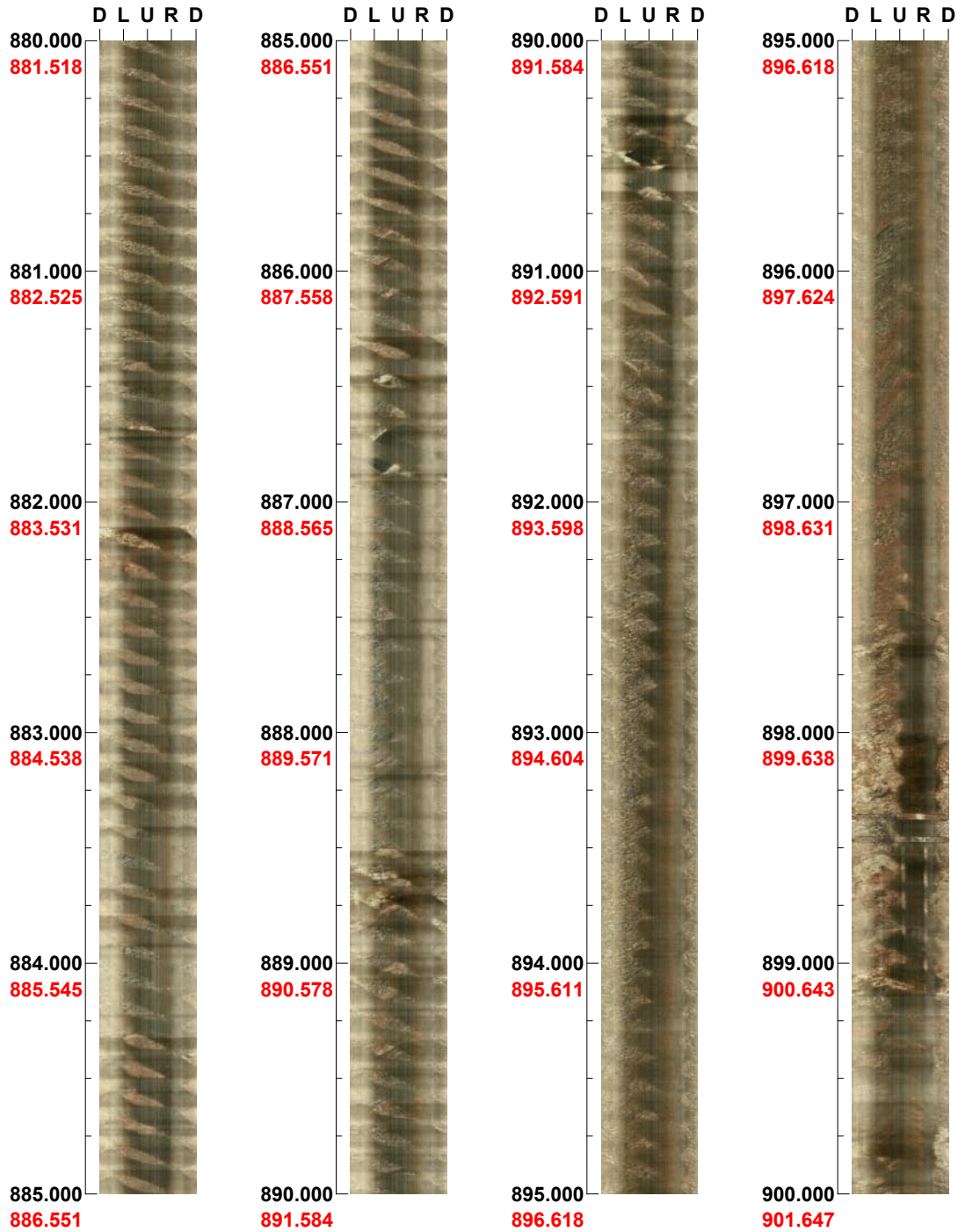

(15 / 20) Scale: 1/25 Aspect ratio: 175 %

Project name: Forsmark
Bore hole No.: KFM04A

Azimuth: 45

Inclination: -60

Depth range: 900.000 - 920.000 m



(16 / 20)

Scale: 1/25

Aspect ratio: 175 %

Project name: Forsmark
Bore hole No.: KFM04A

Azimuth: 45

Inclination: 60

Depth range: 920.000 - 940.000 m



(17 / 20) Scale: 1/25 Aspect ratio: 175 %

Project name: Forsmark
Bore hole No.: KFM04A

Azimuth: 45

Inclination: -60

Depth range: 940.000 - 960.000 m

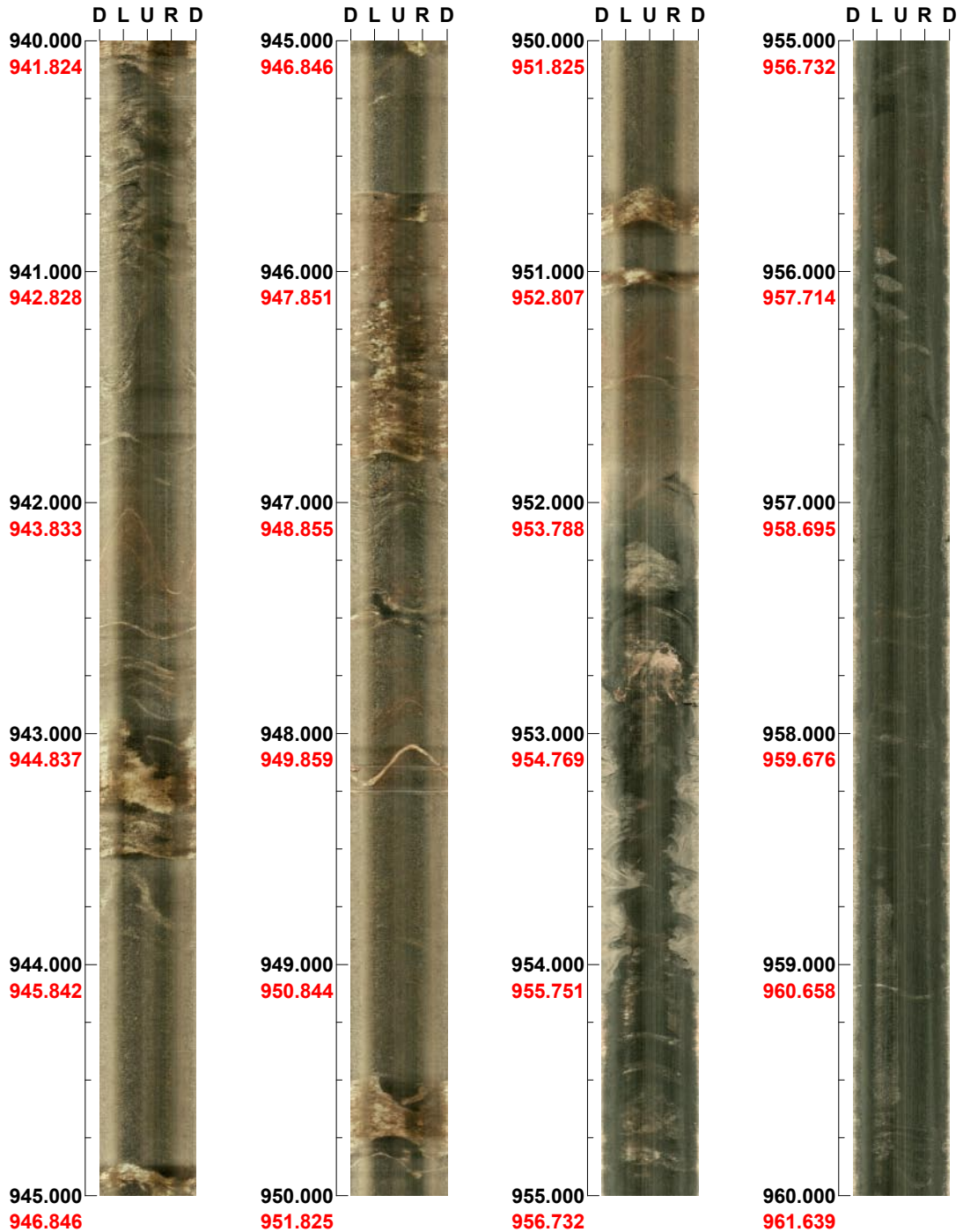

(18 / 20)

Scale: 1/25

Aspect ratio: 175 %

Project name: Forsmark
Bore hole No.: KFM04A

Azimuth: 45

Inclination: -60

Depth range: 960.000 - 980.000 m



(19 / 20) Scale: 1/25 Aspect ratio: 175 %

Project name: Forsmark
Bore hole No.: KFM04A

Azimuth: 45

Inclination: -60

Depth range: 980.000 - 997.812 m





(20 / 20)

Scale: 1/25

Aspect ratio: 175 %

BIPS logging of KFM04A, 910 to 986 m

Project name: Forsmark

Image file : c:\work\forsmark\kfm04a2.bip
BDT file : c:\work\forsmark\kfm04a2.bdt
Locality : FORSMARK
Bore hole number : KFM04A
Date : 04/05/12
Time : 00:32:00
Depth range : 910.000 - 985.875 m (red figures = corrected values)
Azimuth : 45
Inclination : -60
Diameter : 76.0 mm
Magnetic declination : 0.0
Span : 4
Scan interval : 0.25
Scan direction : To bottom
Scale : 1/25
Aspect ratio : 175 %
Pages : 7
Color :  +0  +0  +0

Project name: Forsmark
Bore hole No.: KFM04A

Azimuth: 45

Inclination: -60

Depth range: 910.000 - 930.000 m



(4 / 7) Scale: 1/25 Aspect ratio: 175 %

Project name: Forsmark
Bore hole No.: KFM04A

Azimuth: 45

Inclination: -60

Depth range: 930.000 - 950.000 m



(5 / 7)

Scale: 1/25

Aspect ratio: 175 %

Project name: Forsmark
Bore hole No.: KFM04A

Azimuth: 45

Inclination: -60

Depth range: 950.000 - 970.000 m



(6 / 7) Scale: 1/25 Aspect ratio: 175 %

Project name: Forsmark
Bore hole No.: KFM04A

Azimuth: 45

Inclination: -60

Depth range: 970.000 - 985.875 m





(7 / 7)

Scale: 1/25

Aspect ratio: 175 %

BIPS logging of KFM04B, 10 to 99.9 m

Project name: Forsmark

Image file : h:\work\kfm04b~1\bips\kfm04b.bip
BDT file : h:\work\kfm04b~1\bips\kfm04b.bdt
Locality : FORSMARK
Bore hole number : KFM04B
Date : 03/06/04
Time : 07:05:00
Depth range : 10.000 - 99.867 m (red figures = corrected values)
Azimuth : 0
Inclination : -60
Diameter : 165.0 mm
Magnetic declination : 0.0
Span : 4
Scan interval : 0.25
Scan direction : To bottom
Scale : 1/25
Aspect ratio : 85 %
Pages : 5
Color :  +0  +0  +0

Project name: Forsmark
Bore hole No.: KFM04B

Azimuth: 0

Inclination: -60

Depth range: 10.000 - 30.000 m

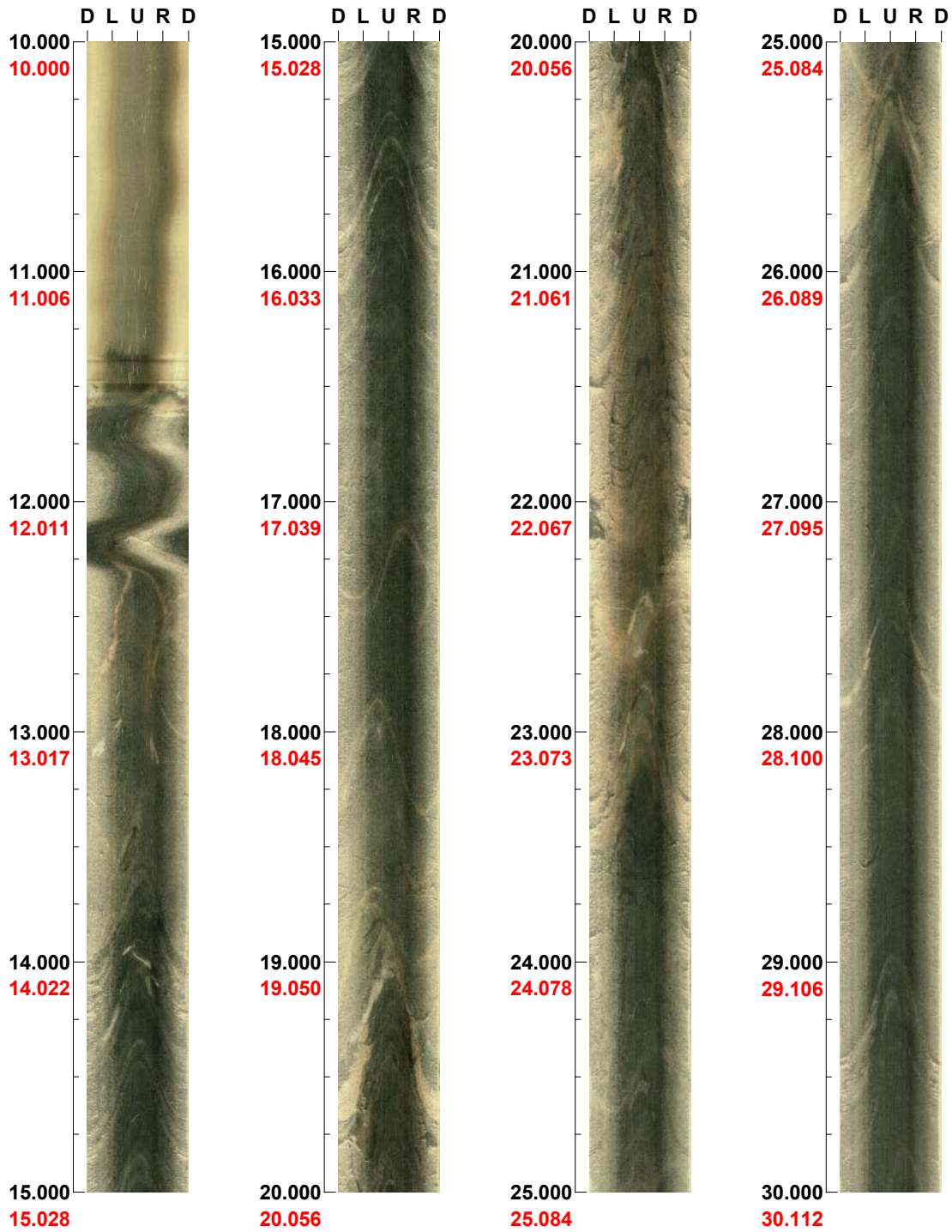

(1 / 5) Scale: 1/25 Aspect ratio: 85 %

Project name: Forsmark
Bore hole No.: KFM04B

Azimuth: 0

Inclination: -60

Depth range: 30.000 - 50.000 m



(2 / 5)

Scale: 1/25

Aspect ratio: 85 %

Project name: Forsmark
Bore hole No.: KFM04B

Azimuth: 0

Inclination: -60

Depth range: 50.000 - 70.000 m



(3 / 5) Scale: 1/25 Aspect ratio: 85 %

Project name: Forsmark
Bore hole No.: KFM04B

Azimuth: 0

Inclination: -60

Depth range: 70.000 - 90.000 m



(4 / 5)

Scale: 1/25

Aspect ratio: 85 %

Project name: Forsmark
Bore hole No.: KFM04B

Azimuth: 0

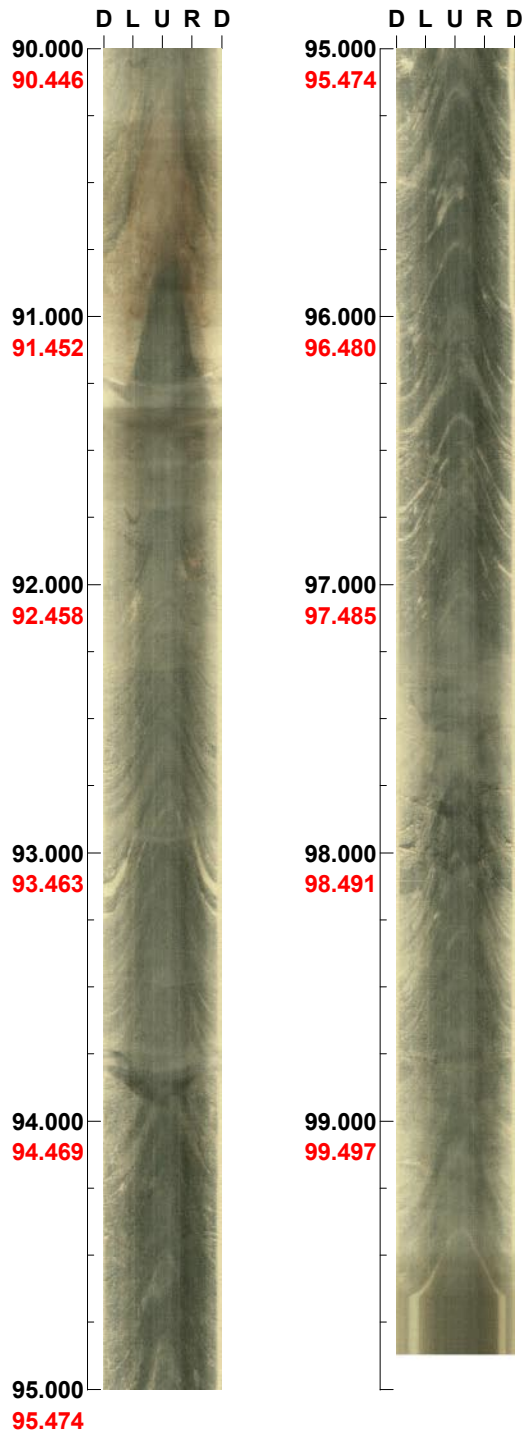

Inclination: -60

Depth range: 90.000 - 99.867 m



(5 / 5) Scale: 1/25 Aspect ratio: 85 %

BIPS logging of HFM09, 16 to 49.8 m**Project name: Forsmark**

Image file : h:\work\hfm09\bips\hfm09.bip
BDT file : h:\work\hfm09\bips\hfm09.bdt
Locality : FORSMARK
Bore hole number : HFM09
Date : 03/09/04
Time : 11:15:00
Depth range : 16.000 - 49.786 m (red figures = corrected values)
Azimuth : 135
Inclination : -70
Diameter : 140.0 mm
Magnetic declination : 0.0
Span : 4
Scan interval : 0.25
Scan direction : To bottom
Scale : 1/25
Aspect ratio : 100 %
Pages : 2
Color :  +0  +0  +0

Project name: Forsmark
Bore hole No.: HFM09

Azimuth: 135

Inclination: -70

Depth range: 16.000 - 36.000 m

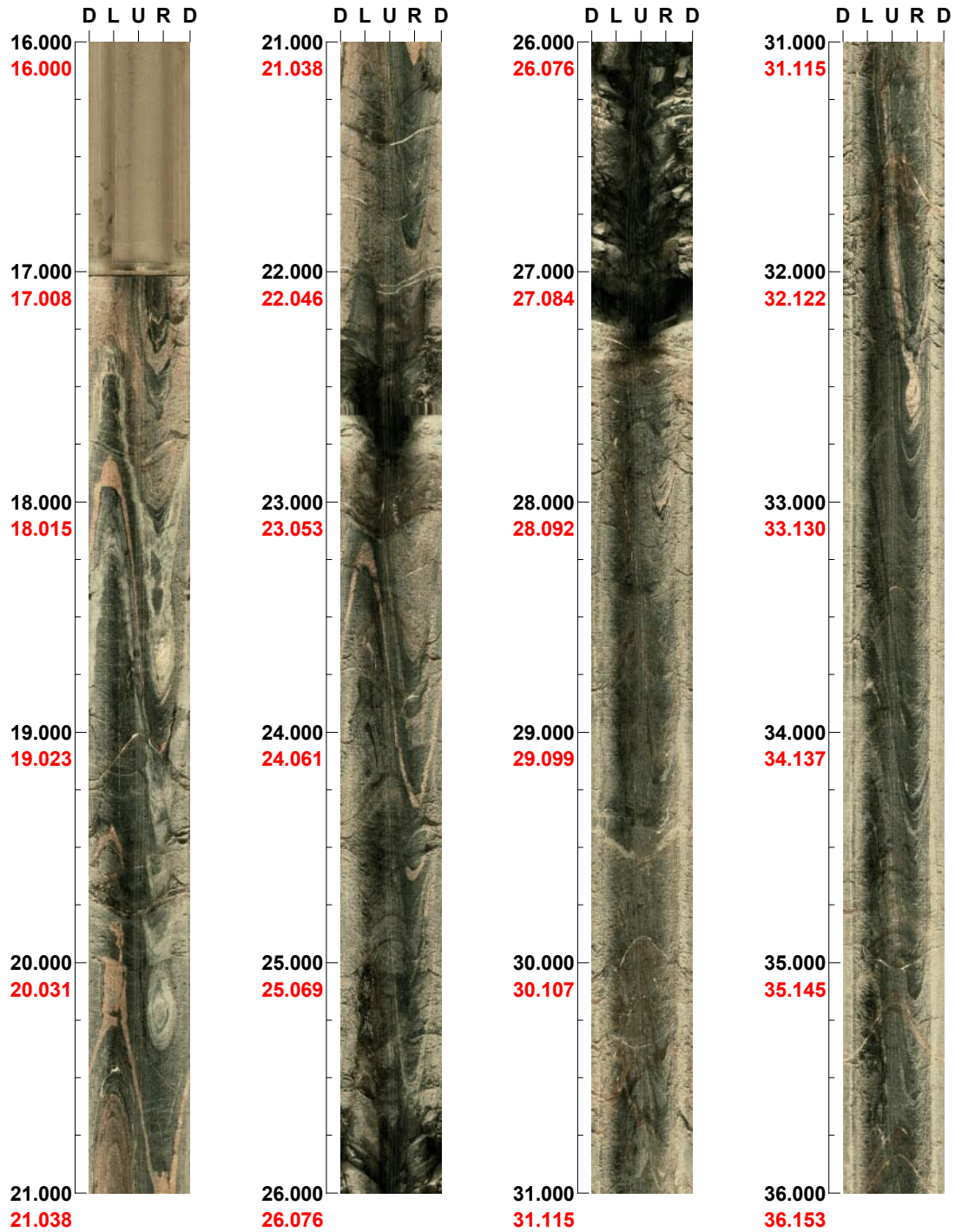

(1 / 2)

Scale: 1/25

Aspect ratio: 100 %

Project name: Forsmark
Bore hole No.: HFM09

Azimuth: 135 Inclination: -70

Depth range: 36.000 - 49.786 m

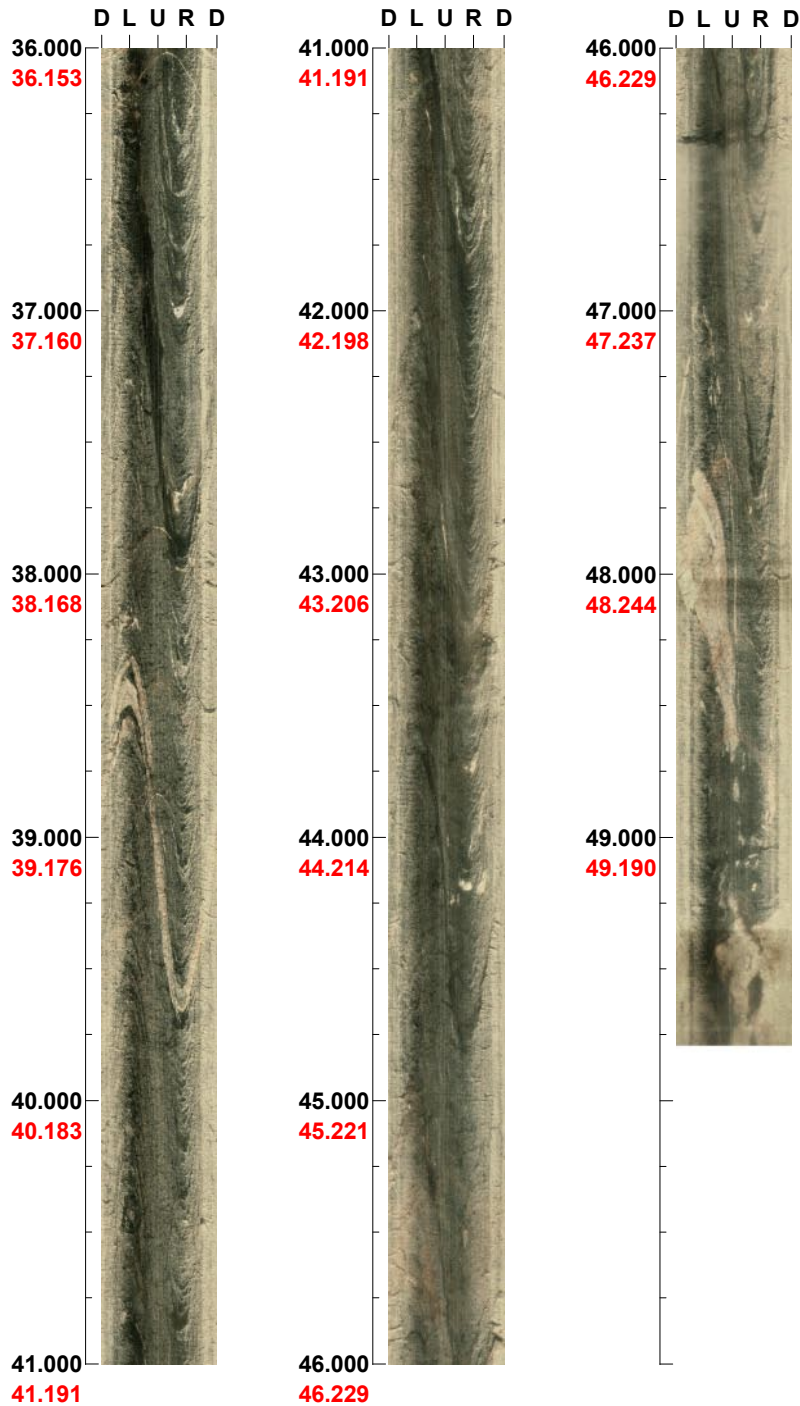

(2 / 2) Scale: 1/25 Aspect ratio: 100 %

BIPS logging of HFM10, 11 to 148.9 m

Project name: Forsmark

Image file : h:\work\hfm10\bips\hfm10.bip
BDT file : h:\work\hfm10\bips\hfm10.bdt
Locality : FORSMARK
Bore hole number : HFM10
Date : 03/08/29
Time : 19:46:00
Depth range : 11.000 - 148.890 m (red figures = corrected values)
Azimuth : 0
Inclination : -70
Diameter : 140.0 mm
Magnetic declination : 0.0
Span : 4
Scan interval : 0.25
Scan direction : To bottom
Scale : 1/25
Aspect ratio : 100 %
Pages : 7
Color : 
 +0 +0 +0

Project name: Forsmark
Bore hole No.: HFM10

Azimuth: 0

Inclination: -70

Depth range: 11.000 - 31.000 m



(1 / 7) Scale: 1/25 Aspect ratio: 100 %

Project name: Forsmark
Bore hole No.: HFM10

Azimuth: 0

Inclination: -70

Depth range: 31.000 - 51.000 m

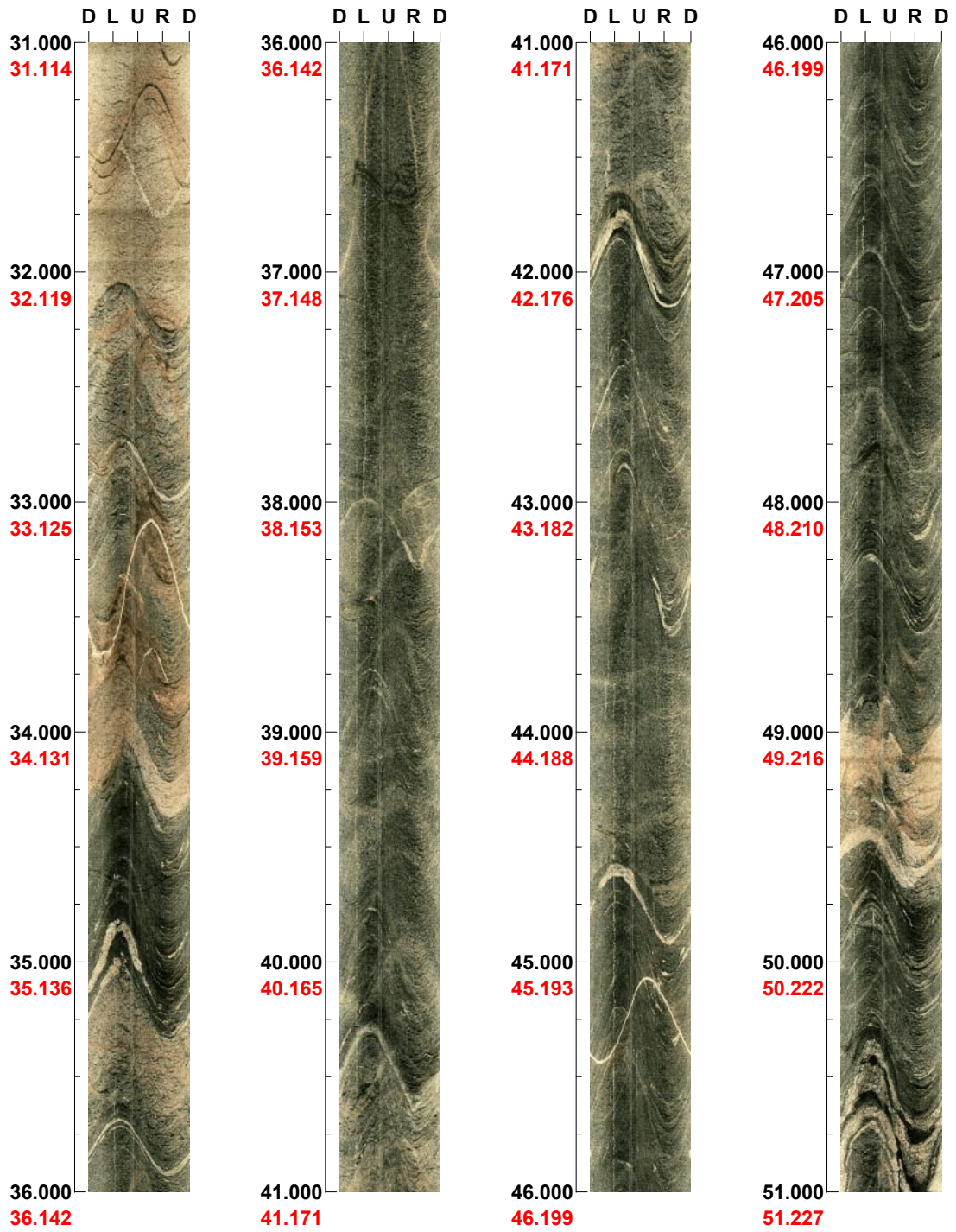

(2 / 7)

Scale: 1/25

Aspect ratio: 100 %

Project name: Forsmark
Bore hole No.: HFM10

Azimuth: 0

Inclination: -70

Depth range: 51.000 - 71.000 m



(3 / 7) Scale: 1/25 Aspect ratio: 100 %

Project name: Forsmark
Bore hole No.: HFM10

Azimuth: 0

Inclination: -70

Depth range: 71.000 - 91.000 m

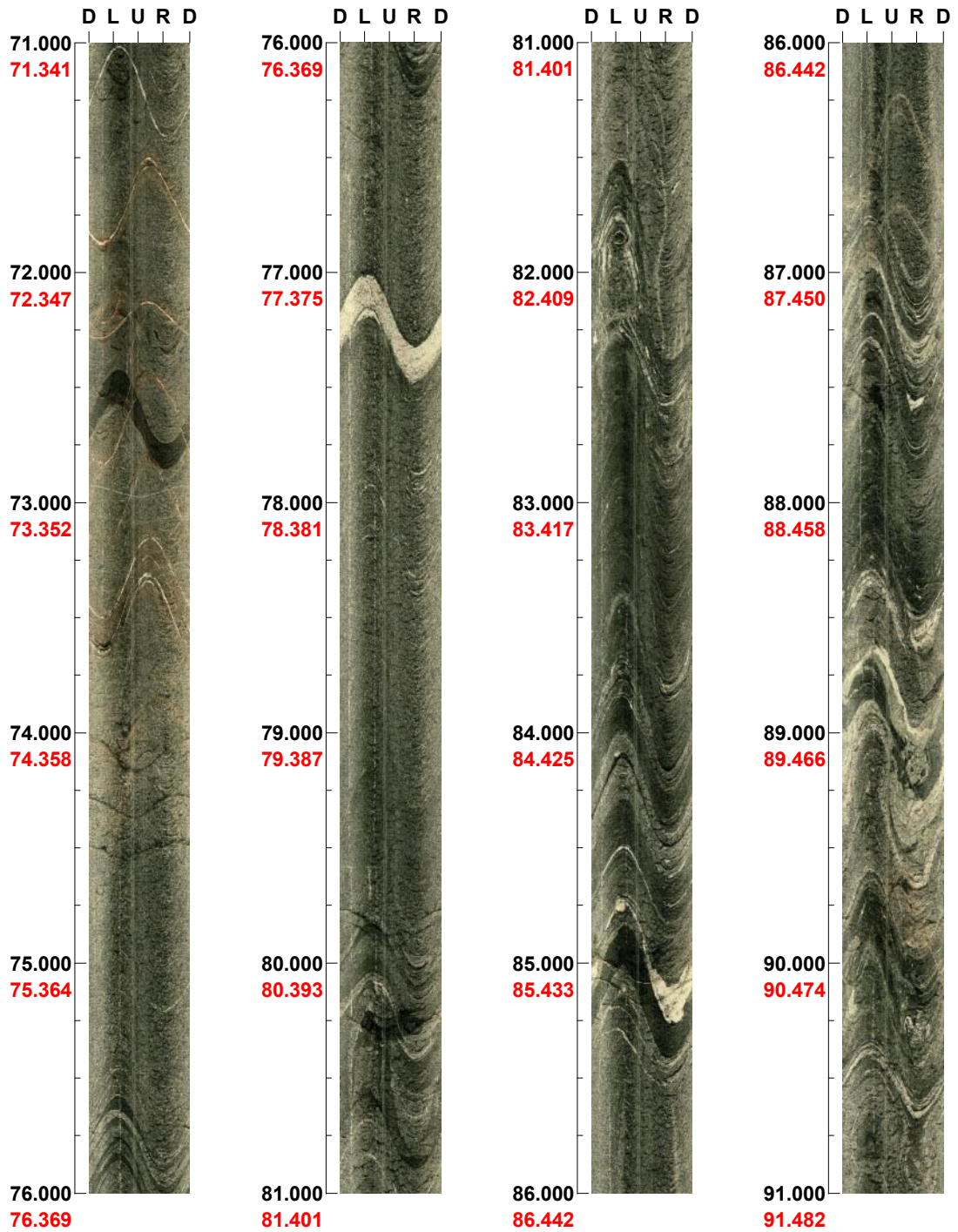

(4 / 7)

Scale: 1/25

Aspect ratio: 100 %

Project name: Forsmark
Bore hole No.: HFM10

Azimuth: 0

Inclination: -70

Depth range: 91.000 - 111.000 m

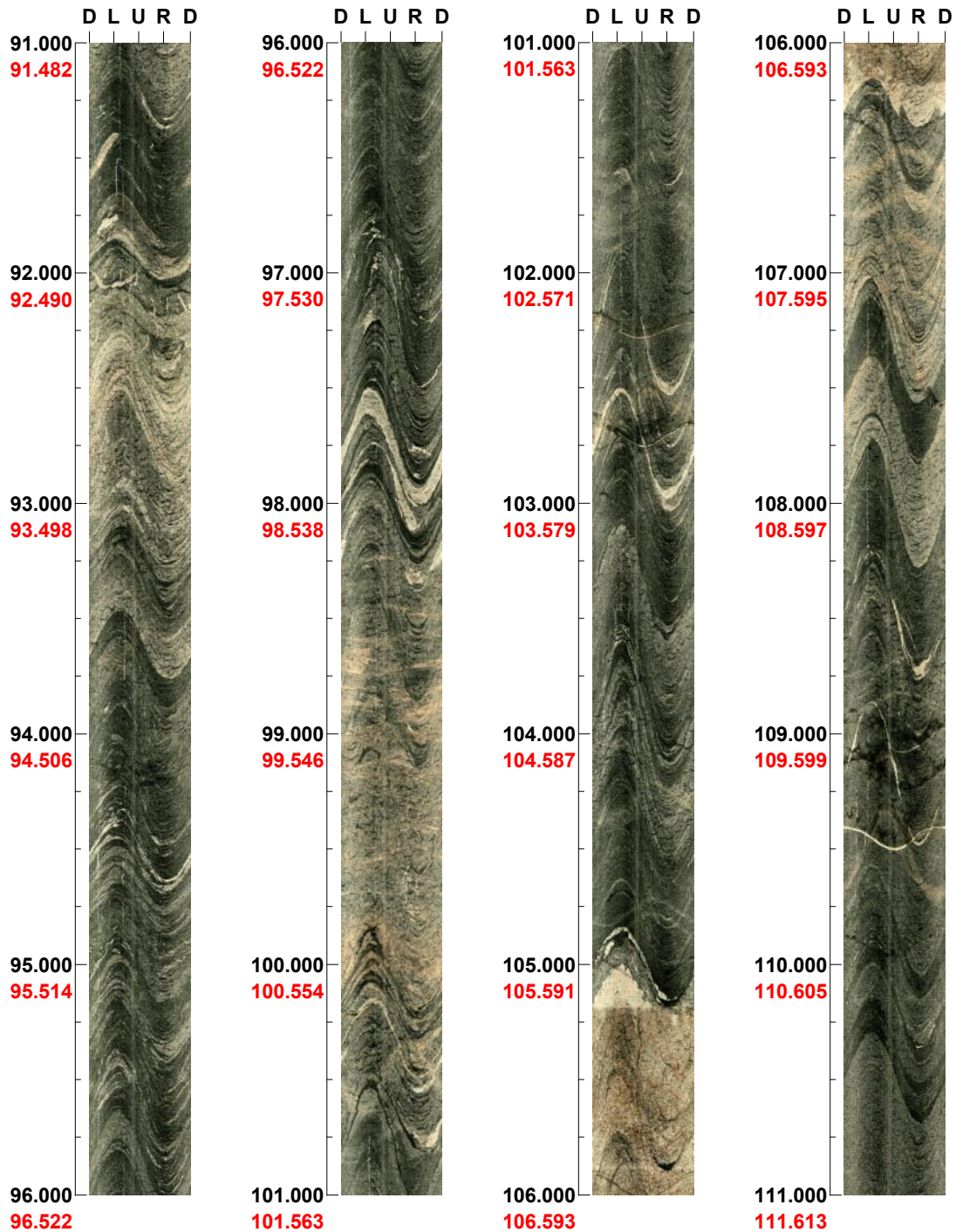

(5 / 7) Scale: 1/25 Aspect ratio: 100 %

Project name: Forsmark
Bore hole No.: HFM10

Azimuth: 0

Inclination: -70

Depth range: 111.000 - 131.000 m

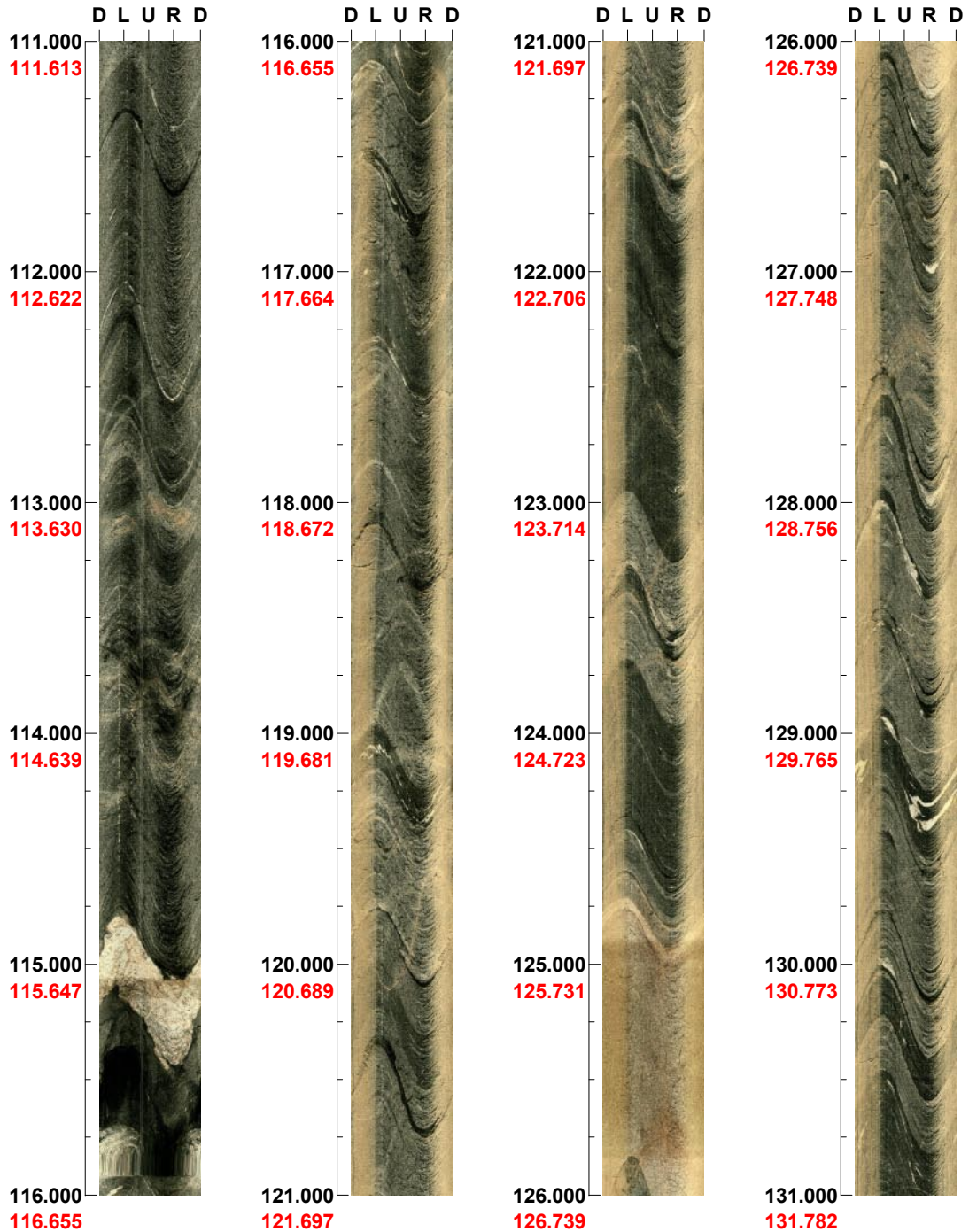

(6 / 7)

Scale: 1/25

Aspect ratio: 100 %

Project name: Forsmark
Bore hole No.: HFM10

Azimuth: 0

Inclination: -70

Depth range: 131.000 - 148.890 m

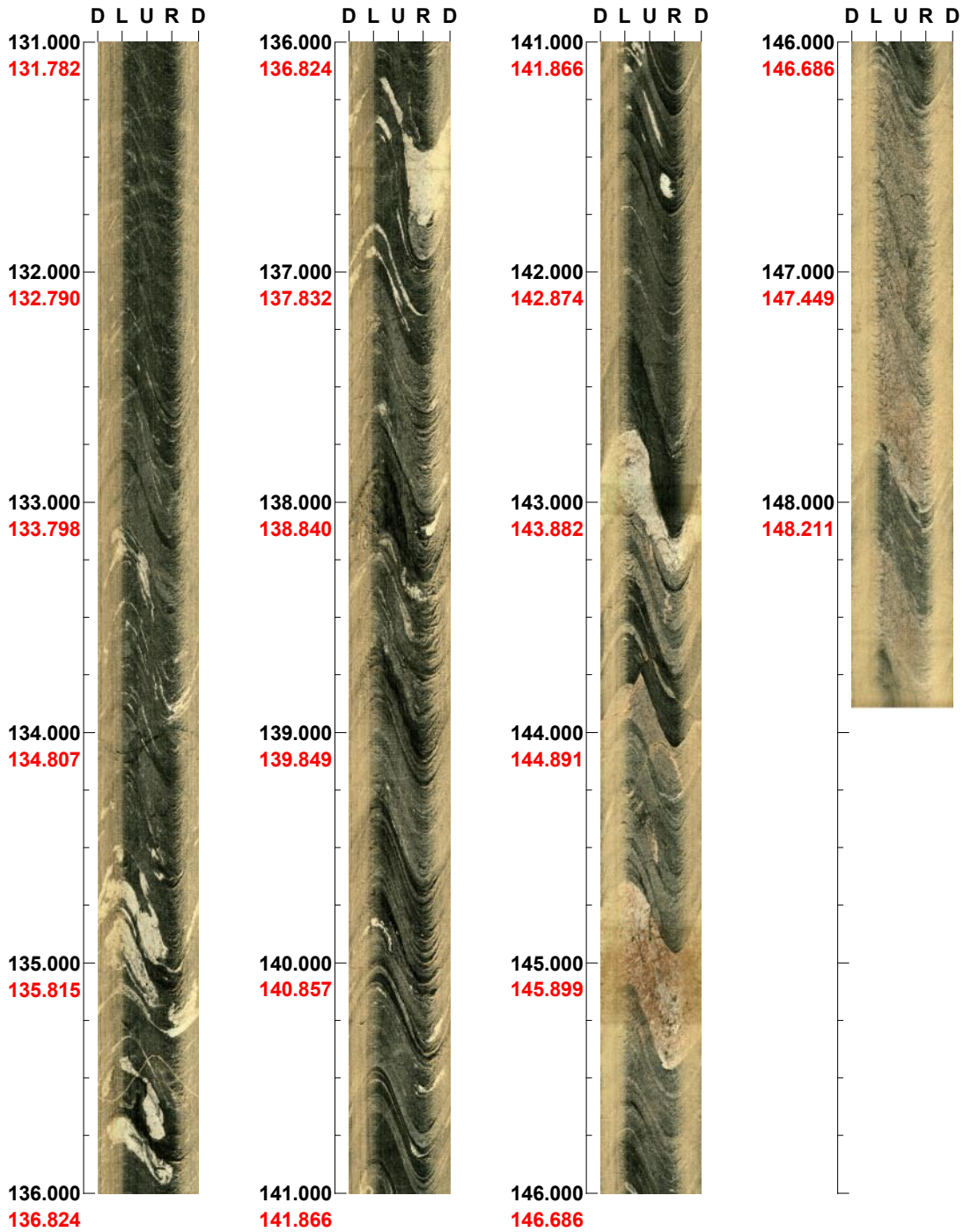

(7 / 7) Scale: 1/25 Aspect ratio: 100 %