

Technical Report

TR-10-16

**Design, production and initial
state of the backfill and plug
in deposition tunnels**

Svensk Kärnbränslehantering AB

December 2010

Svensk Kärnbränslehantering AB

Swedish Nuclear Fuel
and Waste Management Co

Box 250, SE-101 24 Stockholm
Phone +46 8 459 84 00



ISSN 1404-0344

SKB TR-10-16

ID 1177184

Updated 2013-10

Design, production and initial state of the backfill and plug in deposition tunnels

Svensk Kärnbränslehantering AB

December 2010

Keywords: Backfill, Plug in deposition tunnel, Safety report, Design premise, Verification, Verifying analysis, Reference design, Production, Manufacturing, Inspection, Initial state.

A pdf version of this document can be downloaded from www.skb.se.

Update notice

The original report, dated December 2010, was found to contain factual which have been corrected in this updated version. The corrected factual errors are presented below.

Updated 2013-10

Location	Original text	Corrected text
Page 37, Figure 3-3	Arrow is missing from the word Blocks	Figure updated with an arrow
Page 64, Figure 5-11	Illustration shows two blocks in the upper part	Figure updated and shows now two and a half blocks in the upper part

Preface

An important part of SKB's licence application for the construction, possession and operation of the KBS-3 repository is the safety report. The safety report addresses both safety during operation of the KBS-3 repository facility (**SR-Operation**), and the long-term safety of the KBS-3 repository (**SR-Site**).

For the construction of the KBS-3 repository SKB has defined a set of production lines:

- the spent nuclear fuel,
- the canister,
- the buffer,
- the backfill,
- the closure, and
- the underground openings.

These production lines are reported in separate *Production reports*, and in addition there is a *Repository production report* presenting the common basis for the reports.

This set of reports addresses design premises, reference design, conformity of the reference design to design premises, production and the initial state, i.e. the results of the production. Thus the reports provide input to **SR-Site** concerning the characteristics of the as built KBS-3 repository and to **SR-Operation** concerning the handling of the engineered barriers and construction of underground openings.

The preparation of the set of reports has been lead and coordinated by Lena Morén with support from Roland Johansson, Karin Pers and Marie Wiborgh.

This report has been authored by Lennart Börjesson, David Gunnarsson, Lars-Erik Johannesson and Esther Jonsson.

Summary

The report is included in a set of *Production reports*, presenting how the KBS-3 repository is designed, produced and inspected. The set of reports is included in the safety report for the KBS-3 repository and repository facility.

The report provides input on the *initial state* of the backfill and plug in deposition tunnels for the assessment of the long-term safety, **SR-Site**. The initial state refers to the properties of the engineered barriers once they have been finally placed in the KBS-3 repository and will not be further handled within the repository facility. In addition, the report provides input to the operational safety report, **SR-Operation**, on how the backfill and plug shall be handled and installed.

The report presents the design premises and reference designs of the backfill and plug in deposition tunnels and verifies their conformity to the design premises. It also describes the production of the backfill from excavation and delivery of backfill material to installation in the deposition tunnel, and gives an outline of the installation of the plug. Finally, the initial states of the backfill and plug and their conformity to the reference designs and design premises are presented.

Design premises for the backfill and plug in deposition tunnels

The design premises are based on regulations; the functions of the KBS-3 repository; the design basis cases from the assessment of the long-term safety; the design basis events from the assessment of the operational safety; technical feasibility and the planned production.

In the KBS-3 repository the backfill shall sustain the multi-barrier principle by keeping the buffer in place and limit groundwater flow through the deposition tunnels. The properties of the backfill of most importance for its barrier functions are its hydraulic conductivity, swelling pressure and compressibility. These properties are related to its montmorillonite content and density. Acceptable conductivity, swelling pressure and compressibility are provided from the assessment of the long-term safety. According to the design premises the design shall maintain the specified properties with a margin for loss of material.

The plug shall close the deposition tunnels, keep the backfill in them in place and prevent water flow past the plug until the main tunnel has been filled and saturated. The most important properties for the functions of the plug are its water tightness and strength. The plug shall maintain its functions during the operational phases of the KBS-3 repository facility. It has no barrier function in the KBS-3 repository but it must not decrease significantly in volume or contain materials that may impact the barrier functions of the engineered barriers or rock.

The backfill and plug shall also be designed to conform to design premises related to production and operation of the repository facility. With respect to technical feasibility the backfill and plug impose design premises for the deposition tunnels.

The reference design of the backfill and its conformity to the design premises

The reference material used for the backfill is bentonite clay with a nominal montmorillonite of content of 50–60 wt-% and an acceptable variation within 45–90%. The installed backfill consists of compacted blocks stacked on a compacted flat bed of bentonite pellets. The gap between the blocks and the rock surface is filled with bentonite pellets. To achieve a sufficient installed density for the specified material at least 60% of the tunnel volume consists of blocks.

The conformity of the reference design to the design premises has been verified by means of calculations and laboratory tests. The relations between density and hydraulic conductivity, swelling pressure and compressibility respectively have been investigated for alternative materials with the montmorillonite content specified for the reference material. It is concluded that bentonite clays with the specified montmorillonite content conforms to the design premises.

The production of the backfill

The methods to manufacture backfill components and to inspect their properties are based on established technique from similar industrial applications. The reference method to manufacture blocks is uniaxial compression and the reference method to manufacture pellets is roller compaction of small briquettes. The bottom bed is installed by a screw feeder and compacted to a flat layer. The blocks are installed layer by layer by a lifting tool, and the pellets are sprayed into the space between the blocks and the rock surface.

The production of the backfill comprises the main parts excavation and delivery; manufacturing of blocks and pellets and handling and installation. Each main part is divided into several stages. Production-inspection schemes describing the processes performed to alter and/or inspect the backfill design parameters in each stage are included in the report.

Experiences and results from performed material deliveries, test manufacturing and installation show that material, backfill components and installed backfill in conformity to the specification for the reference design can be achieved. To keep the variation in density of blocks and pellets low the manufacturing need to be adapted to the selected material and also to the material deliveries.

The initial state of the backfill

The initial state of the backfill is the state when the entire deposition tunnel is backfilled. The initial state will depend on the composition of the backfill material, the dimensions and density of the installed backfill components, the portions of the tunnel filled with blocks and pellets as well as on the dimensions of the deposition tunnels. To describe the backfill at the initial state the material composition and the block and pellet dimensions and densities that can be expected based on current experiences are combined with the tunnel geometries that can be expected based on experiences from the construction of deposition tunnels. The installed density is calculated from the expected tunnel volume and the resulting block and pellet portions.

Experiences show that material with montmorillonite content within the interval specified for the reference design can be delivered, and its composition inspected with sufficient accuracy. Blocks and pellets with acceptable variation in dimensions and density can be manufactured.

The installed density mainly depends on the block filled part of the deposition tunnel volume. Based on current experiences the block filled part will be 67–79% which, with a margin for material loss, will result in an installed density sufficient to maintain the conductivity, swelling pressure and compressibility specified in the design premises.

The reference design of the plug and its conformity to the design premises

The reference plug consists of a concrete plug, a watertight seal, a filter, drainage pipes and concrete beams. The concrete plug shall resist deformation and keep the watertight seal, filter and backfill in place. The watertight seal consists of bentonite blocks and pellets and shall seal leakage paths and take up the water pressure gradient over the plug so that no unfavourable water pressure is applied in the interface between the rock and the concrete, and so that the water pressure within the backfilled deposition tunnel is equalised. The filter consists of sand or gravel and shall collect water leaking out from the backfill and, if required, drain it through the drainage pipes until the concrete plug has gained full strength. The concrete beams facilitate the installation of the plug.

The conformity of the reference plug to the design premises shall be verified for the three phases of its lifetime – the curing, sealing and post closure phases. During the curing phase it shall be verified that the concrete cures without formation of cracks and that water can be drained passed the concrete plug until it has gained full strength, if required. During the sealing phase it shall be verified that buffer and backfill material is prevented from passing the plug and that it resists the occurring mechanical loads without significant deformation. For the post closure phase it shall be verified that the plug will not impact the barrier functions of the engineered barriers or rock. The verifying analyses comprise calculations and tests and show that the reference plug conforms to the design premises.

The production of the plug

The production of the plug is based on established technique from similar applications and follows generally applied procedures. With respect to the long-term safety it is important that the materials for the plug are carefully specified and that they are inspected at delivery. During the curing phase it is important that the installations are performed in accordance to specifications and that the temperature of the concrete is controlled. To limit transport of buffer and backfill material out from the deposition tunnel it is important that the plug is installed without interruptions immediately after the installation of the backfill is finished.

Initial state of the plug

In the final repository the plugs can be regarded as engineered materials left in the repository. The plug will not contain materials that may impact the barrier functions of the engineered barriers or rock, and it will fill the volume between the backfill and the closure in the main tunnel.

Sammanfattning

Rapporten ingår i en grupp av *Produktionsrapporter* som redovisar hur KBS-3-förvaret är utformat, producerat och kontrollerat. Gruppen av rapporter ingår i säkerhetsredovisningen för KBS-3-förvaret och förvarsanläggningen.

Rapporten redovisar indata om *initialtillståndet* för återfyllning och plugg i deponeringstunnlar för analysen av långsiktig säkerhet, **SR-Site**. Initialtillståndet avser egenskaperna hos de tekniska barriärerna då de slutligt satts på plats i slutförvaret och ej hanteras ytterligare inom slutförvarsanläggningen. Dessutom ger rapporten information till driftsäkerhetsredovisningen, **SR-Drift**, om hur återfyllning och plugg i deponeringstunnlar ska hanteras och installeras.

Rapporten redovisar återfyllningens och pluggens konstruktionsförutsättningar och referensutformningar, och verifierar deras överensstämmelse med konstruktionsförutsättningarna. Den beskriver också produktionen av återfyllningen, från brytning och leverans av material till installation i deponeringstunneln, och ger en översikt över installationen av pluggen. Slutligen redovisas återfyllningens och pluggens initialtillstånd och deras överensstämmelse med referensutformningen och konstruktionsförutsättningarna.

Konstruktionsförutsättningar för återfyllning och plugg i deponeringstunnlar

Konstruktionsförutsättningarna är baserade på föreskrifter, KBS-3-förvarets funktioner, konstruktionsstyrande fall från analysen av långsiktig säkerhet, konstruktionsstyrande händelser från redovisningen av driftsäkerhet, teknisk genomförbarhet och den planerade produktionen.

I KBS-3-förvaret ska återfyllningen upprätthålla flerbarriärsprincipen genom att hålla bufferten på plats och begränsa vattenflöde genom deponeringstunnlarna. De egenskaper hos återfyllningen som har störst betydelse för dess barriärfunktioner är dess hydrauliska konduktivitet, svälltryck och kompressibilitet. Dessa egenskaper är relaterade till dess montmorillonithalt och densitet. Acceptabel konduktivitet, svälltryck och kompressibilitet ges från analysen av långsiktig säkerhet. Enligt konstruktionsförutsättningarna ska utformningen upprätthålla angivna egenskaper med marginal för materialförlust.

Pluggen ska försluta deponeringstunneln och hålla återfyllningen i denna på plats samt begränsa vattenflöde förbi pluggen till dess att stamtunneln har fyllts och vattenmättats. De viktigaste egenskaperna för pluggens funktioner är dess vattentäthet och hållfasthet. Pluggen ska upprätthålla sina funktioner under KBS-3-förvarsanläggningens driftskeden. Den har ingen barriärfunktion i KBS-3-förvaret men får inte minska signifikant i volym eller innehålla material som kan påverka de tekniska barriärernas eller bergets barriärfunktioner.

Återfyllning och plugg ska också utformas så att de överensstämmer med konstruktionsförutsättningar från andra tekniska barriärer, och från produktion och drift av slutförvarsanläggningen. Med hänsyn till teknisk genomförbarhet ger återfyllning och plugg konstruktionsförutsättningar för deponeringstunnlar.

Återfyllningens referensutformning och dess överensstämmelse med konstruktionsförutsättningarna

Det referensmaterial som används för återfyllningen är bentonitlera med en nominell montmorillonithalt på 50–60 viktsprocent och en acceptabel variation mellan 45–90 %. Den installerade återfyllningen består av kompakterade block staplade på ett kompakterad plan bädd av bentonitpelletar. Spalten mellan blocken och bergytan är fylld med bentonitpelletar. För att uppnå en tillräcklig installerad densitet för det specificerade materialet består minst 60 % av tunnelvolymen av block.

Referensutformningens överensstämmelse med konstruktionsförutsättningarna har verifierats genom beräkningar och provning i laboratorium. Sambanden mellan densitet och hydraulisk konduktivitet, svälltryck respektive kompressibilitet har undersökts för alternativa material med den montmorillonithalt som specificerats för referensmaterialet. Slutsatsen är att bentonitleror med den specificerade montmorillonithalten överensstämmer med konstruktionsförutsättningarna.

Produktionen av återfyllningen

Metoderna för att tillverka återfyllningskomponenter och kontrollera deras egenskaper är baserade på etablerad teknik från liknande industriella tillämpningar. Referensmetoden för att tillverka block är enaxiell pressning och referensmetoden att tillverka pelletar är valskompaktering av små briketter. Bottenbädden installeras med en skruvmatare och kompakteras till ett plant lager. Blocken installeras lager för lager med ett lyftredskap och pelletarna sprutas in i utrymmet mellan blocken och bergytan.

Produktionen av återfyllningen omfattar huvuddelarna brytning och leverans, tillverkning av block och pelletar samt hantering och installation. Varje huvuddel är indelad i flera steg. Produktionskontroll scheman som beskriver de processer som genomförs för att förändra och/eller kontrollera återfyllningens utformningsparametrar i varje steg finns i rapporten.

Erfarenheter och resultat från genomförda materialleveranser, provtillverkning och -installation visar att material, återfyllningskomponenter och installerad återfyllning som ligger väl inom de acceptabla variationer som specificerats för referensutformningen kan åstadkommas. För att reducera variationen i blockens och pelletarnas densitet behöver tillverkningen anpassas till det valda materialet och också till materialleveranser.

Återfyllningens initialtillstånd

Återfyllningens initialtillstånd är tillståndet när hela deponeringstunneln är återfylld. Initialtillståndet kommer att bero av sammansättningen på återfyllningsmaterialet, densitet och mått på de installerade buffertkomponenterna, andelarna av tunneln fyllda med block och pelletar samt på deponeringstunnlarnas mått. För att beskriva återfyllningen vid initialtillståndet kombineras den materialsammansättning och de densiteter och mått på block och pelletar som kan förväntas baserat på nuvarande erfarenheter med erfarenheterna från att bygga deponeringstunnlar. Den installerade densiteten beräknas från den förväntade tunnelvolymen och resulterande block och pelletandelar.

Erfarenheterna visar att material med montmorillonithalt inom intervallet som specificerats för referensutformningen kan levereras och dess sammansättning kontrolleras med tillräcklig noggrannhet. Block och pelletar med acceptabel variation i mått och densitet kan tillverkas.

Den installerade densiteten beror huvudsakligen av den blockfyllda delen av deponeringstunnelns volym. Baserat på nuvarande erfarenheter blir den blockfyllda delen 67–79 % vilket ger en installerad densitet som, med marginal för materialförluster, är tillräcklig för att upprätthålla den konduktivitet, det svälltryck och den kompressibilitet som specificerats i konstruktionsförutsättningarna.

Pluggens referensutformning och dess överensstämmelse med konstruktionsförutsättningarna

Referenspluggen består av en betongplugg, en vattentät förslutning, ett filter, dräneringsrör och betongbalkar. Betongpluggen ska motstå deformationer och hålla den vattentäta förslutningen, filtret och återfyllningen på plats. Den vattentäta förslutningen består av bentonitblock och pelletar och ska täta läckagevägar och ta upp tryckgradienten över pluggen så att inga ogynnsamma tryck appliceras i gränssnittet mellan berget och betongen, och så att vattentrycket i den återfyllda tunneln jämnas ut. Filtret består av sand eller grus och ska samla upp vatten som sipprar ut från återfyllningen och, om det behövs, dränera det genom dränagerören tills betongpluggen har erhållit full hållfasthet. Betongbalkarna underlättar installationen.

Referenspluggens överensstämmelse med konstruktionsförutsättningarna ska verifieras för tre skeden i dess livslängd – härdningsskedet, tätningsskedet och skedet efter förslutning. Under härdningsskedet ska det verifieras att betongen härdar utan sprickbildning och att vatten kan dräneras förbi betongpluggen tills den uppnår full hållfasthet, om det behövs. Under tätningsskedet ska det verifieras att buffert- och återfyllningsmaterial förhindras från att passera förbi pluggen och att den motstår förekommande mekaniska laster utan signifikant deformation. För skedet efter förslutning ska det verifieras att pluggen inte påverkar de tekniska barriärernas eller bergets barriärfunktioner. De verifierande analyserna omfattar beräkningar och provning och visar att referenspluggen överensstämmer med konstruktionsförutsättningarna.

Produktionen av pluggen

Produktionen av pluggen är baserad på etablerad teknik från liknande tillämpningar och följer allmänt tillämpade rutiner. Med hänsyn till långsiktig säkerhet är det viktigt att material till pluggen är noga specificerade och att de kontrolleras vid leverans. Under härdningsfasen är det viktigt att installationen genomförs enligt specifikationer och att betongens temperatur regleras. För att begränsa transport av buffert- och återfyllningsmaterial ut från deponeringstunneln är det viktigt att pluggen installeras utan avbrott direkt efter installationen av återfyllningen är klar.

Pluggens initialtillstånd

I slutförvaret kan pluggarna betraktas som konstruktionsmaterial som lämnats kvar i förvaret. Pluggen innehåller inte material som kan påverka de tekniska barriärernas eller bergets barriärfunktioner, och den kommer att uppta volymen mellan återfyllningen och förslutningen i stamtunneln.

Contents

1	Introduction	17
1.1	General basis	17
1.1.1	This report	17
1.1.2	The design of the backfill and plug	17
1.1.3	The production of the backfill and plug	18
1.2	Purpose, objectives and delimitations	18
1.2.1	Purpose	18
1.2.2	Objectives	18
1.2.3	Limitations	18
1.3	Interfaces to other reports included in the safety report	19
1.3.1	The safety report for the long-term safety	19
1.3.2	The safety report for the operational safety	19
1.3.3	The other production reports	19
1.4	Structure and content	20
1.4.1	Overview	20
1.4.2	Design premises	20
1.4.3	Reference design	20
1.4.4	Conformity of the reference design to the design premises	20
1.4.5	Production of the backfill and plug	20
1.4.6	Initial state of the backfill and plug	21
2	Design premises for the backfill and plug	23
2.1	General basis	23
2.1.1	Identification and documentation of design premises	23
2.1.2	Definition, purpose and basic design of the backfill	23
2.1.3	Defintion, purpose and basic design of the plug	24
2.2	Barrier functions and design considerations	24
2.2.1	Barrier functions of the backfill in the KBS-3 repository	24
2.2.2	Functions and properties of the plug in the KBS-3 repository and repository facility	24
2.2.3	Design considerations	25
2.3	Design premises for the backfill	25
2.3.1	Design premises related to the barrier functions in the KBS-3 repository	26
2.3.2	Design premises from the other engineered barriers	26
2.3.3	Design premises related to the production and operation	27
2.4	Design premises imposed by the backfill	27
2.4.1	Deposition tunnels	27
2.4.2	Plug in deposition tunnels	28
2.5	Design premises for the plug	29
2.5.1	Design premises related to properties of the plug in the KBS-3 repository	29
2.5.2	Design premises from the engineered barriers	30
2.5.3	Design premises related to the production	30
2.6	Design premises imposed by the plug	30
2.6.1	Deposition tunnels	30
3	Reference design of the backfill	33
3.1	Backfill material and components	33
3.1.1	Material composition	33
3.1.2	Material ready for compaction	34
3.1.3	Blocks and pellets	35
3.2	Installed backfill	36
4	Conformity of the reference backfill to the design premises	39
4.1	Hydraulic conductivity and swelling pressure	39

4.2	Compressibility and restriction of buffer swelling/expansion	41
4.3	Substances that may cause harmful buffer degradation or canister corrosion	43
4.4	Maintain the barrier functions	43
4.5	Design premises from production and operation	44
4.5.1	Compactability of the backfill material	44
4.5.2	Geometrical configuration and design of blocks, pellets and bottom bed pellets	45
4.6	Summary of results and conclusions	45
4.6.1	Hydraulic conductivity and swelling pressure	45
4.6.2	Compressibility restricting buffer swelling/expansion	46
4.6.3	Substances that may cause harmful buffer degradation or canister corrosion	46
4.6.4	Maintain barrier functions	46
5	Production of the backfill	47
5.1	Overview	47
5.1.1	Design premises for the development of methods for the production	47
5.1.2	The production line for the backfill	47
5.1.3	Reference methods for manufacturing and installation	47
5.1.4	Reference strategy and methods for test and inspection	50
5.1.5	The design parameters and process schemes	50
5.2	Excavation and delivery	54
5.2.1	Excavation and delivery for shipment	54
5.2.2	Material delivery and intermediate storage in harbour	54
5.2.3	Transport to and storage at the production plant	55
5.2.4	Methods for test and inspection of material composition	55
5.2.5	Methods for test and inspection of granule size distribution and water content	56
5.2.6	Experiences and results	56
5.3	Manufacturing of blocks, pellets and bottom bed	56
5.3.1	Conditioning of the backfill material	56
5.3.2	Pressing of blocks	58
5.3.3	Pressing of pellets	59
5.3.4	Methods for test and inspection of material composition	60
5.3.5	Methods for test and inspection of granule size distribution and water content	60
5.3.6	Methods for test and inspection of weight, dimensions and density	60
5.3.7	Experiences and results	61
5.4	Handling and installation	62
5.4.1	Intermediate storage at ground level	62
5.4.2	Transport to and storage at repository level	63
5.4.3	Preparation of deposition tunnel	64
5.4.4	Installation of backfill in rejected deposition holes	64
5.4.5	Installation of backfill in the upper part of the deposition hole	64
5.4.6	Installation of bottom bed	65
5.4.7	Installation of blocks	66
5.4.8	Installation of pellets	66
5.4.9	Methods for inspection of weight, dimensions and density of blocks and pellets	67
5.4.10	Methods for inspection of installed density	67
5.4.11	Experiences and results	68
6	Initial state of the backfill	71
6.1	Initial state and conformity to the reference design	71
6.1.1	Initial state	71
6.1.2	Material composition	72
6.1.3	Blocks and pellets	72
6.1.4	Installed backfill density	73
6.2	Conformity to design premises long-term safety at the initial state	76
6.2.1	Hydraulic conductivity and swelling pressure	76

6.2.2	Compressibility restriction buffer swelling/expansion	76
6.2.3	Substances that may cause harmful buffer degradation or canister corrosion	76
6.2.4	Maintain barrier functions	76
7	Reference design of the plug	77
7.1	The parts of the plug and their functions	77
7.2	The installed plug and its material and components	78
7.2.1	Concrete plug	79
7.2.2	Watertight seal	80
7.2.3	Filter	80
7.2.4	Prefabricated components	80
8	Conformity of the reference plug to the design premises	81
8.1	The curing phase	81
8.1.1	Concrete plug	81
8.1.2	Filter	82
8.2	The sealing phase	82
8.2.1	Concrete plug	82
8.2.2	Watertight seal	82
8.3	The post closure phase	82
9	Production of the plug	85
9.1	Overview	85
9.1.1	Design premises for the production of the plug	85
9.1.2	The production of the plug	86
9.1.3	Reference methods for construction and inspections	87
9.1.4	Key stages in the production of the plug	87
9.2	Ordering, delivery and storage	88
9.2.1	Overview of processes and inspections	88
9.2.2	Issues of importance for the resulting properties of the plug	88
9.3	Manufacturing and preparation of components	88
9.3.1	Overview of processes and inspections	88
9.3.2	Issues of importance for the resulting properties of the plug	89
9.4	Installation of all parts except concrete plug	89
9.4.1	Overview of processes and inspections	89
9.4.2	Issues of importance for the resulting properties of the plug	89
9.5	Installation of the concrete plug	89
9.5.1	Overview of processes and inspections	89
9.5.2	Issues of importance for the resulting properties of the plug	90
10	Initial state of the plug	91
10.1	Initial state of the plug and its conformity to the reference design	91
10.2	Functions of the plug during the sealing phase	92
11	References	93
Appendix A	Definitions used for describing clay material	95
Appendix B	Initial state of the variables used for the long term evolution of the backfill	97
Appendix C	Glossary of abbreviations and branch terms	99

1 Introduction

1.1 General basis

1.1.1 This report

This report presents the reference design, production and initial state of the backfill and plug in deposition tunnels in the KBS-3 repository for spent nuclear fuel. It is included in a set of reports presenting how the KBS-3 repository is designed, produced and inspected. The set of reports is denominated *Production reports*. The Production reports and their short names used as references within the set are illustrated in Figure 1-1. The reports within the set referred to in this report and their full names are presented in Table 1-1.

This report is part of the safety report for the KBS-3 repository and repository facility, see **Repository production report**, Section 1.2. It is based on the results and review of the most recent long-term safety assessment the current knowledge, technology and results from research and development.

1.1.2 The design of the backfill and plug

The presented design of the backfill and plug in the deposition tunnels presumes a repository based on the KBS-3 method with vertical deposition of canisters in individual deposition holes as further described in Chapter 3 in the **Repository production report**.

The reference design of the backfill and plug and the reference methods to produce them presented in this report constitute solutions that are technically feasible. It is, however, foreseen that the design premises, the design as well as the presented methods for production, test and inspection will be further developed and optimised before the actual construction of the KBS-3 repository facility commences.

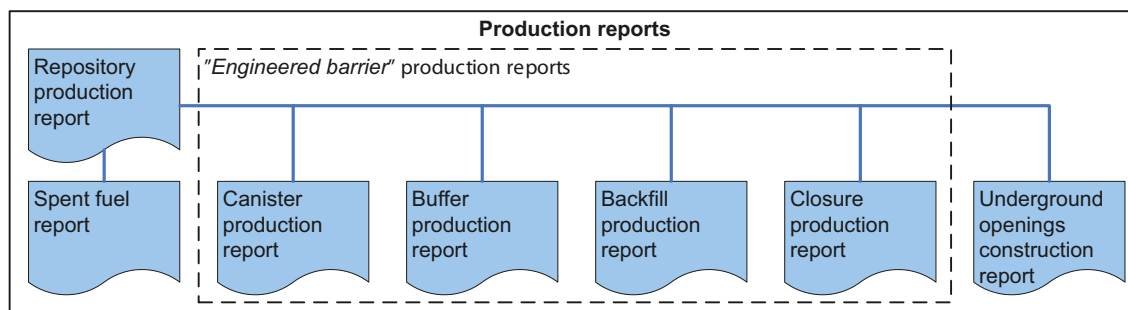

Figure 1-1. The reports included in the set of reports describing how the KBS-3 repository is designed, produced and inspected.

Table 1-1. The reports within the set of Production reports referred to in this report.

Full title	Short name used within the Production reports	Text in reference lists
Design and production of the KBS-3 repository	Repository production report	Repository production report, 2010. Design and production of the KBS-3 repository. SKB TR-10-12, Svensk Kärnbränslehantering AB.
Design, construction and initial state of the underground openings	Underground openings construction report	Underground openings construction report, 2010. Design, construction and initial state of the underground openings. SKB TR-10-18, Svensk Kärnbränslehantering AB.

This particularly concerns properties of the backfill and plug that require detailed information on the conditions at repository depth. In this context it should be mentioned that there are alternative designs that conform to the design premises as well as there are alternative ways to produce the reference design. In addition, the safety assessment SR-Site, as well as future safety assessments, may result in up-dated design premises. SKB's objective is to continuously develop and improve both design and production and adapt them to the conditions at the selected site.

1.1.3 The production of the backfill and plug

The presented production of the backfill and plug in deposition tunnels is based on that there is a system, the KBS-3 system comprising the facilities required to manage the spent nuclear fuel and finally deposit it in a KBS-3 repository. The KBS-3 system and its facilities etc are presented in Chapter 4 in the **Repository production report**.

The presented handling and installation of the backfill and plug are included in the deposition works in the KBS-3 repository facility. They are based on the backfill sequence presented in Section 4.1.4 in the **Repository production report**.

1.2 Purpose, objectives and delimitations

1.2.1 Purpose

The purpose of this report is to describe how the backfill and plug in deposition tunnels are designed, produced and inspected in a manner related to their importance for the safety of the KBS-3 repository. The report shall provide the information on the design, production and initial state of the backfill and plug in deposition tunnels required for the long-term safety report, **SR-Site**, as well as the information on how to produce and inspect them required for the operational safety report, **SR-Operation**.

With this report SKB intends to present the design premises for the backfill and plug in deposition tunnels and demonstrate how they can be designed, produced and inspected to conform to the stated design premises. The report shall present the reference designs and production methods and summarise the research and development efforts that supports that the backfill and plug can be produced in conformity to the design premises.

1.2.2 Objectives

Based on the above purpose the objectives of this report are to present:

- the design premises for the backfill and plug,
- the reference design of the backfill and plug,
- the conformity of the reference design to the design premises,
- the planned production,
- the initial state of the backfill and plug, i.e. the expected result of the production comprising as built data on the properties taken credit for as contributing to, or affecting, the barrier functions and safety.

1.2.3 Limitations

The **Backfill production report** primarily includes design premises related to the long-term safety of the KBS-3 repository. The presented reference designs must conform to these design premises and consequently they have in most cases determined the design. Design premises related to other aspects than safety and radiation protection are only included if they have determined the design of the backfill and plug or the methods to produce them.

The **Backfill production report** also includes the design considerations taken with respect to the application of best available technique with regard to safety and radiation protection. It includes the related design premises for the design and development of methods to produce them. Motivations for the presented reference designs and methods as the best available are presented elsewhere.

1.3 Interfaces to other reports included in the safety report

The role of the Production reports in the safety report is presented in Section 1.2 in the **Repository production report**. A summary of the interfaces to other reports included in the safety report is given below.

1.3.1 The safety report for the long-term safety

By providing a basic understanding of the repository performance on different time-periods and by the identification of scenarios that can be shown to be especially important from the standpoint of risk the long-term safety assessment provide feedback to the design of the engineered barriers and underground openings. The methodology used for deriving design premises from the long-term safety assessment is introduced in the **Repository production report**, Section 2.5.2. A more thorough description as well as the resulting design premises are given in the report “Design premises for a KBS-3V repository based on results from the safety assessment SR-Can and some subsequent analyses” /SKB 2009/, hereinafter referred to as **Design premises long-term safety**. These design premises constitute a basic input to the design of the backfill and plug in deposition tunnels.

As stated in Section 1.2 this report shall provide information on the initial state of the backfill and plug in the deposition tunnels for the long-term safety assessment. This report shall also provide data concerning the design of the backfill and plug, and the initial state used in the calculations included in the long-term safety assessment.

1.3.2 The safety report for the operational safety

The objectives for the operational safety and radiation protection in the KBS-3 repository facility and the general description of the facility and its main activities given in Chapters 3 and 5 in **SR-Operation** constitute input to this report.

This report provides information to **SR-Operation** on the design of the backfill and plug and the technical systems used to manufacture, handle, install, test and inspect them as well as instructions on where and when inspections shall be performed.

1.3.3 The other production reports

The **Repository production report** presents the context of the set of Production reports and their role within the safety report. It also includes definitions of some central concepts of importance for the understanding of the Production reports.

The **Repository production report** sets out the laws and regulations and demands from the nuclear power plant owners applicable to the design of a final repository for spent nuclear fuel. In addition, it describes the functions of a KBS-3 repository and how safety is provided by the barriers and their barrier functions. The report goes on to describe how design premises are derived from laws and regulations, owner demands and the iterative processes of design and safety assessment and design and technique development respectively. The starting point for the design premises presented in this report is the barrier functions and design considerations introduced in the **Repository production report**, Chapter 3.

The design and production of the different engineered barriers and underground openings are inter-related. An overview of the design and production interfaces, including the integrated process of buffer and backfill installation is provided in the **Repository production report**, Chapter 4.

The design premises imposed by the backfill and plug on the design and production of the other engineered barriers and underground openings are presented in this report. These design premises are repeated and verified in the production reports for the engineered barriers and underground openings on which the backfill and plug impose design premises.

1.4 Structure and content

1.4.1 Overview

The general flow of information in the **Backfill production report** can be described as follows:

- design premises,
- reference design,
- conformity of the reference design to the design premises,
- production,
- initial state.

The listed bullets are further described in the following sections. In addition, the context of the report is presented in this chapter and in Appendix C abbreviations and branch terms used in this report are explained.

1.4.2 Design premises

The design premises set out the information required for the design. The design premises for the backfill and plug in deposition tunnels are presented in Chapter 2 of this report. The chapter is initiated with the definition of the backfill and plug, their purpose and basic design. After that follows a presentation of the barrier functions the backfill shall provide, and the functions the plug shall provide to contribute to the safety of the final repository and the considerations that shall be made in the design with respect to the application of a well-tried and reliable technique. Finally, the detailed design premises for the backfill and plug are given. They state the properties the reference design shall have to maintain the functions and to conform to the design considerations.

1.4.3 Reference design

The descriptions of the reference designs comprises the backfill and plug material and components and the installed backfill and plug. The reference design of the backfill is presented in Chapter 3 and the reference design of the plug is presented in Chapter 7. The reference designs are specified by a set of variables denominated *design parameters*, e.g. montmorillonite content and block bulk density. The design parameters shall be inspected in the production and acceptable values for them are given for the reference designs. The design premises and considerations that have determined the design parameters are presented.

1.4.4 Conformity of the reference design to the design premises

An important part of this report is the analyses verifying the conformity of the reference designs to the design premises. The conformity to each of the design premises given as feedback from the long-term safety assessment as well as the design premises related to technical feasibility, production and operation is analysed and concluded. The conformity of the reference backfill and plug to the design premises are presented in Chapters 4 and 8 respectively.

1.4.5 Production of the backfill and plug

The presentation of the production of the backfill and plug is initiated by an overview comprising:

- requirements on the production and design premises for the development of methods to produce, test and inspect the backfill and plug,

- illustration of the main parts and different stages of the production,
- short descriptions of the reference methods for production, test and inspection,
- overview over the design parameters and the corresponding parameters measured in the production to inspect them, and in which stage of the production the design parameters are determined, affected and inspected.

After that follows descriptions of each stage in the production of the backfill and how the design parameters are affected, tested and inspected within each stage. The current experiences and results from each main part of the production are summarised. The production of the backfill is described in Chapter 5. For the plug an overview of the key issues to be considered in the production is provided in Chapter 9.

1.4.6 Initial state of the backfill and plug

In Chapters 6 and 10, the initial state chapters, for the backfill and plug respectively, the expected values of the design parameters, and other parameters required for the assessment of the long-term safety, at the initial state are presented. The expected values are based on the current experiences from the production trials, and they are discussed and justified with respect to the currently available results presented in the production chapter. Finally, the conformity of the backfill at the initial state to the design premises stated in **Design premises long-term safety** is summarised.

2 Design premises for the backfill and plug

In this chapter the design premises for the backfill and plug are presented. They comprise the functions and properties the backfill and plug shall sustain in the KBS-3 repository and the premises for their design. *The required functions and design premises are written in italics.*

2.1 General basis

2.1.1 Identification and documentation of design premises

The methodology to derive, review and document design premises is presented in the **Repository production report**, Chapter 2. The design premises are based on:

- international treaties, national laws and regulations,
- the functions of the KBS-3 repository,
- the safety assessment,
- technical feasibility,
- the planned production.

The **Repository production report**, Section 2.2 includes a presentation of the laws and regulations applicable for the design of a final repository for spent nuclear fuel. Based on the treaties, laws and regulations SKB has substantiated functions and considerations as a specification of the KBS-3 repository, and as guidelines for the design of its engineered barriers and underground openings. In Sections 3.5.2 and 3.8.2 of the **Repository production report** the functions and properties the backfill and plug shall sustain in order to contribute to the functions of the KBS-3 repository are presented. Section 3.9 of the **Repository production report** introduces the design considerations to be applied in the design work. The presented barrier functions of the backfill, the functions of the plug and the considerations that shall be applied in the design work are repeated in Section 2.2 in this report.

The design premises related to the functions of the backfill in the KBS-3 repository are based on the results from the latest performed long-term safety assessment and some subsequent analyses. These design premises for the backfill are provided in **Design premises long-term safety**, and are presented in Section 2.3.1 in this report. Corresponding design premises for the plug are presented in Section 2.5.1.

Design premises related to technical feasibility refer to the properties the backfill and plug shall have to fit, and work, together with the engineered barriers and other parts of the final repository during the production. The general approach to substantiate this kind of design premises is presented in Section 2.5.1 in the **Repository production report**. The interfaces to the engineered barriers and other parts in the production are summarised in Sections 4.6.2 and 4.8.2 in the **Repository production report** for the backfill and plug, respectively. In this report, these design premises are presented in Section 2.3.2 for the backfill and in Section 2.5.2 for the plug. In Sections 2.4 and 2.6 the design premises the backfill and plug impose on other parts of the KBS-3 repository are presented.

Finally, design premises related to the operation of the KBS 3 repository facility and the production of the backfill and plug are presented in Sections 2.3.3 and 2.5.3 in this report for the backfill and plug respectively. The methodology to substantiate these kinds of design premises is presented in Section 2.5.4 in the **Repository production report**.

2.1.2 Definition, purpose and basic design of the backfill

The backfill is one of the engineered barriers in the KBS-3 repository. The backfill is the material installed in deposition tunnels to fill them. The purpose and function of the backfill in deposition tunnels is to sustain the multi-barrier principle by keeping the buffer in place and restrict groundwater flow through the deposition tunnels.

The design premises for the backfill are based on that it consists of compacted bentonite clay blocks and pellets to be installed in the deposition tunnel.

2.1.3 Definition, purpose and basic design of the plug

The plug in deposition tunnels has no barrier function in the KBS-3 repository. The plug in deposition tunnels is the construction closing deposition tunnels during the operational phases. The plug shall close the deposition tunnels, keep the backfill in them in place and prevent water flow past the plug until the main tunnel has been filled and saturated.

The design premises for the plug are based on that it consists of a concrete plug, a watertight seal and a filter.

2.2 Barrier functions and design considerations

In this section barrier functions of the backfill, functions of the plug and design considerations for the backfill and plug are presented. They are based on the functions of the final repository presented in Section 3.1.2 in the **Repository production report** and have been divided into:

- barrier functions and properties that the backfill must retain in order for the final repository to maintain its safety (Section 2.2.1),
- functions and properties the plug shall sustain (Section 2.2.2),
- issues that shall be considered when developing a backfill and plug design and methods for its manufacturing, preparation, installation, test and inspection (Section 2.2.3).

2.2.1 Barrier functions of the backfill in the KBS-3 repository

In order for the KBS-3 repository to maintain the multi-barrier principle and have several barriers that individually and together contribute to maintain the barrier functions the backfill shall:

- *limit flow of water (advective transport) in deposition tunnels,*
- *restrict upwards buffer swelling/expansion,*
- *not significantly impair the barrier functions of the other barriers.*

For the final repository to provide protection from harmful effects of radiation as long as required regarding the radiotoxicity of the spent nuclear fuel, and to withstand events and processes that can affect the barrier system the backfill shall:

- *be long-term durable and maintain its barrier functions in the environment expected in the final repository.*

2.2.2 Functions and properties of the plug in the KBS-3 repository and repository facility

In order for the barrier system of the final repository to withstand conditions, events and processes that may impact its functions, the plug shall:

- *withstand the hydrostatic pressure at repository depth and the swelling pressure of the backfill until the main tunnel is filled,*
- *limit water flow past the plug until adjacent main tunnel is filled and saturated,*
- *be durable and maintain its functions in the environment expected in the repository facility and repository until the closure in the main tunnel is saturated.*

In the long-term perspective in the final repository, in order for the repository to maintain the multi-barrier principle, the plugs must:

- *not significantly impair the barrier functions of the engineered barriers or rock.*

These functions and properties shall be secured and maintained during different periods of the lifetime of the plug, see further Section 2.5.

2.2.3 Design considerations

In this section the design considerations that shall be regarded in the design of the backfill and plug and in the development of methods to manufacture, install, test and inspect them and their components are presented. The design considerations mainly affect the development of methods. When a reference design is determined it together with the design considerations form the basis for the detailed design premises for the development of methods to manufacture, install, test and inspect the backfill and plug presented in Sections 5.1.1 and 9.1.1 respectively.

The barrier system of the final repository shall withstand failures and conditions, events and processes that may impact their functions. Hence the following shall be considered in the development of a backfill and plug concept.

- *The design and methods for preparation, installation, test and inspection shall be based on well-tried or tested technique.*

The construction, manufacturing, installation and non-destructive tests of the barriers of the final repository to be dependable, and the following shall be considered.

- *Backfill and plug with specified properties shall be possible to prepare and install with high reliability.*
- *The properties of the backfill and plug shall be possible to test and inspect against specified acceptance criteria.*

A reliable production is also required with respect to SKB's objective to achieve high quality and cost-effectiveness. Regarding cost-effectiveness the following shall be considered.

- *The designs of the backfill and plug and methods for preparation, installation, test and inspection shall be cost-effective.*
- *Backfill and plug installation shall be possible to perform in the prescribed rate.*

Further, environmental impact such as noise and vibrations, emissions to air and water and consumption of material and energy shall be considered in the design. Methods to prepare and install the backfill and plug must also conform to regulations for occupational safety. Design premises related to these aspects can generally be met in alternative ways for backfill and plug designs that conform to the safety and radiation protection design premises. Together with design premises related to efficiency and flexibility they are of importance for the design of technical systems and equipment used in the production of the backfill and plug. The design of the technical equipment is not discussed in this report.

2.3 Design premises for the backfill

In this section the design premises for the backfill are given. They constitute a specification for the design of the backfill. The design premises comprise the properties and parameters to be designed and premises for the design such as quantitative information on features, performance, events, loads, stresses, combinations of loads and stresses and other information, e.g. regarding environment or adjacent systems, which form a necessary basis for the design.

The design premises are based on the barrier functions presented in Section 2.2.1 and the design considerations presented in Section 2.2.3. They are also based on, and constitute a concise summary of, the current results of the design process with its design-safety assessment and design-technical feasibility iterations, see Section 2.5.1 in the **Repository production report**.

The design premises given as feedback from the long-term safety assessment are compiled in **Design premises long-term safety**.

The design premises given as feedback from the technical development are based on the reference designs of the other parts of the KBS-3 repository and the construction, deposition and backfill sequence presented in Section 4.1.4 in the **Repository production report**.

2.3.1 Design premises related to the barrier functions in the KBS-3 repository

The design premises related to the barrier functions in the KBS-3 repository are compiled in Table 2-1. In the leftmost column of the table the barrier functions which form the basis for the design premises and that were presented in Section 2.2.1 are repeated, the middle column contains the backfill properties and design parameters to be designed and in the rightmost column the design premises as stated in **Design premises long-term safety** are given.

The design premises presented in Table 2-1 are based on the presumption that the buffer, deposition holes and tunnels are constructed according to their reference design and comply with the design premises given for them.

2.3.2 Design premises from the other engineered barriers

Design premises for the backfill imposed by the other engineered barriers refer to technical feasibility. There are no design premises related to technical feasibility imposed on the backfill by the other barriers.

Table 2-1. Barrier functions, properties to be designed and design premises for the backfill.

Barrier function or property	Property and design parameters to be designed	Design premises long-term safety
<i>The backfill shall limit flow of water (advective transport) in deposition tunnels.</i>	Properties that affect swelling pressure and hydraulic conductivity of the saturated backfill. Material composition – <i>montmorillonite content</i> . Installed density – <i>dry density and water content of blocks, pellet filling and bottom bed; portions of the deposition tunnel filled with blocks, pellet filling and bottom bed</i> .	Hydraulic conductivity < 10 ⁻¹⁰ m/s. Swelling pressure > 0.1 MPa.
<i>The backfill shall restrict upwards buffer swelling/expansion.</i>	Properties that affect the compactability of the un-wetted and saturated backfill. Material composition – <i>montmorillonite content</i> . Installed density – <i>dry density and water content of blocks, pellet filling and bottom bed; portions of the deposition tunnel filled with blocks or pellets</i> .	<i>Packing and density of the backfill, both at initial dry state and after complete water saturation must be sufficient to ensure a compressibility that results in a minimum buffer saturated density according to the conditions set out (i.e. 1,950 kg/m³) with sufficient margin to loss of backfill and uncertainties.</i>
<i>The backfill must not significantly impair the barrier functions of the other barriers.</i>	Properties that affect the chemical conditions around the buffer and canister. Material composition.	–
<i>The backfill shall be long-term durable and maintain its barrier functions in the environment expected in the final repository.</i>	Properties that affect swelling pressure and hydraulic conductivity of the saturated backfill and compactability of the un-wetted and saturated backfill. Material composition – <i>montmorillonite content</i> . Installed density – <i>dry density and water content of blocks, pellet filling and bottom bed; portions of the deposition tunnel filled with blocks, pellet filling and bottom bed</i> .	–

2.3.3 Design premises related to the production and operation

In this section the design premises for the backfill and its components related to their production and the operation of the KBS-3 repository facility are given. (Design premises for the methods to manufacture, install, test and inspect the components are given in Section 5.1.1). In addition to the design considerations presented in Section 2.2.3, they are based on the current reference sequence for deposition of the canister and installation of the buffer and backfill presented in the **Repository production report**, Section 4.1.4.

The design premises related to the production and operation are presented in Table 2-2. In the leftmost column the design considerations from Section 2.2.3 are repeated.

2.4 Design premises imposed by the backfill

In this section the design premises imposed by the backfill on the other engineered barriers and the underground openings in order to achieve a technically feasible design and reliable production are presented. The backfill provides design premises for the deposition tunnels and plugs in deposition tunnels, they are further discussed and verified in the **Underground openings construction report** and in the chapters about the plug in this report.

2.4.1 Deposition tunnels

In order for the backfill to maintain its barrier functions the backfill density shall be high enough throughout the deposition tunnel cross section and length. Further it must be possible to install the backfill material to the required density in the deposition tunnel. To achieve the required density the variation in tunnel geometry must be limited and known.

The design considerations stating that: backfill with specified properties shall be possible to install with high reliability and that it shall be based on well-tried or tested technique, together with the current results of the development of the backfill concept and methods for excavation determines the deposition tunnel properties and design parameters to be designed and the related design premises presented in Table 2-3.

The design of the deposition tunnel and backfill is the result of an iterative design process with the objective to establish a solution where the deposition tunnels can be constructed and the required backfill density can be achieved with high reliability and so that mishaps in connection to the backfill installation are prevented. Since the deposition tunnel geometry must be known to determine a backfill design and since the backfill is an engineered barrier in the KBS-3 repository the required geometry of the deposition tunnel is stated as a design premise from the backfill on the deposition tunnel, and not vice versa.

Table 2-2. Design premises for the backfill related to the production and operation.

Design consideration	Required property	Design premises
<i>The design and methods for preparation, installation, test and inspection shall be based on well-tried or tested technique.</i>	<i>The backfill material must be possible to compact to required density.</i>	–
<i>Backfill with specified properties shall be possible to prepare and install with high reliability.</i>	<i>The backfill components shall be designed so that installation can be performed with high reliability.</i>	<i>The reference sequence for deposition of the canister and installation of the buffer and backfill. The reference design of the deposition tunnels.</i>
	<i>The combination of the geometrical configuration of the backfill material and the installation technique shall be such that the seepage into the deposition tunnels and the resulting hydraulic processes that take place during installation do not impair the barrier functions of the backfill.</i>	<i>The backfill shall yield the required properties given the accepted inflow imposed on the deposition tunnels (see Table 2-3).</i>

The design premises imposed on the deposition tunnels by the backfill are given in Table 2-3. They comprise acceptable inflow to the deposition tunnels and acceptable dimensions and geometry. The acceptable dimensions and geometry of the deposition tunnels are illustrated in Figure 2-1. They are based on the current experiences and will be developed.

2.4.2 Plug in deposition tunnels

The plugs are especially designed with respect to the properties and function of the buffer and backfill. The design premises for the plug imposed by the buffer and backfill are presented in Section 2.5.2.

Table 2-3. Design premises imposed on the deposition tunnels by the backfill.

Required property	Design premises
<i>The deviations of floor and wall surfaces in deposition tunnels from the nominal must be limited in order to allow backfilling according to specification.</i>	<p><i>For each blast round the total volume between the rock wall contour and the nominal contour of the deposition tunnel shall be less than 30% of the nominal tunnel volume.</i></p> <p><i>The maximum cross section shall be less than 35% larger than the nominal cross section.</i></p> <p><i>To achieve a dependable backfill installation the tunnel floor must be even enough for the backfill installation equipment to drive on it.</i></p> <p><i>Underbreak is not accepted.</i></p> <p><i>See Figure 2-1.</i></p>
<i>The floor and wall surfaces in deposition tunnels shall for the most part consist of rock surface so that the backfill will be in direct contact with the rock.</i>	<p><i>Limited areas may be covered with construction materials. The areas must not extend over the full tunnel width.</i></p>
<i>The seepage into deposition tunnels during backfill installation and saturation must not significantly impair the backfill barrier functions.</i>	<p><i>Based on current experiences the maximum distributed inflow to the deposition tunnel is set to be less than or equal to 1.7 l/min 100 m (based on 5 l/min in a 300 m long deposition tunnel) and the maximum point inflow less than or equal to 0.1 l/min /Sandén et al. 2008, Dixon et al. 2008a, Dixon et al. 2008b/.</i></p>

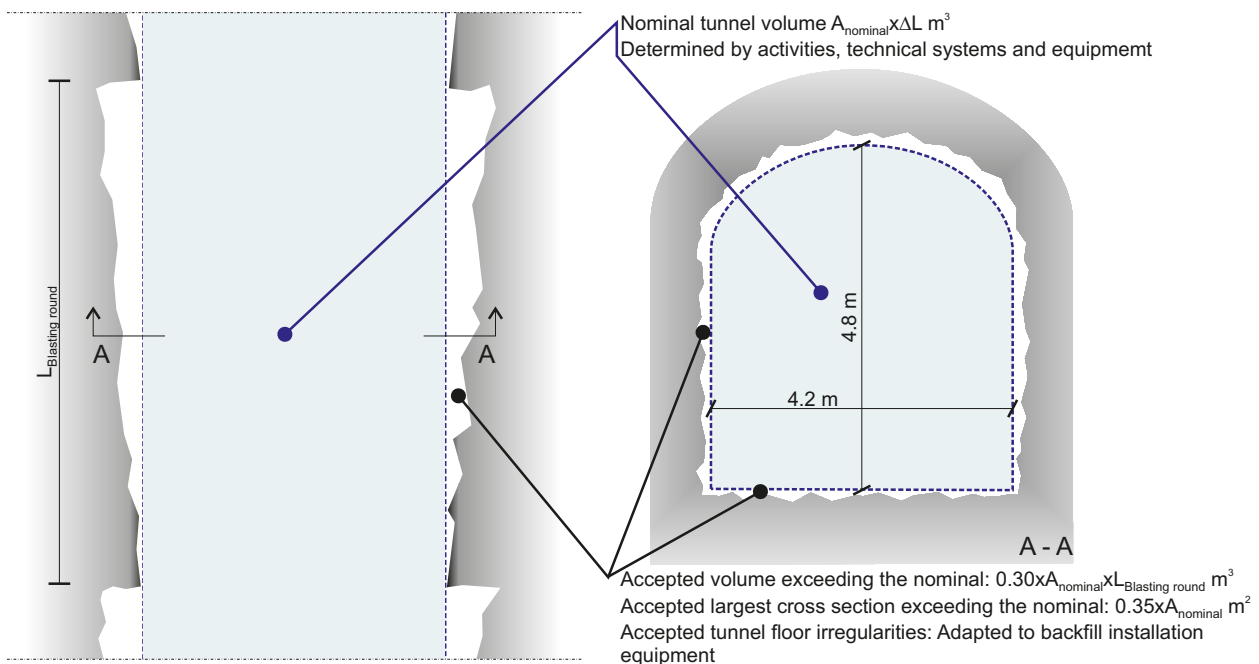

Figure 2-1. Nominal tunnel geometry and acceptable volume of rock fall out and irregularities in the tunnel floor. These constitute the design premises for deposition tunnels as presented in the Underground openings construction report.

2.5 Design premises for the plug

In this section the design premises for the plug are given. They constitute a specification for the design of the plug. The design premises comprise the properties and parameters to be designed and premises for the design such as quantitative information on features, performance, events, loads, stresses, combinations of loads and stresses and other information, e.g. regarding environment or adjacent systems, which form a necessary basis for the design.

The design premises are based on the functions and properties presented in Section 2.2.2 and the design considerations presented in Section 2.2.3. They are also based on, and constitute a concise summary of, the current results of the design process with its design-technical feasibility iterations, see Section 2.5.1 in the **Repository production report**.

The design premises given as feedback from the technical development are based on the reference designs of the other parts of the KBS-3 repository and the construction, deposition and backfill sequence presented in Section 4.1.4 in the **Repository production report**.

Important for the design of the plug is also the division of its lifetime into three phases:

- the curing phase,
- the sealing phase,
- the post closure phase.

The curing phase comprises the curing until the plug has gained full strength, and is regarded as part of the production of the plug. Design premises related to this phase and are presented in Section 2.5.3.

The sealing phase refers to the period from full strength is gained until the adjacent main tunnel is filled and saturated. During the sealing phase the plug shall maintain its functions to withstand occurring pressures and limit water transport out from the backfilled tunnels. The design premises related to these functions are set by the buffer and backfill and are presented in Section 2.5.2 Design premises from the engineered barriers.

The post closure phase, ultimately, is the phase after closure when the plug is left in the final repository. Design premises related to this phase are presented in Section 2.5.1.

2.5.1 Design premises related to properties of the plug in the KBS-3 repository

In the final repository during the post closure phase the plug must not significantly impair the barrier functions of the engineered barriers or rock. The design premises related to this function are presented in Table 2-4.

Table 2-4. Design premises for the plug related to its properties in the final repository during the post closure phase.

Function or property	Property and design parameters to be designed	Design premises
<i>The plug must not significantly impair the barrier functions of the engineered barriers or rock.</i>	Volume and compressibility of the plug (all parts)	<i>The decrease in volume must not cause loss in backfill density that significantly reduce its barrier functions.</i>
	Concrete plug material composition Concrete recipe: <i>composition of binder and additional ingredients</i>	<i>Low pH concrete shall be used. The leachates from the concrete must have a pH ≤ 11. The amount of organic materials shall be limited. Organic superplasticizer, but no other organic components, are accepted.</i>

2.5.2 Design premises from the engineered barriers

In this section design premises from the engineered barriers on the plug are given.

Buffer and backfill

The plugs in deposition tunnels are important for the properties and function of the buffer and backfill. The plug shall provide a physical restraint to material transport and keep the backfill in place during its saturation and homogenisation when the pressure in the deposition tunnels is equalised. The design premises related to the functions the plug shall maintain during the sealing phase are presented in Table 2-5.

While the deposition tunnels are open there is a water inflow from the rock, the water is drained out to the main tunnel. When the backfilling commences the pellet filling is expected to capture the inflowing water. However, clay may be transported out from the deposition tunnel as long as there are:

- open channels in the backfill or buffer,
- a pressure gradient resulting in a water movement sufficient to erode clay particles,
- a downstream location for removal of eroded material.

When the clay is saturated a swelling pressure will build up and seal the open channels. However, as long as the pressure in the open channels is low and the pressure in the fractures in the rock is high the water will flow along the channels and the bentonite can not seal them. It is therefore important to stop the potential water outflow from the deposition tunnel as soon as possible and to equalise the pressure difference between the fractures in the rock and the open channels. If a tight plug is installed in the end of the deposition tunnel the volume of water that can transport clay will not be larger than the air void volume in the deposition holes and deposition tunnel. Every litre of water that passes the plug or end of the deposition tunnel will add to this volume. When a tight plug is installed and the same pressure prevails everywhere in the deposition tunnel the channels can be sealed by the swelling clay. The plug must also prevent backfill expansion/swelling out from the deposition tunnel.

When the main tunnel is filled it will provide a counter pressure for backfill expansion/swelling, and when it is saturated there is no longer a flow potential for material transport over the plug and out from the deposition tunnel. The plug has then fulfilled its sealing functions.

2.5.3 Design premises related to the production

In this section the design premises related to the production of the plug are given. They are valid during the curing phase. In Table 2-6 design premises for the plug related to its construction are given while the design premises for the construction and construction methods are presented in Section 9.1.1.

2.6 Design premises imposed by the plug

In this section the design premises imposed by the plug on the engineered barriers and the underground openings in order to achieve a technically feasible design and reliable production are presented. The plug provides design premises for the deposition tunnels, they are further discussed and verified in the **Underground openings construction report**.

2.6.1 Deposition tunnels

The design premises imposed by the plug on the underground openings are presented in Table 2-7.

Table 2-5. Design premises related to the functions the plug shall maintain during the sealing phase.

Function or property	Property and design parameters to be designed	Design premises
<i>The plug shall resist the hydrostatic pressure at repository depth and the swelling pressure of the backfill until the main tunnel is filled.</i>	The strength of the concrete plug. Concrete recipe: <i>amount and composition of binder.</i> Reinforcement: <i>quality and amount.</i>	<i>The sum of the hydrostatic water pressure at the repository level and the swelling pressure from the backfill in the tunnel section adjacent to the watertight seal.</i> <i>5 MPa water pressure and the swelling pressure from the backfill in the section adjacent to the plug.</i>
	<i>Maximum applied swelling pressure.</i> <i>Length and installed density (block filled part of the volume) in the tunnel section adjacent to the plug.</i>	<i>The strength and dimensioning load of the concrete plug.</i>
<i>The plug shall limit water flow until the adjacent main tunnel is filled and saturated.</i>	The watertightness of the plug. Watertight seal: Material composition: <i>montmorillonite content.</i> <i>Installed density: the bulk density, water content and dimensions of the components (blocks and pellets), the geometry of the installed components.</i>	<i>The amount of water accepted to pass the plug.</i> <i>The accepted water volume will depend on the acceptable transport of clay material out from the deposition tunnel during this phase and remains to be determined.</i>
	The watertightness of the plug. Properties of the interface rock/grouting/concrete.	
<i>The plug shall be durable and maintain its functions in the environment expected in the repository facility and repository until the closure in the main tunnel is saturated.</i>	Concrete plug deformation properties and bond between concrete plug and the rock. Concrete recipe: <i>amount and composition of binder.</i> Reinforcement: <i>quality and amount.</i>	<i>The sum of the hydrostatic water pressure on repository level and the swelling pressure from the backfill and the watertight seal.</i> <i>5 MPa water pressure and the swelling pressure from the backfill in the backfill adjacent to plug.</i> <i>The displacement of the concrete plug that can be accepted with respect to the decrease in density and resulting increase in conductivity of the watertight seal.</i>
	Bond between concrete plug and the rock (<i>water conductive features must not be formed</i>).	<i>See design premise for limitation of water flow.</i>
	The strength of the concrete plug. Concrete recipe: <i>amount and composition of binder.</i> Reinforcement: <i>quality and amount.</i>	<i>Thermal loads from the decaying fuel causing expansion of the rock and concrete.</i> <i>The temperature variations that can be expected at repository depth, i.e. the increase in repository temperature caused by the decay power of the spent nuclear fuel, and situations where repository temperature does not increase due to ventilation related heat transfer in the main tunnels.</i>
	Concrete plug durability. Concrete recipe. Reinforcement: <i>quality.</i> <i>Drainage pipes durability.</i> <i>Material corrosion class.</i>	<i>Humidity and groundwater composition occurring in the final repository facility.</i>
	<i>Concrete plug design working life.</i> <i>Drainage pipes design working life.</i>	<i>The design working life is 100 years.</i>

Table 2-6. Design premises related to the production of the plug.

Design consideration	Required property	Design premises
<i>Plugs with specified properties shall be possible to prepare and install with high reliability.</i>	<i>The thermal, viscoelastic and shrinkage properties of the concrete shall be such that internal cracking in the young concrete will not compromise the ability of the plug to achieve its functional requirements.</i>	<i>Tensile stresses resulting from the thermal expansion due to cement hydration during the curing and subsequent contraction as it cools.</i>
	<i>The filter material, its grain size distribution and compaction shall be such that the filter can collect and drain water so that the concrete plug is not exposed to high water pressures until it has gained sufficient strength.</i>	<i>Volume and inflow rate of water to be drained.</i>

Table 2-7. Design premises imposed by the plug on the design of deposition tunnels.

Required property	Design premises
Curing and sealing phases	
<i>Inflow/seepage of water to the part of the deposition tunnel where the plug shall be installed must be limited since excessive water inflow during construction of the concrete plug may impact the properties of the finished plug.</i>	<i>Accepted inflow rate (has not been determined at this stage of development).</i>
<i>A recess for foundation of the concrete plug shall be prepared in the rock.</i>	<i>Geometry of the reference concrete plug.</i>
<i>Anchoring for structures for the installation of the plug shall be prepared in the rock.</i>	<i>Geometry and loads according to the reference design of the plug.</i>
<i>The strength and properties of the rock in the area of the recess for the concrete plug and the anchoring for temporary structures shall be suitable for the construction, i.e. sufficient to resist the pressure transmitted from the plug without fracturing.</i>	<i>The forces transmitted from the plug to the rock.</i>

3 Reference design of the backfill

The reference design of the backfill shall conform to the design premises presented in Section 2.3 and be technically feasible to produce by applying the methods for preparation and installation described in Chapter 5 Production of the backfill.

The reference design is described by a set of *design parameters* for which nominal values and acceptable variations are given. In the verification of the reference design it shall be shown that the backfill for the specified values of the design parameters conform to the design premises. The design parameters shall be inspected in the production to verify that the produced backfill conform to the reference design, and to provide an estimation of the actual properties of the backfill at the initial state.

3.1 Backfill material and components

3.1.1 Material composition

Materials that may be used as backfill can be divided into three main categories: bentonite clays, smectite-rich mixed layer clays and mixtures of bentonite and ballast.

The reference backfill material is a bentonite clay with the material composition specified in Table 3-1. Examples of commercial bentonites with this material composition are IBECO-RWC-BF (from Milos), Asha (from Kutch) and MX-80 (from Wyoming). A delivery of bentonite from Milos, which also is an example of a material with the specified composition, is within this report referred to as Milos backfill.

The design parameter of the raw material that determine the properties of the backfill is the montmorillonite content. The montmorillonite content in the backfill material shall be sufficient for the saturated backfill to yield and maintain the required hydraulic conductivity and swelling pressure according to **Design premises long term safety**. The montmorillonite content will also affect the compressibility of the material and the capacity of the backfill to restrict upwards swelling/expansion of the buffer.

When determining the reference material the material specific relationships between density and hydraulic conductivity and swelling pressure as well as the loss of buffer density by upwards swelling were evaluated for alternative candidate materials /Johannesson and Nilsson 2006/. Bentonites with a montmorillonite content according to Table 3-1 were concluded to yield the required properties for technically achievable densities.

The backfill material must not contain substances that may cause harmful buffer degradation or canister corrosion. Currently neither substances nor limits have been specified as design premises from the assessment of the long-term safety. Substances occurring in bentonite clays used for the buffer identified as potentially harmful in **Design premises from long-term safety** are sulphide, sulphur and organic carbon.

In the production the content of montmorillonite shall be inspected and its conformity to the reference design at the initial state shall be verified. In addition to the montmorillonite content the dominant cation and the cation exchange capacity (CEC) are important material parameters.

Table 3-1. Reference backfill raw material.

Design parameter	Nominal design (wt-%)	Accepted variation (wt-%)
Montmorillonite content	50–60	45–90

Further, sulphide, sulphur and organic carbon have been identified as potentially harmful for the barrier functions of the other barriers. Dominant cation, CEC, sulphide, sulphur, organic carbon and content of accessory minerals will vary between different bentonites, and to some extent also between different deliveries of the same bentonite product. In Table 3-2 the contents in Milos Backfill, Asha and MX-80 are specified. SKB plans to measure and document these material parameters in the production. However their conformity to the specified contents must not be verified for the initial state.

3.1.2 Material ready for compaction

In Table 3-3 and Figure 3-1 the granule size distribution and water content of the reference conditioned material ready for compaction are specified.

The design premises considered in the specification of the reference material ready for compaction are that it must be possible to compact into blocks and pellets of the required density and that the production shall be reliable, see Table 2-2. Further the blocks shall be homogenous and free from cracks and damage. The density and homogeneity of the produced blocks and pellets will depend on the granule size distribution, the water content of the material to be compacted and on the compaction pressure applied during block manufacturing. To achieve high reliability in the production, the granule size distribution and water content must be specified. The specification will depend on the chosen bentonite material. The specifications in Table 3-3 and Figure 3-1 are based on Milos backfill, other materials will require establishment of different specifications.

Table 3-2. Dominant cation, CEC and accessory minerals for backfill materials according to the reference design.

Parameter	Nominal content Milos backfill /Olsson and Karnland 2009/	Nominal content Asha (Kutch) /Olsson and Karnland 2009/	Nominal content MX-80 /Karnland et al. 2006/
Cation (%)			
Mg	48	55	72
Ca	41	31	18
CEC (meq/100 g)	73	97	75
Sulphide content (%)	~0.03	~0	limited
Total sulphur content (including the sulphide) (%)	0.06	0.11	limited
Organic carbon (%)	0.38	0.14	limited
Calcite (wt-%)	~8	~2	0–1
+ Siderite (wt-%)	n.d.	n.d.	
Quartz (wt-%)	n.d.	1–2	3
Cristobalite (wt-%)	n.d.	n.d.	2
Pyrite (wt-%)	n.d.	n.d.	0.07
Mica/illite (wt-%)	6–8	n.d.	4
Gypsum (wt-%)	~0.5	~0.9	0.7
Albite (wt-%)	n.d.	n.d.	3
Ca-plagioclase (wt-%)	~1.5	~2	
K-feldspar (wt-%)	5–6	3–4	
Dolomite (wt-%)	~16	n.d.	0
Kaolin (wt-%)	n.d.	~2	
n.d. Not detected			

Table 3-3. Reference processed material ready for compaction for Milos backfill.

Design parameter	Nominal design	Accepted variation
Granule size distribution	–	See Figure 3-1
Water content block material (wt-%)	17	±2
Water content pellet material (wt-%)	17	±2

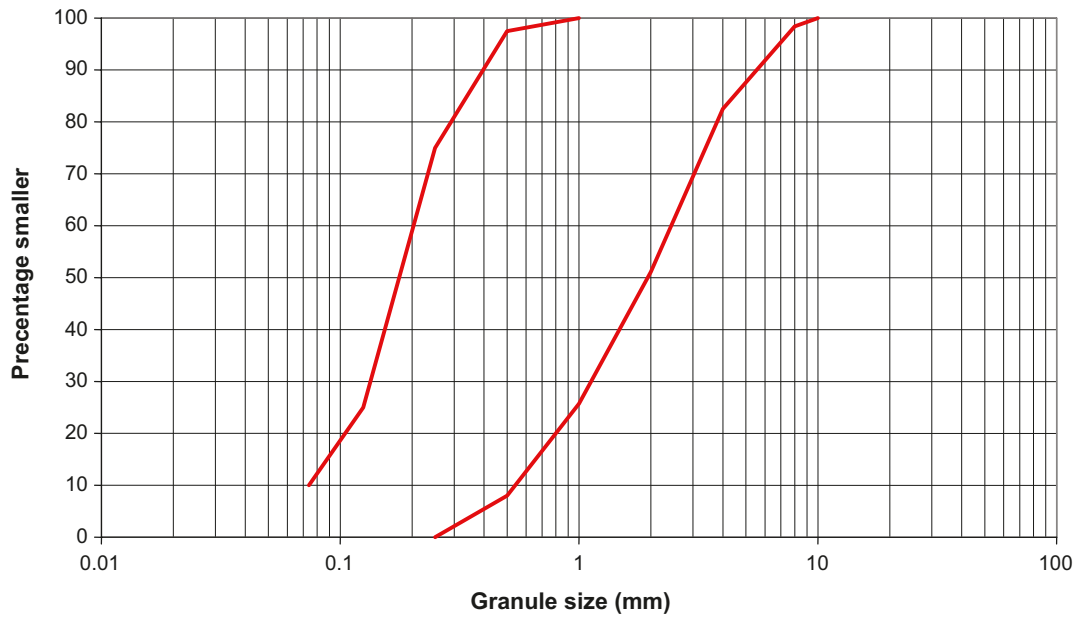

Figure 3-1. Granule size distribution – accepted variation for Milos backfill. The registered grain size distribution in the material ready for compaction shall lie between the two red lines.

3.1.3 Blocks and pellets

The reference design of blocks, pellets and bottom bed material are presented in Table 3-4. The design parameters specify the properties that the different components shall have when they are installed. The different backfill components have different densities. With respect to this, in order to facilitate the determination of the installed density in the deposition tunnel, the densities are expressed as dry density and the water content is specified. In the actual production process the bulk densities will be inspected. The relations between bulk, dry and saturated densities are presented in Appendix A.

Table 3-4. Reference block, pellet and bottom bed material ready for installation (based on Milos backfill).

Design parameter	Nominal design	Accepted variation
Blocks		
Dry density (kg/m ³)	1,700	±50
Water content (wt-%)	As in the material ready for compaction	As in the material ready for compaction
Dimensions (mm ³)	700×667×510	±2×2×2
	700×600×250	±2×2×2
Blocks in deposition hole bevel¹		
Dry density (kg/m ³)	1,710	±17
Water content (wt-%)	17	±1
Dimensions (mm)	Height: 500	±1
	Diameter 1,650	
Pellets and bottom bed pellets²		
Dry density separate pellets (kg/m ³)	1,700	±50
Dimensions (mm ³)	~16×16×8	–
Dry density of loose filling (kg/m ³)	1,000	±100
Water content (wt-%)	As in the material ready for compaction	As in the material ready for compaction

¹ In the reference design buffer blocks are used and the design parameters are the ones specified for solid blocks in the **Buffer production report**, Table 3-4.

² In the reference design the same kind of pellets are used for the bottom bed and the gap between the blocks and tunnel walls. This may be changed.

The blocks and pellets are designed to conform to the design premises for hydraulic conductivity, swelling pressure and capacity to restrict upward swelling/expansion of the buffer presented in Table 2-1. The reference design must also conform to the design premises related to production and operation presented in Table 2-2. The block, pellet and bottom bed pellet dimensions and densities are determined by the installation technique, the acceptable geometry of the deposition tunnels and the geometrical configuration of the installed backfill. The dimensions of the pellets need to be specified and inspected for the production but regarding the installed density it is sufficient to specify the density in the volume filled by the pellet materials. The dimensions and density of the individual pellets may very well be altered as long as they can be installed in a reliable way.

3.2 Installed backfill

The reference design of the installed backfill is presented in Table 3-5, Figure 3-2 and Figure 3-3.

The installed dry density will depend on the volume of the deposition tunnel and the mass of backfill material installed in the tunnel. The installed density is calculated per blasting round. It is determined from the acceptable blasting round volume according to Figure 2-1, the dry densities of blocks and pellets and the portions of the volume filled with blocks, pellets and bottom bed. The larger portion of the tunnel that is filled, and the less void volume the larger installed density. Since higher densities can be achieved if the material is pressed into blocks, a higher portion of blocks will result in a higher installed density. For the reference design of backfill components and geometry of the installed backfill the installed dry density in a tunnel section can be calculated according to Equation 3-1.

$$\rho_d = \frac{\rho_{db} / (1 + dV_s) + \rho_{dp} \cdot V_p / (V_t - V_p)}{1 + V_p / (V_t - V_p)} \quad (3-1)$$

where

ρ_d = average dry density of a tunnel section

ρ_{db} = dry density of the blocks

ρ_{dp} = dry density of the pellets filling

dV_s = volume fraction of slots between the blocks

V_p = volume of pellets filling and bottom bed

V_t = total volume

Table 3-5. Reference design of installed backfill (based on Milos backfill).

Design parameter	Nominal design	Accepted variation
Blocks		
Block part of blast round volume ¹	According to Figure 3-2	$V_{\text{blocks}} \geq 60\%$
Free space between blocks and tunnel walls	–	Free space ≥ 10 cm
Pellet filling in gap between blocks and tunnel walls		
Pellet part of blast round volume	The volume between the installed blocks and deposition tunnel walls	–
Bottom bed		
Thickness	10 cm from nominal tunnel floor	–
Inclination perpendicular to the tunnel axis	–	< 3 mm/tunnel width
Inclination along the tunnel axis	Inclination of nominal tunnel floor	–
Dry density compacted bed	$> 1,200$ kg/m ³	–

¹ Including blocks in the upper part of the deposition hole and excluding slots between blocks.

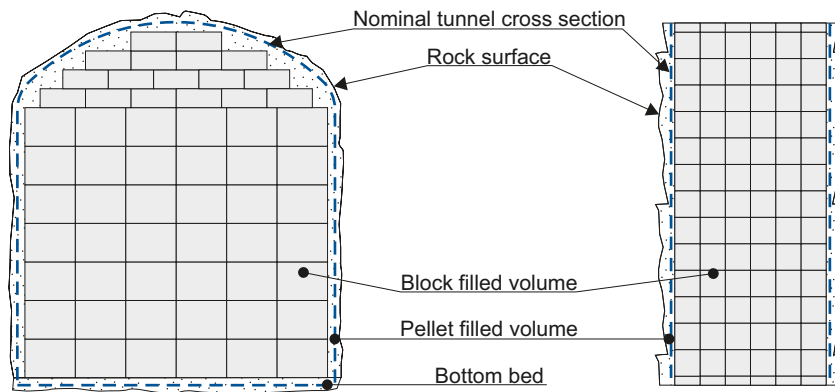

Figure 3-2. Reference geometry of the installed backfill in a schematic tunnel.

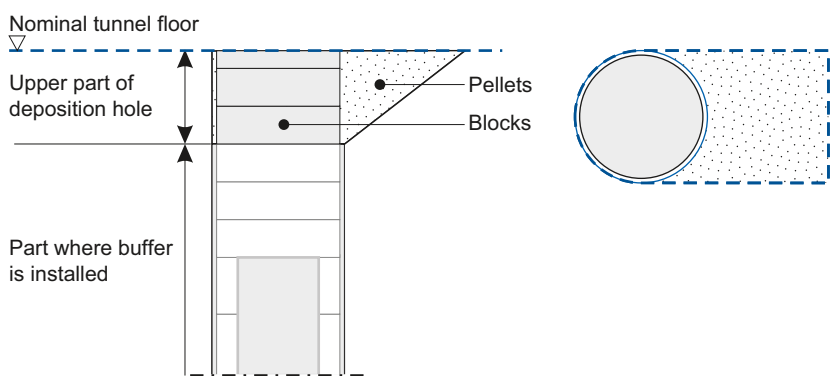

Figure 3-3. Reference geometry of the backfill in the upper part of the deposition hole.

The installed dry density of the backfill in the upper part of the deposition hole can be calculated according to Equation 3-1 setting dV_s to zero, V_t to the total volume of the upper part of the deposition hole and V_p to the pellet filled part of this volume. The calculated installed density for the reference design of backfill components according to Table 3-4 and the installed backfill according to Table 3-5, Figure 3-2 and Figure 3-3 is presented in Table 3-6.

Table 3-6. Calculated installed dry density for the reference design of backfill components and installed backfill. The tunnel volume is set to the largest acceptable.

Parameter	Tunnel cross section	Upper part of deposition hole
Dry density of blocks (ρ_{db})	1,700 kg/m ³	1,710 kg/m ³
Dry density of pellets (ρ_{dp}) ¹	1,000 kg/m ³	1,200 kg/m ³
Volume fraction of slots between blocks (dV_s)	2%	0
Volume of pellets filling and bottom bed	Total volume minus block and void part of the volume Nominal: 25-16.8·(1+0.02) m ³ /m Accepted: 25-0.60·25(1+0.02) m ³ /m	2.56 m ³
Total volume	Maximum accepted tunnel blasting volume 25 m ³ /m	5.17 m ³
Calculated installed dry density (nominal block part of cross section and largest acceptable tunnel volume)	1,458 kg/m ³	1,457 kg/m ³
Calculated installed dry density (acceptable block part of cross section and largest acceptable tunnel volume)	1,408 kg/m ³	—

¹ For the tunnel cross section the same density is used for the pellets filling between blocks and tunnel walls and bottom bed.

For the selected material the installed density shall be sufficient for the saturated backfill to limit advective transport throughout the tunnel cross section and length and to reach a swelling pressure sufficient to seal any inhomogeneities, channels and open spaces and yield a tight contact with the rock surface. Further the backfill material shall at the installed density provide a sufficient counter pressure to restrict buffer expansion both before and after saturation.

It shall also be possible to install the specified portions of blocks and pellets in a reliable way taken into consideration the acceptable deposition tunnel geometry. A minimum limit for the free space between the installed blocks and deposition tunnel walls must be set with respect to the space required for the pellet installation equipment. Further, to achieve a reliable installation the bottom bed needs to be compacted so that the density is high enough to yield sufficient bearing capacity for the blocks, and flat enough to yield a symmetric block masonry.

Investigations of alternative materials /Johannesson and Nilsson 2006/ have shown that the density required to restrict upwards buffer swelling/expansion, which is the largest of the densities required to conform to the design premises, is decisive for the design. To maintain the function a margin to potential material losses during installation, saturation and in the repository after saturation is added. When determining the portion of the tunnel to be filled with blocks the material specific achievable densities and water ratios of the blocks and pellets as well as the need to add a margin and achieve a reliable production and installation with respect to the tunnel contour were considered.

4 Conformity of the reference backfill to the design premises

The objective of this chapter is to verify the conformity of the reference backfill design, i.e. the material composition, the densities, dimensions and water contents presented in Sections 3.1 and 3.2 to the design premises presented in Section 2.3. In Section 2.3 the design premises for the backfill are divided into design premises:

- related to the barrier functions in the KBS-3 repository,
- from other engineered barriers,
- related to the production and operation.

Design premises related to the barrier functions in the KBS-3 repository are stated in **Design premises long-term safety**. In summary the following shall be verified for the reference design with respect to the long-term safety:

- the specified backfill material yields at the installed density a hydraulic conductivity of less than 10^{-10} m/s,
- the specified backfill material yields at the installed density a swelling pressure of more than 0.1 MPa,
- the specified material and the packing and density of the installed backfill is sufficient to ensure a compressibility that results in a minimum saturated buffer density of 1,950 kg/m³ with margin to loss of material and uncertainties,
- the backfill material does not contain substances that may cause harmful buffer degradation or canister corrosion,
- the density and material composition shall be such that the barrier functions of the backfill can be maintained during long time.

Except for the design premises related to the backfill's barrier functions there are no design premises set for the backfill by the other barriers. With respect to the production and operation it shall be verified that:

- it is possible to compact the material to the required density,
- the blocks, pellets and bottom bed are designed so that they can be installed with high reliability.

In the following sections verifying analyses of these issues are presented.

4.1 Hydraulic conductivity and swelling pressure

According to the design premises the hydraulic conductivity of the saturated backfill shall be less than 10^{-10} m/s and the swelling pressure shall be at least 0.1 MPa. The material specific relationships between density and hydraulic conductivity and swelling pressure for materials with the composition given in Table 3-1 have been evaluated by laboratory tests. The density required to yield a specific hydraulic conductivity and swelling pressure will depend on the salinity of the water saturating the material. Consequently the relation between density and the required properties has been investigated for the range of salinities that may occur in the repository.

Low salinity results in lower hydraulic conductivity and higher swelling pressure. In the final repository the salinity is expected to vary due to drainage of the facility during operation, local variations in the natural groundwater composition and as the result of changing climate domains that can be expected at the repository site in the long-term perspective, as discussed in /SKB 2006b/. In /SKB 2006a, Table 9-23/ examples of groundwater compositions that may occur at the repository site are given, the highest reported salinity is 7.4%. In **Design premises long-safety** it is stated that

the buffer shall maintain its hydraulic conductivity and swelling pressure for chloride concentrations up to 1 M. This corresponds to a salinity of 5.6% if 50% NaCl and CaCl₂ is assumed. The material specific relationships between salinity and hydraulic conductivity and swelling pressure have been determined for salinities of 3.5% corresponding to ocean water and 7% representing a high end salinity. The results are shown in Figure 4-1 and Figure 4-2.

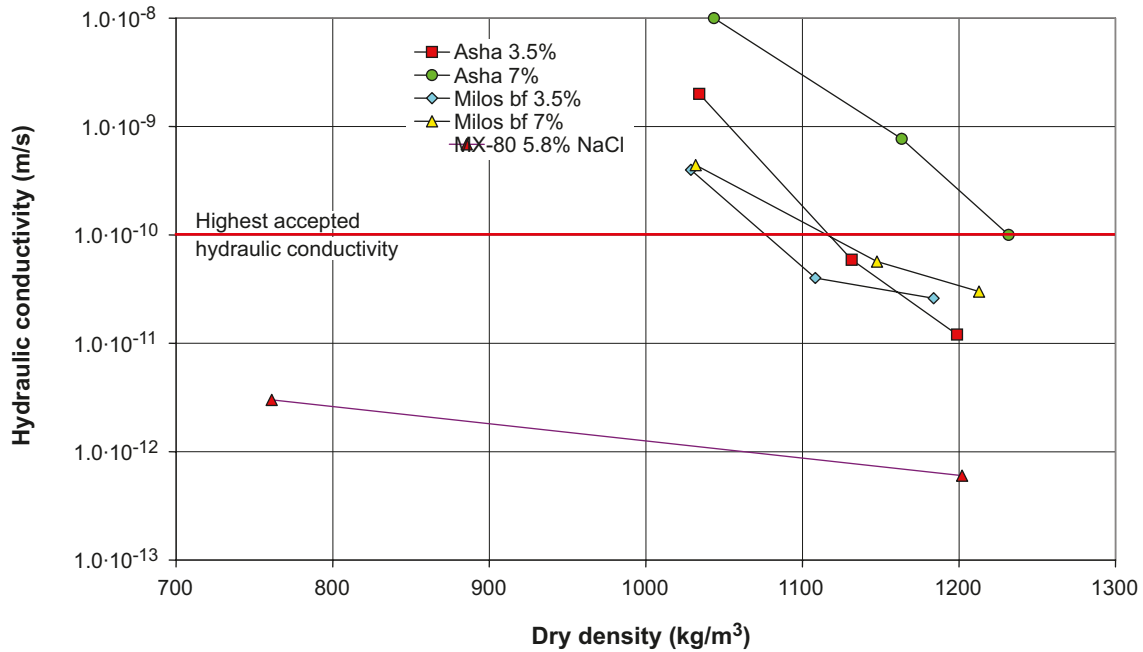

Figure 4-1. The material specific relation between density and hydraulic conductivity for three materials according to the reference design including the example material Milos backfill. Asha and Milos backfill based on /Johannesson and Nilsson 2006/ and MX-80 on /Karmland et al. 2006/.

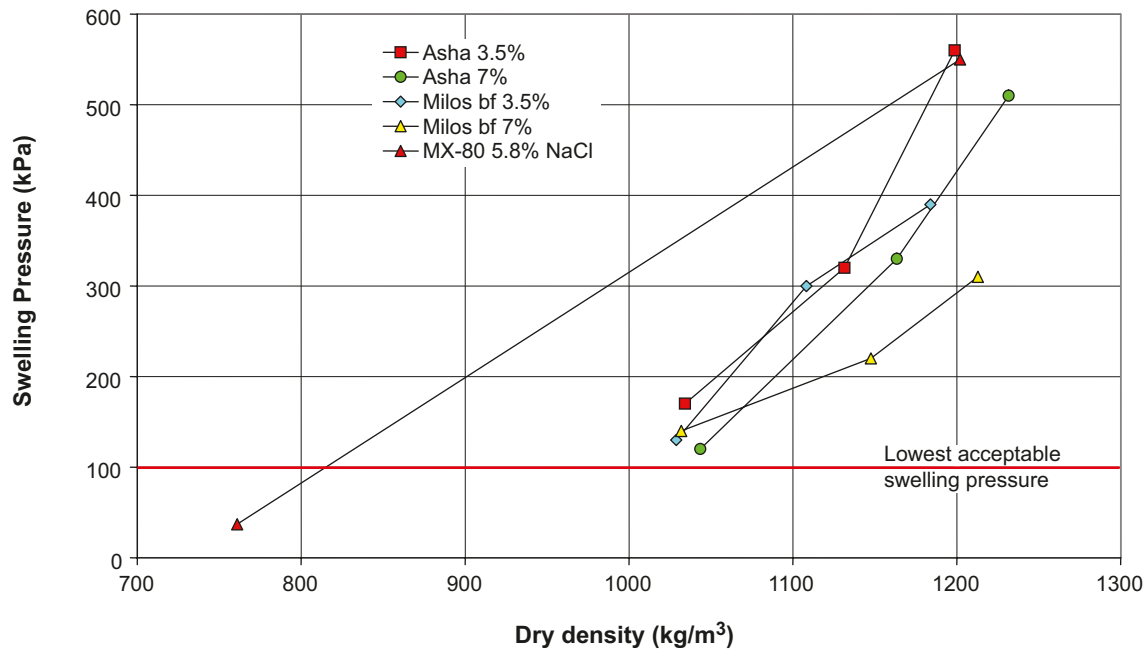

Figure 4-2. The material specific relation between density and swelling pressure for three materials according to the reference design including the example material Milos backfill. Asha and Milos based on /Johannesson and Nilsson 2006/ and MX-80 on /Karmland et al. 2006/.

Based on the results presented in Figure 4-1 a dry density of 1,100 kg/m³ is required for Milos backfill to reach a hydraulic conductivity less than 10⁻¹⁰ m/s for a salinity of 3.5%. For Asha the corresponding dry density is 1,120 kg/m³. When the salinity was increased to 7% the required dry densities increased to 1,120 kg/m³ for Milos backfill and to 1,230 kg/m³ for Asha.

Based on the results presented in Figure 4-2 a dry density of about 1,050 kg/m³ is required for both Milos backfill and Asha to reach a swelling pressure of at least 0.1 MPa (100 kPa) both for a salinity of 3.5% and 7%.

The average installed dry density will for the reference design exceed 1,450 kg/m³, which gives a considerable margin to the dry densities required according to the results in Figure 4-1 and Figure 4-2. For higher densities the hydraulic conductivity is decreased and the swelling pressure increased. The required density was determined for a salinity of 3.5% and 7%. Lower salinities can be expected during long periods /SKB 2006a/. For lower salinities the hydraulic conductivity will decrease and the swelling pressure increase. Consequently the hydraulic conductivity and swelling pressure of the reference backfill material will at the installed density conform to the design premises, and there will be a margin to density losses.

4.2 Compressibility and restriction of buffer swelling/expansion

The backfill material shall at the installed density provide a sufficient counter pressure to restrict buffer swelling/expansion. The saturated density of the buffer must not be lower than 1,950 kg/m³. The density and loss of buffer density by upwards swelling/expansion has been evaluated by calculations based mainly on the swelling properties of the buffer and the swelling pressure and the compressibility of the backfill. Also the influence of dry conditions in the tunnel has been investigated.

In order to investigate the upwards swelling of the buffer both analytical and finite element model calculations have been performed for two extreme cases a *wet case* and a *dry case*. The wet case corresponds to a case with a completely saturated and homogenised backfill and the dry case corresponds to a completely dry tunnel and the blocks and pellets in the same state as when installed. In both cases the initial saturated buffer density was set to 2,000 kg/m³. The main property that resists buffer swelling and expansion is the compressibility of the backfill. Figure 4-3 shows measured relations between the compression stress and the dry density of water saturated backfill materials. The compressive force yields a compressive stress in the material. This is the same as “vertical stress” in Figure 4-3.

The *analytical calculations* are described by /Johannesson and Nilsson 2006, Johannesson 2008/. The principle of the calculations is that vertical swelling of the buffer will continue until force equilibrium in vertical direction between swelling and counteracting forces is reached. The criterion established regarding buffer swelling is that the density at saturation of the buffer should not be less than 1,950 kg/m³ above the canister. The upwards swelling pressure of the buffer is counteracted by the friction between the buffer and the rock, the swelling pressure of the backfill and the compressibility of the backfill. The upwards displacement of the buffer/backfill interface can be calculated as a function of the resulting swelling pressure. In a similar way the compression of the backfill can be calculated as a function of the pressure at the interface. When plotting both the swelling of the buffer and the compression of the backfill as a function of the total vertical pressure at the buffer/backfill interface the curves will intersect in a point where the swelling is equal to the compression and the swelling pressure agrees with the compression pressure. This point defines equilibrium and thus gives the upwards displacement.

The analytical calculations of the wet case (completely water saturated backfill) reported by /Johannesson and Nilsson 2006/ showed that the resistance provided by the backfill to upwards swelling of the buffer will be acceptable for installed backfill dry densities of at least 1,240 kg/m³ for Milos backfill material.

The analytical calculations of the dry case (completely un-wetted backfill) reported by /Johannesson 2008/ were made to check the upwards swelling when the only counteracting forces generated by the backfill were the stiffness of the un-wetted backfill blocks, the deformation of the joints between

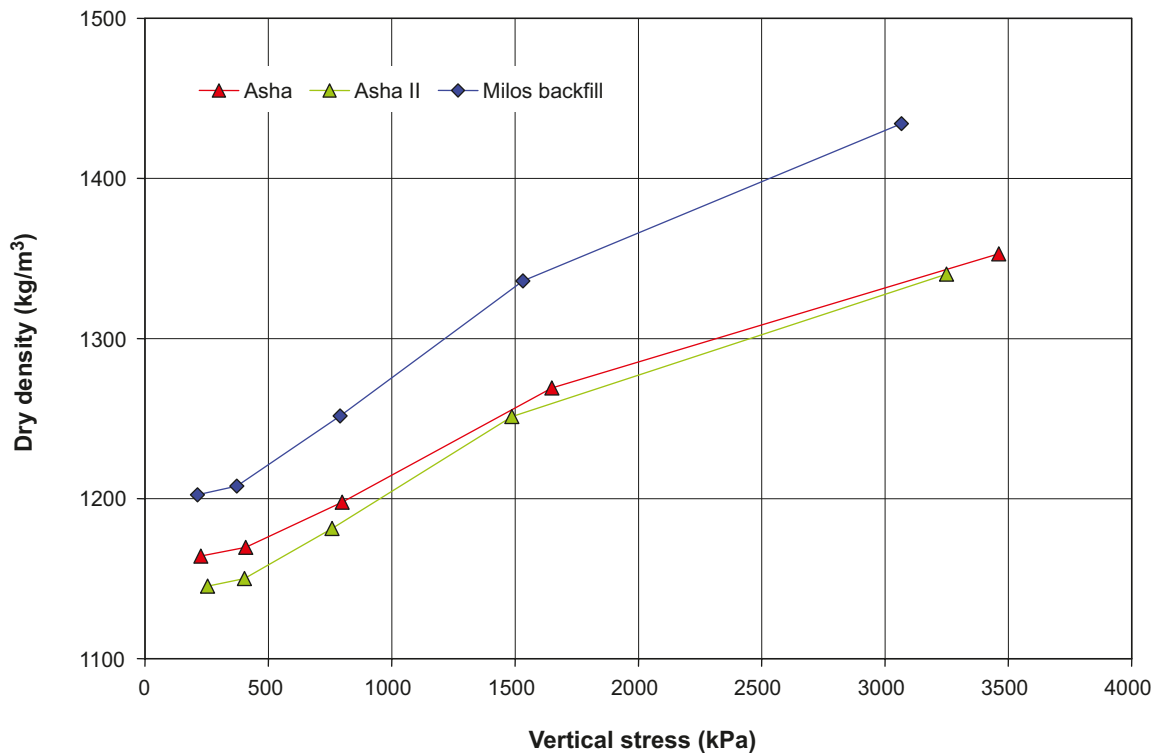

Figure 4-3. The material specific relation between vertical stress and dry density for two example materials including the reference material Milos backfill /Johannesson and Nilsson 2006/.

the blocks and the compression properties of the dry pellets filling. The calculations resulted in an upwards swelling of 13 cm yielding a decrease in density of the buffer above the canister from 2,000 kg/m³ to 1,970 kg/m³.

The *finite element calculations* are described by /Börgesson and Hernelind 2009/. In these calculations the entire swelling/compression process is modelled as a function of time and thus yields not only the state at equilibrium but also the entire swelling process. The conceptual model and acting forces are the same as in the analytical calculations.

The finite element calculations largely confirm the results of the analytical calculations. For the reference backfill the dry case is the most severe yielding a saturated density of 1,960 kg/m³ above the canister. Figure 4-4 shows the results of the finite element calculations of the dry case. The void ratio distribution after completed swelling is shown. The void ratio 0.87 corresponds to the density at saturation of 1,950 kg/m³. The figure shows that the void ratio on top of the canister is about 0.85 corresponding to a density at saturation of 1,960 kg/m³.

The analytical and finite element calculations were made with the assumption that the initial density at saturation of the buffer is 2,000 kg/m³. A lower buffer density reduces the margin to 1,950 kg/m³ but reduces also the swelling and expansion and vice versa. This means that the initial buffer density above the canister only have limited effect on the resulting density after swelling and expansion of the buffer and compression of the backfill. An increased salinity of the ground water will decrease the swelling pressure of both the buffer and the backfill and thus not affect the swelling/expansion process very much.

The results show that the upwards swelling of the buffer is small in the wet case and yields an acceptable decrease of buffer density. The buffer density is reduced below the acceptable limit of 1,950 kg/m³ if the average installed backfill dry density is less than 1,240 kg/m³.

The dry case yields the largest displacements (10–15 cm) but the density above canister remains over 1,950 kg/m³. The dry case is however theoretical since it is unrealistic that the buffer can be completely water saturated at the same time as the tunnel is completely dry.

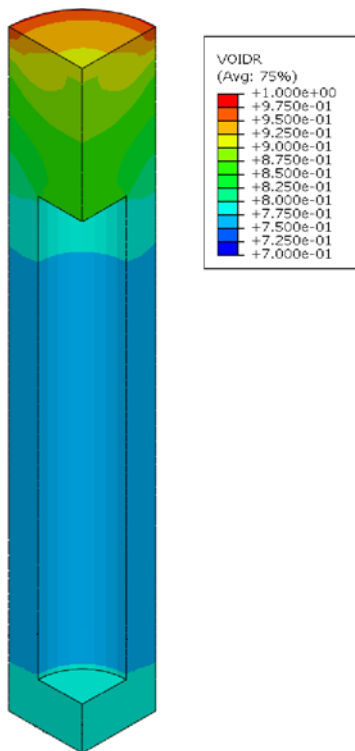

Figure 4-4. Void ratio distribution in the buffer after completed swelling (dry case).

The presented results show that an average installed dry density of the backfill of 1,240 kg/m³ is sufficient to prevent so much upwards swelling/expansion of the buffer during wet conditions that the saturated density of the buffer above the canister is reduced from 2,000 to 1,950 kg/m³. For a backfill with the reference composition and installation the calculations show that the buffer will expand a few centimetres upwards in the deposition hole during wet conditions. For dry conditions the reference density yields a larger but still acceptable loss in buffer density.

4.3 Substances that may cause harmful buffer degradation or canister corrosion

The backfill material must not contain substances that may cause harmful buffer degradation or canister corrosion. Currently neither substances nor limits are given as design premises from the assessment of the long-term safety. Consequently the conformity of the backfill reference design to this design premise will be verified in the long-term safety assessment.

4.4 Maintain the barrier functions

The backfill shall maintain its barrier functions and be long-term durable in the environment expected in the repository. For the selected material the installed backfill density shall be sufficient for the saturated backfill to yield the required hydraulic conductivity and swelling pressure. Further the backfill material shall at the installed density provide a sufficient counter pressure to restrict buffer expansion both before and after saturation.

For any backfill material the capability to maintain the barrier functions will depend on the density. As mentioned in Section 3.2 and evident from Sections 4.1 and 4.2 it is the density required to restrict buffer swelling/expansion that is dimensioning for the installed backfill density.

In the final repository facility during installation some backfill material may be lost. Material may also be lost in the future during the assessment period both during and after saturation of the backfill. Neither of these material losses has yet been fully quantified. However, in /SKB 2006a/ it was concluded that a smectite-rich mixed layer clay can maintain the barrier functions and that piping with erosion at early stages will not be so extensive that it results in diminished barrier functions. These conclusions were drawn for a margin of about 15% between the installed dry density and the dimensioning density.

In Figure 4-5 the margins between the installed dry density and the dimensioning density for alternative block parts of the tunnel volume are shown for two materials according to the reference design, Milos backfill and Asha. The margin is 14–25% for Milos backfill and 21–33% for Asha.

The capability of the backfill to maintain its barrier functions will also depend on the ionic strength of the ground water. In Section 4.1 the relations between density and hydraulic conductivity and density and swelling pressure were analysed for different salinities. The analysis shows that materials according to the reference design are rather insensitive to alterations in salinity.

4.5 Design premises from production and operation

4.5.1 Compactability of the backfill material

It shall be verified that it is possible to compact the backfill material to the required density. The density achieved at compaction will depend on the granule size distribution and water content of the material ready for compaction and on the compaction pressure. The required granule size distribution, water content and pressure are material specific. The reference material ready for compaction presented in Table 3-3 and Figure 3-1 is based on Milos backfill and must be revised if another material is selected.

When a backfill material and supplier is selected it shall be verified that it is possible to compact the material from the selected deposit to the required density. Tests in which blocks are pressed from material samples with different granule size distribution and water content will be performed. SKB will develop test programmes for this purpose as a part of the routines for qualification of suppliers, also see Section 5.1.4.

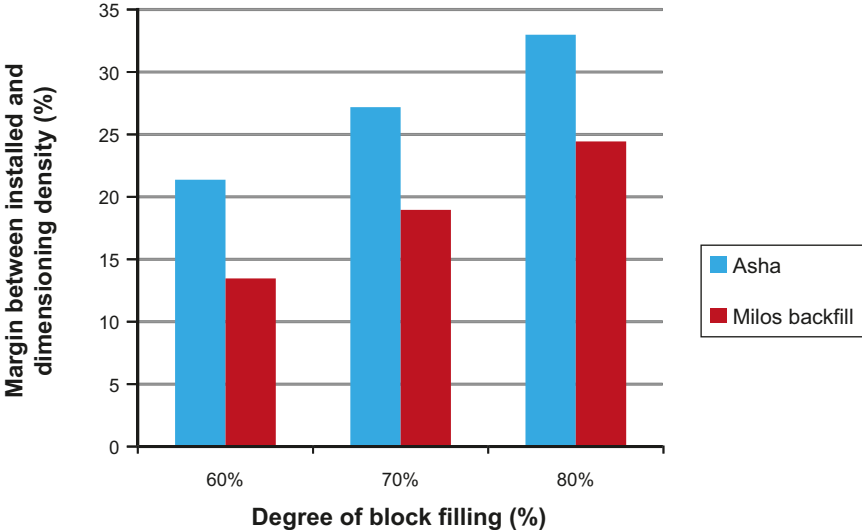

Figure 4-5. Margin between the installed and dimensioning density for Milos backfill and Asha at different block parts of the tunnel volume. Dimensioning density for Asha 1,160 kg/m³ from /Gunnarsson et al. 2006/.

4.5.2 Geometrical configuration and design of blocks, pellets and bottom bed pellets

The backfill components shall be designed so that installation can be performed with high reliability. Details in the reference design that will impact the reliability of the installation are the geometrical configuration in the deposition tunnel, the dimensions and densities of the blocks and the granule size distribution and density of the pellets.

A thorough analysis of the excavated tunnel volume excavated using careful drill and blasting in an industrially applicable and efficient way was done by /Wimelius and Pusch 2008/. They found that such excavation results in chamfered walls from the drill holes made for the blasting and a potentially a relatively large degree of over-breakage (over-excavation). The actual tunnel volume can exceed the nominal volume by up to 30%, see Figure 2-1.

Large irregularities in the tunnel walls and the saw-toothed shaped rock profile caused by the applied excavation technique makes it difficult to yield the required density unless a portion of the tunnel volume is filled with blocks of clay material that can be pre-compacted to a high density. Full scale tests have shown that neither filling more than the nominal volume with blocks nor reducing the irregularities in the tunnel walls is feasible to achieve a reliable industrial process at the required rate /Wimelius and Pusch 2008/. Based on the tunnel geometries that can be expected and geometrical block configurations that are deemed to be achievable with high reliability in the production, the block filling degree is currently set to at least 60%.

With the reference blocks, pellets and geometrical configuration of the installed backfill a margin to the required density of about 15% can be achieved for the reference material. Results and experiences from tests are presented in Sections 5.3.7 and 5.4.11.

In addition to achieve the required density with high reliability the geometrical configuration of the backfill material and the installation technique shall be such that the seepage into the deposition tunnels and the resulting hydraulic processes that take place during installation do not impair the barrier functions of the backfill. Performed tests show that this can be achieved see Section 5.4.11.

4.6 Summary of results and conclusions

4.6.1 Hydraulic conductivity and swelling pressure

In **Design premises long-term safety** it is stated that the hydraulic conductivity of the backfill shall be less than 10^{-10} m/s and the swelling pressure at least 0.1 MPa. The related backfill properties and design parameters to be determined are:

- backfill property: *material composition*,
 - design parameter: *montmorillonite content*,
- backfill property: *installed density*,
 - design parameters: *dry density and water content of backfill components, block, bottom bed and pellet filling portions of the deposition tunnel volume*.

The montmorillonite content shall be sufficient for the backfill material to have capacity to yield the required hydraulic conductivity and swelling pressure at technically feasible installed densities. The installed density shall for the selected material be sufficient to maintain the required conductivity and swelling pressure in the final repository.

In Section 4.1 it is verified that the reference installed backfill as presented in Table 3-4, Table 3-5, Figure 3-2 and Figure 3-3 for materials with the reference montmorillonite content stated in Table 3-1 will yield the required hydraulic conductivity and swelling pressure for salinities that may occur in the final repository. It is shown that the hydraulic conductivity and swelling pressure of the reference backfill material at the installed density will conform to the design premises with a margin.

4.6.2 Compressibility restricting buffer swelling/expansion

In **Design premises long-term safety** it is stated that the packing and density of the backfill, both at initial dry state and after complete water saturation must be sufficient to ensure a compressibility that results in a saturated density of the buffer of at least 1,950 kg/m³. Further it is stated that there shall be a margin to loss of backfill and uncertainties. The related backfill properties and design parameters to be determined are:

- backfill property: *material composition*,
 - design parameter: *montmorillonite content*,
- backfill property: *installed density*,
 - design parameters: *dry density and water content of backfill components and block, bottom bed and pellet filling portions of the deposition tunnel volume*.

In Section 4.2 the expansion and density decrease of the buffer was investigated for a dry and a wet case. The dry case represents the largest physically possible drop in buffer density. This case will overestimate the density drop for all conditions that may occur in the final repository. The wet case illustrates the expansion when both buffer and backfill are fully saturated. The performed analyses show that an installed dry density of at least 1,240 kg/m³ is sufficient to maintain the saturated buffer density above the canister above 1,950 kg/m³. This result is valid for Milos backfill, other materials would need to be evaluated to determine the density required for them to conform to the design premise. The installed dry density will for the reference design be at least 1,450 kg/m³, consequently there is a margin of at least 200 kg/m³.

4.6.3 Substances that may cause harmful buffer degradation or canister corrosion

The backfill material must not contain substances that may cause harmful buffer degradation or canister corrosion. The related backfill properties and design parameters to be determined are:

- backfill property: *material composition*.

No design premises are given from the assessment of the long-term safety. Consequently the conformity of the backfill reference design to this design premise will be verified in the long-term safety assessment.

4.6.4 Maintain barrier functions

The backfill shall maintain its barrier functions and be long-term durable in the environment expected in the repository. The related backfill properties and design parameters to be determined are:

- backfill property: *material composition*,
 - design parameter: *montmorillonite content*,
- backfill property: *installed density*,
 - design parameters: *dry density and water content of backfill components, block, bottom bed and pellet filling portions of the deposition tunnel volume*.

For a selected material the capability of the backfill to maintain the barrier functions will depend on the density. In the final repository it is assumed that material will be transported out from the deposition tunnel. The amount of lost backfill material and the margin between the installed and dimensioning densities will determine the capability of the backfill to maintain the barrier functions. For materials with the reference composition stated in Table 3-1 the margin will be 15–33%, which corresponds to the margin for the reference design in SR-Can.

5 Production of the backfill

In this chapter the production line for the backfill is presented. The production line illustrates and explains how the backfill is produced, installed and inspected applying the reference methods. The level of detail in the described production provides an overview of the reference methods, solutions and equipments.

5.1 Overview

5.1.1 Design premises for the development of methods for the production

In this section the design premises for the development of methods for the production and inspection of the backfill are given. *The design premises are written in italics.*

The design parameters of the manufactured blocks, pellets, bottom bed material and the installed backfill shall lie within the acceptable limits specified for the reference design in Sections 3.1 and 3.2. In addition the design considerations presented in Section 2.2.3 shall be kept in mind when developing the methods, i.e. systems and processes, for manufacturing, installation, test and inspection of the backfill. The resulting design premises for the development of methods are compiled in Table 5-1.

Avoiding retrieval of installed backfill (frequency of 10^{-3} or less in Table 5-1) is also a consequence of SKB's objective to minimise the potential radiation doses during the operation of the KBS-3 repository facility.

5.1.2 The production line for the backfill

The production line for the backfill comprises the following three main parts, see Figure 5-1:

- excavation and delivery,
- manufacturing of blocks, pellets and bottom bed material,
- handling and installation.

The backfill production line is illustrated in Figure 5-1, from the material delivery (to the left) to the installation in the deposition tunnel (to the right). The figure also includes a flow chart for the production line with references to the illustrated stages and the sections in which they are presented.

5.1.3 Reference methods for manufacturing and installation

With respect to the requirements on the production the reference methods for manufacturing of blocks, pellets and bottom bed material shall be based on established technique from similar industrial applications. The excavation, delivery and storage of the material follow generally applied procedures. The reference method for manufacturing of backfill blocks is uniaxial compression of individual blocks while the pellets are made with roller compaction. SKB has customised and tested these conventional methods so they result in backfill components that conform to the reference design.

The reference method for installation of the backfill is closely related to and an integrated part of the reference design of the backfill. The reference method for installation of blocks is the "block method", which implies individual placement of each block with a block installer. The reference method for installation of the bottom bed is to use a screw feeder and a compaction equipment to compact the material. The reference method for installation of the pellets around the blocks is to eject the pellets with dry spraying equipment. In the reference procedure the deposition tunnel is backfilled section by section. Since the vehicles used for the installation must not load the bottom bed, the length of each section is determined by the reach of the block installation equipment.

Table 5-1. Design premises for the development of methods for manufacturing, installation, test and inspection.

Design consideration	Required capability of method/production	Design premise
<i>The design and methods for preparation, installation, test and inspection shall be based on well-tried or tested technique.</i>	<i>The methods for manufacturing, installation, test and inspection of the backfill shall as far as possible be based on experiences and established practice from similar applications.</i>	–
	<i>If there is a lack of experiences the reliability of the methods shall be tested and demonstrated.</i>	–
<i>Backfill with specified properties shall be possible to prepare and install with high reliability.</i>	<i>The combination of the geometrical configuration of the backfill material and the installation technique shall be such that the seepage into the deposition tunnels and the resulting hydraulic processes that take place during installation do not impair the barrier functions of the backfill.</i>	<i>The backfill shall yield the required properties given the accepted inflow in deposition tunnels according to Section 2.3.3.</i>
	<i>Methods used in the manufacturing shall, when applied at the repository facility result in backfill pellets and blocks with acceptable properties.</i>	<i>Reference design according to Sections 3.1 and 3.2.</i>
	<i>The rejection frequency of prepared backfill material and components shall be low.</i>	–
	<i>Methods used for testing shall have an accuracy of measurement that lies well within the acceptable variations of the property to be inspected.</i>	<i>Reference design according to Sections 3.1 and 3.2.</i>
	<i>The frequency of the event: "Retrieval of installed backfill in a tunnel section or a whole deposition tunnel after installation." shall be low.</i>	<i>Frequency 10⁻³ or less per deposition tunnel.</i>
<i>The backfill and methods for manufacturing, installation, test and inspection shall be cost-effective.</i> <i>Backfill installation shall be possible to perform in the prescribed rate.</i>	<i>The backfill installation rate shall be adapted to the required canister deposition rate.</i>	<i>A tunnel length corresponding to the average distance between deposition holes shall be backfilled per working day.</i> <i>Based on:</i> <i>A canister deposition rate of 200 per year corresponding to one per working day.</i> <i>The reference sequence for deposition of canister and buffer and installation of backfill see Repository production report, Section 4.1.4.</i>

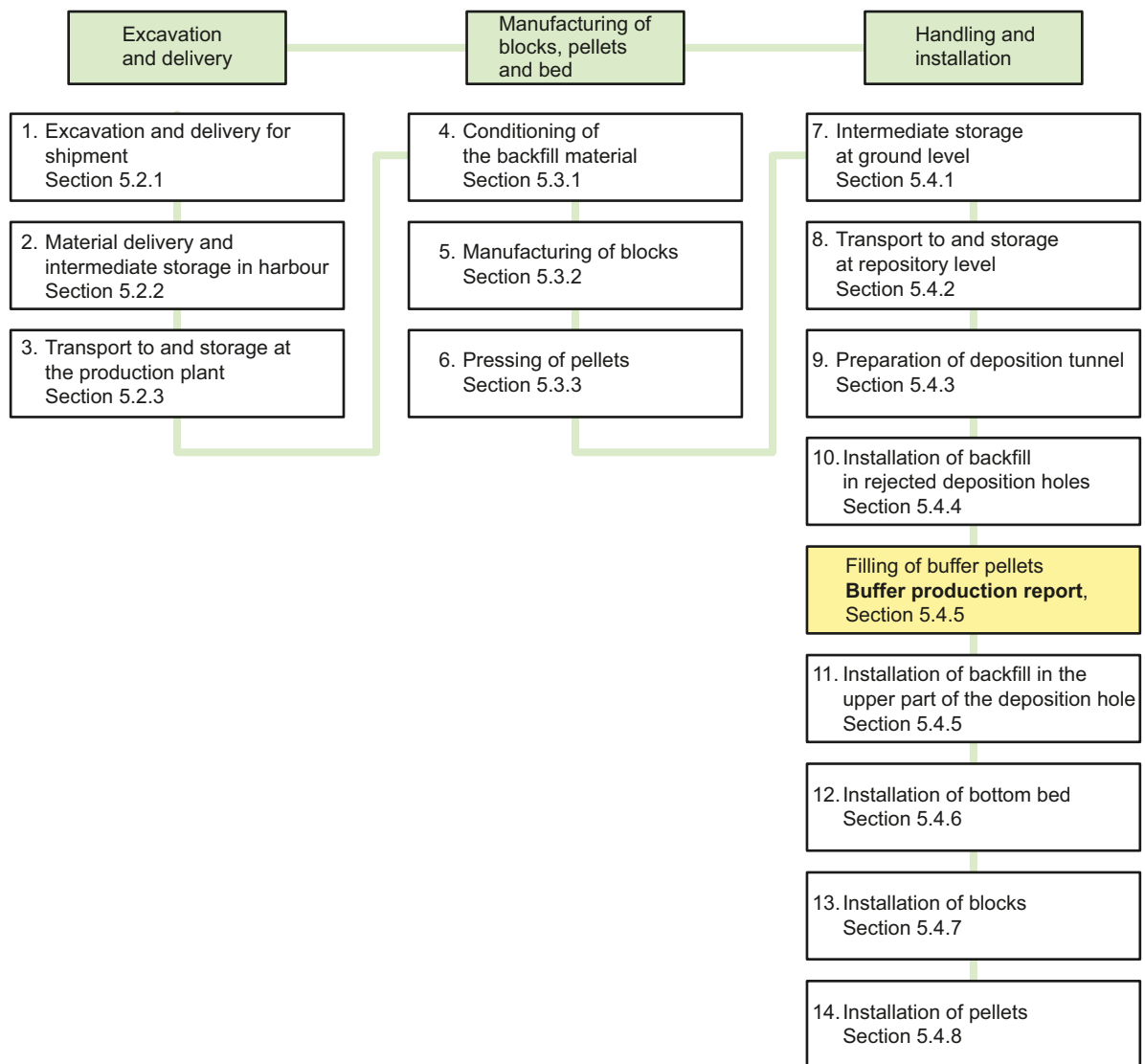
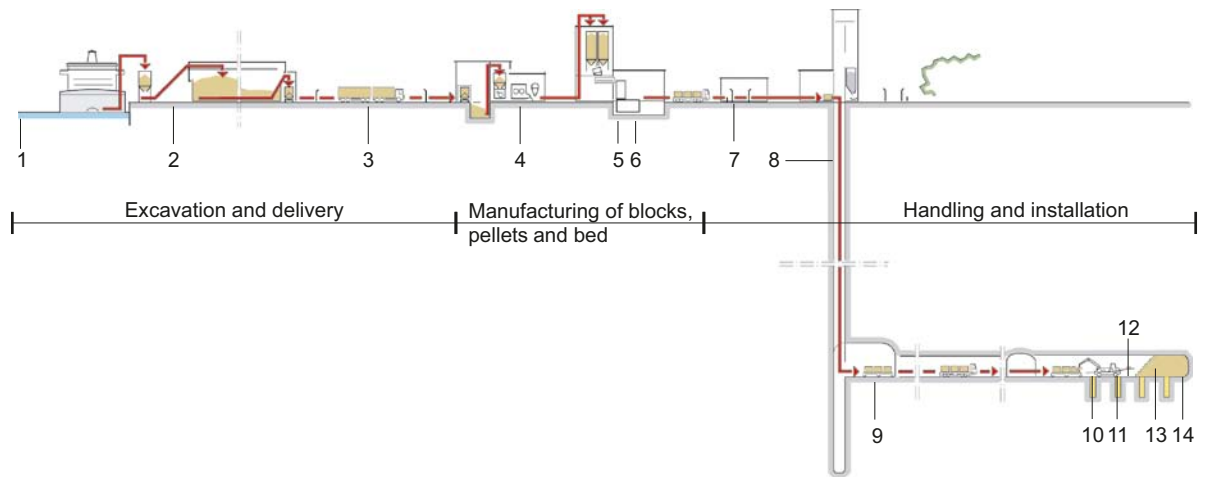

Figure 5-1. Upper panel: Illustration of the backfill production line from the delivery of the material to the installation in the deposition tunnel. Lower panel: Flow chart for the backfill production line including references to the illustrated stages and sections in the text.

In the Bentonite Laboratory and in Äspö HRL the installation of blocks, pellets and bottom bed has been developed and tested. In addition the block method has been investigated by SKB during the last couple of years /Wimelius and Pusch 2008/.

5.1.4 Reference strategy and methods for test and inspection

With respect to the requirements on the production the purpose of the tests and inspections performed at the different stages of the production line are to:

- to warrant that the production result in backfill with acceptable properties,
- achieve a reliable and cost-effective production with low rejection frequency.

The tests and inspections to be performed, the number of inspections and the spatial distribution of the sampling will depend on a number of factors. Examples of such factors are:

- the selected supplier and the character of the bentonite deposit,
- the properties to be inspected,
- the accuracy of measurement and reliability of the applied methods,
- required information e.g. mean or extreme values or variation in time or space,
- the purpose of the test, e.g. input to control a process stage or final inspection of a property,
- available information and experiences, e.g. reliability of the supplier, results from previous deliveries or process stage,
- the available time to perform the inspections with respect to the desired production capacity.

These factors need to be considered when developing a plan for inspections of the backfill. Such a plan shall comprise the parameters to be inspected, the methods to be applied, a strategy for sampling including the number and volume of samples and their distribution in time and space. SKB intend to develop such a plan for inspections as a part of the quality assurance of the backfill.

The methods for test and inspection shall be based on established technique from similar industrial applications. Their accuracy of measurement shall lie within the acceptable variations of the property to be inspected. Generally conventional technique and equipment with sufficient accuracy of measurement is available.

5.1.5 The design parameters and process schemes

The design parameters are the parameters that in Sections 3.1 and 3.2 (Table 3-1, Table 3-3, Table 3-4, Table 3-5, Figure 3-1 and Figure 3-2) were used to specify the reference design of the backfill. These parameters shall, directly or indirectly, be measured during the production of the backfill to verify that the produced backfill conform to the reference design. The outcome of the design parameters need to be known for the initial state. The properties required with respect to the long-term safety and the production (Section 2.3), design parameters and parameters measured in the production and their relations are presented in Table 5-2.

To give an overview of the production, *production-inspection schemes* illustrating the main parts of the production and their included stages are established. For each illustrated stage the design parameters and the processes performed to alter and/or inspect them are presented. Details about the production processes are given in the text about each stage. The text about each stage also includes a presentation of the inspections performed within the stage. The methods for test and inspection are presented separately for each main part of the production. The production-inspection scheme for the excavation, delivery and manufacturing of blocks and pellets is shown in Figure 5-2 and the production-inspection scheme for the handling and installation of the backfill is given in Figure 5-3.

Table 5-2. Backfill – required properties and related design parameters and parameters inspected in the production.

Required property	Design parameter	Parameter inspected in the production
Material composition	Montmorillonite content	X-ray diffraction pattern
Compaction properties of material ready for compaction	Granule size distribution	Sieving curve
	Water content	Weight before and after drying
Density and dimensions of blocks	Dry density ¹	Weight and dimensions
	Dimensions	Height, length and width (H x L x W)
Density and dimensions of pellets	Dry density separate pellets ¹	Weight and dimensions of separate pellet
	Dimensions separate pellets	Thickness, length and width of separate pellet (T x L x W)
	Dry density loose filling ¹	Weight and volume of loose material
Installed density – upper part of the deposition hole	Dry density of buffer blocks ^{1,3}	Weight and dimensions of blocks
	Dry density of pellets ¹	Weight of loose material
	Buffer block and pellet part of volume	Geometry of deposition hole ² Geometry of installed buffer ³ Positions of installed blocks
Installed density – deposition tunnel	Bottom bed thickness	Geometry of deposition tunnel ² Geometry of deposition tunnel after installation of the bottom bed
	Bottom bed inclination	Geometry of deposition tunnel after installation of the bottom bed
	Dry density compacted bed ¹	Weight of loose material Geometry of deposition tunnel ² Geometry of deposition tunnel after installation of the bottom bed
	Dry density of blocks ¹	Weight and dimensions of blocks
	Block part of tunnel volume	Geometry of deposition tunnel ² Geometry of deposition tunnel after installation of the blocks
	Dry density of pellets ¹	Weight of loose material
	Pellet part of tunnel volume	Geometry of deposition tunnel ² Block part of tunnel volume

¹ Water content as determined for material ready for compaction.

² From the **Underground openings construction report**.

³ From the **Buffer production report**.

In the production-inspection schemes the stages where the design parameters are processed are marked with blue colour. Light blue is used for any processing of design parameters and darker blue is used for processes that finally determine one or several design parameters. Determining a parameter means that the parameter is determined within the stage and that no active efforts are, or can be, made to alter it in the following stages of the production.

For the tests and inspections orange colour is used. Lighter colour is used for any inspections of the design parameters during the production and darker orange is used for final test and inspections. After final inspection no further inspections are performed.

Stages where the design parameters are not processed but can be affected are marked with grey colour. Grey colour is also used for inspections of conditions that may impact the design parameters.

		5.2 Excavation and delivery			5.3 Manufacturing of blocks and pellets	
Property	Design parameter	Excavation and delivery for shipment	Material delivery and intermediate storage	Transport to and storage at production plant	Conditioning of the bentonite	Pressing of blocks / Pressing of pellets
Material composition	Montmorillonite content	Excavation				
		(By supplier)	X-ray diffraction	–	X-ray diffraction	
Compaction properties	Granule size distribution	Grinding	–	–	Grinding	
		(By supplier)	Sieving	–	Sieving	
	Water content	Drying	Storage	Transport and storage	Mixing	
		(By supplier)	Drying in microwave oven	–	Drying in microwave oven Drying in oven	
Density and dimensions of blocks	Dry density ¹	–	–	–	–	Pressing
		–	–	–	–	Weighing and calliper
	Dimensions	–	–	–	–	Pressing
		–	–	–	–	Calliper
Density and dimension of pellets	Dry density ¹ separate pellets	–	–	–	–	Pressing
		–	–	–	–	Weighing of individual pellets
	Dimensions	–	–	–	–	Pressing
		–	–	–	–	Calliper of individual pellet
	Dry bulk density ¹ of loose filling	–	–	–	–	Pressing
		–	–	–	–	Weighing of defined volume

¹ Water content as material ready for compaction.

Figure 5-2. Production-inspection scheme for the excavation and delivery and manufacturing of backfill blocks, pellets and bottom bed. Blue colour is used for processing of the design parameter and orange for inspection, darker colour illustrate final processing or inspection. Grey colour show stages where the design parameters may be affected but no processing occurs. (Explanations to the colours are also given in text.)

5.4 Handling and installation									
Property	Design parameter	Intermediate storage at ground level	Transport to and storage at repository level	Preparation of deposition tunnel	Installation of backfill material in the deposition hole	Installation of bottom bed	Installation of blocks in deposition tunnel	Installation of pellets in deposition tunnel	
Installed density ¹	Dry density of blocks in deposition holes	Storage	Storage	–	Installation ²				
		Visual inspection of cover and if required weighing	Visual inspection of cover and if required weighing	–	Weighing and calliper ²				
	Pellet part of volume	Storage	Storage	–	Installation	Installation		Installation	
		Visual inspection and if required weighing	Visual inspection and if required weighing	–	Weighing Scanning of deposition hole	Weighing Scanning of deposition tunnel		Weighing	
	Bed thickness	–	–	–	–	–	Installation		
					Scanning of deposition tunnel geometry ¹		Scanning (after installation of bed)		
	Bed inclination	–	–	–	–	–	Installation		
		–	–	–	–	–	Scanning (after installation of bed)		
	Dry density compacted bottom bed	–	–	–	–	–	Installation		
		–	–	–	–	–	Scanning (after installation of bed)		
	Block part of deposition tunnel volume	–	–	–	–	–	–	Installation	
		–	–	–	Measuring of deposition tunnel geometry ¹	Measuring of upper part of deposition hole geometry ^{1,2} (incl. bevelling)	–	Number of blocks in tunnel section Visual inspection of geometry	
–	Free space between blocks and tunnel walls	–	–	–	–	–	Installation		
		–	–	–	–	–	Inspection of geometry		

¹ Calculated from the inspected weights and volumes.

² Described in the **Buffer production report**.

Figure 5-3. Production-inspection scheme for the handling and installation of finished blocks, pellets and bottom bed. Blue colour is used for processing of the design parameter and orange for inspection, darker colour illustrate final processing or inspection. Grey colour show stages where the design parameters may be affected but no processing occurs. (Explanations to the colours are also given in text.)

5.2 Excavation and delivery

5.2.1 Excavation and delivery for shipment

Process

At excavation the montmorillonite content is finally determined. The bentonite material can be mixed and the content homogenised in later stages but no active efforts to alter the material composition are performed.

Bentonite deposits exist at many places around the world and excavation and delivery can be made by alternative companies. The bentonite supplier shall be approved by SKB. The material is specified by SKB at ordering, most probably by selecting a commercial product defined by the supplier. The material for used in the presentation of the backfill production is a low-grade bentonite (low content of smectite group minerals).

The procedure described here is a general. Exactly how the excavation is performed depends on the deposit. The bentonite is excavated from open pits. Before excavation soil layers are removed and the bentonite deposit is fully exposed. Samples are taken from different parts of the deposit to determine the composition of the clay. The clay is excavated and hauled to a processing plant. At the plant the bentonite is segregated by various quality attributes and put into stockpiles. Quality inspectors direct the building and use of these stockpiles to ensure that each batch is kept separate and free of contamination. The bentonite is collected from the stockpiles and mixed, ground and dried so it conforms to the specification given in the order.

Inspections

SKB will develop a routine for qualification of suppliers. This will comprise inspection of the quality assurance measures and systems applied by the supplier as well as laboratory tests of delivered bentonite samples performed by SKB. The tests comprise measurements of material composition as well as investigations of material properties. The bentonite supplier must have a well documented quality management system.

Before each delivery the bentonite is inspected by the supplier. The inspections comprise a set of parameters specified by SKB and are performed applying specified methods. The supplier is also responsible for the inspection of the cargo area before loading, as well as any necessary cleaning of the cargo space.

5.2.2 Material delivery and intermediate storage in harbour

Process

The bentonite is delivered from self-unloading ships to a harbour close to the repository site. If the bentonite is accepted it is unloaded and transported to a storage building. There shall be enough delivered material available not to interrupt the process even if a delivery is not accepted. In the storage building the temperature is kept above 0°C and the humidity regulated so condensation is avoided.

Shipment and storage of clay materials is conventional and commonly applied technique. An example from a self-discharging and loading vessel for a kaolin supply is shown in Figure 5-4.

Inspections

Each shipment of backfill material is followed by a protocol from the supplier that describes the actual composition of the delivered material. The delivered material is inspected by SKB as a basis for the acceptance of the delivery. Inspections for the production comprise measurement of water content and granule size distribution of the delivered material and measurement of its total weight. Inspections of design parameters of importance for the barrier functions of the backfill comprise material composition.



Figure 5-4. A self-discharging and loading vessel at Norske Skog's receiving facility in Halden, Norway.

The material composition, water content and the specific character of the swelling mineral of samples collected from different parts of the delivery are analysed. The inspections aim at verifying that material conforming to the specification is delivered and to estimate the variation in material composition and water content in the cargo. The number of samples depends on the size of the cargo, the deposit, the methods applied by the supplier and experiences from previous deliveries.

5.2.3 Transport to and storage at the production plant

Process

After acceptance the material is transported to the receiving building of the production plant at the repository site by a conventional truck. To avoid wetting and with respect to working conditions the loading area is indoors and provided with controlled ventilation. The storage can be in buildings or silos. The raw material from different shipments is kept separate.

Inspections

Only the material flow is checked in this stage and for this purpose vehicle weighing equipments are placed in the harbour and in the receiving building.

5.2.4 Methods for test and inspection of material composition

X-ray diffraction – montmorillonite content

The mineral identification and quantification is based on X-ray diffraction (XRD) of samples prepared as random powders. The method is based on exposing the sample to very short-wave electromagnetic radiation and analysing the set of interplanar lattice spacings, which are characteristic to each mineral species. The diffraction pattern is analysed by applying computer-based procedures where observed patterns are fit to known lattice parameters of smectite and other minerals in the mixture. The method is described by /Karmland et al. 2006/.

The result from the X-ray diffraction analysis is a list of minerals present in the sample and the contents in weight percent. The accuracy of measurement differs between minerals and also depends on the character of the sample. An estimate of the uncertainty in the method is made from an evaluation of the montmorillonite content in six samples taken from a small volume from the same delivery of Wyoming bentonite /Karmland et al. 2006/. The statistical analysis shows a mean value of 83.5% with a standard deviation of 1.7%. However, to express a more precise value of the uncertainties of the test method for Milos backfill a test programme specifically designed for the evaluation of the accuracy of the X-ray diffraction method will be carried out.

Determination of other material parameters

In addition to the montmorillonite content, the content of other minerals, sulphide, sulphur and organic carbon is measured in the production. Further, the dominating cation composition and cation exchange capacity (CEC) is determined. All these parameters are important material parameters, however their conformity to the specification need not be verified for the initial state. Methods for determination of these material parameters are described in the **Buffer production report**, Section 5.2.4.

5.2.5 Methods for test and inspection of granule size distribution and water content

The granule size of the material is inspected by sieving through a set of nested sieves. This is a conventional procedure to determine the distribution of particles down to a particle size of 75 µm. The accuracy of measurement is sufficient for the purpose.

The water content of the material is inspected by drying samples in an oven at a temperature of 105°C for 24 h and gravimetric determination of the weight loss of the sample. This is a well established and commonly applied method with sufficient accuracy to assure that the water content lies within the acceptable variation of ±2%. If fast answers are required, the drying is performed by heating the sample in an ordinary micro wave oven for 5 minutes.

5.2.6 Experiences and results

Bentonite is a product used worldwide in many industrial applications. Excavation and delivery of bentonite with specified properties are well known and tested techniques and procedures. SKB regards the conventional methods and procedures as reliable.

SKB's experiences are mainly based on deliveries of the commercial bentonite product MX-80 supplied by American Colloid Company. MX-80 has been tested by SKB over the last decades. The tests show that the composition of the bentonite varies very little between different deliveries, see **Buffer production report**, Section 5.2.6.

The material composition of Milos backfill is given in Table 5-3. The performed inspections of Milos Backfill in combination with the experiences gained from deliveries of MX-80 supports that worked out specifications and conventional quality assurance procedures results in a delivered material according to specification.

5.3 Manufacturing of blocks, pellets and bottom bed

5.3.1 Conditioning of the backfill material

Process

In this stage the delivered material is processed to the material specific granule size distribution and water content suitable for pressing blocks and pellets. The granule size distribution and water content of the material ready for compaction are finally determined.

Table 5-3. Material composition of Milos backfill measured on one delivery of this low-grade bentonite product /Olsson and Karnland 2009/.

Parameter	Content in Milos backfill
Montmorillonite (wt%)	58
Cation	Ca
CEC (meq/100 g)	73
Sulphide (%)	0.03
Total sulphur (%)	0.06
Organic carbon (%)	0.38

The conditioning of the material comprises the following activities:

1. drying to a water content suitable for grinding,
2. grinding to a granule size suitable for compaction,
3. storage of ground material,
4. wetting of ground material in mixers to a water content suitable for compaction,
5. storage of material ready for compaction.

If the water content of the delivered material is too high for grinding the material needs to be dried to a water content suitable for grinding. The drying is made in a dryer with a high capacity. After drying the material is transported to a mill and grinded to the required granule size. The grinding is made with a hammer mill and after grinding the material is transported to a silo where it is stored.

In order to get the water content required for pressing of blocks and pellets the ground material is mixed with water in mixers. The adjustment of the water content of the bentonite is made with high efficient mixers. Examples of mixers are the intensive Eirich-type which have capacity for batches of approximately 3.5–4.0 tonnes, see Figure 5-5. A specified amount of ground bentonite material is filled into the mixer, its water content is measured and the amount of water needed to reach the specified water content is calculated. Water is added to the bentonite in the mixer through a spray nozzle. In order to reach the required density and water content when pressing blocks and pellets it is important that the bentonite after the mixing is homogeneous, free from lumps, and that the variation in the water content conforms to that specified for the reference design.

Each mixed batch is after inspection transferred to a production silo in connection to the pressing device. With respect to required capacity the whole conditioning process is automatic and the mixing takes place in two separate lines. Similar production plants are used in pottery industry and have been used by SKB in a small scale for production of blocks and pellets for the backfill material used in field tests.

Inspection

The material composition and the granule size distribution and water content of the material ready for compaction is finally inspected in this stage. The water content of the raw material is also inspected before and after drying to yield a level suitable for grinding.



Figure 5-5. Eirich RV24-type intensive mixer.

The water content and granule size distribution of the material ready for compaction is finally inspected in connection to the mixing. The inspection of the granule size distribution is made after grinding. The water content is inspected before the mixing to determine the amount of water to be added. The amount of water added is measured and finally the water content of the mixed material ready for compaction is inspected. Samples are taken from the batch with mixed material. The inspections are performed by drying in micro-wave oven. The number of samples shall be sufficient to determine the average water content.

The material composition is finally inspected. Samples for determination of the composition are taken from a number of batches and samples are saved as reference. A sampling strategy will be developed as part of an inspection plan, see Section 5.1.4.

5.3.2 Pressing of blocks

Process

In this stage the density and dimensions of the blocks are finally determined. The pressing process is controlled to yield the specified properties.

The reference method for pressing of blocks is uniaxial compaction. The press is characterised by a fixed lower die, a moveable upper die and a moveable mould frame. The movement speeds of the upper die and the mould frame are independent. In this way, the friction between the backfill material and the wall of the mould is reduced and an even density is obtained in the compacted material – even when blocks with large dimensions are manufactured. In Figure 5-6 the principle for the tool movements during the pressing cycle is shown. An accurate tool and correctly adapted press parameters secure a high reproducibility of dimension and density of the blocks. The plan is to have presses suitable for pressing the largest required blocks. These presses are used also for smaller dimensions by installing intermediate walls in the pressing tool. The described technique has been used for production of bentonite blocks of various dimensions. In Figure 5-7 an example of a hydraulic press is shown.

The density of the blocks depends on the granule size distribution and water content of the material to be compressed and on the compaction pressure. The dimensions of the blocks are determined by the dimensions of the mould and the amount of material filled to the mould.

The mass of material filled into the pressing tool must be accurate in order to obtain the required block dimensions. The backfill material is therefore weighed before it is filled into the tool. In order to get homogenous blocks and to avoid air entrapment and lamination problems, the press is fitted with an evacuation device. When the block has been knocked out of the tool, it is placed on a specially designed pallet and transported to a pallet store awaiting further handling. Each pallet with blocks is marked with a unique identity to which information registered for the blocks is linked.

In order to reach the required capacity the plan is to have two presses and an automated process with a system for the control of the filling of the pressing tool, feeder belt and handling of blocks and pallets. The control system for the pressing also includes the storage of production and inspection data.

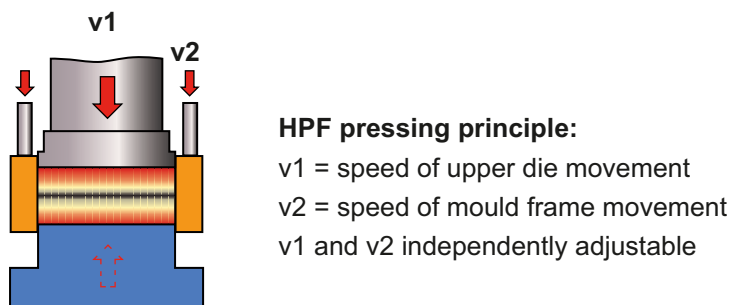

Figure 5-6. Principle for the movements of the pressing tool during pressing of backfill blocks. The principle is called HPF pressing principle by the manufacturer.



Figure 5-7. A Laeis hydraulic press.

Inspection

The density and the dimensions of the pressed blocks are finally inspected in this stage. A strategy for selection of blocks for inspections will be developed as part of an inspection plan, see Section 5.1.4. Selected blocks are visually inspected, weighed and their dimensions are measured and the bulk density of the blocks is calculated. In addition, the dry density of the block is calculated from the water content recorded in the conditioning stage.

5.3.3 Pressing of pellets

In the reference design the same type of pellets are used for the bottom bed, for filling the gap between the blocks and the rock wall in the deposition tunnel and for the upper part of the deposition hole (beveling).

Process

In this stage the density and dimensions of the pellets are finally determined.

The reference method to manufacture pellets is to compact the conditioned material to small briquettes. The pellets can be made in different sizes. The machine pressing the pellets consists of a screw and two rolls, see Figure 5-8. Conditioned backfill material to be pressed to pellets is transported to the pressing machine. The material is compressed by the screw while the rolls rotate. The right roll rotates clockwise and the left anti-clockwise. It is possible to vary the roll speed and the pressure from the screw to change the density of the pellets. After pressing the pellets are placed in specially designed containers which are marked with a unique identity and transported to intermediate storage.

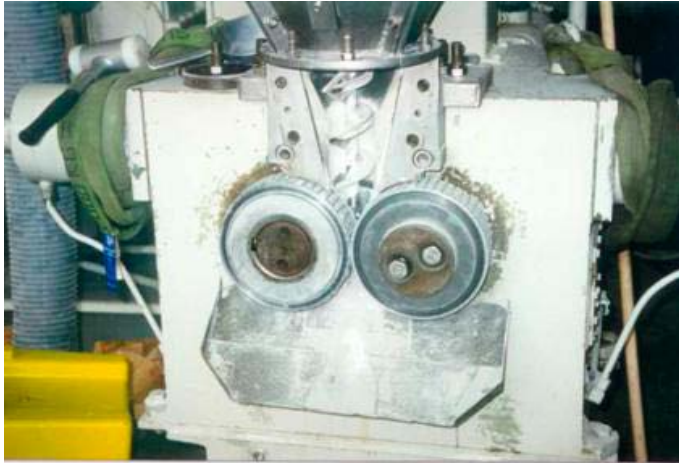

Figure 5-8. A machine for pressing of briquette shaped pellets, BEPEX test equipment.

Inspections

In this stage the bulk density of loose pellet filling and also the density of single pellets are finally inspected. The granule size distributions and water content in the backfill material used for the production of pellets should conform to given specifications, and were inspected in the conditioning stage, see Section 5.3.1.

The weight and volume of an individual pellet is inspected by weighing a number of pellets both in air and in oil with known density. The dry density of the individual pellets is calculated from the recorded water content, weight and volume.

The weight of a loose filling of the pellets is inspected by weighing a filled container with known weight and volume. The bulk density of the loose filling is calculated from the volume and the recorded weight. In addition, the dry density of the loose filling is calculated from the known water content.

A sampling strategy comprising the number of tests and inspections will be developed as part of an inspection plan included in the quality assurance of the backfill.

5.3.4 Methods for test and inspection of material composition

The same methods for test and inspection of the material composition as for the excavation and delivery are applied. The methods and their accuracy in measurement are presented in Section 5.2.4.

5.3.5 Methods for test and inspection of granule size distribution and water content

The same methods for test and inspection of granule size distribution and water content as for the excavation and delivery are applied. The methods and their accuracy in measurement are presented in Section 5.2.5.

5.3.6 Methods for test and inspection of weight, dimensions and density

Different kinds of weighing machines are used for inspection of the weight of the pellets and blocks. The weighing machines are calibrated to the required accuracy by applying conventional procedures. In order to confirm that the dry density lies within the acceptable limits the weight of the blocks (with known water content) should be measured with an accuracy of ± 1 kg. The dry bulk density of loose filling of pellets (with known water content) is directly determined by weighing a defined volume of loose filling. Measuring of weight of objects is established and well known technique.

The measurements of the height, length and width of the blocks are made with a calliper. The dimensions of the blocks can be measured with an accuracy of ± 0.5 mm. Measuring of dimensions of objects of the size of the blocks with the required accuracy is established and well known technique from various similar applications. The dimensions of separate pellets can also be determined with a calliper. The required accuracy is similar as for the blocks and the method is based on well known and established technique.

The assumed accuracy in measured dimensions of ± 0.5 mm results in a volume uncertainty of ± 0.25 and $\pm 0.35\%$ for the larger and smaller blocks respectively. The accuracy in measured weights of ± 1 kg results in an uncertainty in weight of ± 0.25 and $\pm 0.6\%$ for the small and large blocks respectively. Based on the recorded dimensions and weights the accuracy in bulk density is $\pm 0.5\%$ and $\pm 1\%$ for the larger and smaller blocks respectively. This can be compared to the accepted variation in dry density of $1,700 \pm 50$ kg/m³ corresponding to $\pm 3\%$.

The dry densities are calculated from the recorded masses and volumes and the water content determined in the conditioning stage. The accuracy will in addition to the accuracy in bulk density depend on the accuracy of the water content measurements.

5.3.7 Experiences and results

Bentonite blocks have been pressed at laboratory scale using a number of materials including Milos backfill. In the laboratory scale tests, two different compaction pressures (25 and 50 MPa) and multiple water contents were used in order to determine the optimum water content and maximum dry density for the blocks /Johannesson and Nilsson 2006/. The data provided in Figure 5-9 shows the sensitivity of each of these materials to minor changes in water content. In general, small variations in water content do not result in substantial change in the achievable block density. However, the plots do illustrate the differences in the compactability of different clay materials. Hence water content, grain size distribution and load specifications for the production will need to consider the properties of the selected material. Possibly minor adjustments may also be made for different material deliveries.

In total approximately 15,000 small scale blocks have been manufactured for different tests performed by SKB. These small scale blocks have been manufactured at Höganäs Bjuv AB in Bjuv. The press is smaller but of similar type as the one described in Section 5.3.2. Both Friedland and IBECO-RWC-BF have been used in the manufacturing.

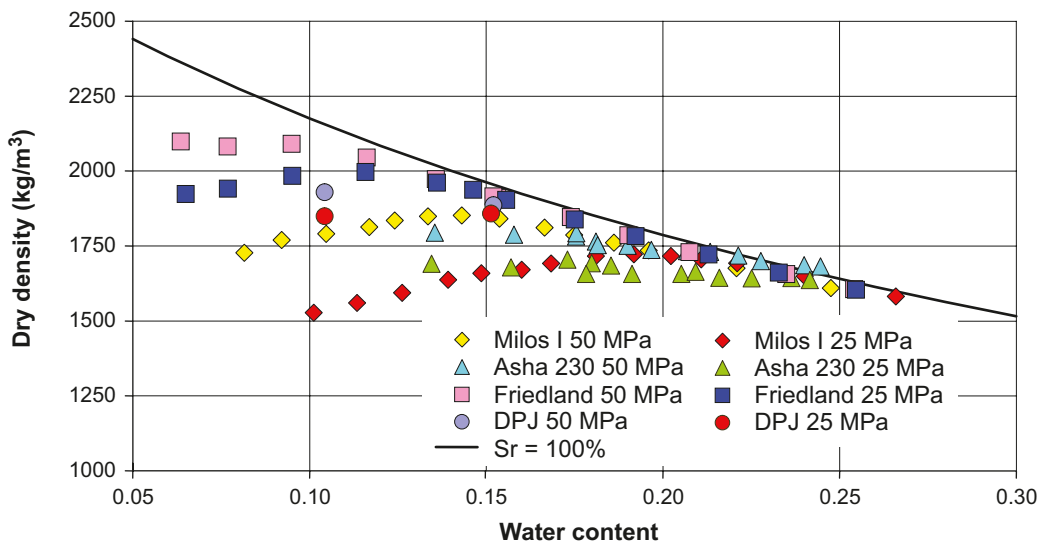

Figure 5-9. Dry density plotted as function of water content for three clays compacted at two different compaction pressures (50 and 25 MPa).

In total 7,500 small scale blocks have been pressed at Bjuv with IBECO-RWC-BF. An investigation of these blocks with the purpose to determine the variation of the density both within a block and between blocks have been performed. The results from this investigation shows that the produced blocks are very homogeneous and that the variation in density between the blocks is very small /Johannesson et al. 2010/.

Blocks measuring 300×300×150 mm have been pressed at Alpha Ceramics in Aachen at several occasions using Friedland material and IBECO-RWC-BF. A test series of 36 blocks have been pressed using IBECO-RWC-BF with a water content of 19%. Each block was measured and weighed, the results are provided in Table 5-4.

The blocks will expand slightly immediately after they have been taken out from the mould (elastic rebound of clay). This is the reason why the dimensions of the blocks reported in Table 5-4 is greater than 300×300×150 mm. The results show that there are very low spread in dimensions, which means that this behaviour can be compensated for by an adjustment of the size of the mould with 1–2 mm so that the final size will conform to the specified dimensions.

Even though block manufacturing has not been performed with Milos backfill at the reference block size, the ranges of size and density given in Table 5-4 are within the accepted variations given in the reference design for backfill.

Block manufacturing has been performed with different materials and block sizes without any significant variations in the results. The conclusion is that pressing of blocks from bentonite material is a well-tried and reliable method. The results depend on a number of adjustable parameters, and the pressing process must be adjusted to the press and material in order to ensure a reliable process delivering blocks within the accepted tolerances.

The technique for pressing of pellets has been tested at two suppliers of equipment for this type of production namely BEPEX-Hoskawas in Germany and Sahut-Conreur S:A: in France. The technique is well known from other industrial applications and has been used for production of pellets for the field tests in Äspö HRL.

5.4 Handling and installation

5.4.1 Intermediate storage at ground level

Process

Backfill blocks and pellets are stored at the ground level awaiting transport to the repository level. Stores are planned to be placed in the production building in the industrial area of the final repository facility and in the skip building within the protected area of the nuclear facility. Handling and transports above ground are made by conventional overhead cranes, grapple units and load carriers. In case of breaks in the production of blocks and pellets, a stock on the surface is needed to avoid interruptions in the installation of the backfill.

Table 5-4. Experiences from block manufacturing in Aachen using IBECO-RWC-BF.

Length (mm)			Width (mm)			Height (mm)			Dry density (kg/m ³)		
Mean	95% C.I.		Mean	95% C.I.		Mean	95% C.I.		Mean	95% C.I.	
302	301.99	302.01	302	301.99	302.01	150.3	150.15	150.54	1,620	1,617	1,624

The properties of blocks and pellets must not be altered during handling and transport. The shape of the blocks must not be altered and they must not be exposed to shocks that create fractures. It is important that the water content of the blocks and pellets is not changed during the storage. For this purpose the blocks are placed on special designed pallets, see Figure 5-10, equipped with a diffusion tight plastic cover with low pressure inside. The pellets are stored in diffusion tight containers. Since the storage time is short, a few days, there is no need for more advanced covers.

Inspections

Before the pallets are transported from the storage to repository depth the identity, covers, blocks and pellets are visually inspected. If the covers are damaged or there are any visible damages on the blocks or pellets, they are either discarded or the inspections of their weight and dimensions are repeated.

5.4.2 Transport to and storage at repository level

Process

The backfill material is transported to repository level with the skip. To achieve the prescribed installation rate totally about 40 pallets with blocks and about 15 containers with pellets need to be transported daily.

The pallets with blocks and containers with pellets are intermediately stored in a central storage below ground.

In the intermediate storage location the blocks are reloaded to a transport vehicle that delivers blocks to the backfilling machine in the deposition tunnel. The pellets are transported in their special containers to the deposition tunnel for installation. Alternatively they are filled into units suitable for the installation equipments used for filling of the upper part of the deposition hole, installation of the bottom bed and the filling of the gap between the blocks and the rock wall, respectively.

Inspections

The same inspections as for the interim storage on ground level described in Section 5.4.1 are performed before the blocks and pellets are transported to the deposition tunnel for installation.



Figure 5-10. Backfill blocks placed on a special designed pallet.

5.4.3 Preparation of deposition tunnel

The installation of the backfill is based on that deposition tunnels according to specification are provided from the underground openings production line. The preparation of deposition tunnels is described in the **Underground openings construction report**, Section 5.2.6 and shall comprise the following stages.

- The rock walls of the tunnel shall be inspected and scaling and rock bolting executed if necessary.
- Roof bolts that reach inside the nominal cross section of the tunnel shall be cut behind the washer.
- The tunnel shall be cleaned and emptied of equipment from earlier activities.
- The tunnel bottom shall be cleaned from gravel and other materials and inspected.
- The inflow to the tunnel shall be inspected.
- Scanning of the rock walls shall be carried out to determine the tunnel volume, the tunnel contour and the geometry of the bevel.
- Temporary ventilation, electric supplies and lighting shall be installed in the tunnel.

With regards to exhaust fumes and dust from the installation of pellets it is important that the tunnel is well ventilated. With respect to water inflow and to keep the probability of retrieval of installed backfill low an emergency back-up system for the electricity supply to the activities may be required.

5.4.4 Installation of backfill in rejected deposition holes

Before the installation of the backfill in deposition tunnels proceeds, potentially occurring rejected deposition holes are backfilled. The material and technique for this will be determined before the deposition of canisters commences, and can be similar as for the buffer or backfill.

5.4.5 Installation of backfill in the upper part of the deposition hole

If there are deposition holes in the section of the tunnel to be backfilled, the installation of the buffer must be finished (see the **Buffer production report**, Section 5.4.5) and the upper part of the deposition hole backfilled before the installation of bottom bed, blocks and pellets commences. The parts of the deposition hole filled with backfill and buffer respectively are illustrated in Figure 5-11. The two top blocks in the deposition hole are part of the backfill. However, in the current reference design they are made of the same material as the buffer and they are deposited at the same time as the buffer, see **Buffer production report**, Section 5.4.4.

Process

In this stage the installed density of the backfill in the upper part of the deposition hole is determined.

The bevelled part of the deposition hole (see Figure 5-11) is filled with the same type of pellets as used in the tunnel. The pellets filling is compacted to a density sufficient to prevent settlements of the backfill blocks in the tunnel.

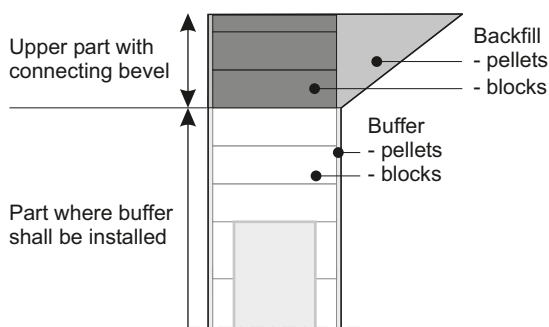

Figure 5-11. Backfill in the upper part of the deposition hole.

Inspections

Before the pellets are installed, the rock surface is scanned and the volume of the bevel is calculated. Further, the identity of the pellets filling is inspected. The weight of the pellets installed in the bevel is finally inspected. This is done by weighing the container with pellets to be installed before and after the installation. The difference in weight, i.e. the installed pellet mass, is recorded.

The installed bulk density of the pellet filling in the bevel is calculated from the recorded installed pellet mass and the calculated bevel volume. Based on the water content known from the pellet identity the average dry density is determined from the bulk density.

5.4.6 Installation of bottom bed

To make it possible to stack the backfill blocks to the specified geometry the tunnel floor need to be flat and have sufficient bearing capacity. A bottom bed is installed to achieve this.

Process

In this stage the installed density, inclination and bearing capacity of the bottom bed are determined.

The installation of the bottom bed pellets is performed by a screw feeder. In addition, the bed has to be compacted and the flatness of the surface adjusted, this is performed by a vibratory plate, see Figure 5-12.

Inspections

Before the material is installed the rock surface, and the surface of possibly occurring backfilled deposition holes in the section is scanned, and the volume of the actual section of the deposition tunnel calculated. The identity of the pellets filling is inspected and the weight of the installed pellets is recorded during the installation. After compaction and final adjustment of the bed the volume of the tunnel is scanned again, and the volume of the bottom bed is calculated. From the recorded mass and volumes the installed bulk density of the bottom bed is calculated. The installed dry density of the bottom bed is then calculated for the known water content. The inclination and evenness of the bottom bed is inspected by surface scanning.

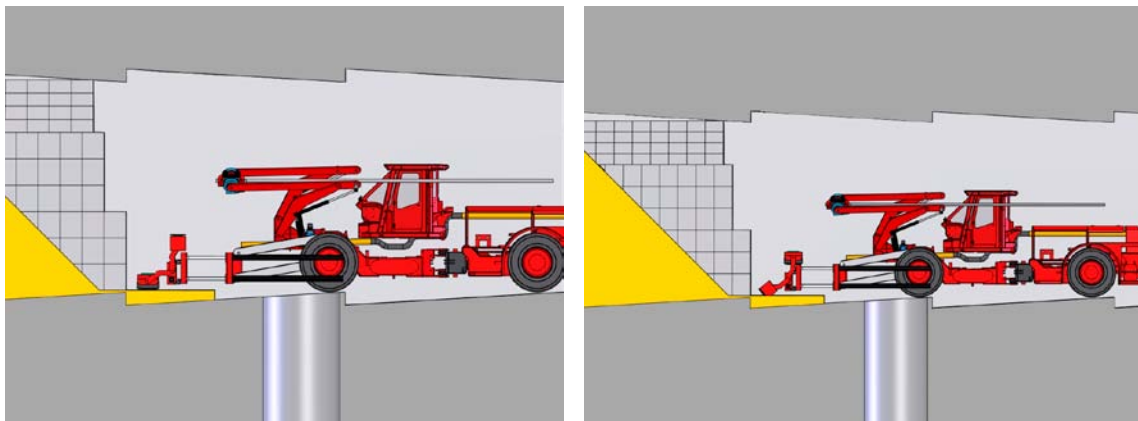

Figure 5-12. Installation, compaction (left) and adjustment (right) of the bottom bed.

5.4.7 Installation of blocks

Process

In this stage the block part of the actual deposition tunnel section volume is determined.

To follow the contour of the tunnel two sizes of backfill blocks are used. An example of how block placement may be carried out is illustrated in Figure 5-13. The backfill blocks are placed on a conveyor that brings the blocks to a position where the lifting tool grabs the blocks and lifts them into their position in the tunnel. The blocks are installed one by one from side to side of the deposition tunnel until a complete vertical layer is installed.

Inspections

In this stage the block part of the currently backfilled section of the deposition tunnel is finally inspected. This is done by determining the number of blocks with different sizes installed in the section, calculating their total volume and compare it to the tunnel volume scanned before the installation was initiated. Further, after the installation of each layer of blocks, the evenness of the layer is visually inspected. It is also checked that the distance between the blocks and rock walls is at least 10 cm.

5.4.8 Installation of pellets

Process

In this stage the weight of the pellets filling between the backfill blocks and the rock surface is determined.

With respect to the installed backfill density free filling of pellets is sufficient. The reference method is to use dry spraying equipment. To prevent dust small amounts of water may be added during the installation of the pellets. The installation equipment comprises a carrier with a beam in the front that can be rotated and folded in different positions. Mounted in front of the beam is a lance with a tube. The dimension of the tube is chosen to reach into the narrow space between the blocks and the rock and to have capacity to yield the prescribed installation rate. In Figure 5-14 an illustration of the equipment used for pellets installation is shown.

Inspections

The installed weight of pellets in the open space is registered during installation. If water is added during the installation the volume/weight is also recorded.

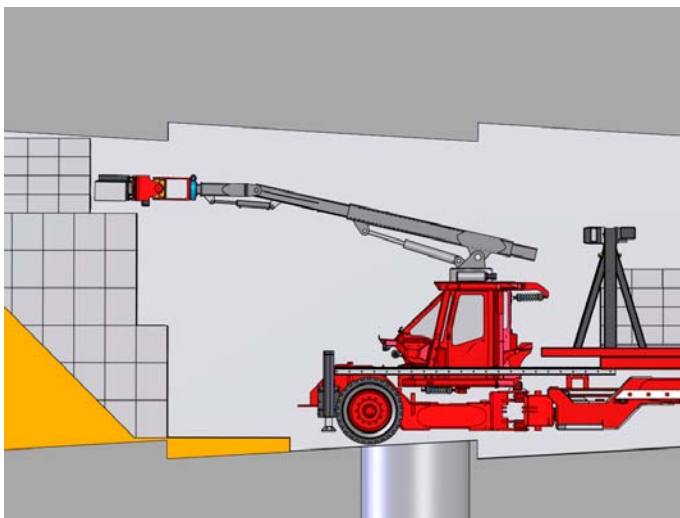

Figure 5-13. Figure illustrating the positioning of blocks.

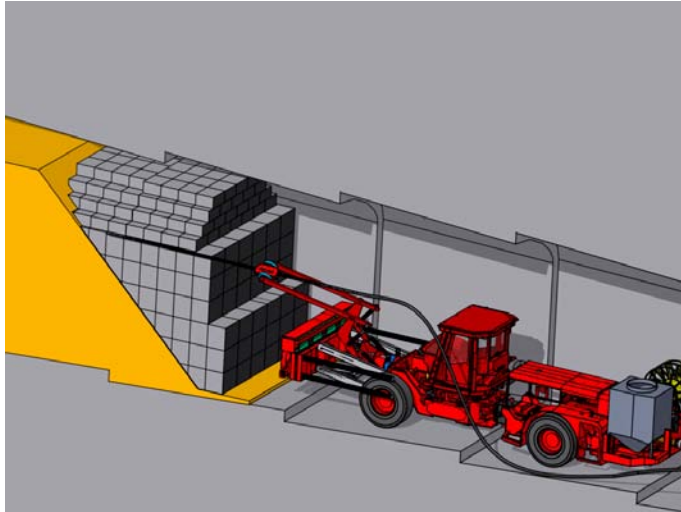

Figure 5-14. Installation of pellets using the bed/pellets unit.

The filling degree is visually inspected with a camera mounted at the front of the feeding device. Directly connected to the camera (around the lens) a concentrated lamp is mounted for illumination purposes. When the operator aims the lance towards the rock, a picture of the edges of the blocks and previously installed pellets filling, is shown on a display. This is of great help during the installation.

If required it is possible to determine the installed density in the actual tunnel section. To do this either the volume must be scanned after installation of the pellets or the surface of the pellets filling front has to be vertical. The installed density in the tunnel section can be calculated from the previously determined density of the bottom bed, the number and weight of the blocks, the weight of the installed pellets and the tunnel volume scanned after installation of the bottom bed, and possibly also after installation of the pellets filling.

When the backfilling reaches the final section in the deposition tunnel the installed bulk density in the deposition tunnel is calculated from the densities of the backfill in the deposition holes and bottom bed, the summed up volumes of the tunnel sections scanned after deposition of the bed, the number and weights of the blocks and the recorded weights of pellets filling. The installed dry density can be calculated from the water content of the blocks and pellets which is documented together with the identity of the blocks and pellets.

5.4.9 Methods for inspection of weight, dimensions and density of blocks and pellets

In this stage blocks on pallets where the cover has been damaged may be weighed. The methods described in Section 5.3.6 are applied.

5.4.10 Methods for inspection of installed density

The installed backfill density and its variation in the deposition tunnel volume are calculated from measured weights and geometries/dimensions. The weight and dimensions of the blocks is recorded in connection to the pressing, see Section 5.3.2. The weight of the pellets is recorded during the installation. The methods for weighing are described in Section 5.3.6.

The deposition tunnel volume before the installation commences is provided from the **Underground openings construction report**, Section 5.2.2 and Appendix A. The volume after installation of the bottom bed is scanned by applying the same method.

The installed density is calculated by software to which the measured data is directly recorded and interpreted. The accuracy of the calculated installed density depends on the accuracy of the recorded masses and volumes.

5.4.11 Experiences and results

Installation of bottom bed

Medium and large scale tests have been performed to test available techniques for handling of the bentonite pellets/granules and compaction technique to get a stable bed, and also to test the performance of an installed bed i.e. when the bed was loaded with backfill blocks (settlements etc) and there was a water flow from the rock /Wimelius and Pusch 2008/. The tests were performed with two bentonite materials, Minelco granules and Cebogel pellets. The large scale tests were performed in an artificial tunnel using concrete blocks instead of bentonite blocks since the main focus was on the installation and behaviour of the bottom bed. One test with bentonite blocks in direct contact with the bottom bed was performed to investigate if the block material influenced the results. This test showed that the results were independent of the block material (bentonite or concrete).

The bentonite material should be compacted to a high degree of homogeneity and to a sufficiently high density in order to cause insignificant settlement of the block masonries that will be placed on the bed. In the tests this was best done with 4 runs of a 150 kg vibratory plate.

The dry density after compaction was for the Minelco bed about 1,250 kg/m³ and for the Cebogel bed about 1,150 kg/m³. In summary, none of the bed materials jeopardises the stability of blocks stacks if it is placed before water flows in along the floor. A practical matter is that the bearing capacity of the Minelco bed at inflow of water is higher than for the Cebogel bed since it retains its stability for a longer time than the Cebogel material under wet conditions. Effective and uniform compaction makes the beds sustain spot-wise water inflow of 1 litre per minute without early collapse /Wimelius and Pusch 2008/. This result is only valid for this specific test set up, for other test set ups other water inflows applies. Specific inflow requirements for this part of the operation remain to be determined. In most of the tests, the water rose upwards through the bentonite below the blocks against the not loaded surfaces, and then up on the surface, and forward in front of the pile. This means that the main part of the wetting was done from above. The buffering of water below the blocks was low which probably depends on the pressure from the backfill blocks, which makes the water run in other directions.

The material is handled and placed using standard equipment. The placement capacity in performed tests was estimated to be 900 kg/5 minutes. For a final thickness of the layer after compaction of 0.3 metres, this means that it takes about one hour to install the bed in a tunnel section with a length of 6 metres and an average width of 4.5 metres.

Levelling of the material with a standard ladle equipped with laser was also tested. The time was estimated to about 30 s/m². The accuracy of the levelling was between +5 to -20 mm. The evenness of the surface must be improved in order to stack backfill blocks in an acceptable way.



Figure 5-15. After removal of the blocks large dry areas were seen.

Installation of backfill in the upper part of the deposition hole

The upper part of the deposition hole is filled with buffer blocks installed at the same time as the buffer, see **Buffer production report**, Section 5.4.4. A method to backfill the bevel has been tested at Äspö HRL. The basic concept in these tests has been to install bentonite material in form of granules or pellets and compact it manually with vibratory plate and an electrically powered jumping jack device.

Tests without compaction were also performed, the conclusion from these tests was that compaction is required.

The results indicated that it is possible to compact the used bentonite material (Minelco granules and Cebogel pellets) to dry densities between 1,029 and 1,208 kg/m³ which is sufficient to avoid settlements during block installation.

Installation of blocks

Stacking tests have been performed at the Äspö HRL /Wimelius and Pusch 2008/, see Figure 5-17. They have provided a lot of useful information on the capacity, stability and need for technology to conform to the required accuracy during installation. The tests have been performed at different water flows from the floor and on different bed materials. The results have also indicated the various preconditions that follow from different materials and flows.



Figure 5-16. Backfilling of bevel at Äspö HRL



Figure 5-17. A stacking test being performed on a bentonite bed with a water inflow.

The assessment after tests and studies is that the method is feasible but that it is dependent on advanced technology. The vacuum technique for lifting blocks needs to be tested more as well as the quality of the blocks in handling. In order to conform to the design premise to backfill a length corresponding to the average distance between deposition holes per day and considering the time consumption for other activities, the blocks have to be stacked within 60 seconds. In the tests this has been proven possible, but it presupposes that installation checking is frequently approved and that the water inflows do not affect the blocks until the pellets have been installed.

In order to support the conclusions and verify the performance of the technology, further full scale tests with pressed bentonite blocks will be performed.

Installation of pellets

Several techniques for installing the pellets have been investigated and are possible to use. The installation must yield a good filling of irregularities that occur mainly in the rock contour.

A large number of full scale tests have been performed in the Bentonite Laboratory at Äspö /Wimelius and Pusch 2008/, a photo from one of the tests with the reference equipment is shown in Figure 5-18.

The tests that have been performed show that the selected method is feasible. The installation capacity is according to the tests approximately 5 m³/h, but can probably be improved.

The intended dry density of a pellet fill was 1,000 kg/m³ (Cebogel pellets with 16% water content). However, the dry density of the installed pellets filling was found to be 907 kg/m³. This may partly be explained by the fact that the space immediately below some of the artificial rock outcrops was not filled. In tests done at ½-tunnel scale pellets were successfully installed into a 150 mm wide gap to a dry density of 980–1,080 kg/m³ but there were no irregularities in the gap, which simplified the process /Keto et al. 2009/. The higher density achieved in these tests indicates that there is room for improving the achieved dry density of the pellets installed in a repository environment. Further trials will be undertaken to determine the practically achievable installed pellet density.

Regarding filling of the whole space between blocks and the rock walls it was also concluded that although the pellets filling was in contact with the tunnel roof it undergoes some self-compaction, leading to a gap that will remain open until the filling is saturated with water and swells into any adjacent openings.



Figure 5-18. Pellet installation test with the reference equipment, at the Bentonite Laboratory at Äspö.

6 Initial state of the backfill

The initial state refers to the properties of the engineered barriers once they have been finally placed in the final repository and will not be further handled within the repository facility. The initial state of the backfill is the state when the entire deposition tunnel is backfilled. Inflow of groundwater to the deposition tunnel and its impact on the backfill is not accounted for in the initial state.

For the assessment of the long-term safety it shall be confirmed that the backfill at the initial state conform to the design premises related to the barrier functions in the final repository. The confirmation shall be made through verification of:

- the conformity of the reference design to the design premises,
- the conformity of the installed backfill to the reference design.

The conformity of the reference design to the design premises was verified in Chapter 4 and the results are summarised in Section 4.6. In this chapter the initial state of the backfill and its conformity to the reference design is presented. This chapter also comprise conclusions regarding the conformity of the installed backfill to the design premises stated in **Design premises long-term safety**.

6.1 Initial state and conformity to the reference design

In this section the initial state of the backfill is presented and the conformity of the manufactured backfill components and installed backfill to the specification given for the reference design is discussed.

6.1.1 Initial state

At this stage of development, the presented initial state of the backfill is the outcome of the design parameters that can be expected based on the experiences and results from the test production presented in Chapter 5 (Sections 5.2.6, 5.3.7 and 5.4.11).

In Table 6-1 initial state values for the design parameters that in Sections 3.1 and 3.2 were identified as important for the conformity to the design premises stated in **Design premises long-term safety** are presented. For each design parameter reference design and initial state values are given. The table also include comments and references to the sections where the experiences from the production are compiled and sections where the presented initial state values are discussed and justified.

Table 6-1. The backfill design parameters at the initial state and references to the sections where the experiences that supports the conformity of the produced backfill to the reference design are presented.

Design parameter	Reference design	Initial state	Comment and reference to relevant sections
Material composition			
Montmorillonite content	45–90 wt-%	45–65 wt-%	See Sections 5.2.6 and 6.1.2
Density of blocks and pellets			
Dry density of blocks			See Sections 5.3.7, 5.4.11 and 6.1.3
– tunnel section	1,700 ± 50 kg/m ³	1,700 ± 50 kg/m ³	
– upper part of deposition hole	1,710 ± 17 kg/m ³	1,710 ± 17 kg/m ³	
Dry density of pellet filling	1,000 ± 100 kg/m ³	1,000 ± 100 kg/m ³	
Dry density of compacted bottom bed	> 1,200 kg/m ³	> 1,200 kg/m ³	
Installed geometry			
Block part of tunnel volume	Nominal: see Figure 3-2 Accepted: ≥ 60%	Average: 74.1% Min 67.3% and max 78.7%	See Sections 5.4.11 and 6.1.4

The conformity of the design parameters stated in Table 6-1 to the reference design shall be verified for the initial state. In addition to the material parameters included in Table 6-1 dominant cation, CEC, sulphide, sulphur, organic carbon and content of accessory minerals are measured and documented in the production. The values of these parameters will depend on the selected bentonite product, at this stage the values given in Table 3-2 provides an estimation of the range at the initial state.

Based on the initial state values of the design parameters of the backfill and the deposition tunnel volumes discussed in Section 6.1.4 the installed dry density, mass and porosity have been calculated, the results are given in Table 6-2.

For the assessment of the long-term safety a set of physical variables have been selected to allow an adequate description of the long-term evolution of the backfill /SKB 2010/. The initial state for these variables is presented in Appendix B.

6.1.2 Material composition

Since the procedures applied by bentonite suppliers are similar for alternative bentonite products the procedures to qualify suppliers, order and inspect delivered bentonite material will be similar for buffer and backfill materials. To assess the conformity of the produced backfill to the reference design the experiences gained from various deliveries of bentonite materials can be utilised as a complement to the few available data from the example material, Milos backfill. The experiences indicate that a potential supplier can deliver bentonite with montmorillonite content according to the reference design (Section 5.2.6). To confirm that a bentonite according to specification can be delivered the supplier should be qualified according to approved routines.

The X-ray diffraction method SKB intends to apply to inspect the montmorillonite content of the delivered material has based on current experiences an accuracy of measurement described by a standard deviation of about 1.7% (Section 5.2.4). SKB's experience is that the described inspection method and application of conventional industrial procedures for qualification of suppliers will yield satisfactory mineral composition of the material used in the production of backfill components.

When ordering bentonite for the backfill specifications will be provided for the content of montmorillonite and the methods that shall be used by the supplier for self inspections. The inspection method applied by SKB will be further developed to enhance the accuracy. Taking this into account it is reasonable to assume that the variation in montmorillonite content will be less than the accepted, 45–90%.

6.1.3 Blocks and pellets

SKB's experiences from compaction of bentonite blocks from different bentonite products show that blocks with high enough precision of density and geometry can be produced provided that water content, grain size distribution and the pressing process is adapted to the selected material (see Section 5.3.7).

Inspections of weight and dimensions can be performed with conventional equipment with sufficient accuracy to identify blocks and pellet filling with too high or low density. The accuracy in measured density has been estimated to $\pm 0.5\text{--}1\%$ (see Section 5.3.6) which can be compared to the accepted variation in block density of $1,700 \pm 50 \text{ kg/m}^3$ corresponding to $\pm 3\%$ and pellet density of $1,000 \pm 100 \text{ kg/m}^3$ corresponding to $\pm 10\%$.

Table 6-2. Dry density, installed mass, volume of air at the initial state of the backfill.

Parameter	Initial state	
	Average value ¹	Range
Dry density (kg/m ³)	1,504	1,458–1,535
Dry mass per m tunnel (ton)	34.1	36.44–32.85
Porosity (m ³ /m ³)	0.46	0.44–0.48
Mass of water per m tunnel (tons)	5.80	5.56–6.20
Volume of air per m tunnel (m ³)	4.62	4.00–5.70

¹ Based on nominal backfill component densities and the assumed average tunnel volume.

In summary SKB conclude that the pressing of blocks and pellets must be adapted to the selected material to achieve a reliable process. A strategy for selection of blocks and pellets for inspection of the resulting density will be developed. The objective is to keep the probability to install blocks and pellets with unacceptable density very low. Blocks and pellets from every batch will be selected for inspection and measurements will be performed both in connection to the manufacturing and installation.

The available data from pressing of blocks from low-grade bentonites using equipment similar to that SKB intend to use show that the variation in the resulting block densities can be expected to be well within the acceptable range of $\pm 50 \text{ kg/m}^3$ (see Section 5.3.7).

6.1.4 Installed backfill density

The installed backfill density will depend on the installed backfill mass and the volume of the deposition tunnel. The installed backfill mass will in turn depend on the portions of the excavated deposition tunnel filled with blocks and pellets and the void volume. The design parameter of the backfill of most importance for the installed density is the block filled part of the tunnel volume, which in turn depends on the variation of the tunnel cross section. The larger part of the tunnel that can be filled with blocks the larger installed density. The void volume will reduce the density. Voids will occur between the blocks and in the pellet filling both due to the voids that exist in a loose filling and the fact that the whole space between the blocks and the walls of the tunnel may not be filled with pellets due to irregularities in the rock surface.

In the production the volumes and masses will be recorded, and the portions filled with bottom bed, blocks and pellets calculated, as described in Sections 5.4.3–5.4.8. However, at this stage of development results from these kind of measurements are not available and the installed backfill density has been estimated from the block and pellet densities and the excavated deposition tunnel geometries as presented in the **Underground construction report**, Section 5.2.2 and Appendix A. The installed density has been estimated for one blasting round, which will be representative for the deposition tunnel as a whole since the blasting rounds will follow each other along the tunnel. The installed densities have been calculated for three alternative volumes of the blasting rounds:

- an extremely small volume,
- an average volume and
- an extremely large volume.

The extremely small volume represents the highest possible installed density. The average volume represents the estimated average installed density. The largest volume represents the lowest possible installed density. The extremely small volume is set to the theoretical volume for the blasting round, see Figure 6-1, assuming a look-out angel of 250 mm which is recommended to avoid underbreak, see **Underground construction report**, Section 5.2.2. The average volume is based on the average excavated volume per blasting round in the TASS-tunnel (T = tunnel; AS = Aspo hard rock laboratory; S = tunnel id) which in the **Underground construction report** was assessed to exceed the nominal volume with 18%. The largest volume is set to the maximum accepted volume, i.e. 30% larger than the nominal.

Assuming that the length of a blasting round will be about 4 m, which was the average in the TASS-tunnel, it will accommodate approximately 330 blocks. If the densities, e.i. the masses and dimensions, are normally distributed and the blocks are randomly selected, this means that the achieved average density can be used when estimating the installed density. The resulting installed densities for the small average and large volume are calculated for the reference geometrical configuration of the backfill, see Figure 3-2. In this configuration the blocks occupy a volume of 16.8 m^3 per metre tunnel, the whole space between the blocks and the tunnel walls are filled with pellets and the bottom bed consists of compacted pellets. In the calculations a void volume between the blocks of $0.3 \text{ m}^3/\text{m}$ tunnel (2% of the block volume) is assumed and the same density, $\rho_{\text{dry}} = 1,000 \text{ kg/m}^3$, has been used for bottom bed and pellet filling. The resulting densities are given in Table 6-3.

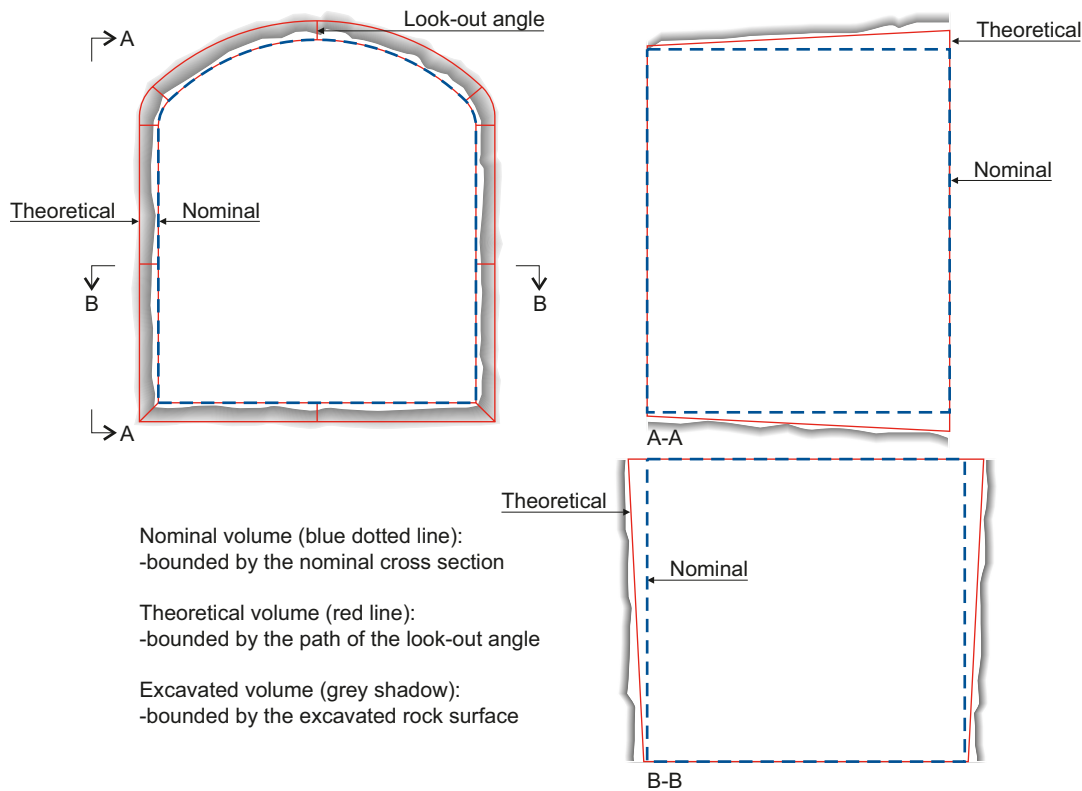

Figure 6-1. The volumes used when calculating the installed backfill density.

Table 6-3. Calculated tunnel volumes and installed dry densities per blasting round.

	Tunnel volume (m ³ /m tunnel)	Block part of volume (%)	Installed dry density (kg/m ³)
Lowest installed density	25	67.3	1,458
Average installed density	22.7	74.1	1,504
Highest installed density	21.4	78.7	1,535

The densities given in Table 6-3 can based on current experiences be regarded as a conservatively wide interval for the installed dry density in the deposition tunnel as a whole. However, locally both higher and lower densities can be expected. In the calculations the impact of varying void space between the blocks and lacking pellet filling in the space between the installed blocks and tunnel walls is not considered. However the impact on the installed density is limited, further the variation can be expected to be normally distributed along the tunnel and equalised if the tunnel as a hole is regarded. The deviation of the installed dry density from the average given in Table 6-3 as a result of increased void space between the blocks is illustrated in Figure 6-2, and the deviation in installed dry density resulting from lacking pellet filling is illustrated in Figure 6-3.

The installed dry density will also be affected by the density of the backfill in the upper part of the deposition hole. Seen over a tunnel length of 6 m, which is the nominal distance between deposition holes, the volume of the upper part of the deposition hole constitutes 4%. The nominal installed density in the deposition hole is 1,457 kg/m³. The slightly lower density in the upper part of the deposition hole will reduce the average density over a tunnel length of 6 m marginally, from 1,504 to 1,503 kg/m³.

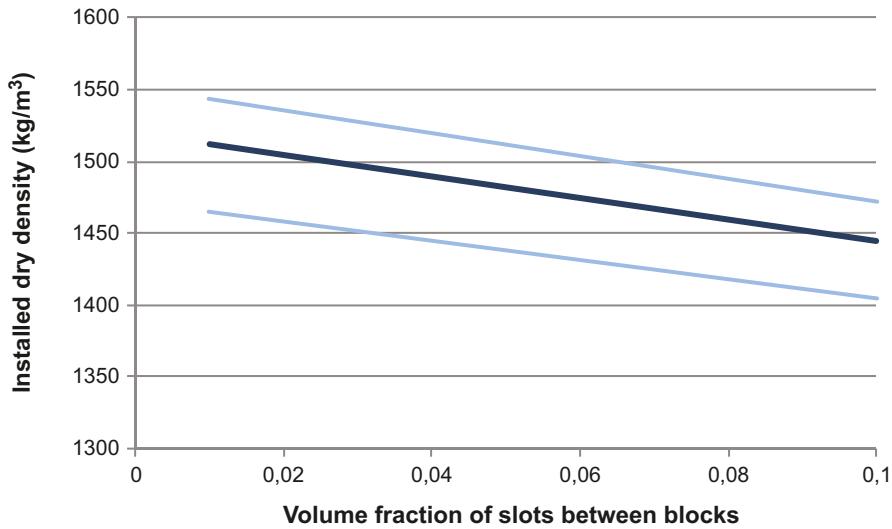

Figure 6-2. The installed dry density as a function of the volume fraction of the slots between the blocks in the block masonry. The installed dry density is calculated for the average tunnel volume (dark blue line) and the smallest and largest expected tunnel volumes (light blue lines).

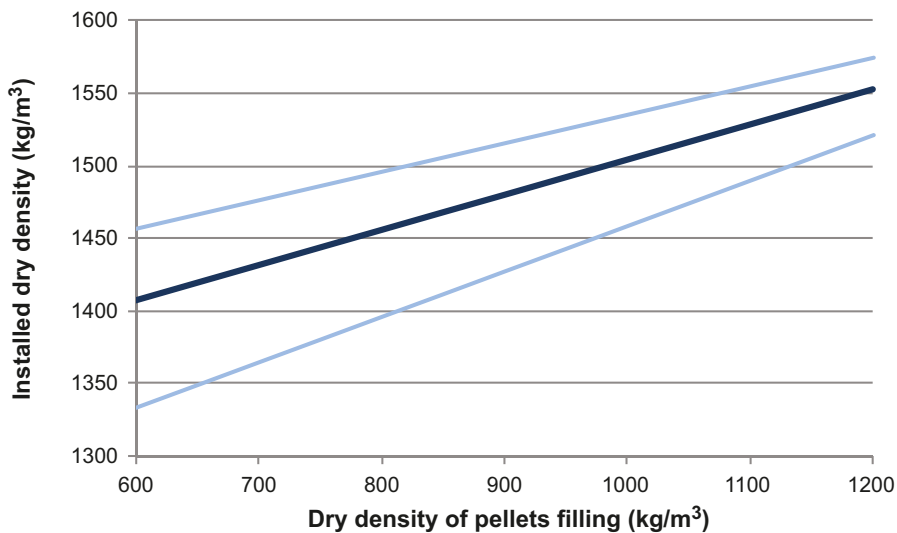

Figure 6-3. The installed dry density as a function of the density of the pellets filling. The installed dry density is calculated for the average tunnel volume (dark blue line) and the smallest and largest expected tunnel volumes (light blue lines).

In summary, considering the relatively large assumed variation in volume and the limited impact on the installed density of alterations in void space, the density interval given in Table 6-3 can be considered to cover the full spectra of variations in installed dry densities that can be expected for the initial state. The installed backfill density will thus, with ample margin exceed the dimensioning density of 1,240 kg/m³, which, as stated in Section 4.2, is required to avoid buffer swelling/expansion and keep the buffer density above 1,950 kg/m³.

6.2 Conformity to design premises long-term safety at the initial state

In this section the conformity of the backfill at the initial state to the design premises stated in **Design premises long-term safety** is summarised.

6.2.1 Hydraulic conductivity and swelling pressure

According to the design premises the hydraulic conductivity of the saturated backfill shall be less than 10^{-10} m/s and the swelling pressure shall be at least 0.1 MPa. In Section 4.1 it is concluded that an installed dry density of at least $1,120 \text{ kg/m}^3$ is required for Milos backfill to both reach the required hydraulic conductivity and the swelling pressure at groundwater salinities that may occur in the final repository. The limit is set by the hydraulic conductivity.

SKB's experience is that application of conventional industrial procedures for qualification of suppliers together with the applied inspection methods will yield a backfill bentonite with a montmorillonite that conforms to the reference design and it is reasonable to assume that the variation in montmorillonite content will be much less than the accepted.

The installed backfill density depends on the installed backfill mass and the volume of the deposition tunnel. The installed backfill mass will in turn depend on the portions of the excavated deposition tunnel filled with blocks and pellets and the void volume. The larger part of the tunnel that can be filled with blocks the larger installed density. In the production the volumes and masses will be recorded, and the portions filled with bottom bed, blocks and pellets calculated. However, at this stage of development results from these kinds of measurements are not available and presently the installed backfill density has been calculated from the block and pellet densities and the excavated deposition tunnel geometries as presented in the **Underground construction report**, Section 5.2.2 and Appendix A. The installed density is estimated for one blasting round, which is representative for the deposition tunnel as a whole since the blasting rounds will follow each other along the tunnel. The calculated installed dry density at the initial state is $1,458$ to $1,535 \text{ kg/m}^3$. Based on current experiences this dry density interval can be regarded as a conservatively wide interval for the deposition tunnel as a whole, locally both higher and lower density can be expected.

6.2.2 Compressibility restriction buffer swelling/expansion

The backfill material shall at the installed dry density and at saturation provide a sufficient counter pressure to restrict buffer swelling/expansion. The saturated buffer density shall be $1,950$ – $2,050 \text{ kg/m}^3$. The density and loss of buffer density by upwards swelling/expansion has been evaluated by calculations based mainly on the swelling properties of the buffer and the swelling pressure and the compressibility of the backfill. An installed dry density of Milos backfill of at least $1,240 \text{ kg/m}^3$ is sufficient to maintain the saturated buffer density above the canister above $1,950 \text{ kg/m}^3$. The installed dry density for the reference design is at least $1,458 \text{ kg/m}^3$, see Section 6.1.1.

6.2.3 Substances that may cause harmful buffer degradation or canister corrosion

The backfill material must not contain substances that may cause harmful buffer degradation or canister corrosion. Currently neither substances nor limits are given as design premises from the assessment of the long-term safety. Consequently the conformity of the backfill reference design to this design premise will be verified in the long-term safety assessment.

6.2.4 Maintain barrier functions

The backfill shall maintain its barrier functions and be long-term durable in the environment expected in the repository. For any backfill material the capability to maintain the barrier functions will depend on the installed density. In the final repository facility during installation some backfill material may be lost. Material may also be lost in the future during the assessment period both during and after saturation of the backfill. Neither of these material losses has yet been fully quantified. The margin between the average installed dry density (about $1,500 \text{ kg/m}^3$) and the dry density required to restrict buffer swelling/expansion ($1,240 \text{ kg/m}^3$) is 20% or 260 kg/m^3 .

7 Reference design of the plug

In this section the reference design of the plug is presented. In Section 7.1 the conceptual design and different parts of the reference plug and their functions are explained. In the Section 7.2 the main components of the installed plug and the design parameters that shall be inspected in the production are presented.

The reference design is a development of the plugs constructed for SKB's full-scale tests of backfill and plug. The full scale-test are "The backfill and plug test" /Gunnarsson et al. 2001/ and the "Prototype repository, Section II" /Dahlström 2009/. For the prototype repository two concrete plugs were constructed. To improve the water-tightness the concrete plug has in the reference design been complemented with a watertight seal and a filter collecting water leaking from the backfilled deposition tunnel during the curing phase. This conceptual solution is currently being evaluated, and it is the analysed design that constitutes the reference design at this stage of development. The detailed, as well as, the principal solution will be further developed before the construction of the final repository and deposition of encapsulated spent fuel commences. The development of the plug and backfill are integrated and will be adapted to the conditions at repository depth.

7.1 The parts of the plug and their functions

The plug in deposition tunnels consists of several parts that in different ways will contribute to maintaining its functions during the different phases (see Section 2.5) of its lifetime. The parts of the reference plug are illustrated in Figure 7-1.

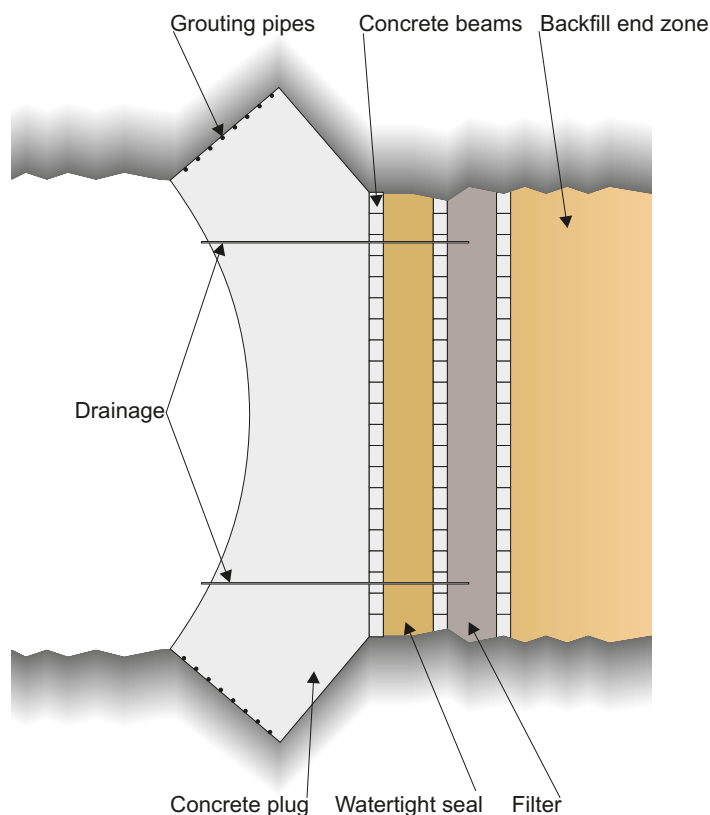

Figure 7-1. Schematic section of the reference design of the plug.

The parts of the reference plug and their general design and functions are:

- **Concrete plug:**
The concrete plug consist of reinforced concrete and contain pipes for auxiliary equipment such as: air ventilation tube, cooling and heating tubes, airbleed tube, concrete placement tubes and instrumentations. The concrete plug shall resist deformation and keep the watertight seal, filter and backfill in place.
- **Watertight seal**
The watertight seal is made of bentonite blocks and pellets in a similar configuration as the backfill. It shall seal preferred leakage paths through small cracks in the concrete plug or between the concrete and the rock surface. It shall take up the water pressure gradient over the plug so that no unfavourable water pressure is applied in the interface between the rock and the concrete and so that the water pressure within the backfilled deposition tunnel is equalised.
- **Filter**
The filter is made of sand or gravel. It shall collect water leaking from the backfill and if required drain it to the drainage pipes, so that no water pressure is applied on the concrete plug before it has cured and gained full strength.
- **Concrete beams**
The beams are made of reinforced concrete. The outer beams (towards the concrete plug) are covered with a thin layer of shotcrete to prevent mixture of concrete and the bentonite during casting the concrete plug. The concrete beams shall facilitate the construction works. The inner beams (towards the deposition tunnel) shall keep the backfill in place during the installation. The middle beams shall keep the filter in place and are designed to withstand the development of the pressure during compaction of the filter material. The outer beams (towards the concrete plug and main tunnel) shall keep the bentonite blocks in the watertight seal in place.
- **Drainage pipes**
The drainage pipes, need to be resistant throughout the sealing phase and are made of steel or if necessary titanium. They shall drain the water collected in the filter and transport it out from the deposition tunnel to prevent water pressure to be applied on the concrete plug before it has cured and gained full strength.
- **Grouting pipes**
The grouting pipes are made of steel and may be isolated by geotextile to prevent blocking during pouring. They shall be grouted when the concrete has reached a certain level of strength. The grout shall tighten the contact area between the concrete plug and rock and contribute to keeping the concrete plug prestressed.

In the backfill closest to the plug, referred to as the backfill end zone, it is possible to adapt the installed density to control the load on the plug. This adaptation is based on the reference design of the backfill and is made as a part of the design of the plug.

7.2 The installed plug and its material and components

In this section the installed plug and the materials and main dimensions of the different components used to construct the reference plug are presented. The main components of the installed plug and the design parameters that shall be inspected in the production are presented in Table 7-1 and the dimensions are shown in Figure 7-2. At this stage of development the presented data shall be regarded as examples and for some parameters it is not possible or meaningful to provide data at this stage of development.

The plug shall seal the deposition tunnel and limit the flow, or seepage, of water out from the deposition tunnel as long as the main tunnel is open and there is a pressure gradient over the plug. During the sealing phase the plug shall also keep the backfill in place and prevent it from swelling and expanding out from the deposition tunnel.

Table 7-1. The main components and design parameters of the installed plug.

Component / Design parameter	Nominal design	Accepted variations
Concrete plug		
Concrete	Low pH concrete-mix B200 (200 kg binder/m ³) according to recipe in Table 7-2	Will be determined according to standards for conventional concrete
Reinforcement	Quality K500ST ¹ Amount and geometry according to reinforcement drawing ¹	According to standard According to reinforcement drawing ¹
Dimensions	According to drawing ² (see Figure 7-2)	According to drawing ²
Watertight seal		
Thickness	0.71 m	±10 mm
Material composition	See Table 3-1	See Table 3-1
Installed dry density	1,500 kg/m ³	To be determined
Filter		
Installed dry density	> 1,900 kg/m ³	To be determined
Thickness	0.7 m	Tolerance of 5%
Beams³ and other prefabricated components		
Concrete in beams	Low pH concrete-mix	Will be determined according to standards for conventional concrete
Reinforcement in beams	Standard steel quality	According to standard
Drainage pipe material	Titanium	According to standard
Drainage pipe dimensions	To be determined	To be determined

¹ The reinforcement may be omitted or the amounts determined according to conventional design principles.

² Detailed drawings will be made according to conventional procedures.

³ Will be designed according to conventional procedures.

Table 7-2. Reference concrete recipe for the concrete in the plug.

Design parameter	Nominal design (kg/m ³ if not specified)
Binder	
Cement CEM I 42.5 MH/LA/SR	120
Silica fume (densified)	80
Other components	
Water	165
Limestone filler L25	369
Sand 0–8 mm	1,037
Gravel 8–16 mm	558
Glenium 51	6.38
water/cement	1.375 (kg/kg)
water/binder	0.825 (kg/kg)
water/powder	0.29 (kg/kg)

7.2.1 Concrete plug

The concrete and reinforcement of the plug is determined so that it will have the strength and tightness required to conform to the design premises in Table 2-5. The reinforcement in the concrete beams shown in Figure 7-1 may be omitted. The two main components affecting the properties of the concrete are the amount of binder and the composition of the binder. Low pH concrete must be used to avoid negative impact on the barriers of the final repository. A low pH concrete (less than 11) is a concrete where 40 wt-% of the binder is replaced with silica fume.

The binder is also of importance for the thermal, viscoelastic and shrinkage properties that impact the potential for cracking due to the heat development during hydration and subsequent cooling and shrinking of the concrete. The binder shall conform to the design premises stated in Table 2-6. Further, components that may impact the barriers of the final repository must be avoided in the concrete, see Table 2-4.

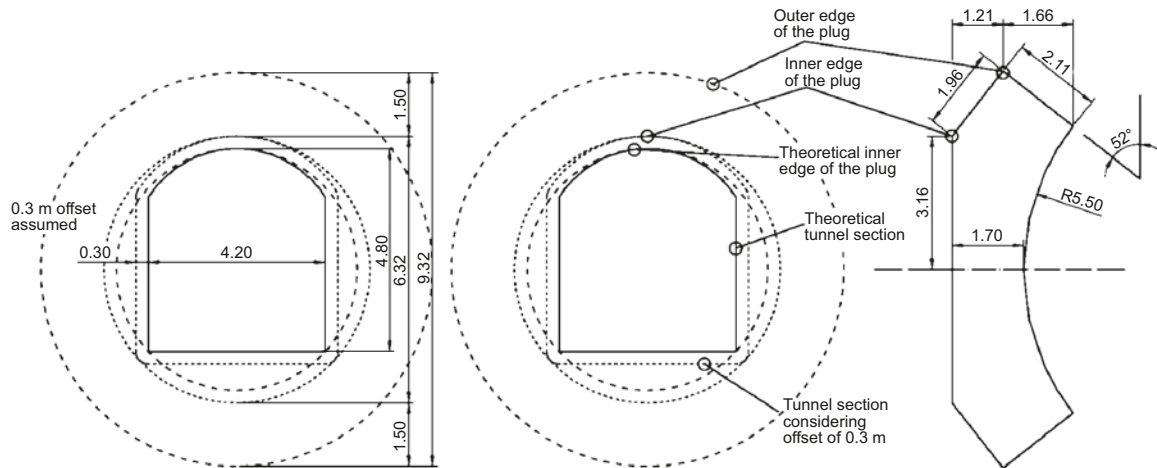

Figure 7-2. Dimensions of the concrete plug.

To achieve a reliable construction process the reference concrete is a self compacting concrete (SCC). Omitting vibration also results in more favourable working conditions.

7.2.2 Watertight seal

The volume of water passing the watertight seal during the sealing phase shall be limited, and the required water tightness will determine the material composition and installed density. The seal is designed to have a low hydraulic conductivity, it must swell and seal all passages and it must be able to withstand a high hydraulic gradient. The water tight seal is artificially saturated through the drainage pipes. A very low gradient over the seal is applied to ensure that no piping channels are created.

To achieve a reliable and cost-effective production the intention is to use the same equipment for manufacturing of blocks and pellets as for the backfill. In the reference design the same material and block dimensions as for the backfill are used.

7.2.3 Filter

The filter is designed to collect the water that may have to be led passed the concrete plug through the drainage pipes during the curing phase. It may also be used to apply a water pressure inside the plug and thereby prevent erosion of bentonite through the plug if it turns out that the plug is not sufficiently watertight. These design premises determine the filter material, its grain size distribution and the compaction of the material.

7.2.4 Prefabricated components

The concrete beams will be designed according to relevant standards for concrete constructions. For the low pH concrete there are currently no available standards regarding the strength and other properties. Standards similar to those of conventional concrete will be developed. At this stage of development it is not relevant to specify the details of the prefabricated components.

8 Conformity of the reference plug to the design premises

The objective of this chapter is to verify the conformity of the reference plug presented in Section 7.2 to the design premises presented in Section 2.5. In Section 2.5 the design premises for the plug are divided into design premises:

- related to the production,
- from the engineered barriers,
- related to the properties in the KBS-3 repository.

Further the lifetime of the plug is divided into three phases, the curing, sealing and post closure phases, during which the conformity of the reference plug to the design premises shall be verified. The design premises related to the production shall be verified for the curing phase. The design premises from the engineered barriers shall be verified for the sealing phase and the design premises related to the properties in the KBS-3 repository shall be verified for the post closure phase. In summary the following shall be verified for the different phases:

- the curing phase:
 - internal cracking in the young concrete that can hazard the function of the plug will not occur.
- the sealing phase:
 - the strength of the concrete plug is sufficient to withstand the loads occurring in the final repository facility until it is closed,
 - the water tightness of the plug is sufficient to prevent leakage out from the deposition tunnel until the adjacent main tunnel is closed and saturated,
 - the durability of the plug is sufficient to withstand the conditions occurring in the final repository facility during its operational phases.
- the post closure phase:
 - long-term volume decrease will not result in significant reduction of the backfill density,
 - the plug does not contain materials that may hazard the functions of the barriers of the KBS-3 repository.

In the following sections verifying analyses for each phase of the lifetime of the plug are presented. At this stage the verifying analyses consist of calculations and laboratory tests. To verify the interaction between the backfill, seal, filter and concrete plug a full-scale test is planned.

The plugs constructed for the Prototype repository, Section II were designed with respect to the expected pressures and loads /Dahlström 2009/. In the development performed for the presented reference design the conventional concrete is replaced with low pH concrete and the loads the plug is exposed to have been developed /Dahlström et al. 2009/.

8.1 The curing phase

8.1.1 Concrete plug

The curing phase comprises the time from the pouring of the concrete to the time it has gained its full strength. For the curing phase it shall be verified that the thermal, viscoelastic and shrinkage properties of the concrete will not result in internal cracking in the young concrete that can hazard the function of the plug. During the curing phase cracks in the concrete can form as a result of the heat development due to hydration. /Vogt et al. 2009/ analysed the risk for early cracking in young low pH concrete. The effects of actions as cooling the concrete has been evaluated within the Prototype repository project /Dahlström 2009/. /Vogt et al. 2009/ concluded that it is possible to mix a low pH concrete with the required properties and that the curing and the development of the strength can take place without the formation of cracks.

8.1.2 Filter

The filter material, its grain size distribution and compaction shall be such that the filter can collect and drain water so that the concrete plug is not exposed to high water pressures until it has gained sufficient strength. It is designed and verified in accordance with conventional geotechnical procedures.

8.2 The sealing phase

The design premises for the sealing phase are set by the buffer and backfill and are presented in Table 2-5.

8.2.1 Concrete plug

During the sealing phase the concrete plug shall resist the hydrostatic pressure at repository depth and the swelling pressure from the backfill and watertight seal. The concrete shall be watertight and the plug designed to be durable for up to 100 years.

The resistance of the low pH concrete against water penetration was evaluated by /Vogt et al. 2009/. The evaluation was made according to standard procedures (Standard SS-EN 12390-8 for water tight concrete) and it was concluded that the concrete is watertight.

Design calculations for the plugs in the Prototype repository was performed by /Dahlström 2009/. Renewed analyses have been performed for the presented reference design /Dahlström et al. 2009/. Besides the change to low pH concrete the most essential changes compared to the analyses performed for the Prototype repository are:

- the plug is designed for increased loads from water pressure and swelling pressure from the backfill,
- it is analysed if it is possible to reach the desired strength without using any reinforcement.

The reason to omit the reinforcement is that low pH concrete shrinks more during curing than conventional concrete. In connection to the reinforcement the shrinkage may result in cracks which potentially could transport water through the hardened concrete. Further, the reinforcement is time consuming to install and omitting it would save time and cost.

From the performed analysis it is concluded that it is possible to use low pH concrete and reach the desired strength. It is also concluded that sufficient strength can be obtained without using reinforcement, however, this will be scrutinised and in the reference design the plug is still reinforced.

8.2.2 Watertight seal

It shall be verified that the material composition and density of the watertight seal will result in a water tightness of the installed seal sufficient to limit the amount of water passing the plug, see Table 2-5. Water shall be prevented from passing the plug for occurring flow gradients over the plug. The accepted water volume to pass the plug will depend on the acceptable transport of clay material out from the deposition tunnel during the sealing phase, and remains to be determined. For the water tight seal to work as intended it has to be saturated under a low pressure gradient as described in Section 7.2.2. The specific procedure for this remains to be developed. The installed dry density of the watertight seal will for the reference design of blocks and pellets be about 1,500 kg/m³. According to Figure 4-1 the hydraulic conductivity of the reference material at this density will not exceed 10⁻¹¹ m/s.

8.3 The post closure phase

For the post closure phase it shall be verified that the reference plug conform to the design premises related to its properties in the final repository presented in Table 2-4. The plug must not contain materials that could be harmful for the engineered barriers. Further the plug material shall remain in its place in the final repository and not decrease in volume so as the backfill can expand and lose so much density that its barrier functions are not maintained.

To conform to the design premise not to use materials that may be harmful for the engineered barriers low pH concrete is used and organic material avoided. At this stage no limits for acceptable amounts are set and the used materials and amounts are merely listed. To investigate the decrease in volume the materials in the plug has been divided into *stable* and *transformable*. Stable refers in this context to materials considered to be immovable and that will remain in the final repository. Transformable refers to materials and substances that may be dissolved or transformed when exposed to the groundwater in the final repository. The different substances in the plug, their total amounts and the amounts regarded as stable and unstable are given in Table 8-1. The watertight seal consists in the reference design of bentonite material and is omitted from Table 8-1.

The total volume of the concrete plug is approximately 100 m³. Dissolving or transforming a substance will result in that the volume it originally occupied will be filled with some other substance and the porosity and density altered, e.g. concrete to concrete degradation products and iron to iron corrosion products. The volume will be the same unless the material is compressed or transported away. The maximum mass that can be dissolved or transformed is 98 tonnes per plug, this sets an upper limit for the amount of material that potentially can be replaced by backfill material.

Table 8-1. Components and substances in the plug and the amounts which based on expert judgements are regarded as stable and transformable. The amounts have been estimated for one plug.

Part of the plug	Substance	Stable (tonnes)	Transformable (tonnes)
Concrete plug	Cement 42.5 MH/LA/SR		12
	Silica fume (densified)		8
	Water		17
	Limestone filler L25		37
	Sand 0–8 mm	104	
	Gravel 8–16	56	
	Glenium 51		0,6
Concrete beams	Cement 42.5 MH/LA/SR		2.7
	Silica fume (densified)		1.8
	Water		3.7
	Limestone filler L25		8.3
	Sand 0–8 mm	23.3	
	Gravel 8–16 mm	12.6	
	Glenium 51		0.1
Filter	Reinforcement		6.8
	Gravel 8–16 mm	25.3	
Total:		221.2	98

9 Production of the plug

9.1 Overview

9.1.1 Design premises for the production of the plug

In this section the design premises for the development of methods for production, test and inspection of the plug are given. *The design premises are written in italics.*

The plug components and the installed plug shall conform to the reference design as specified in Section 7.2. In addition the considerations presented in Section 2.2.3 shall be kept in mind when developing the methods (systems and processes) for preparation, installation, tests and inspections of the plug. The methods for production of the plug must also be applicable for the current installation procedure of the backfill described in Sections 5.4.3–5.4.8. The resulting design premises for the development of methods for construction, test and inspection of the plug are compiled in Table 9-1.

Avoiding malfunction of the plug causing retrieval of installed backfill (frequency of 10^{-3} or less in Table 9-1) is also a consequence of SKB's objective to minimise the potential radiation doses during the operation of the KBS-3 repository facility.

Table 9-1. Design premises for the production and methods for preparation, installation and inspection.

Required function, property or design consideration	Required capability of method/ production	Design premise
<i>The plug must not significantly impair the barrier functions of the engineered barriers or rock. Installation of the plug shall be possible to perform in the prescribed rate.</i>	<i>To limit the transport of clay material out from the deposition tunnel the time until the plug has been installed and gained its full strength and water tightness shall be as short as possibly achievable.</i>	<i>Allowed inflow to deposition holes and deposition tunnel. Volume of water accepted to be transported out from the deposition tunnel.</i>
<i>The plug must not significantly impair the barrier functions of the engineered barriers or rock.</i>	<i>Material composition and amounts shall be recorded.</i>	–
<i>The plug and methods for preparation, installation, test and inspection shall be based on well-tried or tested technique.</i>	<i>The methods for construction and inspection of the plug shall as far as possible be based on experiences and established practice from similar applications.</i>	–
	<i>If there is a lack of experiences the reliability of the methods shall be tested and demonstrated.</i>	–
<i>Plugs with specified properties shall be possible to prepare and install with high reliability. The plug and methods to install, control and verify the plug shall be cost-effective.</i>	<i>The curing of the concrete plug shall take place without the formation of cracks.</i>	–
	<i>The full pressure against the concrete plug must not appear until it has cured and gained sufficient strength.</i>	–
	<i>The construction shall result in a plug with acceptable properties and be repeatable and reliable.</i>	–
	<i>The frequency of the event: "Malfunction of the plug causing retrieval of installed backfill." shall be low.</i>	<i>Frequency 10^{-3} or less per installed plug in deposition tunnels.</i>

9.1.2 The production of the plug

The production of the plug comprises the following three main parts, see Figure 9-1:

- ordering, delivery and storage,
- manufacturing, preparation and storage of components,
- installation of all parts except concrete plug,
- installation of the concrete plug.

The production of the plug is illustrated in Figure 9-1, from the material delivery to the installation in the deposition tunnel. The figure also includes a flow chart for the production.

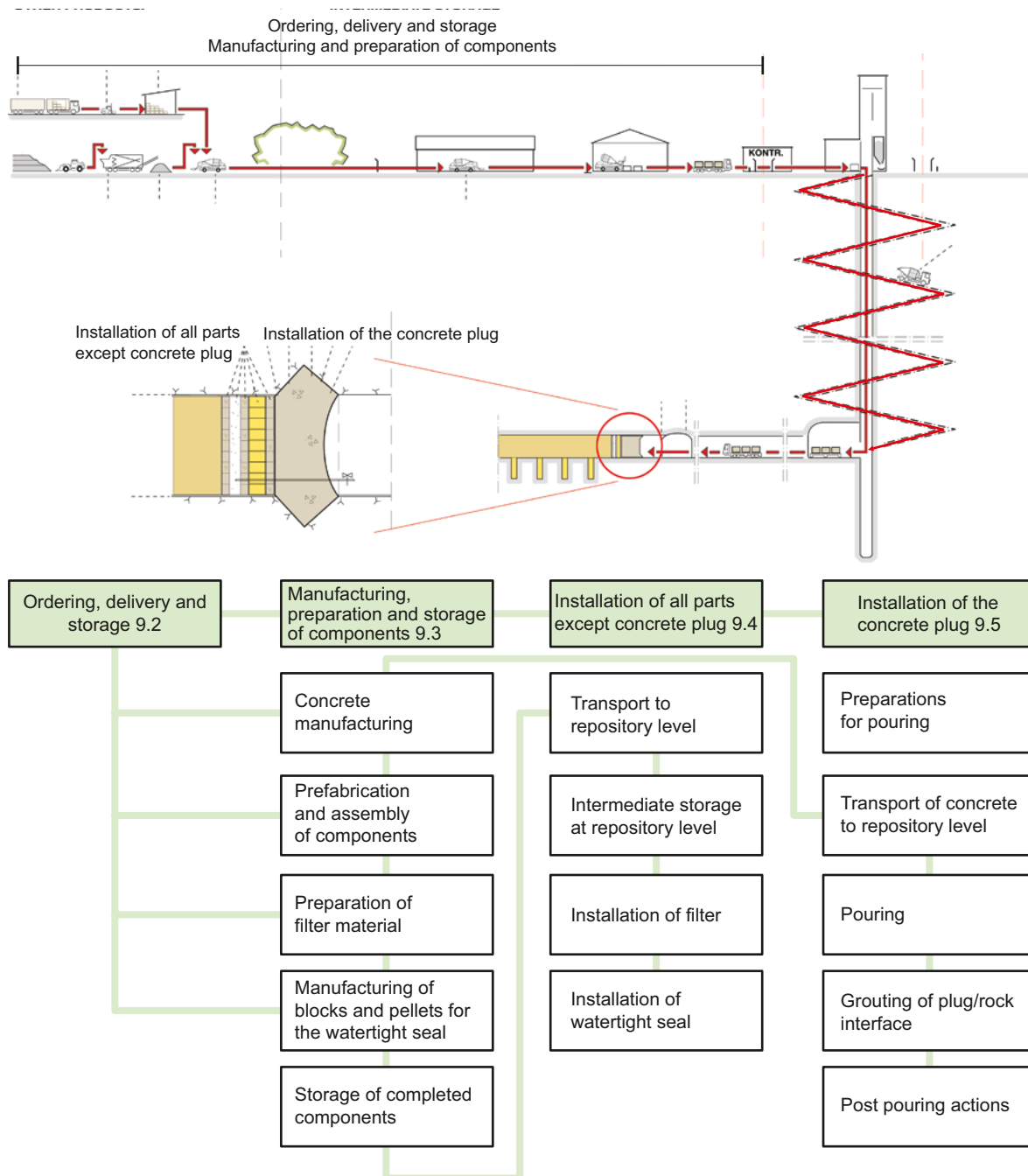

Figure 9-1. Upper panel: Illustration of the production of the plug from the delivery of the material to the installation in the deposition tunnel. Lower panel: The main parts of the production (green) and sections in the text where they are described, and a flow chart for all stages in the production.

9.1.3 Reference methods for construction and inspections

With respect to the requirements on the production the reference methods for construction of the plug is based on established technique from similar applications. All stages in the production of the plug will follow generally applied procedures. For the manufacturing of components for the watertight seal and installation of the seal the same methods as for the backfill are applied (see Section 5.1.3). For the preparation and installation of the filter, manufacturing and installation of beams and pipes as well as installation of the concrete plug, SKB intends to apply conventional and generally applied methods both for the involved processes and inspections. For the concrete works SKB need to customise the procedures to the low pH concrete.

With respect to the properties of the buffer and backfill it is important that the plug is installed and gain its full strength and water tightness as soon as possible after the completion of the backfill. Special attention will be taken to ensure that material and components according to specifications are provided in time for each stage in the production.

9.1.4 Key stages in the production of the plug

For the engineered barriers the expected values of the design parameters at the initial state is required for the assessment of the long-term safety, and the processing and inspections of the design parameters throughout the production are illustrated in process-inspection schemes, e.g. see Figure 5-2. Regarding the plug the long-term safety assessment is based on the assumption that there is a watertight plug in the end of the deposition tunnel and that this plug will be left and remain in the repository after closure. Both with respect to this and that the installation of the plug is a conventional construction procedure, a simplified production scheme is presented for the production of the plug. The scheme is shown in Figure 9-2, for each main part of the production the stages of most importance for the resulting tightness and strength of the finished plug, and the activities ensuring that no unwanted substances are left in the repository are presented. For each main part of the production an overview of the activities focusing on how the requirements on the production are fulfilled is given.

Part of the plug	Ordering, delivery and storage	Manufacturing, preparation and storage of components	Installation of all parts except concrete plug	Curing phase
				Installation of the concrete plug
Concrete plug	Specification and delivery of material	Mixing of ingredients	–	Preparations for pouring
	Storage time and environment			Pouring
				Control of temperature
				Inspection of pressure
Watertight seal	Specification and delivery of material	Pressing of blocks	Installation	
Filter	Specification and delivery of material	–	Installation (compaction)	
Concrete beams	Specification and delivery of material			
Drainage pipes	Specification and delivery	–	Installation	
Grouting pipes	Specification and delivery of material	–	–	Grouting

Figure 9-2. The key activities ensuring that a watertight plug with properties acceptable in a long-term perspective is installed.

9.2 Ordering, delivery and storage

9.2.1 Overview of processes and inspections

The following categories of materials and components are required for the plug:

- concrete or concrete ingredients,
- filter material,
- clay for the watertight seal,
- prefabricated components (e.g. reinforcement cages, concrete beams and pipe arrangements for cooling),
- auxiliary equipment and materials (e.g. geotextile, heating devices, instrumentation).

Prefabricated components and concrete can be manufactured within the industrial area of the final repository facility or be bought from external suppliers. The filter material can either be bought or prepared at the site from the excavated rock from the sub-surface facility.

The materials and products for the plug will be purchased according to specifications based on the detailed design documents, drawings and specifications. Each material or product shall be specified in a standardised protocol that shall follow the material or product through the production. At the delivery the protocols and the delivered products are inspected and the function of instrumentation is tested.

In order to avoid delays and interruptions in the installation of the plug it is important to keep suitable stocks of material and equipments. The stores shall provide suitable protection and environment for the materials.

Established procedures, protocols and inspections based on experiences from similar construction work and branch practice are available for the ordering and delivery.

9.2.2 Issues of importance for the resulting properties of the plug

The material compositions of the ordered materials are determined by activities performed by the supplier and cannot be processed in later stages. It is thus important that the suppliers are qualified and that the delivered material is inspected at delivery. It is also important that it is clearly stated in the order whether any substances must be avoided and which substances that shall be specified by the supplier.

9.3 Manufacturing and preparation of components

9.3.1 Overview of processes and inspections

Plug components to be manufactured or assembled comprise concrete beams, beam supports, reinforcement cages, pipe arrangements and formwork. Further blocks and pellets for the watertight seal shall be manufactured and material for the filter prepared.

According to the current plans the concrete beams will be prefabricated. Formwork, beam supports and reinforcement cages will be constructed, and pipe arrangements assembled, prior to transportation to repository depth. Instrumentation and equipment for monitoring can be assembled with the reinforcement or formwork.

Blocks and pellets with the same dimensions as for the backfill will be used for the watertight seal. They will be manufactured and inspected as described in Section 5.3.

The material for the filter will be mixed to the required grain size distribution and transported to repository level.

The dry ingredients of the concrete will be mixed at ground level before transportation to repository level.

The manufacturing, preparation and inspection of the components for the plug, and the preparation and inspection of the concrete and filter material will follow conventional procedures.

9.3.2 Issues of importance for the resulting properties of the plug

To avoid interruptions in the installation of the plug sets of components should be completed in advance and stored at site. The storage shall be arranged to minimise the risk of damages.

Performed tests on low pH concrete confirm the importance of correct determination of aggregate moisture and correct mixing order of the ingredients for the properties of the concrete. Satisfactory mixing can be performed with standard equipments /Vogt et al. 2009/.

9.4 Installation of all parts except concrete plug

9.4.1 Overview of processes and inspections

The concrete beams, drainage pipes, filter and watertight seal are installed in the order presented below.

1. The first wall of concrete beams is installed in parallel to the backfill in the backfill end zone.
2. The filter, second wall of concrete beams and the first sections of the drainage pipes are installed. To facilitate the compaction of the filter material the beams and filter are installed in parallel.
3. The watertight seal, third wall of concrete beams and the second section of drainage pipes are installed. The bentonite blocks for the watertight seal are emplaced tight to the second wall of concrete beams in a similar pattern as the backfill blocks in the deposition tunnel. The third wall of concrete beams is installed tight to the bentonite blocks and the empty space between the bentonite blocks and the rock wall is filled with pellets.
4. A layer of shotcrete is applied to the third wall of concrete beams. The wall can then act as formwork for casting of the concrete plug and seal gaps between the concrete beams in the wall so that concrete and bentonite are not mixed.

The installation and inspection of materials and components will follow conventional procedures.

9.4.2 Issues of importance for the resulting properties of the plug

The filter material will be compacted during the installation to minimise potential deformation of the filter from the swelling of the backfill. The content of water in the filter material will be inspected to ensure that the specified grade of compaction can be achieved during installation.

The rock surface will be scanned to determine the volume of the deposition tunnel where the watertight seal is installed. The weight of blocks and pellets installed is recorded and from the known water content the dry density of the watertight seal can be calculated. The dry density shall be sufficient to ensure that the seal has the specified hydraulic conductivity required during the sealing phase.

9.5 Installation of the concrete plug

9.5.1 Overview of processes and inspections

The installation of the concrete plug requires that a recess is prepared in the rock, see the **Underground openings construction report**, Section 5.2.5.

The concrete plug is installed in the order presented below.

1. The rock surface is cleaned and the assembled reinforcement cages are installed. The cages are anchored in the rock with bolts. Cooling pipes and instrumentation for monitoring of mechanical response and temperature are also installed in this stage.

2. The formwork, tubes for concrete placement, an air-bleed tube, instrumentation, the third section of drainage pipes and grouting pipes are installed. The formwork consists of a framework of steel beams that carries up the mould made of wood, plywood and Plexiglas. Pipes for injection/pouring are installed at two levels and at the highest point in the formwork an air-bleed tube is installed to permit air escape from the form during pouring. Grouting pipes for grouting of the area between the concrete plug and rock surface are installed.
3. The equipment is tested and the concrete is mixed and poured. All equipment is tested to ensure their correct functioning. The dry ingredients for the concrete are mixed at surface level and after adding water and plasticisers the final mixing of the concrete is made at repository level. To eliminate possibility of a cold joint the plugs will be constructed as a continuous pour. Once concrete is observed exiting from the air-bleed tube, concrete will have filled the formwork and the tube valve will be closed.
4. The plug cures and if required to reduce the pressure against the plug water is drained through the drainage pipes. If necessary to avoid internal cracking due to cement hydration the plug is cooled with circulation of cooling water in pipes during the curing. The cooling of the concrete shall continue until the peak heat of hydration has passed.
5. The interface between the concrete plug and rock surface is grouted. During curing the concrete shrinks and to seal the interface between the concrete plug and rock surface grouting is performed after curing. The cured plug is cooled to a temperature about 10°C below the surrounding temperature. The grouting is performed. The cooling of the plug continues until the end of the maturing period of the grout and is then stopped. The concrete plug will then expand and pre-stress the plug.

The installation and inspection of the concrete plug will follow conventional procedures.

9.5.2 Issues of importance for the resulting properties of the plug

All equipment shall be tested to ensure that they are functioning correctly before start of the pouring. Failure of equipment during pouring creates the risk that the plug cannot be installed, and installed portions of the concrete plug section must be removed and re-installed. To make the period until there is a watertight seal in the end of the deposition tunnel as short as possible it is also important that there are no delays in the installation of the concrete plug.

To avoid internal cracking due to cement hydration it is important to continuously record the temperature and if necessary cool the plug.

To prevent leakage through the plug and/or the interface between the plug and the rock surface the plug must be in contact with the rock over its full length. Further, cracks in the plug must not act as hydraulic paths. Therefore it is important that the interface between the plug and the rock is grouted and the plug pre-stressed.

Inspections to ensure that the plug is functioning as intended shall be performed e.g. in case of observed leakage the leakage past the plug will be measured.

10 Initial state of the plug

The presentation of the initial state of the plug and its conformity to the reference design is divided into two sections:

- initial state,
- functions during the sealing phase.

The plug has no barrier functions in the final repository. In the final repository the plugs can be regarded as residual materials left in the repository when it is backfilled and closed. For the initial state the conformity of the material composition and compressibility of the installed plugs to the reference design shall be verified.

The functions of the plug during the sealing phase may impact the properties of the buffer and backfill. For the sealing phase it shall be verified that the watertightness, strength and durability of the installed plugs are sufficient to avoid loss of buffer and backfill material that result in significant negative impact on the buffer and backfill barrier functions.

10.1 Initial state of the plug and its conformity to the reference design

The plug properties to be designed to conform to the design premises related to the properties in the KBS-3 repository are:

- material composition,
- volume and compressibility.

The plug will be designed and constructed according to conventional procedures. At this stage of development it is assumed that the material composition and volume of the plug at the initial state will be as specified for the reference design, illustrated in Figure 7-1. This assumption is based on experiences from the prototype repository, which shows that plugs according to specification can be constructed by applying conventional procedures.

The components of the plug and their substances and masses are given in Table 10-1 which also contains information on which substances that are considered to be stable or transformable. Stable refers in this context to materials considered to be immovable and that will remain in the final repository. Transformable refers to materials and substances that may be dissolved or transformed when exposed to the groundwater in the final repository. The recipe of the concrete is given in Table 10-2. The total volume of the concrete plug will be about 100 m³.

Table 10-1. Components and substances in the plug and the amounts which based on expert judgements are regarded as stable and transformable. The amounts have been estimated for one plug.

Part of the plug	Substance	Stable (tonnes)	Transformable (tonnes)
Concrete plug	Cement 42.5 MH/LA/SR		12
	Silica fume (densified)		8
	Water		17
	Limestone filler L25		37
	Sand 0–8 mm	104	
	Gravel 8–16	56	
	Glenium 51		0,6
Concrete beams	Cement 42.5 MH/LA/SR		2.7
	Silica fume (densified)		1.8
	Water		3.7
	Limestone filler L25		8.3
	Sand 0–8 mm	23.3	
	Gravel 8–16 mm	12.6	
	Glenium 51		0.1
Reinforcement		6.8	
Filter	Gravel 8–16 mm	25.3	
Total:		221.2	98

Table 10-2. Reference concrete recipe for the concrete in the plug /Vogt et al. 2009/.

Design parameter	Nominal design [kg/m ³ if not specified]
Binder	
Cement CEM I 42.5 MH/LA/SR	120
Silica fume (densified)	80
Other components	
Water	165
Limestone filler L25	369
Sand 0–8 mm	1,037
Gravel 8–16 mm	558
Glenium 51	6,38
water/cement	1.375 kg/kg
water/binder	0.825 kg/kg
water/powder	0.29 kg/kg

10.2 Functions of the plug during the sealing phase

The plug properties, and related design parameters, to be designed for the plug to conform to the design premises related to its functions during the sealing phase are:

- Strength of the concrete plug:
 - concrete recipe – amount of binder,
 - reinforcement – quality and amount,
 - maximum applied swelling pressure:
 - length and installed dry density in the backfill end zone.
- Watertightness:
 - watertight seal:
 - material composition: montmorillonite content,
 - installed density: density and dimensions of components (blocks and pellets), geometry of the installed components,
 - concrete plug:
 - properties of the interface rock/grouting/concrete.
- Deformation properties and bond between concrete plug and the rock:
 - concrete recipe – amount of binder,
 - reinforcement – quality and amount,
 - bond between concrete plug and the rock.
- Concrete plug durability:
 - concrete recipe,
 - reinforcement: quality
 - drainage pipes durability: material corrosion class.

Experiences from the prototype repository indicate that the concrete plug needs to be complemented with a watertight seal to reduce the amount of water passing the plug. The accepted volume of water passing the plugs remains to be determined. For the reference design the hydraulic conductivity of the watertight seal will not exceed 10^{-11} m/s.

The concrete plug shall be designed to resist the loads occurring during the sealing phase, i.e. the sum of the hydrostatic water pressure at repository depth and the swelling pressure from the watertight seal and backfill, and the occurring thermal loads. For these loads the deformation of the plug shall be limited and its tightness, i.e. bond between concrete and rock, preserved. To ensure that the concrete plugs will not be exposed to loads exceeding their strength an upper limit for the installed dry density of the backfill in the deposition tunnel section adjacent to the plug will be applied. The plug will be designed and constructed according to conventional procedures. It is anticipated that this will result in the specified properties.

11 References

SKB's (Svensk Kärnbränslehantering AB) publications can be found at www.skb.se/publications.

Buffer production report, SKB 2010. Design, production and initial state of the buffer. SKB TR-10-15, Svensk Kärnbränslehantering AB.

Design premises long-term safety, SKB 2009. Design premises for a KBS-3V repository based on results from the safety assessment SR-Can and some subsequent analyses. SKB TR-09-22, Svensk Kärnbränslehantering AB.

Repository production report, SKB 2010. Design and production of the KBS-3 repository. SKB TR-10-12, Svensk Kärnbränslehantering AB.

Underground openings construction report, SKB 2010. Design, construction and initial state of the underground openings. SKB TR-10-18, Svensk Kärnbränslehantering AB.

Börgesson L, Hernelind J, 2009. Mechanical interaction buffer/backfill. Finite element calculations of the upward swelling of the buffer against both dry and saturated backfill. SKB R-09-42, Svensk Kärnbränslehantering AB.

Dahlström L-O, 2009. Experiences from the design and installation of plug II in the Prototype. SKB R-09-49, Svensk Kärnbränslehantering AB.

Dahlström L-O, Johansson M, Magnusson J, Gueorguiev G, 2009. Feasibility study of a concrete plug made of low pH concrete. SKB R-09-34, Svensk Kärnbränslehantering AB.

Dixon D, Anttila S, Viitanen M, Keto P, 2008a. Tests to determine water uptake behaviour of tunnel backfill. SKB R-08-134, Svensk Kärnbränslehantering AB.

Dixon D, Lundin C, Örtendahl E, Hedin M, Ramqvist G, 2008b. Deep repository – engineered barrier systems. Half scale tests to examine water uptake by bentonite pellets in a block-pellet backfill system. SKB R-08-132, Svensk Kärnbränslehantering AB.

Gunnarsson D, Börgesson L, Hökmark H, Johannesson L-E, Sandén T, 2001. Äspö Hard Rock Laboratory. Report on the installation of the Backfill and Plug Test. SKB IPR-01-17, Svensk Kärnbränslehantering AB.

Gunnarsson D, Morén L, Sellin P, Keto P, 2006. Deep repository – engineered barrier systems. Assessment of backfill materials and methods for deposition tunnels. SKB R-06-71, Svensk Kärnbränslehantering AB.

Johannesson L-E, Nilsson U, 2006. Deep repository – engineered barrier systems. Geotechnical behaviour of candidate backfill materials. Laboratory tests and calculations for determining performance of the backfill. SKB R-06-73, Svensk Kärnbränslehantering AB.

Johannesson L-E, 2008. Backfilling and closure of the deep repository. Phase 3 – pilot tests to verify engineering feasibility. Geotechnical investigations made on unsaturated backfill materials. SKB R-08-131, Svensk Kärnbränslehantering AB.

Johannesson L-E, Sandén T, Dueck A, Ohlsson L, 2010. Characterization of a backfill candidate material, IBECO-RWC-BF. Baclo-Project – Phase 3. SKB R-10-44, Svensk Kärnbränslehantering AB.

Karnland O, Olsson S, Nilsson U, 2006. Mineralogy and sealing properties of various bentonites and smectite-rich clay minerals. SKB TR-06-30, Svensk Kärnbränslehantering AB.

Karnland O, 2010. Chemical and mineralogical characterization of the bentonite buffer for the acceptance control procedure in a KBS-3 repository. SKB TR-10-60, Svensk Kärnbränslehantering AB.

Keto P, Dixon D, Jonsson E, Börgesson L, Hansen J, Gunnarsson D, 2009. Assessment of backfill design for KBS-3V repository. SKB R-09-52, Svensk Kärnbränslehantering AB.

Olsson S, Karnland O, 2009. Characterization of bentonites from Kutch, India and Milos, Greece – some candidate tunnel backfill materials? SKB R-09-53, Svensk Kärnbränslehantering AB.

Sandén T, Börgesson L, Dueck A, Goudarzi R, Lönnqvist M, 2008. Deep repository – Engineered barrier system. Erosion and sealing processes in tunnel backfill materials investigated in laboratory. SKB R-08-135, Svensk Kärnbränslehantering AB.

SKB, 2006a. Long-term safety for KBS-3 repositories at Forsmark and Laxemar – a first evaluation. Main report of the SR-Can project. SKB TR-06-09, Svensk Kärnbränslehantering AB.

SKB, 2006b. Climate and climate-related issues for the safety assessment SR-Can. SKB TR-06-23, Svensk Kärnbränslehantering AB.

SKB, 2009. Design premises for a KBS-3V repository based on results from the safety assessment SR-Can and some subsequent analyses. SKB TR-09-22, Svensk Kärnbränslehantering AB.

SKB, 2010. Buffer, backfill and closure process report for the safety assessment SR-Site. SKB TR-10-47, Svensk Kärnbränslehantering AB.

Vogt C, Lagerblad B, Wallin K, Baldy F, Jonasson J-E, 2009. Low pH self compacting concrete for deposition tunnel plugs. SKB R-09-07, Svensk Kärnbränslehantering AB.

Wimelius H, Pusch R, 2008. Backfilling of KBS-3V deposition tunnels – possibilities and limitations. SKB R-08-59, Svensk Kärnbränslehantering AB.

Åkesson M, Börgesson L, Kristensson O, 2010. SR-Site Data report. THM modeling of buffer, backfill and other system components. SKB TR-10-44, Svensk Kärnbränslehantering AB.

Definitions used for describing clay material

To be able to describe the conditions of bentonite clay materials, several parameters and definitions are used in this report. The materials consist of solid particles and voids which can be partly filled with water (see Figure A-1). The volume of the material can be divided into the volume of the porous system ($V_p = V_w + V_g$) and the volume of the solid particles (V_s) and corresponding masses, m_w and m_s . From these definitions several other parameters describing the condition of a bentonite clay material can be defined. Some of the most common are listed in Table A-1 below.

Table A-1. Some definitions used for describing bentonite clay materials.

Parameter	Definition	Notes
Water content	$w = \frac{m_w}{m_s}$	Describes the amount of water in the bentonite.
Density of solid particles	$\rho_s = \frac{m_s}{V_s}$	This parameter varies with the type of soils. In this report the value measured for MX-80 2,780 kg/m ³ has been used, this is also assumed to be valid for the investigated backfill materials.
Density of the water	$\rho_w = \frac{m_w}{V_w}$	$\rho_w = 1,000 \text{ kg/m}^3$.
Dry density	$\rho_d = \frac{m_s}{V}$	Describes the density of the bentonite when all the voids are filled with gas.
Bulk density	$\rho = \frac{(m_w + m_s)}{V}$	
Density at saturation	$\rho_m = \frac{(\rho_w \times V_p + m_s)}{V}$	The density when the bentonite is fully saturated.
Degree of saturation	$S_r = \frac{V_w}{V_p}$	Describes the amount of the total pore volume which is filled with water.
Void ratio	$e = \frac{V_p}{V_s}$	The pore volume divided with the volume of the solid particles.
Porosity	$n = \frac{V_p}{V}$	The pore volume divided with the total volume of the sample.

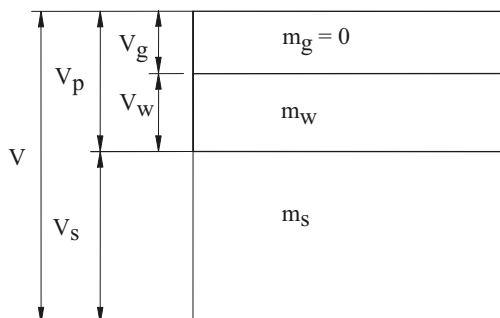

Figure A-1. A schematic drawing of the components of a sample of bentonite material.

Initial state of the variables used for the long term evolution of the backfill

For the assessment of the long-term safety a set of physical variables have been selected to allow an adequate description of the long-term evolution of the backfill /SKB 2010/. Initial state values for these variables can generally be derived from the designed and inspected backfill properties given in Table 6-1, or other information recorded during the production of the backfill. However, for some of the variables initial state values must be derived from other sources. In Table B2 the variables and corresponding designed and inspected backfill properties or other sources from which initial state values of the variables can be derived are presented.

Table B-1. Relation between the designed backfill properties and the variables used in the safety assessment. References to where, or how, initial state values of the variables not related designed backfill properties can be found or derived.

Variable	Backfill property	Source for initial state value
Water content	Material composition	–
Gas content		
Backfill material – composition and content		
Pore water composition		
Hydrovariables (pressure and flows)	Material composition	
Stress state	Installed density	
Pore geometry	Installed density	
Backfill geometry	Installed dimensions and geometrical configuration	
Temperature	–	Calculated
Structural and stray materials	–	Composition and amounts of materials used for rock support and grouting according to the reference design are given in the Underground openings construction report Table 4-1 and Table 4-2. The amounts of residual materials are given in the Underground openings construction report Table 4-3.

The following comments to how initial state values of the variables can be derived from the corresponding designed and inspected backfill properties can be made. For variables where the available data on the backfill material is limited, data from measurements on buffer materials have been used.

- **Water content:**
For the initial state this is the water content of the installed blocks and pellets. The water content of the material is defined as the mass of the water divided with the mass of the solid particles, see Appendix A.
- **Gas content:**
For the initial state this is the gas content of the installed blocks and pellets and in the voids (the volume of air in Table 6-2). The gas content of the blocks and pellets is related to the degree of saturation (S_r). The degree of saturation is defined as the volume of the water divided with the total pore volume of the material, see Appendix A. In order to be able to calculate the gas content the density of the solid particles is required.
- **Hydrovariables:**
The parameters of importance for the hydraulic properties of the unsaturated backfill material are the intrinsic permeability, the relative permeability, the vapour diffusion coefficient and the retention properties. These parameters depend on the type of bentonite, the density and the degree of saturation. The parameters are used to describe the thermo-hydro-mechanical properties of the

backfill. Their values and relation to the designed backfill properties are described in /Åkesson et al. 2010/. The parameter of importance for the hydraulic properties of the saturated backfill is the hydraulic conductivity. This parameter, among other things, depends on the bentonite type, the density, the temperature and the chemical composition of the pore water. The hydraulic conductivity and its relation to the designed backfill properties is described in /Karnland 2010/ and /Åkesson et al. 2010/.

- Backfill material – composition and content:

The composition of bentonite clays according to the reference design specified in Table 3-1 are described in detail in /Karnland 2010/ and involves the chemical composition, the density of the grains and the granule and grain size distribution. At this stage of development when a supplier has not yet been selected and no results from the production are available the variations in dominant cation, CEC and accessory minerals can be described by the specifications given in Table 3-2.

The montmorillonite composition can be analysed by extracting the clay fraction of the bentonite and investigate and describe the structural formula of the montmorillonite component, the layer charge and the cation exchange capacity. The analyses and relations between the designed buffer properties and these parameters are described in /Karnland 2010/.

- Pore water composition:

The pore water in the bentonite may change during and after the saturation. The composition of the pore water will depend on the compositions of the bentonite and groundwater in the surrounding rock. The relations between the designed backfill properties and the pore water composition are described in /Karnland 2010/.

- Pore geometry:

The pore geometry is related to the installed density. From the bulk density, water ratio and the density of the solid particles (ρ_s) it is possible to calculate the volume of the pores in the backfill. The pore volume of the backfill is normally described as the void ratio (e) which is defined as the pore volume divided with the volume of the solid particles or as the porosity (n) which is defined as the pore volume divided with the total volume of the sample, see Appendix A.

- Stress state:

Parameters for describing the stress state and strength of the backfill are important for determining the thermo-hydro-mechanical behaviour of the backfill both for the unsaturated and the saturated state. The parameters depend on the bentonite type, the density, the temperature and the chemical composition of the pore water. Examples of important parameters are the swelling pressure, shear strength, tensile strength, elastic properties and plastic properties. The parameters and their relation to the designed backfill properties are described in /Åkesson et al. 2010/. The swelling pressure is also described in /Karnland 2010/.

- Backfill geometry:

The geometry of the backfill depends on the geometry of the deposition tunnel and upper part of the deposition hole, this is discussed in Section 6.1.4

Glossary of abbreviations and branch terms

The glossary is intended to explain some abbreviations and branch terms used in this report. It is not intended to contain all technical terms found in the report. Chemical formulae and units are not included in the glossary.

CEC	Cation exchange capacity.
granule	Aggregations of finer clay materials that are produced through mining and processing of raw cla.
IBECO-RWC-BF	Product name of lowgrade bentonite from Milos.
MX-80	Product name of sodium bentonite from Wyoming.
SR-Can	Report on long-term safety of the final repository (published by SKB in November 2006).
SR-Site	Report on long-term safety of the final repository.
barrier	See the Repository production report Section, 1.5.
barrier function	-”-
design parameter	-”-
design premises	-”-
initial state	-”-
reference design	-”-