

International  
Progress Report

**IPR-03-32**

# Äspö Hard Rock Laboratory

## Status Report January - March 2003

Svensk Kärnbränslehantering AB

September 2003

**Svensk Kärnbränslehantering AB**

Swedish Nuclear Fuel  
and Waste Management Co  
Box 5864  
SE-102 40 Stockholm Sweden  
Tel +46 8 459 84 00  
Fax +46 8 661 57 19



**Äspö Hard Rock  
Laboratory**

Report no.  
IPR-03-32

Author  
Karin Pers  
(comp.)

Checked by

Approved  
Christer Svemar

No.  
F50K  
Date  
Sept. 2003

Date

Date  
2003-09-26

# Äspö Hard Rock Laboratory

## Status Report January - March 2003

Svensk Kärnbränslehantering AB

September 2003

*Keywords:* Äspö HRL, Status Report

This report concerns a study which was conducted for SKB. The conclusions and viewpoints presented in the report are those of the author(s) and do not necessarily coincide with those of the client.

## **Overview**

The Äspö Hard Rock Laboratory (HRL) constitutes an important part of SKB's work to design and construct a deep geological repository for spent nuclear fuel and to develop and test methods for characterisation of a suitable site.

The plans for SKB's research and development of technique during the period 2002–2007 are presented in SKB's RD&D-Programme 2001 /SKB, 2001a/. The information given in the RD&D-Programme related to Äspö HRL is annually detailed in the Äspö HRL Planning Report /SKB, 2003/.

This Äspö HRL Status Report is a collection of the main achievements obtained during the first quarter 2003.

### ***Technology***

One of the goals for Äspö HRL is to demonstrate technology for and function of important parts of the repository system. This implies translation of current scientific knowledge and state-of-the-art technology into engineering practice applicable in a real repository. A number of large-scale field experiments and supporting activities are therefore conducted at Äspö HRL: Canister Retrieval Test, Prototype Repository, Backfill and Plug Test, Long Term Test of Buffer Material, Cleaning and sealing of investigation boreholes, Low-pH cementitious products, KBS-3 method with horizontal emplacement, Large Scale Gas Injection Test, Temperature Buffer Test, New experimental sites, and Learning from experiences.

### ***Geo-science***

Geo-scientific research is a natural part of the activities at Äspö HRL. Studies with the major aims to increase the understanding of the rock mass material properties and to increase the knowledge of measurements that can be used in site investigations are important activities: GeoMod, Rock stress measurements, Rock creep, Äspö Pillar Stability Experiment, Heat transport, Seismic influence on the groundwater system, and Inflow predictions.

### ***Natural barriers***

At Äspö HRL experiments are performed at conditions that are expected to prevail at repository depth: Tracer Retention Understanding Experiments (TRUE Block Scale Continuation and TRUE-1 Continuation), Long Term Diffusion Experiment, Radionuclide Retention Experiments, Colloid Project, Microbe Project, Matrix Fluid Experiment, and PADAMOT.

Tests of models for groundwater flow, radionuclide migration and chemical/biological processes are one main purpose of the Äspö HRL. The major project is the Äspö Task Force on Modelling of Groundwater Flow and Transport of Solutes.

### ***Äspö facility***

An important part of the Äspö facility is the administration, operation, and maintenance of instruments as well as development of investigation methods. Other issues are to keep the stationary hydro monitoring system (HMS) continuously available and to carry out the programme for monitoring of groundwater head and flow and the programme for monitoring of groundwater chemistry.

### ***International co-operation***

The Äspö HRL has so far attracted considerable international interest. Seven organisations from six countries participate during 2003 in the co-operation in addition to SKB. In addition, SKB takes parts in several EC-projects and is through the Repository Technology department co-ordinating three EC-contracts.

# Contents

<b>1</b>	<b>General</b> .....	<b>5</b>
<b>2</b>	<b>Technology</b> .....	<b>6</b>
2.1	Canister Retrieval Test.....	6
2.2	Prototype Repository .....	7
2.3	Backfill and Plug Test.....	9
2.4	Long Term Test of Buffer Material.....	10
2.5	Cleaning and sealing of investigation boreholes .....	11
2.6	Low-pH cementitious products .....	12
2.7	KBS-3 method with horizontal emplacement.....	13
2.8	Large Scale Gas Injection Test .....	13
2.9	Temperature Buffer Test .....	14
2.10	New experimental sites .....	15
2.11	Learning from experiences .....	15
2.12	Task Force on Engineered Barrier Systems .....	15
<b>3</b>	<b>Geo-science</b> .....	<b>16</b>
3.1	GeoMod Project .....	16
3.2	Rock stress measurements.....	17
3.3	Rock creep .....	17
3.4	Äspö Pillar Stability Experiment .....	18
3.5	Heat transport.....	19
3.6	Seismic influence on the groundwater system .....	19
3.7	Inflow predictions.....	20
<b>4</b>	<b>Natural barriers</b> .....	<b>21</b>
4.1	Tracer Retention Understanding Experiments .....	21
4.1.1	TRUE Block Scale .....	22
4.1.2	TRUE Block Scale Continuation .....	22
4.1.3	TRUE-1 Continuation .....	22
4.2	Long Term Diffusion Experiment.....	23
4.3	Radionuclide Retention Experiments .....	24

4.4	Colloid Project .....	25
4.5	Microbe Project .....	26
4.6	Matrix Fluid Chemistry.....	28
4.7	Task Force on Modelling of Groundwater Flow and Transport of Solutes .....	29
4.8	PADAMOT.....	31
<b>5</b>	<b>Äspö facility .....</b>	<b>32</b>
5.1	Facility operation .....	32
5.2	Hydro Monitoring System .....	32
5.3	Programme for monitoring of groundwater head and flow .....	33
5.4	Programme for monitoring of groundwater chemistry .....	33
<b>6</b>	<b>International co-operation .....</b>	<b>34</b>
<b>7</b>	<b>Documentation .....</b>	<b>37</b>
7.1	Äspö International Progress Reports .....	37
7.2	Technical Documents and International Technical Documents.....	38
<b>8</b>	<b>References .....</b>	<b>39</b>

# 1 General

The Äspö Hard Rock Laboratory (HRL) constitutes an important part of SKB's work to design and construct a deep geological repository for spent nuclear fuel and to develop and test methods for characterisation of a suitable site.

One of the fundamental reasons behind SKB's decision to construct an underground laboratory was to create an opportunity for research, development and demonstration in a realistic and undisturbed rock environment down to repository depth. The underground part of the laboratory consists of a tunnel from the Simpevarp peninsula to the southern part of Äspö where the tunnel continues in a spiral down to a depth of 460 m. The rock volume and the available underground excavations have to be divided between the experiments performed at the Äspö HRL. Underground excavations at the 300–460 m levels and the allocation of experimental sites are shown in the figure below.

The Äspö HRL and the associated research, development, and demonstration tasks, managed by the Repository Technology Department within SKB, have so far attracted considerable international interest.

SKB's overall plans for research, development, and demonstration during the period 2002–2007 are presented in SKB's RD&D-Programme 2001 /SKB, 2001a/. The planned activities related to Äspö HRL are detailed on a yearly basis in the Äspö HRL Planning Report. The role of the Planning Report is also to present the background and objectives of each experiment and activity. This Status Report concentrates on the work in progress and refers to the Planning Report /SKB, 2003/ for more background information. The Annual Report will in detail present and summarise new findings and results obtained during the present year.

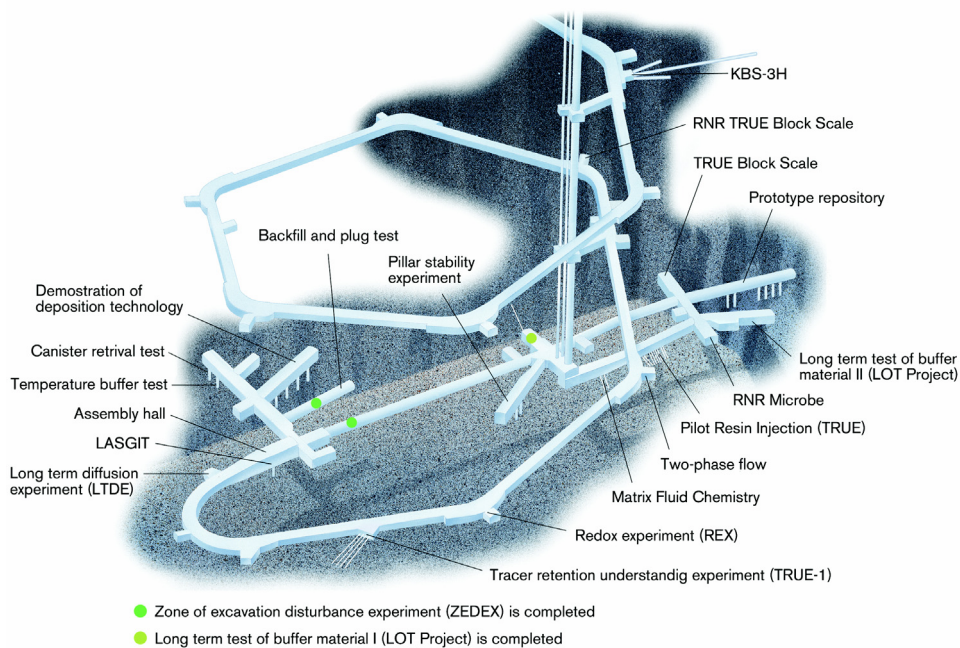

## 2 Technology

One of the goals for Äspö HRL is to demonstrate technology for and function of important parts of the repository system. This implies translation of current scientific knowledge and state-of-the-art technology into engineering practice applicable in a real repository. It is important that development, testing and demonstration of methods and procedures, as well as testing and demonstration of repository system performance, are conducted under realistic conditions and at appropriate scale. A number of large-scale field experiments and supporting activities are therefore conducted at Äspö HRL. The experiments focus on different aspects of engineering technology and performance testing, and will together form a major experimental programme.

### 2.1 Canister Retrieval Test

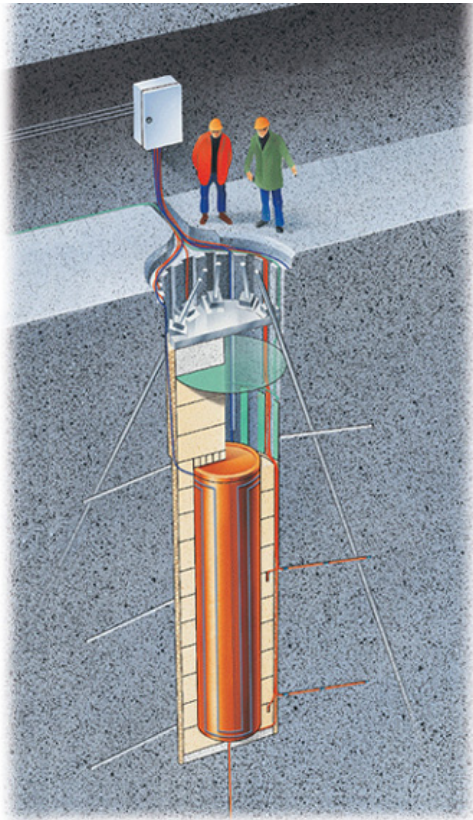

The Canister Retrieval Test is aiming at demonstrating the readiness for recovering of emplaced canisters also after the time when the bentonite is fully saturated.

In the Canister Retrieval Test two full-scale deposition holes have been drilled for the purpose of testing technology for retrieval of canisters after the buffer has become saturated.

These holes have been used for studies of the drilling process and the rock mechanical consequences of drilling the holes.

Canister and bentonite blocks were emplaced in one of the holes during 2000, the hole was sealed with a plug, heater turned on and artificial water supply to saturate the buffer started.

The test has been running for more than two years with continuous measurements of the wetting process, temperature, stresses, and strains.

#### **Achievements**

A large number of parameters are measured during the test to provide a basis for e.g. modelling purposes. Artificial water saturation of the bentonite has been continued during this quarter. The power of the heaters in the canister has been maintained at 2100 W, which is a reduction compared to the originally planned 2600 W, and the water pressure in the mats is maintained at 800 kPa. The collection of data measured during the test has continued. Data reports are published every third month.



## 2.2 Prototype Repository

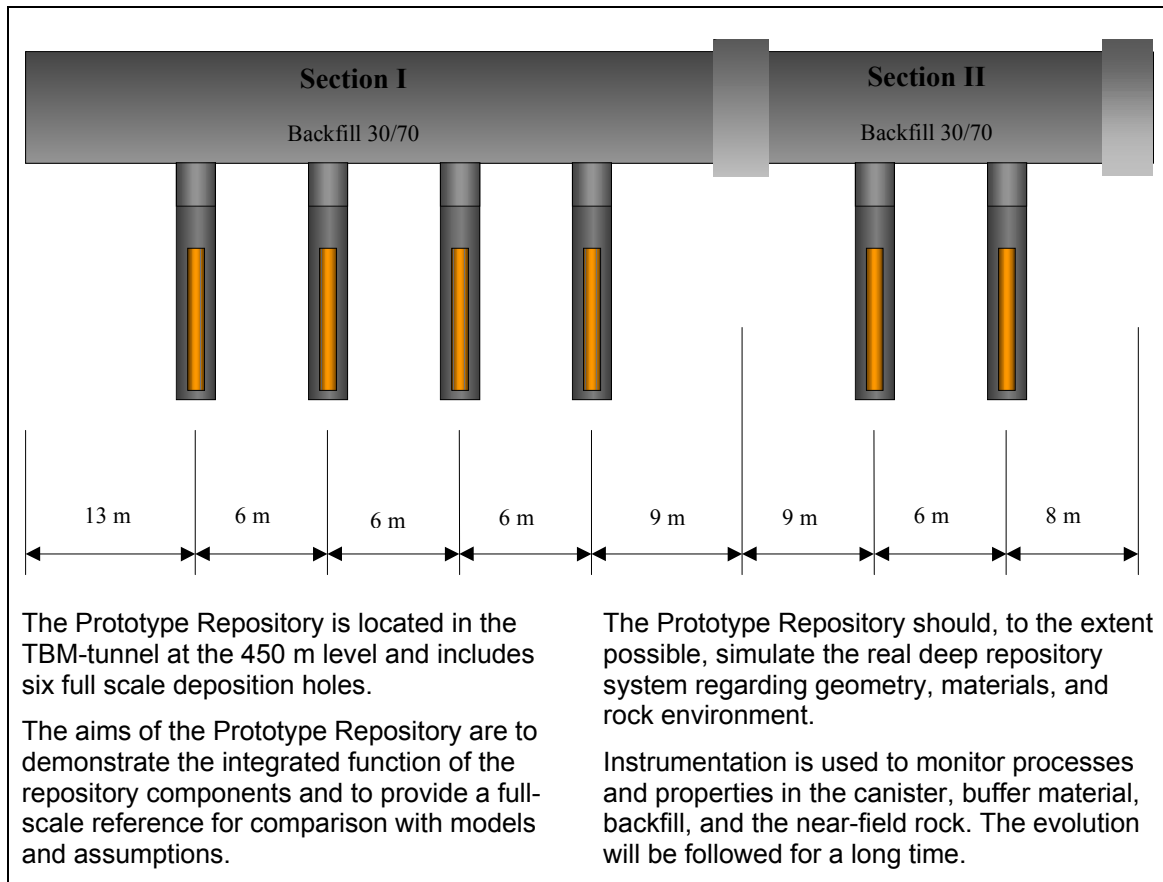

### **Achievements**

The inner section (Section I) was installed and the plug cast in 2001 and the heaters were turned on one by one. Since then the temperature, total pressure, pore pressure, relative humidity and resistivity in buffer and backfill is measured and registered to study the ongoing THM-processes. Data reports are published every third month.

In early 2002 a malfunction in the electrical insulation in the heaters to all four canisters was discovered and the installation of the two canisters in the outer section was postponed. An investigation showed that pyrolysis of the insulation material around cables to the heaters and water in the magnesium oxide in the heater elements caused an electrolytic mist. The mist decreases the electrical isolation toward the earth in the cold part at the top of the canister with insulation-free cables attached to the lead-through Gisma plugs. Another weak point was the lead-throughs in the lid themselves, which contain tephlo and epoxy, the latter material known to decrease its electrical insulation properties with increased temperature. Based on these findings a new design of the lead-throughs was developed and constructed and the installation of the outer section is now in progress. No specific action was deemed necessary to be taken in order to improve the operating conditions for the four installed canisters.

During this period the following activities has been performed in the outer section (Section II):

- The water flows into the tunnel are measured.
- Pressure build-up tests to characterise the rock mass in the vicinity of the plug.
- Installation of rock mechanic and geo-electric measuring equipments.
- Completion of cable lead-throughs between Section II and the G-tunnel.
- Drainage of the slot in which the plug will be casted and preparatory activities prior casting of the plug.
- Installation of bentonite buffer with measuring device in the two deposition holes (5 and 6), see Figure 2-1.
- Deposition of modified canisters in both deposition holes (March 26-27).

In addition, a meeting concerning the Prototype Repository EC-project was held at Äspö, March 25-27<sup>th</sup>.



*Figure 2-1 Deposition hole 5 in Section II of the Prototype Repository. The picture shows the top of the upper most bentonite block and cables which connect instruments in the bentonite block with the measuring units located in an adjacent tunnel.*

## 2.3 Backfill and Plug Test

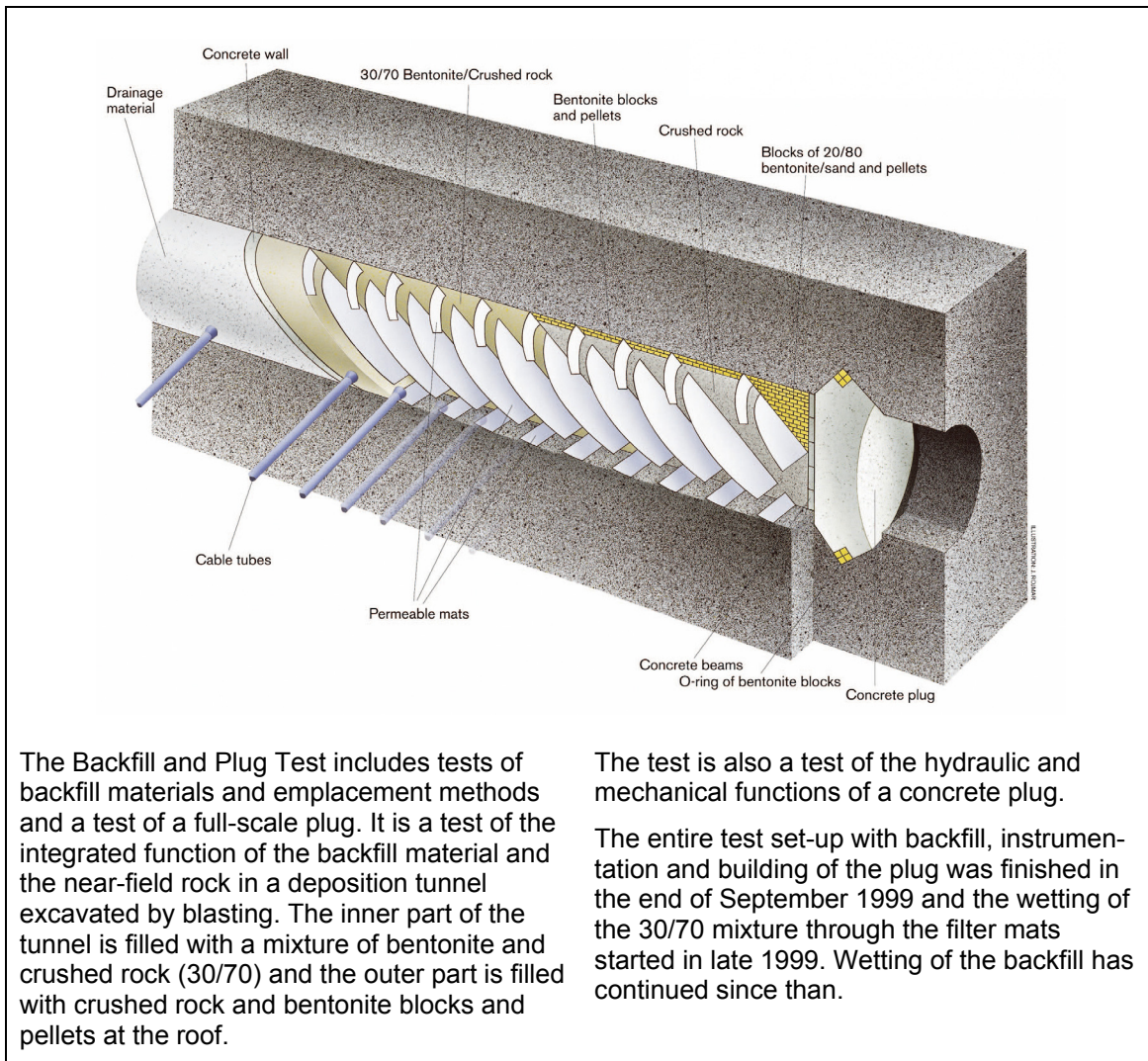

### **Achievements**

Wetting of the backfill from the filter mats and the rock has continued. The water pressure in all filters was increased in steps of 100 kPa to 500 kPa from October 2001 to January 2002. The water pressure in the permeable mats and the drained inner part of the drift has been kept constant at 500 kPa since then. Water saturation, water pressure and swelling pressure in the backfill and water pressure in the surrounding rock have been continuously measured and recorded. The results show that the backfill reached full saturation at the turn of the year 2002/2003. A decision was taken in March to shift to the next phase in the project which means preparation for and implementation of flow tests.

### **Planned work**

The strategy of the flow testing is in the first phase to successively decrease the water pressure in the mat sections (each section comprises three mats) starting with the mats at the plug. The flow from the mat section that still has 500 kPa pressure and the flow into the neighbouring mat section where the pressure just has been decreased will be

measured. The water pressure must be kept equal in the top, bottom and middle mats in each mat section in order to prevent water flow between the mats in a section. The pressure should be decreased in steps of 100 kPa and the hydraulic gradient kept for such long time that a steady flow could be observed.

The water flow to and from the two mats sections surrounding the tested backfill section will be measured separately in the three mats in the mat sections. If the measurements indicate that large air pockets are present in the backfill or mats it may be necessary to increase the water pressure in the mats to 1–2 MPa in order to reduce the influence of enclosed air.

## 2.4 Long Term Test of Buffer Material

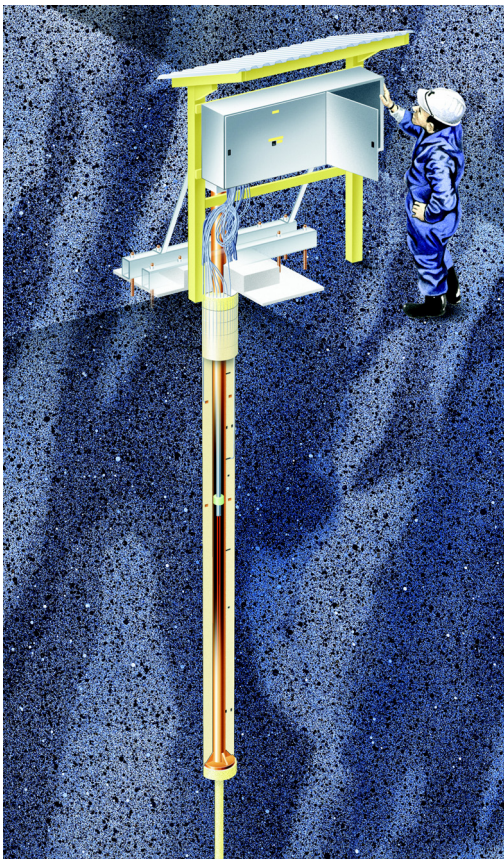

The Long Term Test of Buffer Material aims to validate models and hypotheses concerning physical properties in a bentonite buffer and of related processes such as bentonite degradation, microbiology, copper corrosion and gas transport in buffer material under conditions similar to those expected in a repository. Five 300 mm diameter test holes have been drilled and instrumented.

Five test parcels were installed in 1999. The intended test temperatures of 90°C and 130°C have been reached.

In 2001 a one-year parcel was extracted from the rock by overlapping core drilling. The remaining four long-term test parcels are planned to run for at least five years.

### ***Achievements***

The analysing work and testing with material from the extracted one-year parcel A0 is now completed and the reports are being prepared.

No new field activities were planned for during this period except control and calibration of the measuring equipment. The remaining four long-term test parcels have functioned well, and temperature, total pressure, water pressure and water content are continuously measured and registered every hour. The data are being checked monthly.

## 2.5 Cleaning and sealing of investigation boreholes



A project, with the aim to identify and to demonstrate, in field experiments, the best available techniques for cleaning and sealing of investigation bore holes, was initiated in 2002.

The first phase of this project comprises identification of available techniques, complementary laboratory experiments with potential sealing materials, and investigations of the status of two bore holes at Äspö.

The two bore holes are planned to be used for the demonstration of cleaning techniques, i.e. removing of lost equipment in the holes, and the subsequent demonstration of sealing techniques.

### ***Achievements***

The first Phase of this project is almost completed. A state of the art report summarising the developments of the sealing and cleaning techniques during the last 10–15 years has been put together. The report, titled “Borehole plugging – State of art”, will soon be printed.

A seminar concerning cleaning and sealing of boreholes, held at Äspö in February 26-27, was attended by representatives from SKB and the oil industry. A compilation and an evaluation of the seminar will be prepared. The detailed planning of the second phase of the project will be based on this work and additional viewpoints obtained at the seminar.

## 2.6 Low-pH cementitious products

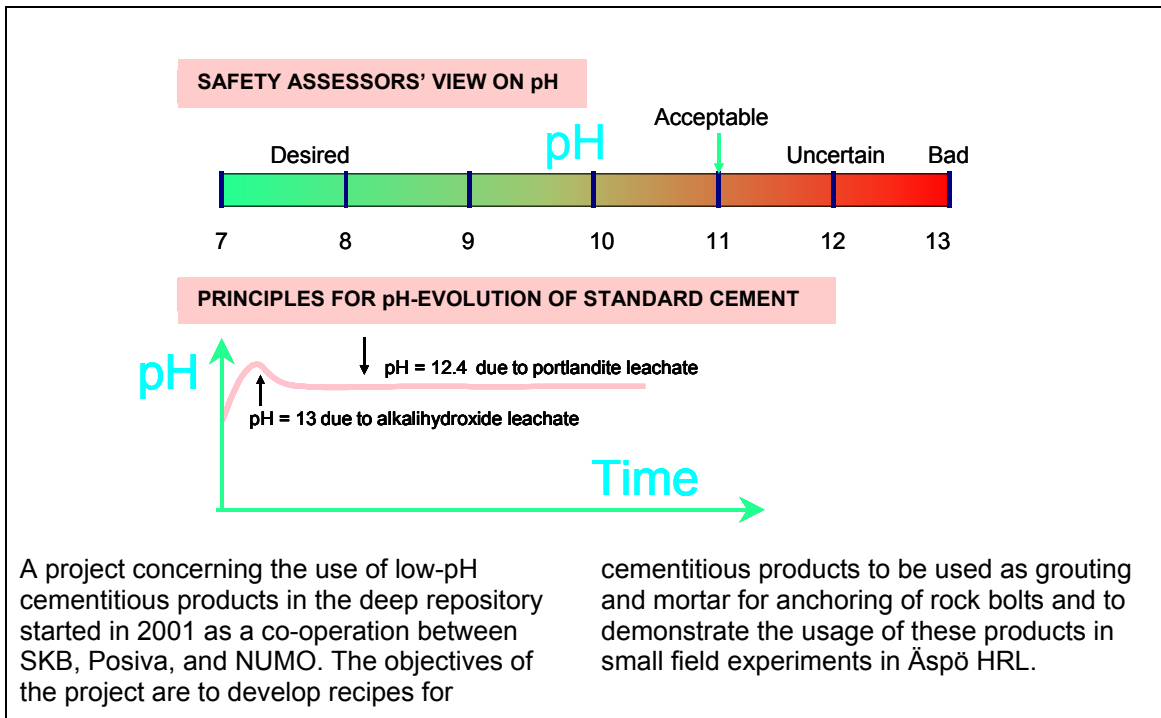

### **Achievements**

It has been more difficult than expected to find suitable injection grouts giving leachates with pH below 11. A small field test that was planned has been postponed and the focus is put on finding suitable recipes for injection grouts. It seems possible to grout fracture apertures down to approximately 100  $\mu\text{m}$  with cement based low-pH grouts. Finer fractures need other grouts, where silica sol and periclase (MgO) are strong candidate materials.

## 2.7 KBS-3 method with horizontal emplacement

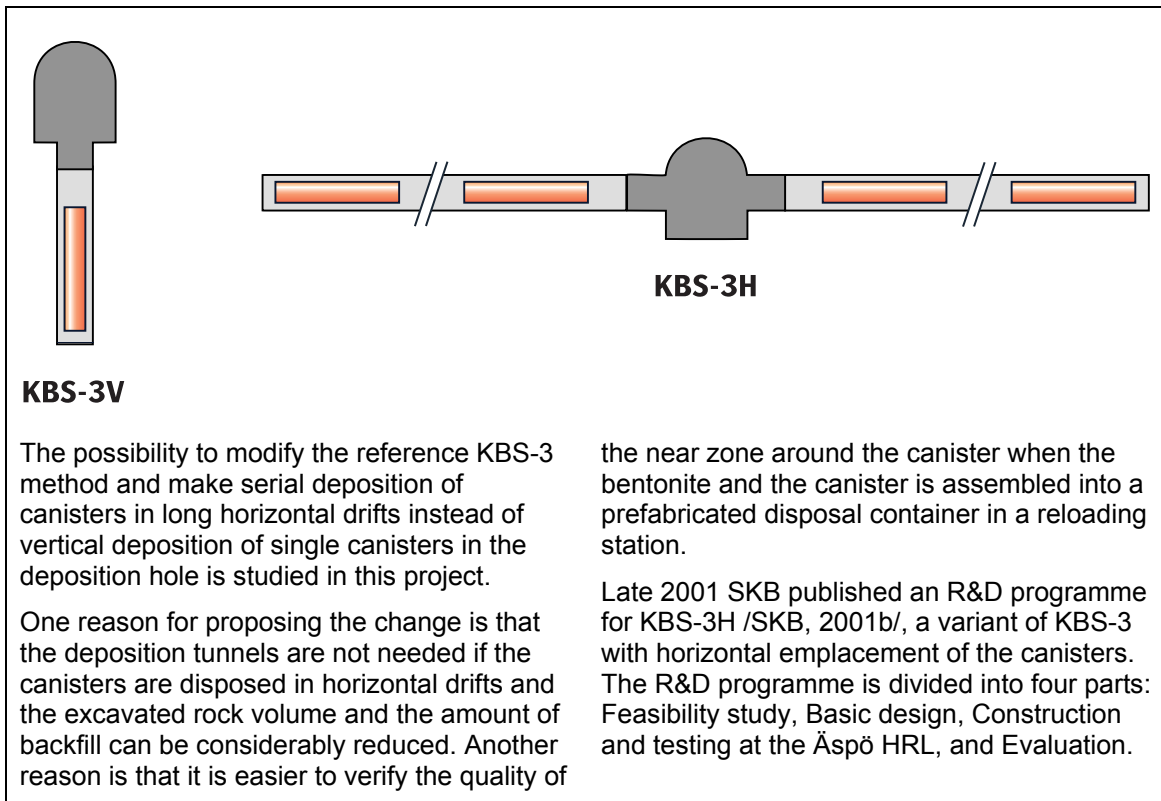

### KBS-3V

The possibility to modify the reference KBS-3 method and make serial deposition of canisters in long horizontal drifts instead of vertical deposition of single canisters in the deposition hole is studied in this project.

One reason for proposing the change is that the deposition tunnels are not needed if the canisters are disposed in horizontal drifts and the excavated rock volume and the amount of backfill can be considerably reduced. Another reason is that it is easier to verify the quality of

the near zone around the canister when the bentonite and the canister is assembled into a prefabricated disposal container in a reloading station.

Late 2001 SKB published an R&D programme for KBS-3H /SKB, 2001b/, a variant of KBS-3 with horizontal emplacement of the canisters. The R&D programme is divided into four parts: Feasibility study, Basic design, Construction and testing at the Äspö HRL, and Evaluation.

### **Achievements**

The Feasibility Study, which was finalised in October 2002, showed that the KBS-3H concept is worth further development from a technical, economical, and long-term safety point of view and the SKB board decided in December 2002 to continue the project with the next phase, the Basic Design.

The planning of the boring of the demonstration deposition drifts, grouting, and water loss measurements are finalised. The excavation of the niche is coordinated with the excavation work within the Äspö Pillar Stability experiment. The experiment will be located at 220 m depth at 1623-m tunnel length in the NASA tunnel. Excavation of the niche is planned to be finalised in June and the drilling of the deposition holes are expected to start in August.

Other parts of Basic Design include equipment for construction of deposition drifts and handling of the disposal container. The Project is carried out in co-operation with Posiva.

## 2.8 Large Scale Gas Injection Test

SKB has during several years performed a number of experiments with gas-injection on MX-80 bentonite. Today, there is relatively good understanding of the processes determining the gas transport. One remaining question is the importance of the scale. All bentonite experiments so far have been performed in the centimetre scale and the extrapolation of the results from these experiments to repository scale is unclear. Therefore, the Large Scale Gas Injection Test (LASGIT) has been initiated to perform a

number of large scale experiments to verify the existing results from the laboratory experiments.

The major aims of the project are to: (a) perform and evaluate full-scale gas injection tests, (b) answer questions related to up-scaling, (c) get additional information on gas-transport processes, (d) obtain high quality data for testing and validation of models.

The experiments will be performed in a bored deposition hole with a full-scale canister without heaters and a bentonite buffer installed in a new tunnel at Äspö HRL. Water will be artificially supplied to the buffer at isothermal conditions. When the buffer is fully saturated gas injection will start, first with small gas volumes and finally with a volume corresponding to a full-size canister.

### **Achievements**

The planning of the experiments and the preparations for the installation are in progress. No activities have so far taken place in Äspö HRL.

## **2.9 Temperature Buffer Test**

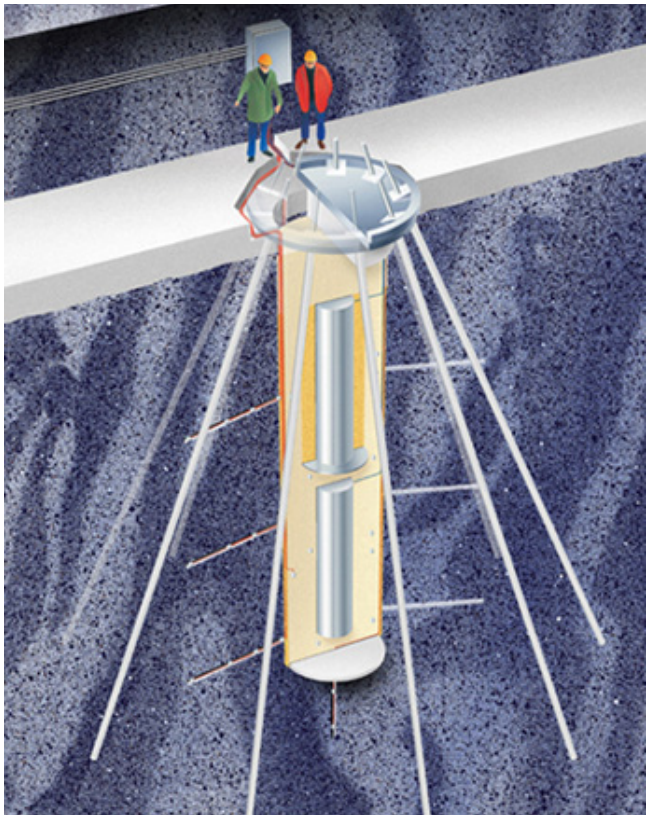
	<p>The French organisation ANDRA carries out the TBT at Äspö HRL in cooperation in SKB. The variable nature of the French geological environment requires research to be carried out to relax the temperature constraints on the dimensioning of clay engineered barriers in order to produce more compact designs.</p> <p>The aims of the Temperature Buffer Test (TBT) is to evaluate the benefits of extending the current understanding of the behaviour of engineered barriers to include high temperatures, above 100°C, and the experimental resources needed to achieve this. The test is located in the same test area as the Canister Retrieval Test, which is in the main test area at the 420 m level.</p> <p>Two canisters, 3 m long, with heaters are installed in the same deposition hole. The canisters are surrounded by a sand barrier and a bentonite barrier.</p>
--	--

### **Achievements**

The canisters with heaters, bentonite buffer, and sand infilling have been installed in the deposition hole together with a system for artificial watering and a large number of sensors and cables for registration of e.g. saturation, pressures and temperatures. The assembly of the steel lid and the casting of the concrete plug was carried out in March.



The operation of the test was initiated during week 13 with reduced heater effect. The heater effect has been increased in steps to full power. Data from the test is collected and subsequently transferred to the owner, ANDRA.

## **2.10 New experimental sites**

Several large-scale experiments are discussed, which need new tunnels or themselves comprises tunnel excavation. But, the use of explosives is known to cause disturbance in the hydraulic regime in the whole Äspö rock mass. In some cases the disturbance has been permanent. Another conflict with other experiments is that a penetration of a water-carrying fracture may change the hydraulic head in a large region around the place where the intersection takes place.

The major aim of this project is to find new experimental sites at Äspö HRL for three large-scale experiments: Äspö Pillar Stability Experiment (APSE), Testing of low-pH grout, and KBS-3 method with horizontal emplacement.

### ***Achievements***

The sites for both APSE and the KBS-3H experiment have been selected. The APSE site is located at the 450-m level and the site for the KBS-3H experiment is located in a niche at the 220-m level. The first testing of low-pH concrete for grouting and rock bolting will take place in an existing niche or tunnel.

## **2.11 Learning from experiences**

In this project, reference techniques for emplacement of buffer, canisters, backfilling, and closure are to be identified. Emplacement of buffer and canisters, and backfilling of tunnels have been experienced in Canister Retrieval Test, Prototype Repository and Backfill and Plug Test. These experiences are documented and the result analysed with respect to possible improvements as well as limits with respect to water inflows.

The work comprises:

- Compilation of the results from more than ten years of performed engineering experiments in Äspö HRL.
- Compilation and evaluation of experience from emplacement of buffer and canisters, backfilling of tunnels, and estimation of acceptable water inflows for the applied methods.

### ***Achievements***

A report describing the large series of experiments related to engineered barrier systems that have been conducted in SKB's underground laboratories and construction sites during the time period 1981 to 2003 is in preparation.

## **2.12 Task Force on Engineered Barrier Systems**

The Task Force on Engineered Barrier Systems is still on stand-by while the prioritised work on modelling of THMC-processes in the buffer during saturation is conducted on data from the Prototype Repository within the EC-project.

### 3 Geo-science

Geo-scientific research is a natural part of the activities at Äspö HRL. Studies with the major aims to increase the understanding of the rock mass material properties and to increase the knowledge of measurements that can be used in site investigations are important activities.

#### 3.1 GeoMod Project

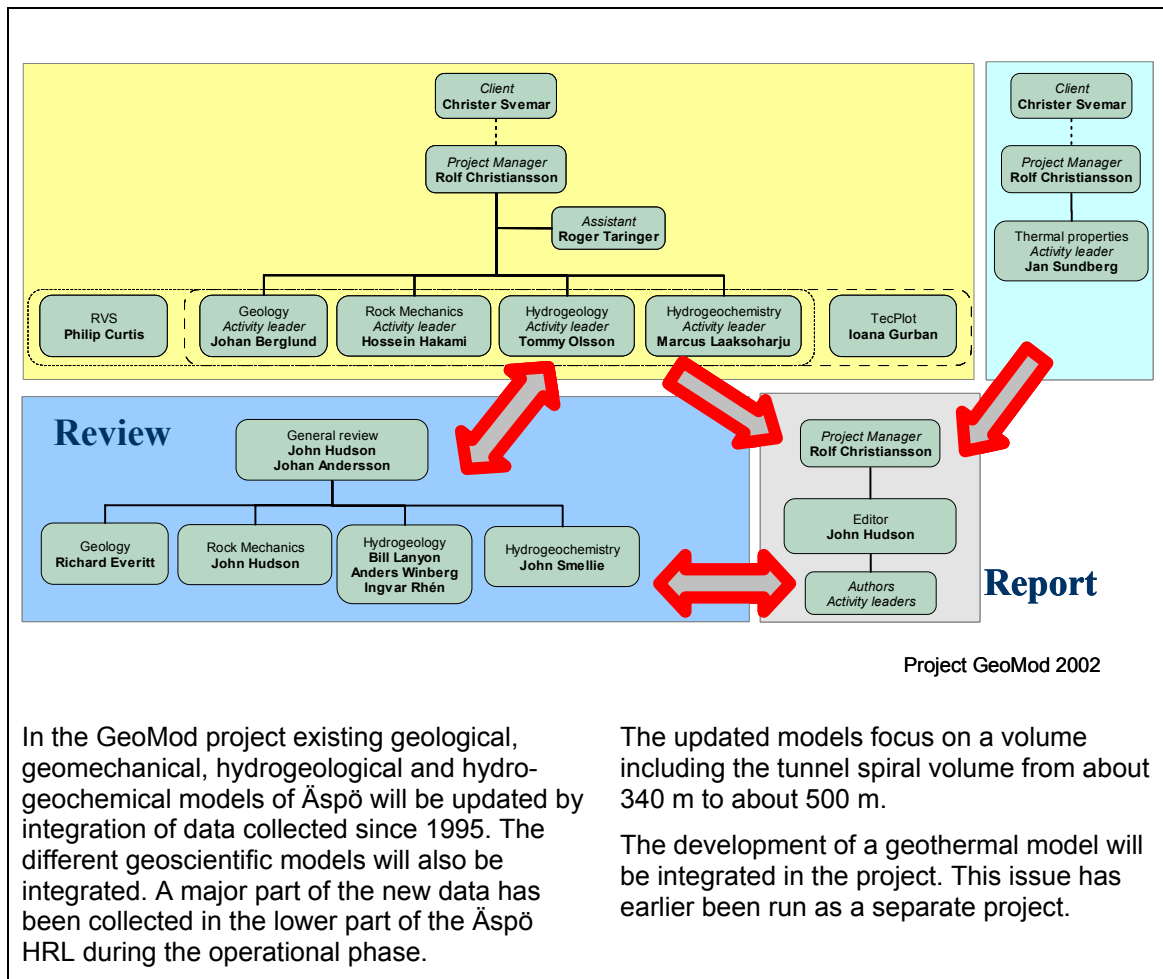

#### Achievements

The models within each geo-scientific discipline have been assessed and results from the different projects conducted at Äspö has been utilised to modify or update the models. The reporting of the different geo-scientific disciplines is in progress.

The reporting of the developed methodology for integration of the modelling results obtained from the different geo-scientific disciplines is also in progress. A predicted substantial overdraw of the project’s budget has however, raised the discussion of how detailed the finalisation of the project shall be.

## **3.2 Rock stress measurements**

To be able to make correct assessments of the *in situ* stress field from results from different types of rock stress measurement techniques it is important to know the limitations and shortcomings of the different measurement techniques. Rock stress measurements with different techniques (bore probe, doorstopper and hydraulic fracturing) have during the years been performed as well as numerical modelling of the stress. The strategy for rock stress measurements will be presented in a report.

### **Achievements**

A co-operation between SKB and POSIVA with the objective to quality assure overcoring data has been initiated. The first phase which includes development of a numerical tool for isotropic and elastic conditions has been completed. The first phase is presented in a POSIVA report.

Draft versions of, all articles that SKB will contribute with in the special issue of the International Journal of Rock Mechanics and Mining Sciences where ISRM's suggested strategy for rock stress measurements, is available. The special issue is going to conclude the current status for SKB's strategy for rock stress determination.

## **3.3 Rock creep**

The understanding of the material properties of rock and rock-mass is being developed. The objective with the work is to be able to develop better conceptual models for the influence of the rock damaged zone and rock creep on rock stability.

A literature study and scoping numerical modelling with a three-dimensional coupled hydromechanical computer code (3DEC) have been performed. The results from the modelling and the literature study will be presented in a report.

### **Achievements**

The literature study is almost completed.

Work has been initiated to study the possibility to simulate the effect of earth-quakes on individual fractures. Modelling is carried out by two different consultants. The key issue is to trigger the dynamic effect in the numerical model.

### 3.4 Äspö Pillar Stability Experiment

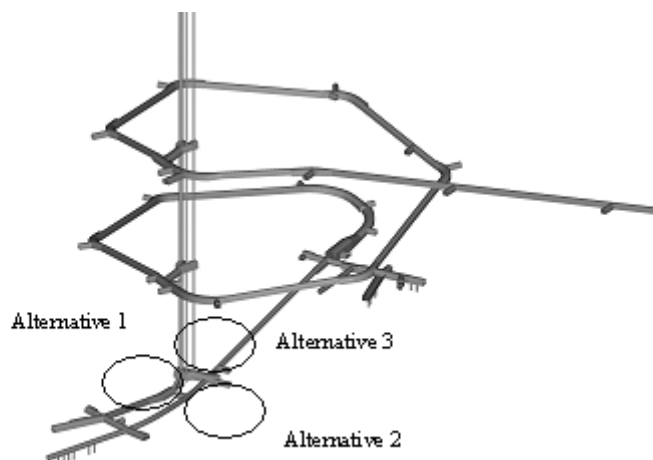

A Pillar Stability Experiment has been initiated to complement an earlier study performed at URL in Canada. The major aims are to demonstrate the capability to predict spalling in fractured rock mass and the effect of backfill on the propagation of micro cracks. In addition, the capabilities of two- and three-dimensional mechanical and thermal predictions will be compared.

A new short tunnel will be excavated in Äspö HRL to ensure that the experiment is carried out in a rock mass with a virgin stress field. The selected site is at the 450 m level (Alternative 3 in the figure above).

The pillar will be created between two vertical holes drilled in the floor of the tunnel. When the pillar is heated spalling will occur.

#### **Achievements**

The feasibility study of the experiment is presented by Andersson /2003/. A report describing the geology and the rock mass properties in a 200 m domain that includes the three alternatives /Staub et al., 2003/ and a report describing the hydrogeological characterisation / Fransson, 2003/ has both been published. These two reports conclude the general description of the experiment site. The preliminary modelling using general parameters has been finished and is presented in IPR-reports / Staub et al., 2003; Fredriksson et al., 2003, Wanne and Johansson, 2003; Rinne et al., 2003; Fransson, 2003/. The final modelling will be made when laboratory data from tests on cores is available in the autumn of 2003.

The selection of entrepreneur for the excavation of the tunnel is in progress and the excavation is scheduled to start in mid April 2003.

The vibrations induced in the rock mass from the blasting during the excavation are a concern since other experiments and their instrumentation may not to be damaged. Peak values for vibration and acceleration have been set, and an extensive monitoring programme will follow the excavation. In addition, vibration measurements will be performed at the surface and at different locations in the tunnel system to study how the vibrations are affected by changes in geology, deformation zones etc.

The design of the liner, which is intended to simulate the confining pressure in the backfill, has been modified but not yet tested. These tests are scheduled to April.

## **Fracture modelling**

SKB has supported development of the FRACOD-code. FRACOD is a 2D computer code designed to simulate fracture initiation and propagation in elastic and isotropic rock mediums. The code employs the Displacement Discontinuity Method (DDM) principles. It predicts the fracturing process including fracture failure, fracture propagation and fracture initiation in intact rock. The code is one of the ones used for the modelling of the Äspö Pillar Stability Experiment, APSE.

## **3.5 Heat transport**

The aim with this project is to develop a strategy for site descriptive thermal modelling and to use the strategy to develop and test a thermal model for the Äspö Rock volume. The work includes measurements of thermal properties of the rock and examination of the distribution of thermal conductivities. Another aim is to analyse the thermal properties in different scales and clarify relevant scales for the thermal process by sensitivity analyses.

### ***Achievements***

The model development strategy, the analysis of distribution and scaling factors and measured thermal properties at Äspö HRL are reported in three reports:

- Thermal Site Descriptive Model – a strategy for the model development during site investigations /Sundberg, 2003a/.
- Thermal properties at Äspö HRL. Analysis of distribution and scale factors /Sundberg, 2003/.
- Comparison of thermal properties measured with different methods (in press).

The development of a site descriptive thermal model for Äspö HRL has been integrated in the GeoMod Project, see section 3.1.

## **3.6 Seismic influence on the groundwater system**

The Hydro Monitoring System (HMS) registers at the moment the piezometric head in 409 positions underground in the Äspö HRL. An induced change of the head with more than 2 kPa triggers an intensive sampling. All measured data are stored in a database.

The data in the database are assumed to bear witness of different seismic activities in Sweden but also abroad, dependent on the magnitude of the event. By analysing the data on changes in the piezometric head at Äspö connections to specific seismic events are expected to be established.

### ***Achievements***

Data from the HMS are stored in the database pending analysis.

### **3.7 Inflow predictions**

SKB has conducted a number of large field tests where prediction of inflow into tunnels or depositions holes has been a component; the Site Characterisation and Validation Test in Stripa, the Prototype Repository and the Groundwater Degassing and Two-Phase Flow experiments in Äspö HRL. The results from these tests show that when going from a bore hole to a larger diameter hole, the inflow into the larger hole is often less than predicted, and the explanation for this is not yet well understood.

The major objectives with this project are to make better predictions of the inflow of groundwater into deposition holes, to confirm (or refuse) previous observations of reduced inflow into deposition holes and tunnels compared with boreholes, and also to identify the different mechanisms determining the inflow and quantify their importance.

#### ***Achievements***

A preliminary project plan for the large-field test at Äspö HRL has been prepared. Ongoing activities are numerical modelling and planning for the field test.

## 4 Natural barriers

At the Äspö HRL experiments are performed at conditions that are expected to prevail at repository depth. The experiments are related to the rock, its properties, and *in situ* environmental conditions. The goals are to increase the scientific knowledge of the safety margins of the deep repository and to provide data for performance and safety assessment and thereby clearly present the role of the geosphere for the barrier functions: isolation, retardation and dilution. Tests of models for groundwater flow, radionuclide migration and chemical/biological processes are one of the main purposes of the Äspö HRL. The programme includes projects with the aim to evaluate the usefulness and reliability of different models and to develop and test methods for determination of parameters required as input to the models

### 4.1 Tracer Retention Understanding Experiments

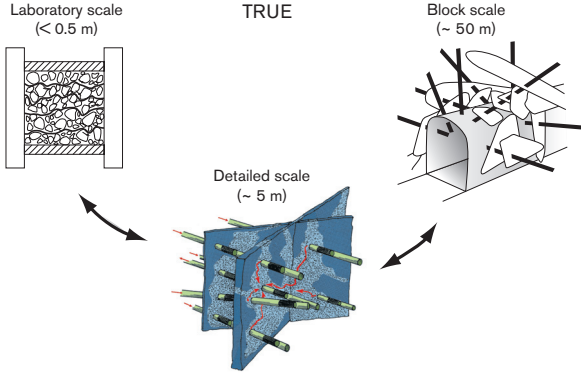

Tracer tests with non-sorbing and sorbing tracers are carried out in the TRUE family of projects. These are conducted at different scales; laboratory scale (< 0.5 m), detailed scale (<10 m) and block scale (up to 100 m) with the aim to improve understanding of transport and retention in fractured rock. The work includes building of hydrostructural models and conceptual microstructure models. Numerical models are used to assess the relative contribution of flow-field related effects and acting processes (diffusion and sorption) on *in situ* retention.

The first *in situ* experiment (TRUE-1) performed in the detailed scale and the TRUE Block Scale series of experiments have come to their respective conclusion. Complementary field work and modelling are currently performed or being planned as part of two separate but closely coordinated continuation projects.

The TRUE Block Scale Continuation project aims at obtaining additional understanding of the TRUE Block Scale site.

The TRUE-1 Continuation project is a continuation of the TRUE-1 experiment. According to present plans the TRUE-1 site will be injected with resin and excavated and analysed. The objectives are to obtain insight in the internal structure of the investigated feature and to study fixation of sorbing radioactive tracers.

Prior to the application of resin injection technology in Feature A complementary hydraulic and tracer tests are performed to better understand Feature A and its relation to the surrounding fracture network. In addition, a dress rehearsal of *in situ* resin injection is realised through a characterisation project focused on fault rock zones. Furthermore, attempts are made to assess fracture apertures using radon concentrations in groundwater.

#### 4.1.1 TRUE Block Scale

##### **Achievements**

The experimental work for TRUE Block Scale project was “officially” terminated in November 2000. Evaluation and final reporting was mainly completed during 2002. The TRUE Block Scale project is reported in a series of four final report volumes /Andersson *et al.*, 2002a; Andersson *et al.*, 2002b; Poteri *et al.*, 2002; Winberg *et al.*, 2003/.

The contributions from the different project teams will be reported in International progress reports.

#### 4.1.2 TRUE Block Scale Continuation

##### **Achievements**

The TRUE Block Scale Continuation (BS2) project is focussed on the existing TRUE Block Scale site. The TRUE Block Scale Continuation is divided into two separate phases:

- BS2a Continuation of the TRUE Block Scale (Phase C) pumping and sampling till the end of 2002 including employment of developed enrichment techniques to lower detection limits. Complementary modelling work in support of *in situ* tests.
- BS2b Additional *in situ* tracer tests based on the outcome of the BS2A analysis. *In situ* tests are preceded by reassessment of the need to optimise/remediate the piezometer array. The specific objectives of BS2b are to be formulated on the basis of the outcome of BS2a.

The project plan for the modelling within phase BS2a was established in February and a version of the hydrostructural model updated to the latest RVS-version was established. Possible pathways for injected tracers are being compiled and based on this compilation, model simulations of network long flowpaths and involving background fractures have been performed. These simulations constitute a base for evaluating the need for remediation of the piezometric array. The selection of suitable tracer is also addressed.

##### **Planned work**

The work planned in the near future is:

- Continued modelling of effects of various types of heterogeneity in the vicinity of the flow paths.
- Planning and Preparatory work for the *in situ* experiments.

#### 4.1.3 TRUE-1 Continuation

##### **Achievements**

The TRUE-1 Continuation project is a continuation of the TRUE-1 experiments, and the experimental focus is mainly on the TRUE-1 site.



In the case of the Fault Rock Zone Characterisation subproject, laboratory experiments to test resins and dye additives have been performed. The experiments indicate good penetration of the employed resins also at low temperature (12°C). A decision to drill about 16 characterisation/injection boreholes, 3-6 m deep, was taken in March and drilling has commenced.

Initial experimental activities performed in order to investigate the possibility of assessing fracture apertures from radon concentrations in groundwater have been performed earlier /Byegård 2002/. The continuation of this part of the project comprises planning of in situ experiments.

## 4.2 Long Term Diffusion Experiment

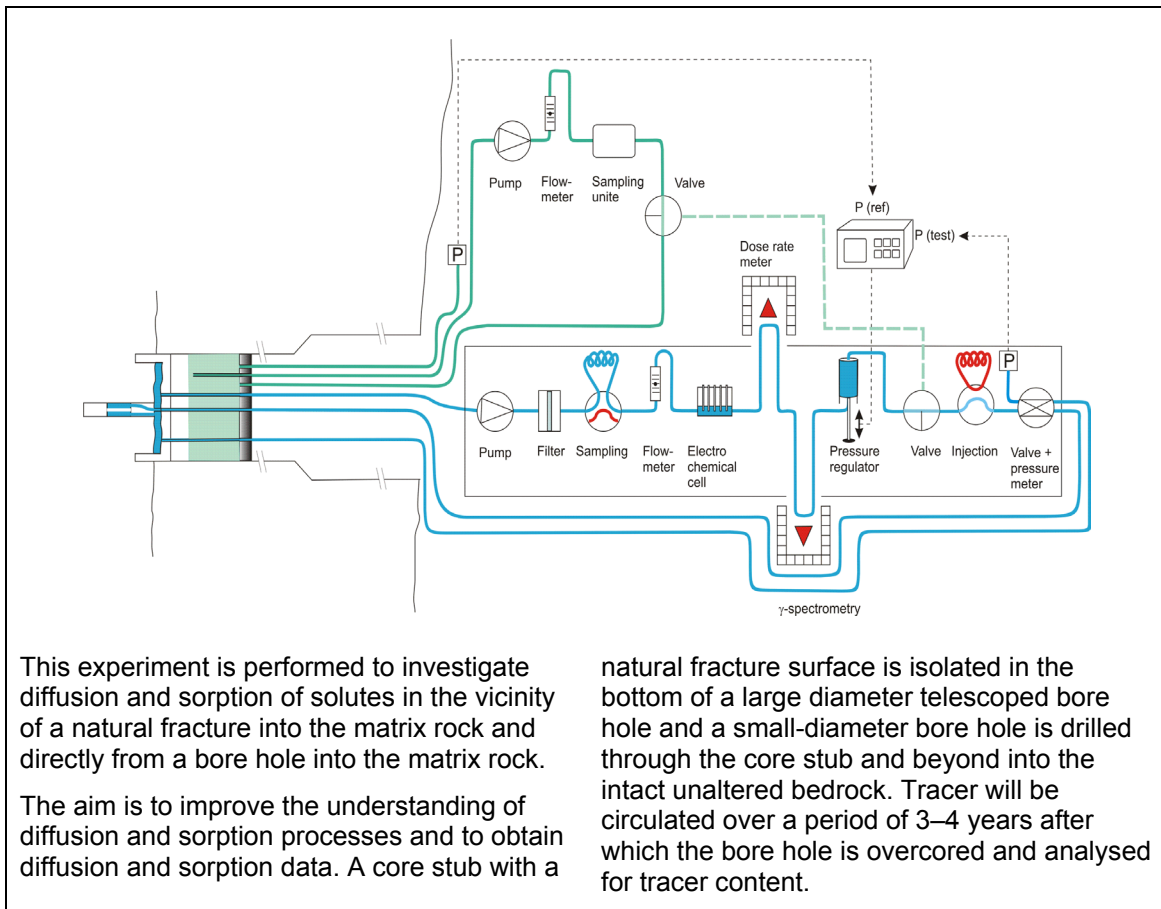

### Achievements

The activities in the project during this time period have focused on investigations on identified problem issues. Considerable concern has been put on how the excavation of new tunnels will influence the water pressure conditions in the LTDE experiment and how other possible fast changes caused by e.g. accidents can influence the long-term experiment when it has been initiated. As a consequence of the investigations large efforts will be spent on preparation of a test programme to control the behaviour of the borehole instrumentation under extreme conditions. Another concern is the influence of occurring microbes and precautions will be taken to avoid uncontrolled build-up of bacteria and the formation of bio-films.

## 4.3 Radionuclide Retention Experiments

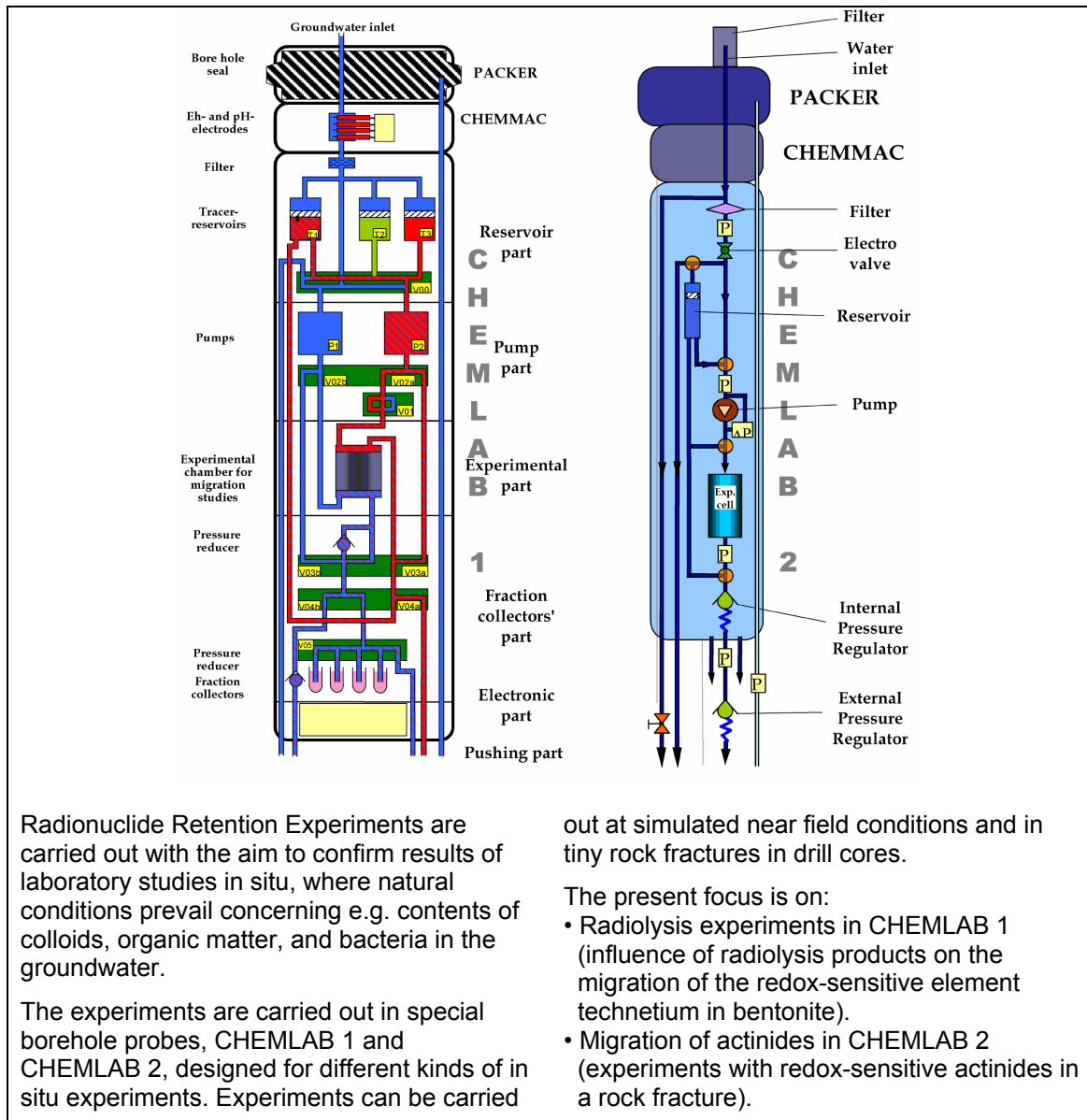

### Achievements

#### Radiolysis experiments

In the end of 2002, two kinds of radiolysis experiments were started. In one the water will be irradiated before it comes in contact with the cell. The radicals produced from water radiolysis will not reach the experiment cell, but the molecular products ( $H_2O_2$ ,  $O_2$ , and  $H_2$ ) will influence the redox chemistry of the experimental cell. In the other type of experiment the irradiation source will be placed in the experiment cell, close to the reduced technetium, and thereby the radicals produced will play a role. Both radiolysis experiments are running according to plan and will be terminated in the beginning of April 2003. The experiments will be followed by analyses.

## Migration of actinides

In these experiments a cocktail containing actinides is added to the groundwater before pumping it through a longitudinal natural fracture in a drill core placed in CHEMLAB 2. The first experiment carried out in CHEMLAB 2 comprised migration of the actinides: americium, neptunium, and plutonium. The second experiment was carried out in the beginning of 2002 and the results has been evaluated and published /Römer *et al.*, 2002/.

The third actinide experiment in Äspö HRL was started at the end of 2002. This experiment was expired due to several technical problems with CHEMLAB 2. The expired experiment however provided a few water samples which will be analysed by FZK/INE. The experiment was restarted in mid February and will be in operation until the beginning of April.

The preparation of a fourth actinide experiment, to be started in the autumn, is in progress.

## 4.4 Colloid Project

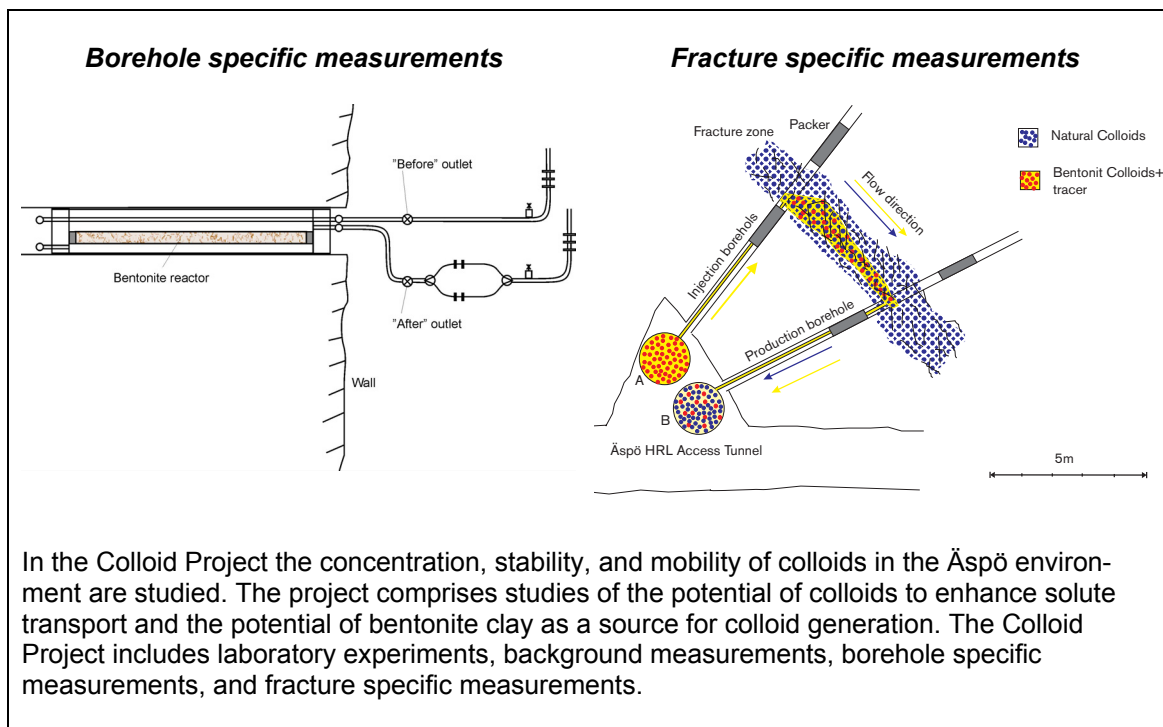

### Achievements

The final reporting of the laboratory experiments and the background measurements is in progress.

The laboratory experiments carried out in order to optimise the design of the "bentonite reactor" (filter textile with bentonite clay) to be used in the borehole specific measurements are finalised. The installations of the equipment in the four boreholes in the Äspö tunnel and the two boreholes at Olkiluoto have been successful. The field experiment started in January and will be finalised in April. During the measurements

the groundwater is in contact with the bentonite clay adapted in the “bentonite reactors” in the boreholes and the colloid content in the water is measured prior and after it has been contact with the bentonite clay. The colloid content is measured by using conventional filtering and ultra filtration. The colloid concentrations were measured for the first time in February, the second measurements were performed in March, and the third and final measurements will be carried out in April.

## 4.5 Microbe Project



The Microbe Project has been initiated in the Äspö HRL for studies of the microbial activity in groundwater at in situ conditions. The major aims are to study: bio-mobilisation of radionuclides, bio-immobilisation of radionuclides, microbial effects on the chemical stability of deep groundwater environments, and microbial corrosion of copper.

The main MICROBE site is on the 450-m level where a laboratory container has been installed with laboratory benches, an anaerobic gas box and an advanced climate control system. Three core drilled holes, KJ0050F01, KJ0052F01 and KJ0052F03, intersecting water conducting fractures are connected to the MICROBE laboratory via tubing. Each bore hole has been equipped with a circulation system offering a total of 500 cm<sup>2</sup> of test surface.

Retention of naturally occurring trace elements in the groundwater by the BIOS (Biological Iron Oxide Systems) is investigated at a site at tunnel length 2200A m. There is a vault with a

bore hole that delivers groundwater rich in ferrous iron and iron oxidising bacteria. The borehole is connected to two 200 x 30 x 20 cm artificial channels that mimic ditches in the tunnel. The channels have rock and artificial plastic support that stimulate BIOS formation.

At 907A m tunnel length, a small vault supports a ditch with groundwater that is rich in ferrous oxides and iron oxidising bacteria. This ditch is used as a natural analogue to the artificial BIOS channels at 2200 m.

A unique ecosystem of sulphur oxidising bacteria exists at tunnel length 1127B m, in the sulphur pond. Apart from being an intriguing site from a microbiological perspective, it also offers possibility to investigate microbial effects on the sulphur cycle in underground environments. It can be used to investigate microbial fractionation of sulphur isotopes and it will serve as an analogue for microbial influence on sulphur speciation in deep groundwater.

## **Achievements**

The laboratory container with an anaerobic gas box, and an advanced climate control system is in operation and the climate system function as expected. During this time period a campaign to measure dissolved gas in the groundwater in the MICROBE site has been carried out comprising a large number of analyses. The results from the measurements indicate a larger variation in the amounts of dissolved gas than expected, especially in the borehole (KJ0050F01) closest to the characterisation boreholes for the selection of site for the Äspö Pillar Experiment. It was therefore decided interrupt the activities at the MICROBE site until the excavations of new tunnels are completed and more stable conditions prevail in the rock.

The sulphur pond at 1128B-m tunnel length became completely dried out in January and a deeper pond was dug in February with the aim to stimulate the sulphur oxidising bacteria. This action seems to have been successful since the ecosystem slowly recovers.

The field experiment, to study the microbial corrosion of copper in bentonite with different densities at *in situ* conditions, which was started at the MICROBE 450 m site in December was concluded in February. The experiment was run at *in situ* pressure in groundwater with naturally occurring sulphate reducing bacteria (bore hole KJ0052F03). The analysis of the experiment is in progress and the results will be published.

## 4.6 Matrix Fluid Chemistry

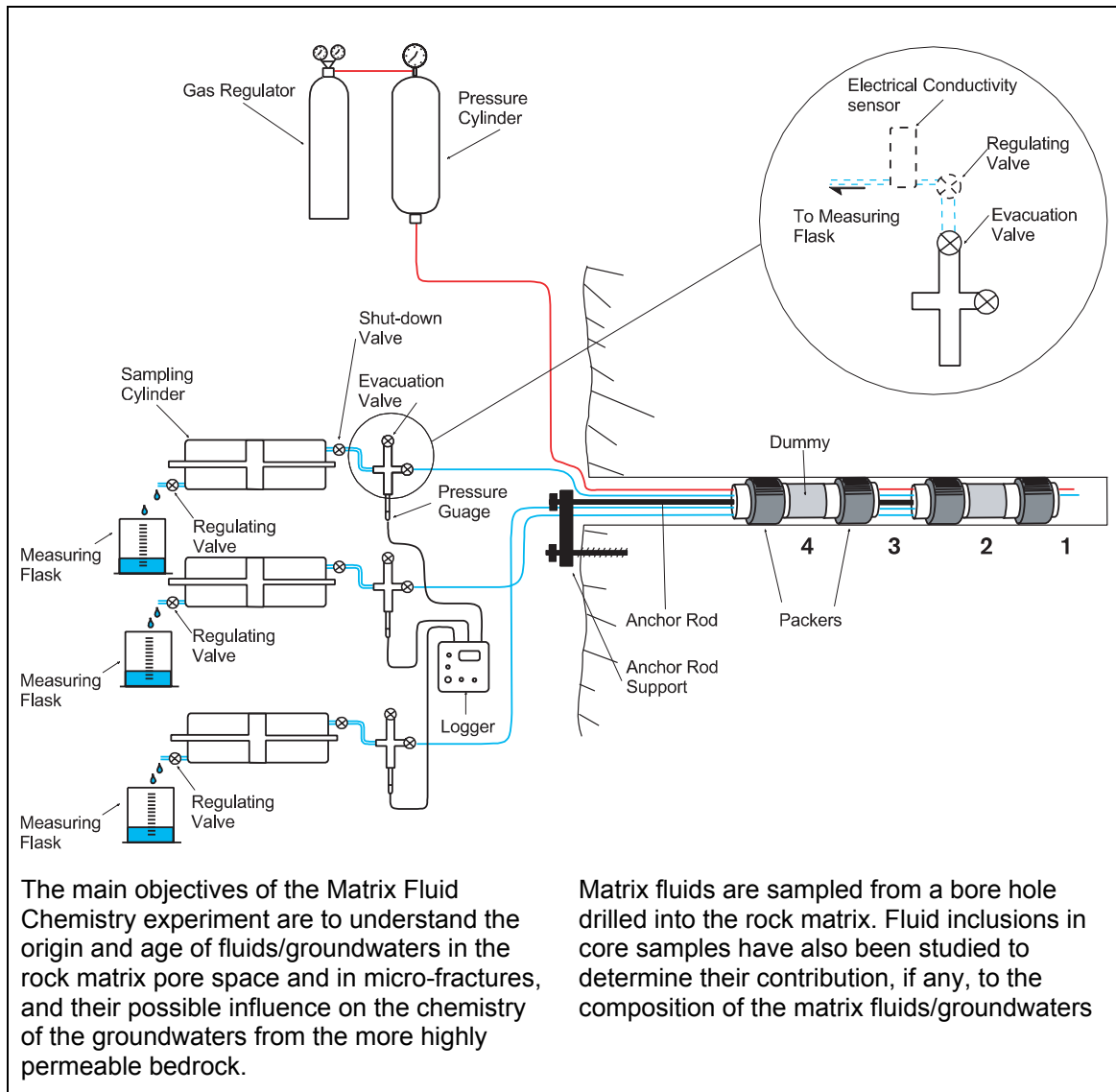

### **Achievements**

A final sampling of groundwater from the rock matrix borehole was performed in February. The analyses of the samples are in progress. The equipment is being adjusted as a preparation for a new sampling campaign, aimed at microfractures, which is planned for in April.

The completion of the reports for the first part of the project, including two major Synthesis Reports and a Final Report, is in progress. One Synthesis Report is in print and the two other reports will be printed in June. Reviewing of the Final Report should be completed at the end of the summer and ready for printing in the autumn. The second part project has commenced with the microfracture sampling indicated above and the project is scheduled to be completed in 2005.

## 4.7 Task Force on Modelling of Groundwater Flow and Transport of Solutes

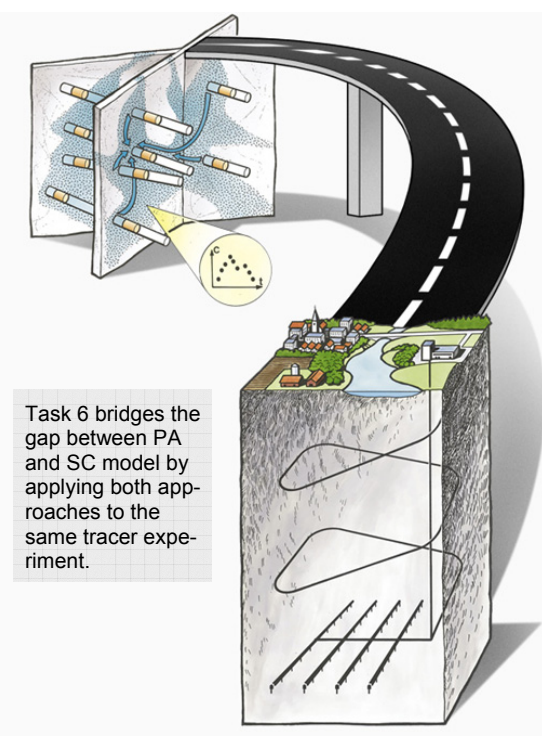

Task 6 bridges the gap between PA and SC model by applying both approaches to the same tracer experiment.

The Äspö Task Force on Modelling of Groundwater Flow and Transport of Solutes is a forum for the organisations supporting the Äspö HRL to interact in the area of conceptual and numerical modelling of groundwater flow and transport of solutes in fractured rock.

The Task Force shall propose, review, evaluate and contribute to the modelling work in the project. In addition, the Task Force shall interact with the principal investigators responsible for carrying out experimental and modelling works for Äspö HRL

The work within the Äspö Task Force constitutes an important part of the international co-operation within the Äspö Hard Rock Laboratory.

### **Achievements**

In the Task Force work activities have been in progress within the following tasks:

Task 5: Coupling between hydrochemistry and hydrogeology.

Task 6: Performance Assessment Modelling Using Site Characterisation Data.

The modelling exercises within *Task 5* have been completed and the ten modelling teams have prepared modelling reports and the entire work has been compiled and summarised in a summary report. All these reports are now printed and the task is concluded. Preliminary outcomes from the summary work and the evaluation of the task performed by external reviewers are presented in Morosini /2002/.

*Task 6* tries to bridge the gap between Performance Assessment (PA) and Site Characterisation (SC) models by applying both approaches for the same tracer experiment. It is hoped that this will help to identify the relevant conceptualisations (in processes/structures) for long-term PA predictions and identify site characterisation data requirements to support PA calculations. The status of the specific modelling tasks defined is given below in brackets:

Sub-task 6A Model and reproduce selected TRUE-1 tests with a PA model and/or a SC model to provide a common reference. (Finalised, reported, and external review in progress).

- Sub-task 6B Model selected PA cases at the TRUE-1 site with new PA relevant (long term/base case) boundary conditions and temporal scales. This task serves as means to understand the differences between the use of SC-type and PA-type models, and the influence of various assumptions made for PA calculations for extrapolation in time. (Finalised, reported, and external review in progress).
- Sub-task 6C Develop semi-synthetic, fractured granite hydrostructural models. Two scales are supported (200 m block scale and 2000 m site-scale). The models are developed based on data from the Prototype Repository, TRUE Block Scale, TRUE-1, and Fracture Characterisation and Classification project (FCC). (Finalised and reported /Dershowitz et al., 2003/).
- Sub-task 6D This sub-task is similar to sub-task 6A, and is using the semi-synthetic structural model (developed in Sub-task 6C) in addition to a 50 to 100 m scale TRUE-Block Scale tracer experiment. (In progress).
- Sub-task 6E This sub-task extends the sub-task 6D transport calculations to a reference set of PA time scales and boundary conditions. (Not initiated).



## 4.8 PADAMOT

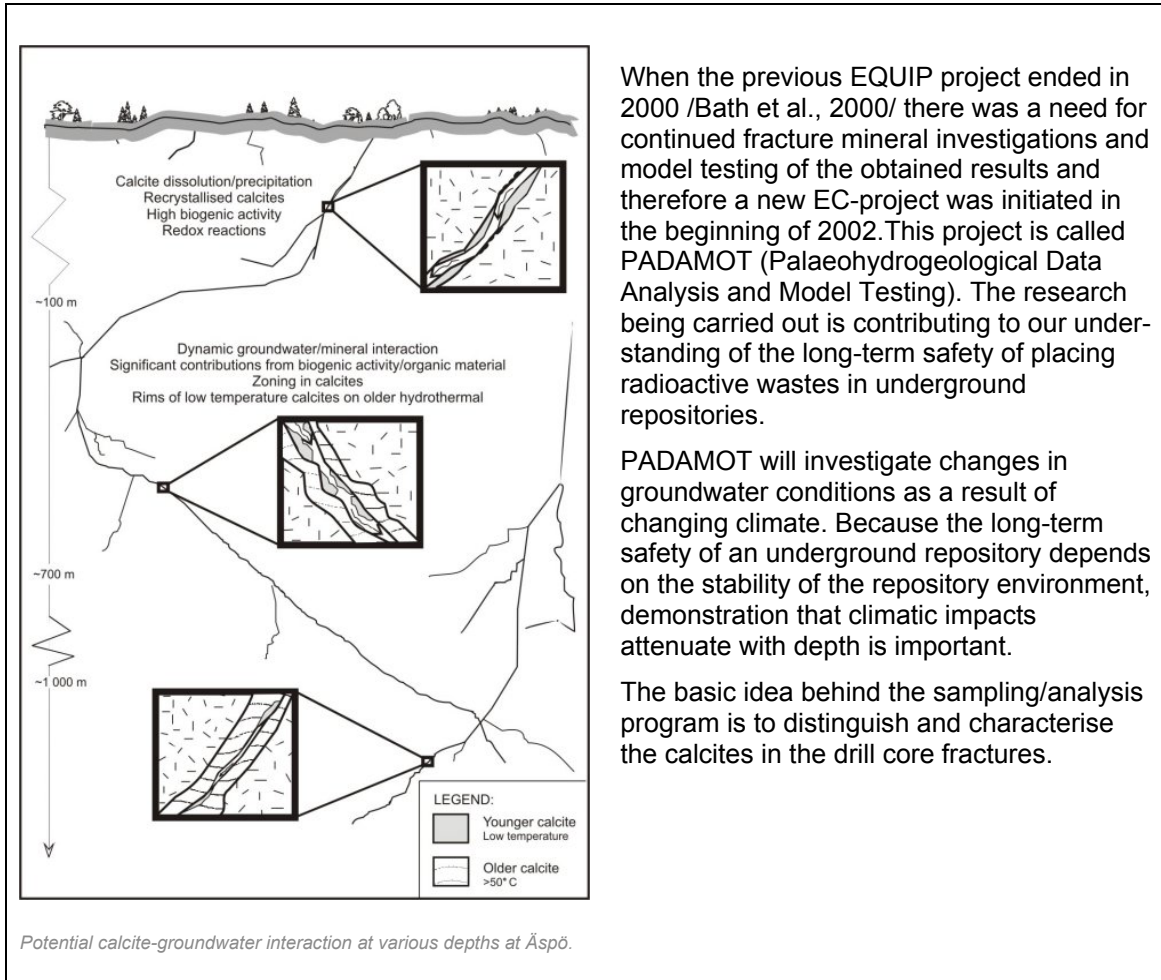

### **Achievements**

In March, a team was analysing the minerals in water-bearing fractures in drill cores from Laxemar (KLX01) with the aim to confirm earlier observed relations, from Sellafield, between water chemistry and calcite morphology. Calcite crystals developed in freshwater shows an equant structure (short C-axes), whereas crystals developed in saline water shows a scalenoedric structure.

The analysed drill cores from Laxemar had rather many fractures where the crystal morphology could be determined. The results were in good agreement with the earlier observed relations. The calcite crystal morphology in the surface fractures indicated the occurrence of meteoric water, which also a rather fractured section at 159 m did. The section in between indicated occurrence of saline water whereas the deep fractures (below 850 m) indicated that meteoric fresh water has reached this deep during some time period.

A number of samples have been selected that will be analysed with respect to chemical zones and fluid inclusions.

## 5 Äspö facility

An important part of the Äspö facility is the administration, operation, and maintenance of instruments as well as development of investigation methods. Other issues are to keep the stationary hydro monitoring system (HMS) continuously available and to carry out the programme for monitoring of groundwater head and flow and the programme for monitoring of groundwater chemistry.

### 5.1 Facility operation

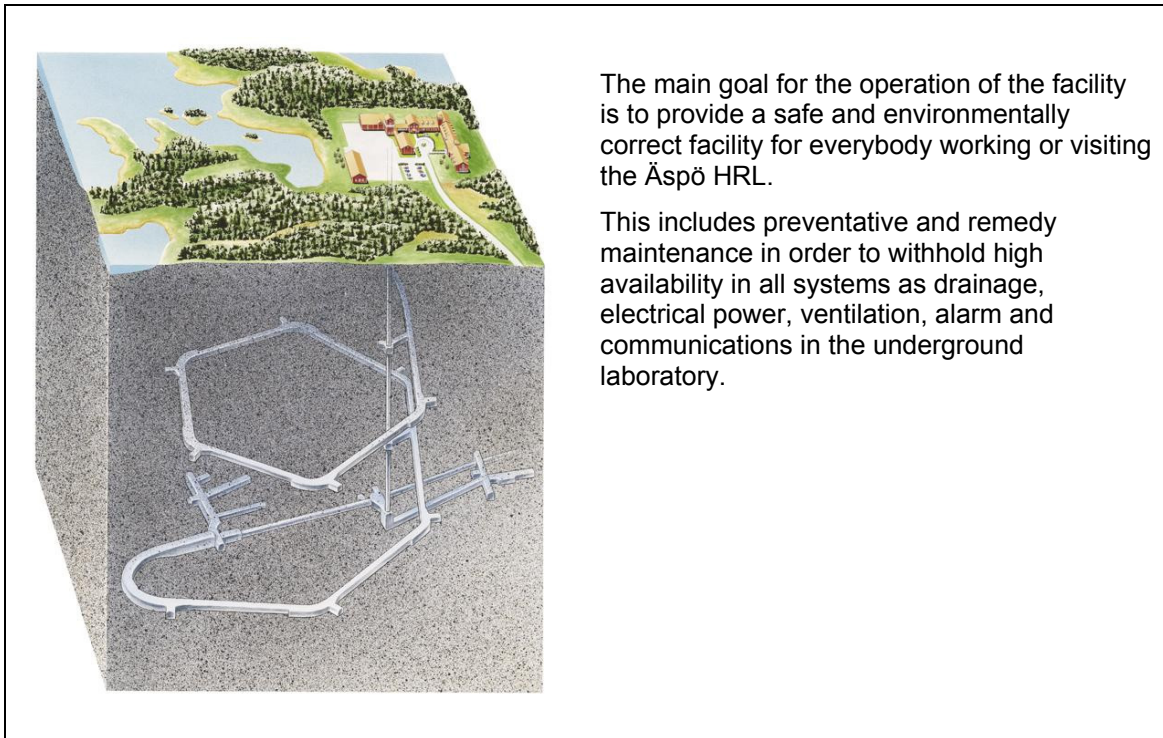

#### ***Achievements***

Maintenance and operation of the above and underground facilities are running as well as safety and work environment activities.

The extension of the office space in the Ventilation building is progressing and the work with the completion of the interior is close to be finalised.

### 5.2 Hydro Monitoring System

The Hydro Monitoring System (HMS) collects data on-line of groundwater head, salinity, electrical conductivity of the water in some borehole sections, and Eh and pH in some other bore holes. The data are recorded by more than 400 transducers installed in bore holes on Äspö as well as in bore holes located in the tunnel. Similar system will be set up at candidate sites for the deep repository. All data are transmitted to the main office at Äspö, by radio or modems. Weekly quality controls of preliminary ground-

water head data are performed. Absolute calibration of data is performed three to four times annually. This work involves comparison with groundwater levels checked manually in percussion drilled bore holes and in core drilled bore holes, in connection with the calibration work.

### ***Achievements***

The Hydro Monitoring System (HMS) has been performing well and no main maintenance activity has taken place.

## **5.3 Programme for monitoring of groundwater head and flow**

The monitoring of water levels started in 1987 while the computerised HMS was introduced in 1992. The number of bore holes included in the network has gradually increased. The tunnel excavation started in October 1990 and the first pressure measurements from tunnel drilled bore holes were included in the HMS in March 1992.

To date the monitoring network comprises bore holes of which many are equipped with hydraulically inflatable packers, measuring the pressure by means of transducers. The measured data are relayed to a central computer situated at Äspö village through cables and radio-wave transmitters. Once a year the data are transferred to SKB's site characterisation database, SICADA. Manual levelling is also obtained from the surface bore holes on a regular basis. Water seeping through the tunnel walls is diverted to trenches and further to 21 weirs where the flow is measured. The scope of maintaining such a monitoring network has scientific as well as legal grounds.

### ***Achievements***

The monitoring points from the previous year have been maintained and no additional points are planned during 2003. The system will continue to support the experiments undertaken and meet the requirements stipulated by the water rights court.

## **5.4 Programme for monitoring of groundwater chemistry**

During the Construction Phase of the Äspö HRL, different types of water samples were collected and analysed with the purpose of monitoring the groundwater chemistry and its evolution as the construction proceeded. At the beginning of the Operational Phase, sampling was replaced by a groundwater chemistry monitoring programme, aiming at a sufficient cover of the hydrochemical conditions with respect to time and space within the Äspö HRL. This programme is designed to provide information to determine where, within the rock mass, the hydrogeochemical changes are taking place in and at what time stationary conditions are established.

### ***Achievements***

The monitoring points from the previous year have been maintained.

## 6 International co-operation

Seven organisations from six countries (see list below) are participating in the co-operation at Äspö HRL during 2003. Most of the organisations are interested in ground-water flow, radionuclide transport and rock characterisation. All organisations are participating in the Äspö Task Force on Modelling of Groundwater Flow and Transport of Solutes, which is a forum for co-operation in the area of conceptual and numerical modelling of groundwater flow and solute transport in fractured rock.

### International participation in the Äspö HRL projects during 2003.

<b>Projects</b>	<b>ANDRA</b>	<b>BMWA</b>	<b>ENRESA</b>	<b>JNC</b>	<b>CRIEPI</b>	<b>NAGRA</b>	<b>Posiva</b>
<b>Technology</b>							
Prototype Repository (EC-project)	X	X	X	X	X		X
Backfill and Plug Test			X				
Long Term Test of Buffer Material							X
Low-pH cementitious products							X
KBS-3 method with horizontal emplacement							X
Large Scale Gas Injection Test							X
Temperature Buffer Test	X		X				
<b>Geo-science</b>							
Äspö Pillar Stability Experiment							X
<b>Natural barriers</b>							
Tracer Retention Understanding Experiments	X		X	X			X
Radionuclide Retention Project		X					
Colloid Project		X					X
Microbe Project		X					
Matrix Fluid Chemistry						X	
Task Force on Modelling of Groundwater Flow and Transport of Solutes	X		X	X	X	X	X

**Participating organisations:**

Agence Nationale pour la Gestion des Déchets Radioactifs, ANDRA, France.

Bundesministerium für Wirtschaft und Arbeit, BMWA, Germany

Empresa Nacional de Residuos Radiactivos, ENRESA, Spain

The Central Research Institute of the Electronic Power Industry, CRIEPI, Japan

Japan Nuclear Cycle Development Institute, JNC, Japan.

Nationale Genossenschaft für die Lagerung Radioaktiver Abfälle, NAGRA, Switzerland

Posiva, Finland.

***EC-projects***

SKB is through Repository Technology co-ordinating three EC-contracts: Prototype Repository, Cluster Repository Project (CROP) and the project NET.EXCEL. SKB takes part in several EC-projects of which the representation is channelled through Repository Technology in five cases: FEBEX II, BENCHPAR, ECOCLAY II, SAFETI and PADAMOT.

**Prototype Repository** – Full scale testing of the KBS-3 concept for high-level radioactive waste (2000-09-01 – 2004-02-29)

Co-ordinator: Swedish Nuclear Fuel and Waste Management Co, Sweden

Participating countries: Finland, Germany, Japan, Spain, Sweden and United Kingdom

**CROP** – Cluster repository project, a basis for evaluating and developing concepts of final repositories for high level radioactive waste (2001-02-01 – 2004-01-31)

Co-ordinator: Swedish Nuclear Fuel and Waste Management Co, Sweden

Participating countries: Belgium, Canada, Finland, France, Germany, Spain, Sweden, Switzerland and USA

**FEBEX II** – Full-scale engineered barriers experiment in crystalline host rock phase II (1999-07-01 – 2003-12-31)

Co-ordinator: Empresa Nacional de Residuos Radiactivos, Spain

Participating countries: Belgium, Czech Republic, Finland, France, Germany, Spain, Sweden, and Switzerland

**BENCHPAR** – Benchmark tests and guidance on coupled processes for performance assessment of nuclear repositories (2000-10-01 – 2003-09-30)

Co-ordinator: Royal Institute of Technology (Dep. of Civil and Environmental Engineering), Sweden

Participating countries: Finland, France, Spain, Sweden and United Kingdom

**ECOCLAY II** – Effects of cement on clay barrier performance, phase II (2000-10-01 – 2003-09-30)

Co-ordinator: National Radioactive Waste Management Agency of France

Participating countries: Belgium, Finland, France, Germany, Spain, Sweden, Switzerland and United Kingdom

**SAFETI** – Seismic validation of 3-D thermo-mechanical models for the prediction of the rock damage around radioactive spent fuel waste (2001-09-01 – 2004-09-01)

Co-ordinator: The University of Liverpool (Dep of Earth Sciences), United Kingdom

Participating countries: France, Sweden and United Kingdom

**PADAMOT** – Paleohydrogeological data analysis and model testing (2001-11-01 – 2004-11-01)

Co-ordinator: Nirex Ltd, United Kingdom

Participating countries: Czech Republic, Spain, Sweden and United Kingdom

**NET.EXCEL** – Network of excellence in nuclear waste management and disposal (2002-11-01–2004-01-31)

Co-ordinator: Swedish Nuclear Fuel and Waste Management Co, Sweden

Participating countries: Belgium, Finland, France, Germany, Spain, Sweden, Switzerland, and United Kingdom

## 7 Documentation

During the period January–March 2003, the following reports have been published and distributed.

### 7.1 Äspö International Progress Reports

**Nyberg G, Jönsson S, Wass E, 2002.** Hydro monitoring program. Report for 2001. IPR-02-56. Svensk Kärnbränslehantering AB.

**Goudarzi R, Börgesson L, 2002.** Sensors data report (Period: 010917-020901) Prototype Repository Report No:3. IPR-02-61. Svensk Kärnbränslehantering AB.

**Thorsager, P, 2002.** Temperature Buffer test. Detailed design materials. Foundation and artificial saturation. IPR-02-62. Svensk Kärnbränslehantering AB.

**Sundberg J, Ländell M, 2002.** Determination of linear thermal expansion. Samples from borehole KA2599G01. Äspö HRL. IPR-02-63. Svensk Kärnbränslehantering AB.

**Äspö Hard Rock Laboratory.** Status Report January-June 2002. IPR-02-65. Svensk Kärnbränslehantering AB.

**Larsson K, 2001.** Determination of the coefficient of thermal expansion for two Äspö rocks, Diorite and Granite Äspö HRL. IPR-02-66. Svensk Kärnbränslehantering AB.

**Goto J, 2002.** Geological study on block scale water-conducting structures representative in the tunnel. IPR-02-67. Svensk Kärnbränslehantering AB.

**Pöllänen J, Rouhiainen P, 2003.** Difference flow measurements in borehole KA3376B01 at the Äspö HRL. IPR-03-07. Svensk Kärnbränslehantering AB.

**Goudarzi R, Börgesson L, Röshoff K, Bono N, 2002.** Canister retrieval test. Sensors data report (Period 001026-021101) Report nr: 5. IPR-03-08. Svensk Kärnbränslehantering AB.

**Äspö Hard Rock Laboratory.** Status Report July-September 2002. IPR-03-09. Svensk Kärnbränslehantering AB.

**Bath A H, Jackson C P, 2002.** Task Force modelling of groundwater flow and transport of solutes. Review of Task 5. IPR-03-10. Svensk Kärnbränslehantering AB.

**Goudarzi R, Börgesson L, 2002.** Sensors data report (Period: 010917-021201)  
Prototyp Repository. Report No:4.  
IPR-03-15 . Svensk Kärnbränslehantering AB.

## **7.2 Technical Documents and International Technical Documents**

4 Technical Documents

1 International Technical Document



## 8 References

- Andersson C, 2003.** Äspö Pillar Stability Experiment. Feasibility Study. IPR-03-01. Svensk Kärnbränslehantering AB.
- Andersson P, Byegård J, Dershowitz B, Doe T, Hermansson J, Meier P, Tullborg E-L, Winberg A (ed), 2002a.** Final report of the TRUE Block Scale project. 1. Characterisation and model development. TR-02-13. Svensk Kärnbränslehantering AB.
- Andersson P, Byegård J, Winberg A, 2002b.** Final report of the TRUE Block Scale project. 2. Tracer tests in the block scale. TR-02-14. Svensk Kärnbränslehantering AB.
- Bath A, Milodowski, A, Ruotsalainen P, Tullborg E-L, Cortés Ruiz A, Aranyossy J-F, 2000.** Evidence from Mineralogy and Geochemistry for the Evolution of Groundwater Systems During the Quaternary for Use In Radioactive Waste Repository Assessment (EQUIP Project). Final Report, Contract No FI4W-CT96-0031. Euratom/EC-DG-Research, Report EUR 19613EN. 157 pp. European Commission, Luxembourg.
- Byegård J, 2002b.** Some method developments, preliminary measurements, and laboratory experiments. IPR-02-68, Svensk Kärnbränslehantering AB.
- Dershowits W, Winberg A, Hermanson J, Byegård J, Tullborg E-L, Andersson P, Mazurek M, 2003.** Äspö Hard Rock Laboratory. Äspö Task Force on modelling of groundwater flow and transport of solutes. Task 6c. A semi-synthetic model of block scale conductive structures at the Äspö HRL. IPR-03-13. Svensk Kärnbränslehantering AB.
- Fransson Å, 2003.** Äspö Pillar Stability Experiment. Core boreholes KF0066A01, KF0069A01, KA3386A01 and KA3376B01: Hydrogeological characterization and pressure responses during drilling and testing. IPR-03-06. Svensk Kärnbränslehantering AB.
- Fredriksson A, Staub I, Janson T, 2003.** Äspö Pillar Stability Experiment. Design of heaters and preliminary results from coupled 2D thermo-mechanical modelling. IPR-03-03. Svensk Kärnbränslehantering AB.
- Morosini M, 2002.** Äspö Task Force on modelling of groundwater flow and transport of solutes. Proceedings from the 15th Task Force meeting at Goslar, Germany, September 11-13, 2001. IPR-02-07. Svensk Kärnbränslehantering AB.
- Poteri A, Billaux D, Dershowitz W, Gómez-Hernández J J, Cvetkovic V, Hautojärvi A, Holton D, Medina A, Winberg A (ed), 2002.** Final report of the TRUE Block Scale projekt. 3. Modelling of flow and transport. TR-02-15. Svensk Kärnbränslehantering AB.

**SKB, 2001a.** RD&D-Programme 2001. Programme for research, development and demonstration of methods for the management and disposal of nuclear waste. TR-01-30. Svensk Kärnbränslehantering AB.

**SKB, 2001b.** Forsknings-, utvecklings- och demonstrationsprogram för ett KBS-3-förvar med horisontell deponering. R-01-55. Svensk Kärnbränslehantering AB.

**SKB, 2003.** Äspö Hard Rock Laboratory. Planning Report for 2002. IPR-03-24. Svensk Kärnbränslehantering AB.

**Staub I, Janson T, Fredriksson A, 2003.** Äspö Pillar Stability Experiment. Geology and properties of the rock mass around the experiment volume. IPR-03-02. Svensk Kärnbränslehantering AB.

**Sundberg J, 2003a.** Thermal Site Descriptive Model. A strategy for the model development during site investigations. Version 1.0. R-03-10. Svensk Kärnbränslehantering AB.

**Sundberg J, 2003b.** Thermal properties at Äspö HRL. Analysis of distribution and scale factors. R-03-17. Svensk Kärnbränslehantering AB.

**Rinne M, Baotang S, Hee-Suk L, 2003.** Äspö Pillar Stability Experiment. Modelling of fracture stability by Fracod. Preliminary results. IPR-03-05. Svensk Kärnbränslehantering AB.

**Römer J, Kienzler B, Vejmelka P, Soballa E, Görtzen A, Fuss M, 2002.** Actinide Migration experiment in the HRL Äspö, Sweden: Results of laboratory and *in situ* experiments (Part II). WB-FZKA 6770, October 2002, FZK-INE, Karlsruhe, Germany.

**Winberg A, Andersson P, Byegård J, Poteri A, Cvetkovic V, Dershowitz W, Doe T, Hermanson J, Gomez-Hernandez J J, Hautjärvi A, Billaux D, Tullborg E-L, Holton D, Meier P, Medina A, (in print).** Final report of the TRUE Block Scale project. 4. Synthesis of flow, transport and retention in the block scale TR-02-16. Svensk Kärnbränslehantering AB.

**Wanne T, Johansson E, 2003.** Äspö Pillar Stability Experiment. Coupled 3D thermo-mechanical modelling. Preliminary results. IPR-03-04. Svensk Kärnbränslehantering AB.