

Technical Report

TR-09-10

Äspö Hard Rock Laboratory

Annual report 2008

Svensk Kärnbränslehantering AB

July 2009

Svensk Kärnbränslehantering AB

Swedish Nuclear Fuel
and Waste Management Co

Box 250, SE-101 24 Stockholm
Phone +46 8 459 84 00



Äspö Hard Rock Laboratory

Annual report 2008

Svensk Kärnbränslehantering AB

July 2009

Abstract

The Äspö Hard Rock Laboratory (HRL) is an important part of SKB's work with the design and construction of a deep geological repository for the final disposal of spent nuclear fuel. Äspö HRL is located in the Simpevarp area in the municipality of Oskarshamn. One of the fundamental reasons behind SKB's decision to construct an underground laboratory was to create opportunities for research, development and demonstration in a realistic and undisturbed rock environment down to repository depth. The underground part of the laboratory consists of a tunnel from the Simpevarp peninsula to the southern part of Äspö where the tunnel continues in a spiral down to a depth of 460 m. Äspö HRL has been in operation since 1995 and considerable international interest has been shown in its research, as well as in the development and demonstration tasks. A summary of the work performed at Äspö HRL during 2008 is given below.

Geoscience

Geoscientific research is a basic activity at Äspö HRL. The aim of the current studies is to develop geoscientific models of the Äspö HRL and increase the understanding of the rock mass properties as well as knowledge of applicable methods of measurement. A main task within the geoscientific field is the development of the Äspö Site Descriptive Model (SDM) integrating information from the different fields. The main activities in the geoscientific fields have been: (1) Geology – completion of the feasibility study concerning geological mapping techniques and mapping of rock surfaces in the new tunnel, (2) Hydrogeology – monitoring and storage of data in the computerised Hydro Monitoring System, (3) Geochemistry – sampling of groundwater in the yearly campaign and for specific experiments and (4) Rock Mechanics – field tests to evaluate the counterforce needed to prevent thermally-induced spalling in deposition holes.

Natural barriers

At Äspö HRL, experiments are performed under the conditions that are expected to prevail at repository depth. The experiments are related to the rock, its properties and in situ environmental conditions. The aim is to provide information about the long-term function of natural and repository barriers. Experiments are performed to develop and test methods and models for the description of groundwater flow, radionuclide migration, and chemical conditions at repository depth. The programme includes projects which aim to determine parameter values that are required as input to the conceptual and numerical models.

A programme has been defined for tracer tests at different experimental scales, the so-called *Tracer Retention Understanding Experiments* (True). The overall objectives of the experiments are to gain a better understanding of the processes which govern the retention of radionuclides transported in crystalline rock and to increase the credibility of models used for radionuclide transport calculations. During 2008, work has been performed in the projects: *True Block Scale Continuation* and *True-1 Continuation* (writing of papers to scientific journals) and *True-1 Completion* (meeting to plan the coming analyses of material from the over-coring of two boreholes at the True-1 site performed in 2007).

The *Long Term Sorption Diffusion Experiment* complements the diffusion and sorption experiments performed in the laboratory, and is a natural extension of the True-experiments. The in situ sorption diffusion experiment was started in September 2006 and after injection of epoxy resin the over-coring was successful in the beginning of May 2007. To allow determination of sorption and penetration profiles of the different tracers used in the experiment several sample preparation methods and analysis techniques have been necessary to adopt. During 2008 analyses were performed on sample cores drilled from the fracture surface on the core stub and from the matrix rock surrounding the test section.

The *Colloid Transport Project* was initiated in 2008 and is a continuation of earlier colloid projects. The overall goal for the project is to answer the questions when colloid transport has to be taken into account in safety assessments. The project comprises field tests at the Grimsel test site in

Switzerland and laboratory experiments to study colloid stability and mobility under different conditions. Modelling of colloid transport experiments in fractures with different length, filling and aperture was performed.

Microorganisms interact with their surroundings and in some cases they greatly modify the characteristics of their environment. Several such interactions may have a significant influence on the function of a future repository for spent fuel, and are therefore studied in the *Microbe Projects*. In the microbe laboratory, located at the –450 m level in Äspö HRL, studies of microbial processes are on-going within several projects. Bio-mobilisation and bio-immobilisation of radionuclides are studied in *Micomig*, microbial effects on the chemical stability of deep groundwater environments in *Micored* and bio-corrosion in *Biocor*.

The project *Matrix Fluid Chemistry Continuation* focuses on the small-scale micro-fractures in the rock matrix which facilitate the migration of matrix waters. Understanding of the migration of groundwater, and its changing chemistry, is important for repository performance. Data from hydraulic testing of fracture-free and fracture-containing borehole sections in the matrix borehole are available. Reporting of analyses of matrix pore water chemistry and the matrix borehole hydraulic studies is ongoing.

The continuation of the project *Padamot* includes developments of analytical techniques for uranium series analyses applied on fracture mineral samples and focuses on the use of these analyses for determination of the redox conditions during glacial and postglacial time. Two laboratories have carried out uranium series analyses on samples taken from a drill core at Äspö. The results so far are very promising in that the samples seem to mirror the redox front, both mobilisation and deposition of uranium are shown.

The basic idea behind the project *Fe-oxides in Fractures* is to examine Fe-oxide fracture linings, in order to explore suitable palaeo-indicators and their formation conditions. During 2008 the continuation phase of the project entitled: 'To establish the penetration depth of oxidising waters below ground surface' has been finalised. A new analytical method to determine the penetration depth of oxidising waters using Fe-oxides has been used in the analyses of a drillcore from Laxemar. The results suggest that fractures of the upper 50 meters are currently experiencing episodes of oxidising conditions and that oxidising waters can penetrate down to a depth of approximately 90 meters without glacial influence.

The *Single Well Injection Withdrawal (Swiw) Test with Synthetic Groundwater* constitutes a complement to the tests and studies performed on the processes governing retention of radionuclides in the rock, e.g. the True experiments. The feasibility study has been finalised and the True Block Scale Site is one of three candidate sites. The original plan for 2008 was to decide a test site for the project, but since the ongoing work at the new tunnel in the vicinity blocks the site until June 2009 the selection of a test site has been postponed.

Important goals of the activities at Äspö HRL are the evaluation of the usefulness and reliability of different models and the development and testing of methods to determine parameter values required as input to the models. An important part of this work is performed in the *Task Force on Modelling of Groundwater Flow and Transport of Solutes*. Task 6 (performance assessment modelling using site characterisation data) initiated in 2001 has now been completed and modelling work is ongoing in Task 7 (long-term pumping test in Olkiluoto, Finland). Task 7 is also addressing the usage of Posiva Flow Log (PFL) data and issues related to open boreholes.

Engineered barriers

At Äspö HRL, an important goal is to demonstrate technology for and the function of important parts of the repository system. This implies translation of current scientific knowledge and state-of-the-art technology into engineering practice applicable in an operational repository. It is important that development, testing and demonstration of methods and procedures are conducted under realistic conditions and at an appropriate scale. A number of large-scale field experiments and supporting activities are therefore carried out at Äspö HRL. The experiments focus on different aspects of engineering technology and performance testing.

The *Prototype Repository* is a demonstration of the integrated function of the repository and provides a full-scale reference for tests of predictive models concerning individual components as well as the complete repository system. The layout involves altogether six deposition holes, four in an inner section and two in an outer. The relative humidity, pore pressure, total pressure and temperature in different parts of the test area are monitored. Although the tunnel is drained, the pore pressure in the backfill in both sections is continuing to increase. During 2008, the work with the new tunnel near by the site has affected both the measured pressure and the water outflow from the tunnel.

The *Long Term Test of Buffer Material (Lot-experiment)* aims at validating models and hypotheses concerning physical properties in a bentonite buffer material and of related processes regarding microbiology, radionuclide transport, copper corrosion and gas transport under conditions similar to those in a KBS-3 repository. Further analyses of the long-term test parcel (A2) have been made at different laboratories and the three remaining test parcels have been functioning without any disturbances during 2008.

The objective of the project *Alternative Buffer Materials* is to study clay materials that in laboratory tests have shown to be conceivable buffer materials. Three test parcels with different combinations of clay materials are installed in boreholes at Äspö HRL. The parcels are heated carefully to increase the temperature in the buffer to 130°C. The heaters in two parcels were activated initially and the goal value was reached in the end of 2007. In the third parcel the buffer was fully saturated in August 2008 and the heaters were activated. In addition, analyses of different buffer materials have been performed.

The *Backfill and Plug Test* is a test of the hydraulic and mechanical function of different backfill materials, emplacement methods and a full-scale plug. The inner part of the drift is backfilled with a mixture of bentonite and crushed rock and the outer part is filled with crushed rock. The wetting of the backfill started at the end of 1999 and the backfill was completely water saturated in 2003. Since then testing of flow to measure the hydraulic conductivity in different parts of the backfill and compressibility tests have been performed. Ongoing monitoring comprises measurements of water pressure, total pressure and leakage of water through the plug in the tunnel.

The aim of the *Canister Retrieval Test* was to demonstrate readiness for recovering emplaced canisters even after the time when the surrounding bentonite buffer is fully saturated. The canister was successfully retrieved in 2006. The saturation phase had, at that time, been running for more than five years with continuous measurements of the wetting process, temperature, stresses and strains. During 2008, analyses of the retrieved buffer have progressed and are close to being finalised. The laboratory work has produced data of the mechanical strength, the swelling pressure, hydraulic conductivity and the chemical/mineralogical constitution.

The *Temperature Buffer Test* aims at improving our current understanding of the thermo-hydro-mechanical behaviour of buffers with a temperature around and above 100°C during the water saturation transient. The experiment has generated data since the start in 2003 and the temperature in the buffer around the lower heater had, in the end of 2008, reached a value of 150°C. The evaluation of THM processes is made through analyses of sensors data and numerical modelling. In parallel, evaluation and numerical modelling are made of lab-scale mock-up tests performed by CEA in France. The previously planned gas injection test in the upper buffer will not be carried out since hydraulic tests revealed that the buffer around the sand-shield was not sufficiently tight.

SKB and Posiva are co-operating on a programme for the *KBS-3 Method with Horizontal Emplacement* (KBS-3H). A continuation phase of the project is ongoing and the aim of the complementary studies is to develop KBS-3H to such a level that the decision of full scale testing can be made. During 2008 several tests have been performed at the -220 m level in Äspö HRL. The tests with the Megapacker, a grouting device, have been successful and the tests with the deposition equipment look very promising, however, improvements have to be made to make it more robust. In addition, preparations have been made for construction and testing of a compartment plug (steel plug).

The aim of the *Large Scale Gas Injection Test* is to perform gas injection tests in a full-scale KBS-3 deposition hole. The installation phase, including the deposition of canister and buffer, was finalised in 2005. Water is artificially supplied and the evolution of the saturation of the buffer is continuously monitored. The preliminary hydraulic and gas injection tests were completed in the first quarter of

2008. Analysis of the hydraulic data indicates only minor or no changes of the buffer properties after the gas injection tests. In 2009 a second series of preliminary gas injection tests will be made as part of the ongoing hydration phase. A concerted effort has also been made for the quality assurance of experimental data during 2008.

Although a repository will be located in rock mass of good quality with mostly relatively low fracturing, sealing by means of rock grouting will be necessary. The main goal of the project *Sealing of Tunnel at Great Depth* is to confirm that silica sol is a useful grout at the water pressures prevailing at repository level. To achieve this, the Tass-tunnel has been constructed at the -450 m level at Äspö HRL. The excavation of the Tass-tunnel started at the end of 2007 and has now reached its final length of 80 meters. Grouting has been performed with ordinary grouting fans outside the tunnel contour and with holes drilled inside the contour. In the project it has been shown that it is possible to limit the inflow to a deposition tunnel to the required value with injection of silica sol both in fans outside and inside the tunnel contour.

The objective of the project *In situ Corrosion Testing of Miniature Canisters* is to obtain a better understanding of the corrosion processes inside a failed canister. In Äspö HRL in situ experiments are performed with miniature copper canisters with cast iron inserts. The canisters will be exposed to both natural reducing groundwater and groundwater which has been conditioned by bentonite. In the beginning of 2007 all five canisters were installed in the boreholes and a report on the installation and results obtained until May 2008 has been prepared. The monitoring has continued and data relating to the chemical conditions, corrosion of the test specimens and dimensional changes are continuously collected and analysed.

In the project *Cleaning and Sealing of Investigation Boreholes* the best available techniques are to be identified and demonstrated. In order to obtain data on the properties of the rock, boreholes are drilled during site investigations. These investigation boreholes must be cleaned and sealed, no later than at the closure of the repository. The work performed in 2008 has mainly included the characterisation of a number of investigation boreholes at Laxemar and Forsmark. The aim has been to select two boreholes that are representative and can be used as reference holes for further studies in the project.

The *Task Force on Engineered Barrier Systems* addresses, in the first phase, two tasks: (1) THM processes and (2) gas migration in buffer material. However, at the end of 2006 it was decided to start a parallel Task Force that deals with geochemical processes in engineered barriers. During 2008, two Task Force meetings have been held. In Benchmark 1 (laboratory tests) the modelling of THM processes and gas breakthrough is finalised. In Benchmark 2 (large scale field tests) the main work has been within modelling of the Canister retrieval test at Äspö HRL and the finalising of the modelling of the URL tests. Laboratory experiments and results from the experiment Long term test of buffer materials have been used as benchmarks for the performed geochemical modelling. The chemistry group has had two meetings where it was discussed how to adjust existing general geochemical modelling tools in order to successfully apply them to bentonite modelling.

Äspö facility

The Äspö facility comprises both the Äspö Hard Rock Laboratory and the Bentonite Laboratory. Important tasks of the Äspö facility are the administration, operation, and maintenance of instruments as well as development of investigation methods. The main goal of the operation of the facility is to provide a safe and environmentally sound facility for everybody working or visiting the Äspö HRL. The goal of an operational time of 98% for the underground laboratory was as earlier years exceeded. The Bentonite Laboratory has been in full operation during 2008, where different methods and techniques for installation of pellets and blocks in deposition tunnels and tests on piping and erosion of buffer and backfill material have been performed. The public relations and visitor services group is responsible for presenting information about SKB and its facilities. During the year 2008 SKB facilities and the site investigation activities in Oskarshamn and Forsmark were visited by about 24,000 visitors.

Environmental research

Äspö Environmental Research Foundation was founded in 1996 on the initiative of local and regional interested parties. The aim was to make the underground laboratory at Äspö and its resources available for national and international environmental research. The activities have since 2003 been concentrated to the Äspö Research School. When the school's activities were concluded as planned in 2008, the remaining and new research activities were transferred within the frame of a new co-operation, Nova Research and Development (Nova FoU). The aim is to support new and innovative research, where the extensive SKB data set from geological, hydrogeological, hydrogeochemical and ecological investigations can be used.

International co-operation

In addition to SKB, eight organisations from seven countries participated in the international co-operation at Äspö HRL during 2008. Six of them: Andra, BMWi, CRIEPI, JAEA, NWMO and Posiva together with SKB form the Äspö International Joint Committee which is responsible for the co-ordination of the experimental work arising from the international participation. The international organisations are participating in the experimental work at Äspö HRL as well as in the two Äspö Task Forces: (1) Task Force on Modelling of Groundwater Flow and Transport of Solutes and (2) Task Force on Engineered Barrier Systems.

Sammanfattning

Äspölaboratoriet i Simpevarp i Oskarshamns kommun är en viktig del i SKB:s arbete med utformning, byggande (och drift) av ett slutförvar för använt kärnbränsle. Ett av de grundläggande skälen till SKB:s beslut att anlägga ett underjordslaboratorium var att skapa förutsättningar för forskning, utveckling och demonstration i en realistisk och ostörd bergmiljö på försvarsdjup. Underjordslaboratoriet utgörs av en tunnel från Simpevarpshalvön till södra delen av Äspö där tunneln fortsätter i en spiral ner till 460 meters djup. Äspölaboratoriet har varit i drift sedan 1995 och verksamheten har väckt stort internationellt intresse. Här följer en sammanfattning av det arbete som bedrivits vid Äspölaboratoriet under 2008.

Geovetenskap

Forskning inom geovetenskap är en grundläggande del av arbetet vid Äspölaboratoriet. Det huvudsakliga målet med de pågående studierna är att utveckla geovetenskapliga modeller samt att öka förståelsen för bergmassans egenskaper och kunskapen om användbara mätmetoder. Den huvudsakliga uppgiften inom det geovetenskapliga området är utvecklingen av en platsbeskrivande modell för Äspö där information från olika ämnesområden integreras. De huvudsakliga aktiviteterna inom de olika områdena har varit: (1) Geologi – avslutat förstudien av geologiska karteringsmetoder och utfört kartering av bergytor i den nya tunneln, (2) Hydrogeologi – övervakning och lagring av data i det datoriserade hydromonitoringssystemet, (3) Geokemi – den årliga provtagningen av grundvatten samt provtagning för specifika experiment och (4) Bergmekanik – fältförsök för att utvärdera vilket mottryck som behövs för att förhindra termiskt inducerad spjälkning i deponeringshål.

Naturliga barriärer

I Äspölaboratoriet genomförs experimenten vid förhållanden som liknar de som förväntas råda på försvarsdjup. Experimenten kopplar till berget, dess egenskaper och in situ förhållanden. Målet med de pågående experimenten är att ge information om hur de naturliga och tekniska barriärerna fungerar i ett långtidsperspektiv. Ett viktigt syfte med verksamheten vid Äspölaboratoriet är att vidareutveckla och testa beräkningsmodeller för grundvattenströmning, radionuklidtransport och kemiska processer på försvarsnivå. I programmet ingår att bestämma värden på de parametrar som krävs som indata till konceptuella och numeriska modeller.

Bergets förmåga att fördröja transport av spårämnen studeras i olika skalor i *True-försöken*. Syftet är att öka förståelsen för de processer som styr fördröjningen av radionuklider i kristallint berg samt att öka tillförlitligheten hos de modeller som används för beräkning av radionuklidtransport. Under 2008 har arbete skett inom delprojekten: "*True Block Scale Continuation*" och "*True-1 Continuation*" (framtagning av artiklar för publicering i vetenskapliga tidskrifter) och "*True-1 Completion*" (möte för att planera de kommande analyserna av material från överborrningen av två borrhål vid True-1 som genomfördes under 2007).

LTDE-försöket är ett komplement till de sorptions- och diffusionsförsök som genomförts i laboratoriet och är också en utvidgning av de experiment som genomförts inom True-programmet. Sorptions- och diffusionsförsöket in situ startade i september 2006 och efter injicering av epoxi slutfördes överborrningen med lyckat resultat i början av maj 2007. För att kunna bestämma sorption och penetrationsprofiler för de olika spårämnen som användes i försöket har både provberedning och analysmetoder behövt anpassas. Analyser har under 2008 gjorts på provkärnor som borrats från sprickytan på borrhållan och från den omkringliggande bergmatrisen.

Kolloidtransportprojektet initierades under 2008 och är en fortsättning på tidigare genomförda kolloidprojekt. Målsättningen med projektet är att ge svar på frågor som rör hur kolloidtransport bör behandlas i kommande säkerhetsanalyser. I projektet ingår fältexperiment i Grimsellaboratoriet i Schweiz och laboratorieexperiment för att studera kolloiders stabilitet och rörlighet under olika förhållanden. Transportmodellering görs på genomförda experiment i sprickor med olika längd, fyllnadsmaterial och sprickvidd.

Mikroorganismer samverkar med sin omgivning och kan i vissa fall ha en betydande inverkan på förhållandena där. Detta kan vara av betydelse för hur ett framtida förvar för använt bränsle fungerar och studeras därför inom *Mikroprojektet*. I mikrolaboratoriet på 450 m djup i Äspö pågår studier av mikrobiella processer inom flera projekt. Mikrobers förmåga att mobilisera och binda radionuklider studeras i projektet *Micomig*, mikrobiella effekter på den kemiska stabiliteten i miljöer med djupt grundvatten studeras i *Micored* och bio-korrosion studeras i *Biocor*.

I fortsättningen av *Matrisförsöket* är fokus på hur de småskaliga mikrosprickorna i bergmatrisen underlättar matrisporvattnets rörelse. Förståelsen av grundvattnets rörelse och förändringar i vattenkemin är viktig för slutförvarets funktion. Data från de hydrauliska testerna av sprickfria och uppspruckna sektioner i matrisborrhålet finns tillgängliga. Rapportering av genomförda kemiska analyser på matrisporvatten och hydrauliska tester i matrisborrhålet pågår.

I fortsättningsprojektet av *Padamot* ingår utveckling av analytiska tekniker för uranserieanalyser på mineralprov i sprickor med fokus på användningen av dessa analyser för bestämningen av redoxförhållanden under glaciala och postglaciala förhållanden. Uranserieanalyser har genomförts av två laboratorier på prov tagna från en borrhärlinje från Äspö. Erhållna resultat verkar lovande i det avseende att proven återspeglar redoxfronten, både mobilisering och fastläggning av uran syns.

I projektet *Järnoxider i sprickor* undersöks järnoxidtäkta sprickytor för att hitta lämpliga palaeo-indikatorer och beskriva under vilka förhållanden dessa bildas. Under 2008 har fortsättningsfasen med titeln: 'Fastställande av penetrationsdjupet för oxiderande vatten under markytan' avslutats. En ny analysmetod för att bestämma penetrationsdjupet för oxiderande vatten med hjälp av järnoxider har använts på ett antal prover från en borrhärlinje från Laxemar. Resultaten indikerar att sprickor i de övre 50 metrarna för närvarande tidvis utsätts för oxiderande förhållanden och att oxiderande vatten har trängt ner till cirka 90 meters djup utan glacial påverkan.

Swiw-tester med syntetiskt grundvatten utgör ett komplement till testerna och studierna som utförts rörande de processer som styr fördröjningen av radionuklider i berget, till exempel True-experimenten. Förstudien har avslutats och platsen för "True Block Scale" är en av tre kandidatplatser för testerna. I den ursprungliga planen ingick att välja plats för testerna under 2008, detta har dock skjutits på framtiden, då det pågående arbetet med en ny tunnel i närheten av "True Block Scale" blockerar platsen till juni 2009.

Aktiviteterna vid Äspölaboratoriet omfattar projekt med syfte att utvärdera användbarhet och tillförlitlighet hos olika beräkningsmodeller. I arbetet ingår även att utveckla och prova metoder för att bestämma parametervärden som krävs som indata till modellerna. En viktig del av detta arbete genomförs i ett internationellt samarbetsprojekt "*Äspö Task Force on Modelling of Groundwater Flow and Transport of Solutes*". Under 2008 har "Task 6" (användandet av data från platsundersökning i modellering för säkerhetsanalys) avslutats och modellering pågått inom "Task 7" (pumptester under lång tid i Olkiluoto, Finland). I "Task 7" ingår även att studera användandet av data från PFL (Posiva Flow Log) och frågeställningar relaterade till öppna borrhål.

Tekniska barriärer

Verksamheten vid Äspölaboratoriet har som mål att demonstrera funktionen hos förvarets delar. Detta innebär att vetenskapliga och teknologiska kunskaper används praktiskt i arbetet med att utveckla, testa och demonstrera de metoder och tillvägagångssätt som kan komma att användas vid uppförandet av ett slutförvar. Det är viktigt att möjlighet ges att testa och demonstrera hur förvarets delar kommer att utvecklas under realistiska förhållanden. Ett flertal projekt i full skala, liksom stödjande aktiviteter, pågår vid Äspölaboratoriet. Experimenten fokuserar på olika aspekter av ingenjörsteknik och funktionstester.

I *Prototypförvaret* pågår en demonstration av den integrerade funktionen hos förvarets barriärer. Prototypförvaret utgör dessutom en fullskalig referens för prediktiv modellering av slutförvaret och barriärernas utveckling. Prototypförvaret omfattar totalt sex deponeringshål, fyra i en inre tunnelsektion och två i en yttre. Mätningar av relativ fuktighet, portryck, totalt tryck och temperatur i olika delar av testområdet genomförs kontinuerligt. Portrycket i båda sektionerna har fortsatt öka trots att tunneln är dränerad. Både trycket i återfyllningen och vattenutflödet från tunneln har under 2008 påverkats av arbetet med byggandet av en ny tunnel i närheten av prototypförvaret.

I *Lot-försöket* genomförs långtidsförsök på buffertmaterial som syftar till att validera modeller och hypoteser som beskriver bentonitbuffertens fysikaliska egenskaper och processer relaterade till mikrobiologi, radionuklidtransport, kopparkorrosion och gastransport under förhållanden som liknar dem i ett KBS-3-förvar. Under 2008 har ytterligare analyser av långtidsförsökets testpaket (A2) genomförts vid olika laboratorier och de tre återstående testpaketen har fungerat utan några störningar.

Målet med projektet *Alternativa buffertmaterial* är att studera olika lermaterial som i laboratorietester har visat sig vara tänkbara buffertmaterial. Tre paket med olika kombinationer av lermaterial har installerats i borrhål i Äspölaboratoriet. Paketerna ska värmas för att försiktigt höja temperaturen i bufferten till måltemperaturen 130 °C. I två av paketen startades värmarna direkt och måltemperaturen uppnåddes i slutet av år 2007. Bufferten i det tredje paketet var vattenmättad i augusti 2008 och då startades värmarna i detta paket. Under året har även analyser av olika buffertmaterial genomförts.

I *Återfyllningsförsöket* undersöker man den hydrauliska och mekaniska funktionen hos olika återfyllnadsmaterial. Försöket är också en demonstration av olika metoder för inplacering av återfyllnad och installation av tunnelförslutning. Sektionens innersta del är återfylld med en blandning av krossat berg och bentonit medan den yttre delen är återfylld med krossat berg. I slutet av 1999 startade bevätningen av återfyllningen och den blev fullständigt mättad under år 2003. Därefter har flödestester genomförts för att bestämma den hydrauliska konduktiviteten i olika delar av återfyllningen samt kompressibilitetstester. Kontinuerliga mätningar görs av vattentryck, totaltryck och vattenutflöde genom tunnelpluggen.

Återtagningsförsöket syftade till att prova teknik för att återta kapslar efter det att den omgivande bentonitbufferten har vattenmättats. Under 2006 genomfördes ett lyckat återtag av kapseln. Vattenmättnadsfasen hade då pågått i mer än fem år med kontinuerliga mätningar av fukthalten, temperaturen och spänningar. Laboratorieundersökningar på bentonitbufferten från försöket har pågått under 2008 och är i det närmaste avslutade. Resultat har erhållits avseende mekaniska egenskaper, svälltryck, hydraulisk konduktivitet och kemiska/mineralogiska förändringar i bentonitbufferten.

Syftet med *TBT-försöket* är att förbättra förståelsen av buffertens termiska och hydromekaniska utveckling under vattenuppmättnadsfasen vid temperaturer runt eller högre än 100 °C. Experimentet har genererat data sedan starten 2003 och temperaturen runt den nedre värmaren hade i slutet av 2008 gått upp till 150 °C. Utvärderingen av THM-processerna görs genom analyser av sensordata och genom numerisk modellering samt parallellt genom utvärdering och numerisk modellering av laborieförsök utförda av CEA i Frankrike. Det tidigare planerade gasinjekteringsförsöket i den övre bufferten kommer inte att äga rum då genomförda hydrauliska tester visar på att bufferten runt sandskölden inte är tillräckligt tät.

Ett forskningsprogram för ett *KBS-3-förvar med horisontell deponering* (KBS-3H) genomförs som ett samarbetsprojekt mellan SKB och Posiva. Nu pågår en fortsättningsfas av projektet med målsättningen att utveckla KBS-3H till en sådan nivå att beslut kan fattas om fullskaletest. Flera tester har genomförts på -220 m nivån i Äspölaboratoriet under 2008. Genomförda tester med en Megapacker för injektering har varit lyckosamma och tester med deponeringsutrustningen ser lovande ut, men förbättringar måste göras för att den ska bli mer robust. Dessutom har förberedande arbete gjorts för att installera och testa en stålplugg.

Syftet med ett *Gasinjekteringsförsök i stor skala* är att studera gastransport i ett fullstort deponeringshål (KBS-3). Installationsfasen med deponering av kapsel och buffert avslutades under 2005. Vatten tillförs bufferten på konstgjord väg och utvecklingen av vattenmättnadsgraden i bufferten mäts kontinuerligt. Under första kvartalet 2008 avslutades de preliminära hydrauliska testerna och gasinjekteringstesterna. Analys av hydrauliska data visar på ingen eller knappt märkbar påverkan på buffertens egenskaper efter gasinjektering. En andra serie av preliminära gasinjekteringstester kommer att genomföras under 2009 som en del av den nu pågående uppmättnadsfasen. Under 2008 genomfördes även en riktad ansträngning för att kvalitetssäkra data från försöket.

Även om ett förvar kommer att lokaliseras till ett berg av god kvalitet med låg sprickförekomst kommer injektering av berget behövas. Målsättningen med projektet *Tätning av tunnel på stort djup* är att bekräfta att injekteringsmedlet silica sol är ett användbart injekteringsmedel som kan användas vid de höga vattentryck som råder på förvarsdjup. I Äspölaboratoriet på -450 m nivån har

Tass-tunneln drivits för att visa detta. Utbyggnaden av Tass-tunneln startade i slutet av 2007 och har nu nått sin fulla längd om 80 m. Injektering har genomförts i vanliga skärmar utanför tunnelkonturen och i hål innanför konturen. I projektet har man kunnat visa att det går att begränsa inflödet av vatten till de nivåer som efterfrågas för deponeringstunnlar med injektering av silica sol både med skärmar utanför och innanför tunnelkonturen.

Målet med projektet *In situ testning av korrosion av miniatyrkapslar* är att få en bättre förståelse av korrosionsprocesserna inuti en trasig kapsel. Vid Äspölaboratoriet genomförs in situ experiment med miniatyrkopparkapslar med gjutjärnsinsats där kopparkapslarna kommer att utsättas för både naturligt reducerande grundvatten och grundvatten som har jämviktats med bentonit under flera år. I början av 2007 var alla fem kapslar installerade i borrhålen och en rapport som beskriver själva installationen och resultat som erhållits, fram till maj 2008, har tagits fram. Moniteringen av experimentet har fortsatt och data rörande kemiska förhållanden, korrosion av provbitar och ändringar i kapselns storlek mäts kontinuerligt och analyseras.

I projektet *Rensning och förslutning av undersökningsborrhål* ska bästa möjliga tillgängliga teknik identifieras och demonstreras. I platsundersökningarna borrar undersökningsborrhål och en noggrann karakterisering genomförs för att erhålla data på bergets egenskaper. Dessa borrhål måste rensas och pluggas senast när driften av slutförvaret avslutats. Det huvudsakliga arbetet under 2008 har varit karakteriseringen av ett antal undersökningsborrhål i Laxemar och Forsmark. Målet har varit att välja två undersökningsborrhål som är representativa och kan användas som referensborrhål i kommande arbete inom projektet.

Det internationella samarbetsprojektet *”Task Force on Engineered Barrier Systems”*, omfattar i den första fasen av projektet huvudsakligen två områden: (1) THM-processer och (2) gasmigration i buffertmaterial. Under 2006 beslutades det dock att starta upp en parallell *”Task Force”* som behandlar geokemiska processer i ingenjörbarriärer. Två *”Task Force”* möten har hållits under 2008. I *”Benchmark 1”* (laboratorietester) har -modelleringen av THM-processer och gasgenombrottet avslutats. I *”Benchmark 2”* (storskaliga fälttest) har det huvudsakliga arbetet varit modellering av Återtagsförsöket i Äspölaboratoriet och modelleringen av URL-testerna som har avslutats. Laboratorieexperiment och resultat från Lot-försöket har utgjort *”benchmark”* för den geokemiska modelleringen. Två möten har hållits i geokemigruppen för att diskutera hur befintliga generella geokemiska modelleringsverktyg kan anpassas för att förbättra modelleringen av bentonit.

Äspöanläggningen

I Äspöanläggningen ingår både det underjordiska berglaboratoriet och Bentonitlaboratoriet. En viktig del av verksamheten vid Äspöanläggningen är administration, drift och underhåll av instrument samt utveckling av undersökningsmetoder. Målet med driften av Äspöanläggningen är att garantera säkerheten för alla som arbetar eller besöker anläggningen samt att driva anläggningen på ett miljömässigt korrekt sätt. Målet med en tillgänglighet i berglaboratoriet på 98 % uppnåddes som tidigare år även detta år. Bentonitlaboratoriet har varit i full drift under 2008. I laboratoriet har olika metoder och tekniker för installation av pelletar och återfyllningsblock i deponeringstunnlar utförts, men även erosionstester på buffert och återfyllningsmaterial har genomförts. Information och besöksgruppen vid Äspölaboratoriet är ansvariga för att ta fram information om SKB och dess anläggningar. Under 2007, besöktes SKB:s anläggningar och platsundersökningarna i Oskarshamn och Forsmark av ungefär 24 000 besökare.

Miljöforskning

Äspö Miljöforskningsstiftelse grundades 1996 på initiativ av lokala och regionala intressenter, med målsättningen att göra Äspölaboratoriet och dess resurser tillgängliga även för nationell och internationell miljöforskning. Aktiviteterna har sedan 2003 varit koncentrerade till Äspö:s forskarskola. Under 2008 avslutades som planerat forskarskolan och pågående och kommande forskningsaktiviteter överfördes, inom ramen för ett nytt samarbete, till forsknings- och utvecklingsplattformen Nova FoU. Målsättningen är att stödja ny och innovativ forskning där SKB:s stora dataunderlag från geologiska, hydrogeologiska, hydrogeokemiska och ekologiska undersökningar kan användas.

Internationellt samarbete

Förutom SKB har åtta organisationer från sju länder deltagit i det internationella samarbetet vid Äspölaboratoriet under 2008. Sex av dem, Andra, BMWi, CRIEPI, JAEA, NWMO och Posiva utgör tillsammans med SKB "Äspö International Joint Committee" vilken ansvarar för att koordinera det experimentella arbetet som uppkommer från det internationella deltagandet. De utländska organisationerna deltar både i det experimentella arbetet i Äspölaboratoriet och i modelleringsarbetet inom de två Äspö "Task Force"grupperna: (1) "Task Force on Modelling of Groundwater Flow and Transport of Solutes" och (2) "Task Force on Engineered Barrier Systems".

Contents

1	General	15
1.1	Background	15
1.2	Goals	16
1.3	Organisation	16
1.4	International participation in Äspö HRL	17
1.5	Allocation of experimental sites	18
1.6	Reporting	18
1.7	Management system	19
1.8	Structure of this report	19
2	Geoscience	21
2.1	General	21
2.2	Geology	22
	2.2.1 Geological mapping and modelling	22
	2.2.2 Rock Characterisation System	22
2.3	Hydrogeology	23
	2.3.1 Hydro Monitoring Programme	24
2.4	Geochemistry	25
	2.4.1 Monitoring of Groundwater Chemistry	25
2.5	Rock Mechanics	26
	2.5.1 Counterforce Applied to Prevent Spalling	27
3	Natural barriers	29
3.1	General	29
3.2	Tracer Retention Understanding Experiments	30
	3.2.1 True Block Scale Continuation	31
	3.2.2 True-1 Continuation	34
	3.2.3 True-1 Completion	34
3.3	Long Term Sorption Diffusion Experiment	35
3.4	Colloid Transport Project	38
3.5	Microbe Projects	40
	3.5.1 Micored	42
	3.5.2 Micomig	45
	3.5.3 Biocor	45
3.6	Matrix Fluid Chemistry Continuation	47
3.7	Padamot	49
3.8	Fe-oxides in fractures	49
3.9	Swiw-tests with Synthetic Groundwater	53
3.10	Task Force on Modelling of Groundwater Flow and Transport of Solutes	53
4	Engineered barriers	57
4.1	General	57
4.2	Prototype Repository	57
4.3	Long Term Test of Buffer Material	68
4.4	Alternative Buffer Materials	70
4.5	Backfill and Plug Test	72
4.6	Canister Retrieval Test	74
4.7	Temperature Buffer Test	78
4.8	KBS-3 Method with Horizontal Emplacement	82
4.9	Large Scale Gas Injection Test	86
4.10	Sealing of Tunnel at Great Depth	88
4.11	In situ Corrosion Testing of Miniature Canisters	91
4.12	Cleaning and Sealing of Investigation Boreholes	93
4.13	Task Force on Engineered Barrier Systems	95

5	Äspö facility	99
5.1	General	99
5.2	Bentonite Laboratory	99
5.3	Facility operation	101
5.4	Public Relations and Visitor Services	102
6	Environmental research	105
6.1	General	105
6.2	Geochemistry Research Group	106
7	International co-operation	109
7.1	General	109
7.2	Andra	110
7.3	BMWi	110
7.3.1	Microbe Project	110
7.3.2	Prototype Repository	113
7.3.3	Alternative Buffer Materials	116
7.3.4	Temperature Buffer Test	116
7.3.5	Task Force on Engineered Barrier Systems	121
7.4	CRIEPI	122
7.4.1	Task Force on Modelling Groundwater Flow and Transport of Solutes	123
7.4.2	Task Force on Engineered Barrier Systems	128
7.5	JAEA	132
7.5.1	Tracer Retention Understanding Experiments	132
7.5.2	Task Force on Modelling of Groundwater Flow and Transport of Solutes	132
7.6	NWMO	138
7.6.1	Colloid Transport Project	138
7.6.2	Task Force on Modelling of Groundwater Flow and Transport of Solutes	140
7.6.3	Large Scale Gas Injection Test	141
7.6.4	Task Force on Engineered Barrier Systems	142
7.7	Posiva	142
7.7.1	Task Force on Modelling of Groundwater Flow and Transport of Solutes	142
7.7.2	Long Term Test of Buffer Material	143
7.7.3	Alternative Buffer Materials	143
7.7.4	KBS-3 Method with Horizontal Emplacement	143
7.7.5	Large Scale Gas Injection Test	144
7.7.6	Sealing of tunnel at great depth	144
7.7.7	Task Force on Engineered Barrier Systems	144
7.8	Nagra	144
7.8.1	Alternative Buffer Materials	144
7.8.2	Task Force on Engineered Barrier Systems	145
7.9	Rawra	145
7.9.1	Alternative Buffer Materials	145
7.9.2	Task Force on Engineered Barrier Systems	145
8	Literature	149
8.1	References	149
8.2	List of papers and articles published 2008	154
8.3	Documents published 2008	155

1 General

1.1 Background

The Äspö Hard Rock Laboratory (HRL), in the Simpevarp area in the municipality of Oskarshamn, constitutes an important part of SKB's work with design and construction of a deep geological repository for final disposal of spent nuclear fuel. This work includes the development and testing of methods for use in the characterisation of a suitable site. One of the fundamental reasons behind SKB's decision to construct an underground laboratory was to create an opportunity for research, development and demonstration in a realistic and undisturbed rock environment down to repository depth. Most of the research is concerned with processes of importance for the long-term safety of a future final repository and the capability to model the processes taking place. Demonstration addresses the performance of the engineered barriers, and practical means of constructing a repository and emplacing the canisters with spent fuel.

The underground part of the laboratory consists of a tunnel from the Simpevarp peninsula to the southern part of Äspö where the tunnel continues in a spiral down to a depth of 460 m, see Figure 1-1. The total length of the tunnel is 3,600 m where the main part of the tunnel has been excavated by conventional drill and blast technique and the last 400 m have been excavated by a tunnel boring machine (TBM) with a diameter of 5 m. The underground tunnel is connected to the ground surface through a hoist shaft and two ventilation shafts.

The work with Äspö HRL has been divided into three phases: Pre-Investigation phase, Construction phase and Operational phase.

During the *Pre-Investigation phase*, 1986–1990, studies were made to provide background material for the decision to locate the laboratory to a suitable site. The natural conditions of the bedrock were described and predictions made of geological, hydrogeological, geochemical and rock-mechanical conditions to be observed during excavation of the laboratory. This phase also included planning for the construction and operational phases.

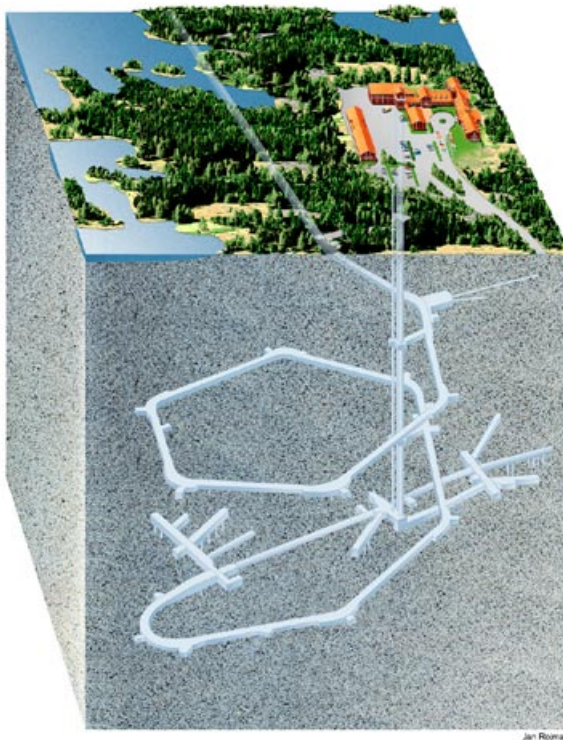

Figure 1-1. Overview of the Äspö HRL facilities.

During the *Construction phase*, 1990–1995, comprehensive investigations and experiments were performed in parallel with construction of the laboratory. The excavation of the main access tunnel and the construction of the Äspö Research Village were completed.

The *Operational phase* began in 1995. A preliminary outline of the programme for this phase was given in SKB's Research, Development and Demonstration (RD&D) Programme 1992. Since then the programme has been revised every third year and the detailed basis for the period 2008–2010 is described in SKB's RD&D-Programme 2007 /SKB 2007/.

1.2 Goals

To meet the overall time schedule for SKB's RD&D work, the following stage goals were initially defined for the work at the Äspö HRL:

1. *Verify pre-investigation methods.* Demonstrate that investigations on the ground surface and in boreholes provide sufficient data on essential safety-related properties of the rock at repository level.
2. *Finalise detailed investigation methodology.* Refine and verify the methods and the technology needed for characterisation of the rock in the detailed site investigations.
3. *Test models for description of the barrier functions at natural conditions.* Further develop and at repository depth test methods and models for description of groundwater flow, radionuclide migration and chemical conditions during operation of a repository as well as after closure.
4. *Demonstrate technology for and function of important parts of the repository system.* In full scale test, investigate and demonstrate the different components of importance for the long-term safety of a final repository and show that high quality can be achieved in design, construction and operation of repository components.

The tasks in stage goals 1 and 2 were after completion at Äspö HRL transferred to the Site Investigations Department of SKB. The investigation methodology has here after been developed in the site investigations performed at Simpevarp/Laxemar in the municipality of Oskarshamn and at Forsmark in the municipality of Östhammar.

In order to reach stage goals 3 and 4 the following important tasks are today performed at the Äspö HRL:

- Develop, test, evaluate and demonstrate methods for repository design and construction as well as deposition of spent nuclear fuel and other long-lived waste.
- Develop and test alternative technology with the potential to reduce costs and simplify the repository concept without sacrificing quality and safety.
- Increase the scientific understanding of the final repository's safety margins and provide data for safety assessments of the long-term safety of the repository.
- Provide experience and train personnel for various tasks in the repository.
- Provide information to the general public on technology and methods that are being developed for the final repository.
- Participate in international co-operation through the Äspö International Joint Committee (IJC) as well as bi- and multilateral projects.

1.3 Organisation

SKB's work is organised into six departments: Technology, Nuclear Safety, Site Investigations, Operations, Environmental Impact Assessment, and Public Information and Business Support. The research, technical development and safety assessment work is organised into the Technology department, in order to facilitate co-ordination between the different activities. Within the Technology department a Technical-scientific council has been set up in order to prepare technical and scientific

issues concerning the research and development of the KBS-3 method. The Council shall in different issues continuously judge the state of development and the need of further work as well as advice on ongoing and planned new projects aimed at development and scientific verifying of the different parts of the KBS-3 method.

The Äspö HRL is one of five units organised under the Technology department and is responsible for the operation of the Äspö facility and the co-ordination, experimental service and administrative support of the research performed in the facility. The Äspö unit is organised in four operative groups and a secretariat:

- *Project and Experimental service (TDP)* is responsible for the co-ordination of projects undertaken, for providing services (administration, planning, design, installations, measurements, monitoring systems etc.) to the experiments.
- *Repository Technology and Geoscience (TDS)* is responsible for the development and management of the geoscientific models of the rock at Äspö and the test and development of repository technology to be used in the final repository.
- *Facility Operation (TDD)* is responsible for operation and maintenance of offices, workshops, the underground laboratory and the bentonite laboratory, and for development, operation and maintenance of supervision systems.
- *Relations and Visitor Services (TDI)* is responsible for presenting information about SKB and its facilities with main focus on Äspö. The laboratories at Äspö and SKB's other research facilities are open to visitors throughout the year.

Each major research and development task is organised as a project that is led by a project manager who reports to the client organisation. Each project manager is assisted by an on-site co-ordinator with responsibility for co-ordination and execution of project tasks at the Äspö facility. The staff at the site office provides technical and administrative service to the projects and maintains the database and expertise on results obtained.

The organisation described above, which has been in place for a number of years, will be changed from the beginning of May 2009. The change involves integration of the present Äspö unit into the unit for Repository Technology, which is currently located in Stockholm. The new integrated unit, Repository Technology, will be organised into six groups and will include personnel in both Äspö and Stockholm.

1.4 International participation in Äspö HRL

The Äspö HRL has so far attracted considerable international interest. During 2008, eight organisations from seven countries in addition to SKB participated in the international co-operation at Äspö HRL. The participating organisations were:

- Agence Nationale pour la Gestion des Déchets Radioactifs (Andra), France.
- Bundesministerium für Wirtschaft und Technologie (BMW), Germany.
- Central Research Institute of Electric Power Industry (CRIEPI), Japan.
- Japan Atomic Energy Agency (JAEA), Japan.
- Nuclear Waste Management Organization (NWMO), Canada.
- Posiva Oy, Finland.
- Nationale Genossenschaft für die Lagerung Radioaktiver Abfälle (Nagra), Switzerland.
- Radioactive Waste Repository Authority (RAWRA), Czech Republic.

Andra, BMW, CRIEPI, JAEA, NWMO and Posiva together with SKB form the Äspö International Joint Committee (IJC), which is responsible for the co-ordination of the experimental work arising from the international participation.

Task Forces are another form of organising the international work. Several of the international organisations in the Äspö co-operation participate in the two Äspö Task Forces on Modelling of: (a) Groundwater Flow and Transport of Solutes and (b) Engineered Barrier Systems.

SKB also takes part in several international EC-projects and participates in work within the IAEA framework.

1.5 Allocation of experimental sites

The rock volume and the available underground excavations are divided between the experiments performed at the Äspö HRL. It is essential that the experimental sites are located so that interference between different experiments is minimised. The allocation of the experimental sites within the underground laboratory is shown in Figure 1-2.

1.6 Reporting

Äspö HRL is an important part of SKB's RD&D Programme. The plans for research and development of technique during the period 2008–2013 are presented in SKB's RD&D Programme 2007 /SKB 2007/. The information given in the RD&D Programme related to Äspö HRL is detailed in the Äspö HRL Planning Report /SKB 2008a/ and this plan is revised annually. Detailed account of achievements to date for the Äspö HRL can be found in the Äspö HRL Annual Reports that are published in SKB's Technical Report series. This report describes the achievements during 2008. In addition, the progress in the projects during the year has also been reported in four Status Reports /SKB 2008b,c, 2009a,b/.

Joint international work at Äspö HRL, as well as data and evaluations for specific experiments and tasks, are reported in Äspö International Progress Report series. Information from Progress Reports is summarised in Technical Reports at times considered appropriate for each project. SKB also endorses publications of results in international scientific journals. Data collected from experiments and measurements at Äspö HRL are mainly stored in SKB's site characterisation database, Sicada.

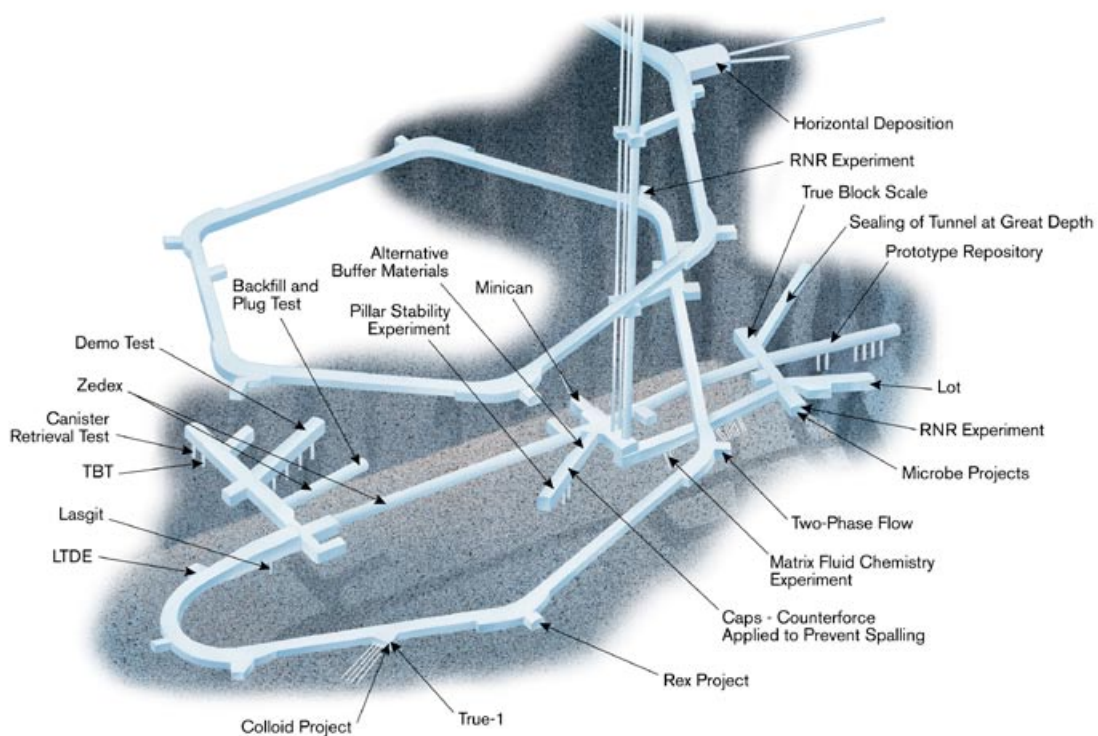

Figure 1-2. Allocation of experimental sites from –220 m to –450 m level.

1.7 Management system

SKB is since 2001 certified according to the Environmental Management System ISO 14001 as well as the Quality Management Standard ISO 9001. Since 2003 SKB is also certified according to the upgraded ISO standard 9001:2000.

The structure of the management system is based on procedures, handbooks and instructions. The overall guiding documents for issues related to management, quality and environment are written as quality assurance documents.

The documentation can be accessed via SKB's Intranet where policies and quality assurance documents for SKB (SD-documents) as well as specific guidelines for Äspö HRL (SDTD-documents) can be found. Employees and contractors related to the SKB organisation are responsible that work is performed in accordance with SKB's management system.

SKB is constantly developing and enhancing the security, the working environment and the quality-control efforts to keep up with the company's development as well as with changes in circumstances. One of the cornerstones of both the existing operations and in the planning of new facilities is the efficient utilisation of available resources.

1.8 Structure of this report

The achievements obtained at Äspö HRL during 2008 are in this report described in six chapters:

- Geoscience – experiments, analyses and modelling to increase the knowledge of the surrounding rock.
- Natural barriers – experiments, analyses and modelling to increase the knowledge of the repository barriers under natural conditions.
- Engineered barriers – demonstration of technology for and function of important engineered parts of the repository barrier system.
- Äspö facility – operation, maintenance, data management, monitoring, public relations etc.
- Environmental research.
- International co-operation.

2 Geoscience

2.1 General

The responsibility of geoscientists at Äspö today involves maintaining and developing the knowledge and methods of the geoscientific field, as well as providing geoscientific support to the various projects conducted at Äspö HRL. Geoscientific research and activities are conducted in the fields of geology, hydrogeology, geochemistry and rock mechanics.

Geoscientific research is a part of the activities at Äspö HRL as a complement and an extension of the stage goals 3 and 4, see Section 1.2. Studies are performed in both laboratory and field experiments, as well as by modelling work. From 2006 the work follows a yearly scientific programme. The overall aims are to:

- Establish and develop geoscientific models of the Äspö HRL rock mass and its properties.
- Establish and develop the knowledge of applicable measurement methods.

A main task within the geoscientific field is the development of the Äspö Site Descriptive Model (SDM). The model will facilitate the understanding of the geological, hydrogeological and geochemical conditions at the site and the evolution of the conditions during operation of the hard rock laboratory. The activities further aim to provide basic geoscientific data to the experiments and to ensure high quality of experiments and measurements related to geosciences. A lot of work during 2008 has been related to the excavation of the Tass-tunnel for the project Sealing of Tunnel at Great Depth, see Figure 2-1.



Figure 2-1. Tunnel front in the excavated Tass-tunnel.

2.2 Geology

The geological work at Äspö HRL is covering several fields. Major responsibilities are mapping of tunnels, deposition holes and drill cores, as well as continuous updating of the geological three-dimensional model of the Äspö rock volume and contribution with input knowledge in projects and experiments conducted at Äspö HRL. In addition, the development of new methods in the field of geology is a major responsibility. As a part of the latter, the project Rock Characterisation System is conducted, see Section 2.2.2.

2.2.1 Geological mapping and modelling

Background and objectives

All rock surfaces and drill cores are mapped at Äspö HRL. This is done in order to increase the understanding of geometries and properties of rocks and structures, which is subsequently used as input in the 3D modelling, together with other input data.

Results

The excavation of the Tass-tunnel (the tunnel for the project Sealing of Tunnel at Great Depth) has continued during 2008 and at the end of the year the tunnel front was at section 80.7 m. Geological mapping of all rock surfaces (tunnel walls, floor and roof) up to section 64.6 m has been performed. Data and drawings have been entered into the Tunnel Mapping System (TMS). The same has been done with all mapped tunnel fronts up to the end of the tunnel. A report concerning the investigations that preceded the excavation of the Tass-tunnel is in preparation. In addition, laser scanning combined with digital photography has been performed in the Tass-tunnel, see Section 2.2.2.

A study regarding possible differences in the mapping procedure and achieved results from geological mapping of a drilled and blasted tunnel and a TBM bored tunnel has been performed and reported /Hultgren 2008/.

The modelling work that commenced in 2005, concerning water bearing fractures at the –450 m level, is completed. Adjustments in the report after being returned from the review are ongoing.

2.2.2 Rock Characterisation System

Background and objectives

A feasibility study concerning geological mapping techniques has been completed. The project Rock Characterisation System (Rocs) was conducted as a SKB-Posiva joint-project. The purpose was to investigate if a new system for rock characterisation has to be adopted when constructing a final repository. The major reasons for the project are aspects on objectivity of the data collected, traceability of the mappings performed, saving of time required for mapping and data treatment and precision in mapping. These aspects all represent areas where the present mapping technique may not be adequate.

Based on the knowledge from the feasibility study SKB has commenced a new phase of the Rocs project. The project will concentrate on finding or constructing a new geological underground mapping system. Laser scanning in combination with digital photography or photogrammetry will be a part of that system. The resulting mapping system shall operate in a colour 3D environment where the xyz-coordinates are known.

Results

- Project decisions and project plan documents for the continuation phase of the project have been written during 2008. The project decisions document has been approved and the project plan is waiting for approval. The work with specification of requirements concerning various parts of the project has started.

- Three laser scanning events, combined with digital photography in the Tass-tunnel, have been completed and the data delivered. The laser scan data from the scanning and digital photography in section 0–64.6 m of the tunnel has been used to create 3D-models of the Tass-tunnel. Tests of software that can handle the laser scan data are also being performed. The report concerning laser scanning combined with digital photography of the Tass-tunnel has been reviewed and adjustments are ongoing. The report is thus delayed and will be printed in 2009. In addition, tests with photogrammetry have been executed in the Tass-tunnel. A SheronCam HDR camera equipped with a light source was used and showed promising results, see Figure 2-2.

2.3 Hydrogeology

The major aims of the hydrogeological activities are to:

- Establish and develop the understanding of the hydrogeological properties of the Äspö HRL rock mass.
- Maintain and develop the knowledge of applicable measurement methods.
- Ensure that experiments and measurements in the hydrogeological field are performed with high quality.
- Provide hydrogeological support to active and planned experiments at Äspö HRL.



Figure 2-2. Tests with new camera equipment (SheronCam HDR) in the Tass-tunnel.

The understanding of the hydrogeology of Äspö has developed over time with a first descriptive model produced 1997 and a second one in 2002. The objective now is to upgrade the existing hydrogeology model by including data collected during 2002–2008. The main features are the inclusion of additional data collected from various experiments and the adoption of the modelling procedures developed during the site investigations. The intention is to develop the model into a dynamic working tool suitable for predictions in support of the experiments in the laboratory as well as to test hydrogeological hypotheses. During 2008, an activity plan for the hydrogeological modelling was drafted.

There is a need to improve the routines and method descriptions for hydrogeological work as well as the procedures for documentation at Äspö. Work with development of quality control and quality assurance procedures has been initiated during 2008.

2.3.1 Hydro Monitoring Programme

Background and objectives

The hydro monitoring programme is an important part of the hydrogeological research and a support to the experiments undertaken in the Äspö HRL. It was conditioned by the water rights court, when granting the permission to execute the construction works for the tunnel, that a monitoring programme should be put in place and that the groundwater head conditions should continue to be monitored until the year 2004.

The monitoring of water level in surface boreholes started in 1987 and the tunnel construction started in October 1990. The tunnel excavation began to affect the groundwater level in many surface boreholes during the spring 1991. A computerised Hydro Monitoring System (HMS) was introduced in 1992 and the first pressure measurements from tunnel drilled boreholes were included in HMS in March 1992. The HMS collects data on-line of pressure, levels, flow and electrical conductivity of the groundwater. The data are recorded by numerous transducers installed in boreholes and in the tunnel. The number of boreholes included in the monitoring programme has gradually increased, and presently it comprises boreholes in the tunnel in the Äspö HRL as well as surface boreholes on the islands of Äspö, Ävrö, Mjälén, Bockholmen and some boreholes on the mainland at Laxemar.

The scientific grounds of maintaining the hydro monitoring programme are to:

- Establish a baseline of the groundwater head and groundwater flow situations.
- Provide information about the hydraulic boundary conditions for the experiments in the Äspö HRL.
- Provide data to various model validation exercises, including the comparison of predicted head with actual head.

Results

During 2008, the hydrogeological monitoring system has been performing well and the monitoring points in the tunnels have been maintained. However, in the surface drilled boreholes a gradual deterioration of the equipment has taken place over the years, to the extent that presently most of the Äspö boreholes are only measured manually or discontinuously. An investigation of potential supporting and corrective measures for the surface boreholes is underway. The monitoring is reported quarterly through the quality control documents. In order to further develop the quality assurance of collected data, work with new quality control documents, activity plans and measurement system descriptions have been initiated.

Support has also been provided to different projects. For example to the project Sealing of Tunnel at Great Depth, to assess the impact of drilling and blasting on hydraulic head and water inflow in tunnels.

2.4 Geochemistry

Background and objectives

The major aims within geochemistry are to:

- Establish and develop the understanding of the hydrogeochemical properties of the Äspö HRL rock volume.
- Maintain and develop the knowledge of applicable measuring and analytical methods.
- Ensure that experimental sampling programmes are performed with high quality and meet overall goals within the field area.
- Provide hydrogeochemical support to active and planned experiments at Äspö HRL.

One of the overall main tasks within the geoscientific programme is to develop an integrated site description of the Äspö HRL. An important part is the compilation of geochemical data. The use of the information generated will facilitate the understanding of the geochemical conditions at the site and the way in which they change during operation. The intention is to develop the model as to be used for predictions, to support and plan experiments, and to test hydrogeochemical hypotheses. This is important in terms of distinguishing undisturbed and disturbed conditions.

In order to find suitable sampling and analytical methods for determination of isotopes in the water and gas phase methods for sampling have been tested in the Äspö tunnel. During the year, sampling of gases has been performed in conjunction with the Microbe project and isotope data has been entered in SKB's site characterisation database (Sicada). Further sampling and analysis are, however, needed to get more reliable data of concentrations and to evaluate whether sampled volumes are enough for analysis of the isotopic composition in the gas phase.

2.4.1 Monitoring of Groundwater Chemistry

Background and objectives

During the Äspö HRL construction phase, water samples were collected and analysed with the purpose of monitoring the groundwater chemistry and its evolution as the construction proceeded. The samples were collected from boreholes drilled from the ground surface and from the tunnel. At the beginning of the Äspö HRL operational phase, sampling was replaced by a groundwater chemistry monitoring programme, with the aim to sufficiently cover the evolution of hydrochemical conditions with respect to time and space within the Äspö HRL.

The monitoring programme is designed to provide information to determine where in the rock mass, the hydrogeochemical changes are taking place and at what time stationary conditions are established. In addition, all ongoing experiments have the possibility to request additional sampling of interest for their projects.

Results

Monitoring of the hydrogeochemical conditions in the groundwater of Äspö was conducted in May and during September/October 2008. The monitoring in May was only a small campaign. The list of the sampled points has changed during the last couple of years. However, several boreholes in the upper bedrock (–50 to –100 m) in the tunnel were dried out and discarded from the sampling programme. In addition, some surface drilled boreholes were discarded from being sampled due to low or no groundwater pressure and failed packed-off sections or due to lowered groundwater level. Chloride concentrations measured in the sampling campaign 2008 are shown in Figure 2-3. Elevated concentrations (>10,000 mg/L) are found in distinct parts of the tunnel at depths between –200 m and –460 m. These relatively high concentrations can be an effect of up-coning or mixing with more saline groundwater, but effects caused by experimental activities can not be excluded. In addition, the chloride concentrations measured in a surface water pond receiving the main outlet water from the Äspö tunnel are shown in Figure 2-3.

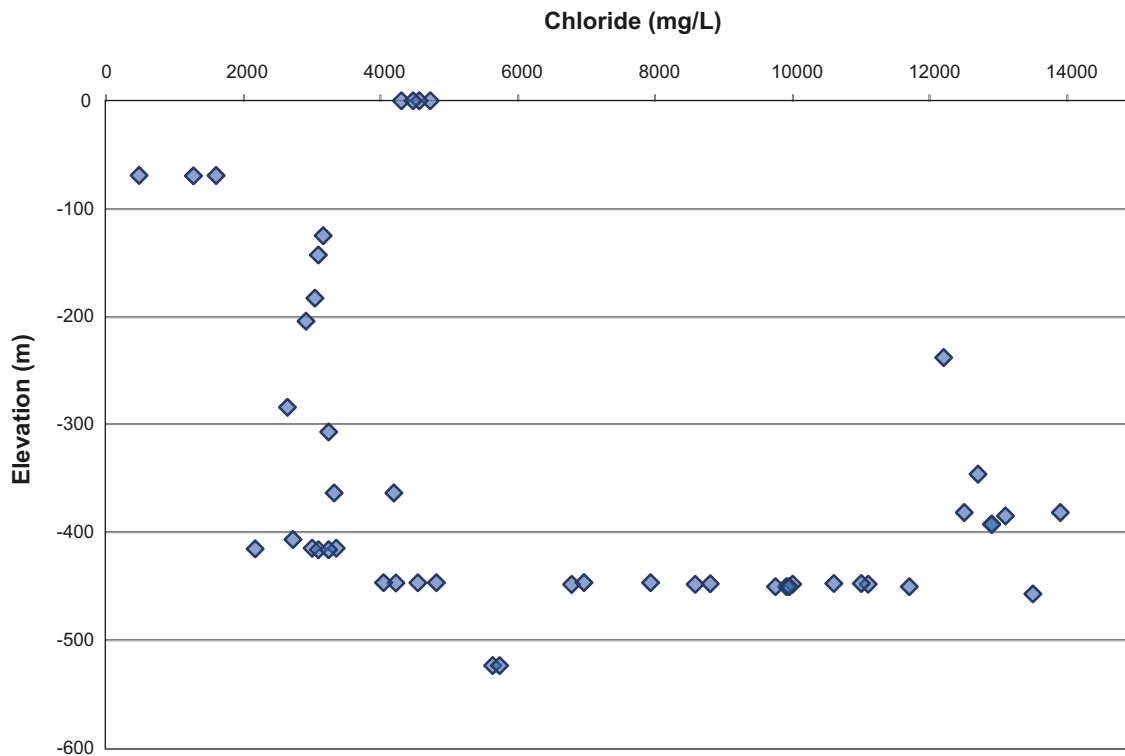

Figure 2-3. Measured chloride concentrations in boreholes at different depths and in a surface water pond (elevation 0 m) receiving the main outlet water from the Äspö tunnel.

In total about 180 samplings of groundwater have been performed within the monitoring programme, the environmental sampling programme and for ongoing projects e.g. microbe related projects, excavation of the Tass-tunnel and installation of the Megapacker in the KBS-3H tunnel in Äspö HRL.

The initial aim of the hydrogeochemical sampling during the construction of the Tass-tunnel was to find out whether it was possible to follow injection activities and how they may affect chemical and colloidal composition in the groundwater. In addition, the possibility of tracing blasting activities and leakage from such activities were included at a later stage. Monitoring of the water chemistry is continuously performed at a few points in the Tass-tunnel. Effects and residues from blasting are minor in the cracks but can be considerable in the solid material which is removed from the tunnel. Concentrations of colloidal particles are also monitored but needs to be further evaluated.

2.5 Rock Mechanics

Rock Mechanics studies are performed with the aims to increase the understanding of the mechanical properties of the rock but also to recommend methods for measurements and analyses. This is mainly done by laboratory experiments and modelling at different scales and comprises:

- Natural conditions and dynamic processes in natural rock.
- Influences of mechanical, thermal and hydraulic processes in the near-field rock including effects of the backfill.

In addition, a project called Counterforce Applied to Prevent Spalling (Caps) comprising field tests in Äspö HRL and numerical modelling is performed, see Section 2.5.1.

2.5.1 Counterforce Applied to Prevent Spalling

Background and objectives

The field experiment within Caps has been initiated as a demonstration experiment to determine if the application of dry bentonite pellets is sufficient to suppress thermally-induced spalling in KBS-3 deposition holes. The experience gained from Äspö Pillar Stability Experiment, conducted between 2002 and 2006, indicated that spalling could be controlled by the application of a small confining pressure in the deposition holes /Anderson 2007/.

Experimental concept

The field tests, that include four pairs of heated half-scale KBS-3 holes, are carried out as a series of demonstration experiments in the Tasq-tunnel. Each test consists of two heater holes with a diameter of 0.5 m and a depth of 4 m separated by a 0.7 m thick pillar, which are surrounded by a number of boreholes equipped with temperature gauges.

The first step in the testing sequence includes heating of one pair of open holes to ensure that spalling will occur and can be observed in the holes. The second step includes heating and observation of spalling in another pair of holes. A 50 mm gap, created between an inner tube and the borehole wall, is filled with a loosely placed pellets substitute (expanded clay). The third and final step is a complementary test that will be carried out to address questions that arise during previous tests.

Results

The heating period in the first test was initiated in the end of August. Compared to the original plans, the heating period was prolonged from two to four weeks, due to a larger heat loss and a slower temperature increase than expected in the test. The cause for the larger heat loss was mainly the system of circulating water that controlled the temperature of the observation cameras installed in the heater holes, which worked as a number of heat exchangers in the holes.

The first test showed large differences in the proportion of observed spalling between the heater holes. The observations indicated that the inflow of water and the natural humidity in the holes had significant influence of the results and that it was important to control this parameter during the tests. The heating and the system of compressed air to keep the camera lenses free from mist resulted in reduced moisture content in the heater holes during the first test. Least amount of spalling was observed in the heater hole with the lowest relative humidity. The drying-up of the boreholes was preliminarily assumed to have caused a slight apparent confinement of the borehole wall due to suction within the borehole boundary. However, the results from the subsequent tests have not confirmed this assumption.

The heterogeneity in the spalling observed in the first pair of heater holes resulted in the decision to perform the next test as a repetition of the first, however, with controlled humidity in the holes this time. The second test was performed in November with a heating period of little more than two weeks. It was accomplished with improved sealing of the heater holes and with a system to moistening the holes through generation of steam by the heater tubes. Furthermore, the observation cameras were excluded in the second test and the occurrence of spalling was instead observed by regular visual inspection and by a mobile video camera.

The performed actions to prevent the rock from drying up during the second test did not result in a more uniform spalling in the heater holes as was expected. The results in the second test showed even larger heterogeneity of the observed spalling between the heater holes. Compared to the first test, the amount of spalling increased in the hole with higher humidity, while the amount of spalling was almost equal in the other hole with lower humidity. The results from the second test indicate that the observed heterogeneity is controlled by additional factors than the humidity in the heater holes, perhaps other geological conditions that correlate with the humidity of the heater holes.

The third test was performed in December 2008, promptly after the second test had been finished. This test included loosely placed pellets of LECA (Light Expanded Clay Aggregates) in a 50 mm gap created between an inner tube and the borehole wall in both heater holes. The test was performed

in an appropriate way although there were problems with some RH-gauges that failed and considerable corrosion of the test equipment in the wet heater hole (KQ0048G04).

The results from this test indicate that the pellets cannot prevent the borehole wall from cracking, whereas it might keep the rock slabs in place and by this minimize the hydraulic transmissivity of the spalled damaged zone. The proportion of spalling between the holes was similar in the third test to what has been observed in previous tests, more in the wetter hole and less in the dryer hole.

Photographs of the heater holes utilised in third test, before and after scaling of the borehole wall, are shown in Figure 2-4 and Figure 2-5. It should be noted that in the part of the borehole wall marked by a circle in Figure 2-4, the spalling occurred mainly before the heating period. The photographs clearly illustrate the heterogeneity in the spalling observations. The results from this test, as well as the previous ones, also demonstrate that it is only in some instance that the thermal induced spalling creates a continuous damaged zone along the borehole wall.



Figure 2-4. Photographs of the north-east-side of heater hole KQ0048G04, the wetter hole in the third test before a) and after b) scaling of the borehole wall.



Figure 2-5. Photographs of the south-west-side of heater hole KQ0048G05, the dryer hole in the third test before a) and after b) scaling of the borehole wall.

3 Natural barriers

3.1 General

To meet Stage goal 3 (see Section 1.2), experiments at Äspö HRL are performed at conditions that are expected to prevail at repository depth to further develop and test methods and models for description of groundwater flow, radionuclide migration and chemical conditions, see Figure 3-1.

The experiments are related to the rock, its properties and in situ environmental conditions. The programme at Äspö HRL includes projects with the aim to evaluate the usefulness and reliability of different conceptual and numerical models and to develop and test methods for determination of parameters required as input to the models. The overall purposes are to:

- Improve the scientific understanding of the final repository's safety margins and provide input data for assessments of the repository's long-term safety.
- Obtain the special material needed to supplement data from the site investigations in support of an application for a siting permit for the final repository.
- Clearly present the role of the geosphere for the barrier functions: isolation, retardation and dilution.

During 2008, the ongoing experiments and projects within Natural barriers were:

- Tracer Retention Understanding Experiments.
- Long Term Sorption Diffusion Experiment.
- Colloid Dipole Project.
- Microbe Projects.
- Matrix Fluid Chemistry Continuation.
- Padamot.
- Fe-oxides in fractures.
- Swiw-tests with Synthetic Groundwater.
- Äspö Task Force on Groundwater Flow and Transport of Solutes.

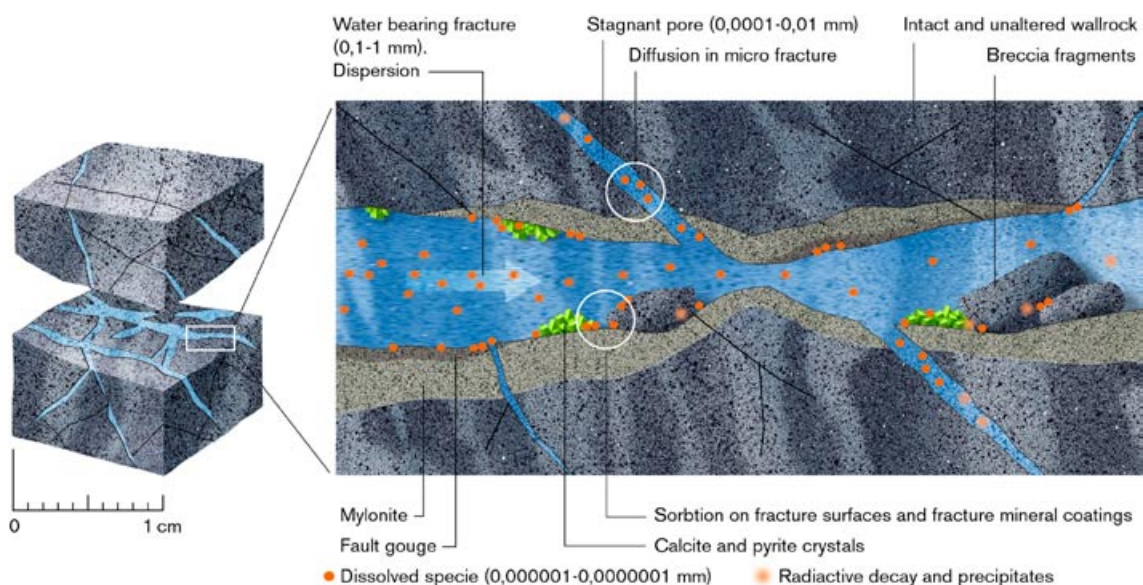

Figure 3-1. Illustration of processes that influence migration of species along a natural rock fracture.

3.2 Tracer Retention Understanding Experiments

Background and objectives

A programme has been defined for tracer tests at different experimental scales, the so-called Tracer Retention Understanding Experiments (True) /Bäckblom and Olsson 1994/. The overall objective of the defined experiments is to increase the understanding of the processes which govern retention of radionuclides transported in crystalline rock, and to increase the credibility in models used for analyses of radionuclide transport in safety assessments.

The True experiments should achieve the following general objectives:

- Improve understanding of radionuclide transport and retention in fractured crystalline rock.
- Evaluate to what extent concepts used in models are based on realistic descriptions of rock and whether adequate data can be collected during site characterisation.
- Evaluate the usefulness and feasibility of different approaches to model radionuclide migration and retention. Provide in situ data on radionuclide migration and retention.

During 2001, it was decided to collect all future True work in two separate projects: True Block Scale Continuation and True-1 Continuation. Although the experimental focus is placed on the respective True experimental sites at the Äspö HRL, integration and co-ordination of experimental activities at and between the sites is emphasised.

Experimental concept

The basic idea is to perform a series of in situ tracer tests with progressively increasing complexity. In principle, each tracer experiment will consist of a cycle of activities beginning with geological characterisation of the selected site, followed by hydraulic and tracer tests. An option is to characterise the tested pore space and analyse tracer fixation using epoxy resin injection. Subsequently, the tested rock volume will be excavated and analysed with regards to flow-path geometry and tracer concentration.

Together with supporting laboratory studies of diffusion and sorption characteristics made on core samples, the results of the in situ tests will provide a basis for integrating data on different scales, and testing of modelling capabilities for radionuclide transport up to a 100 m scale, see Figure 3-2. The integration and modelling of data from different length scales and assessments of effects of longer time perspectives, partly based on True experimental results, is made as part of Task 6 in the Task Force on Modelling of Groundwater Flow and Transport of Solutes, see Section 3.10.

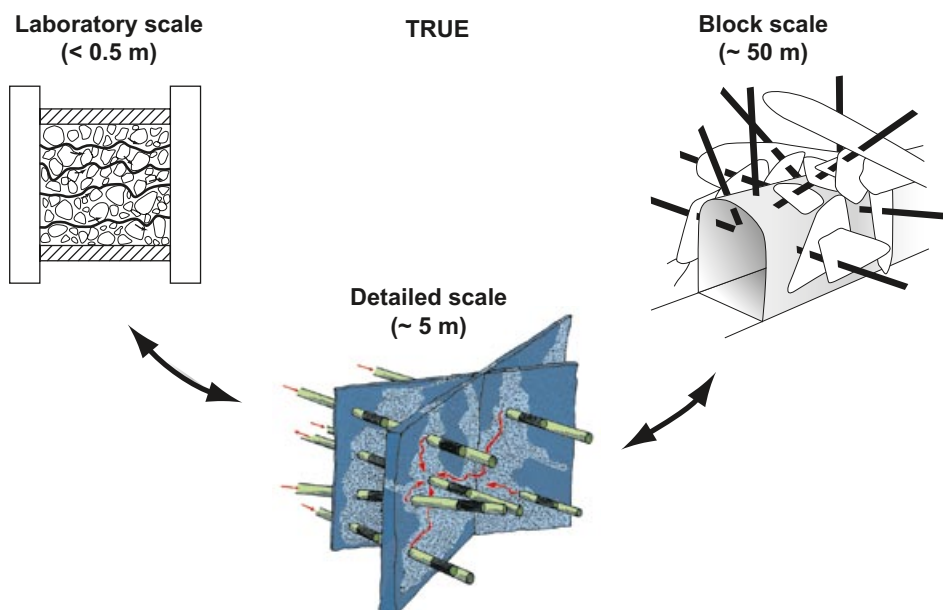

Figure 3-2. Schematic representation of transport scales addressed in the True programme.

3.2.1 True Block Scale Continuation

The True Block Scale Continuation (BS2) project had its main focus on the existing True Block Scale site. Work performed included in situ tracer tests with sorbing tracers and subsequent assessment of the relative retention in flow paths made up of fault rock zones and background fractures. Results verified lower retention material properties in the background fractures flow path but also showed a higher overall retention in this flow path owing to the much lower flow rate therein /Andersson et al. 2007/. In the aftermath to the BS2 project, a second step of the continuation of the True Block Scale (BS3) was set up. This step has no specific experimental components and emphasises consolidation and integrated evaluation of all relevant True data and findings collected so far. This integration would not necessarily be restricted to True Block Scale, but could also include incorporation of True-1 and True-1 Continuation results.

Objectives

Reporting results of the True Block Scale/Block Scale Continuation experiments in the peer-review scientific literature

This work aims to account for the True Block Scale and True Block Scale experimental and modelling in a series of peer-reviewed scientific papers. The aim is further to produce a limited number of peer-reviewed and popularised papers to be published in a high-ranked scientific journal.

Incorporating new experimental data for constraining True retention parameter estimates

The evaluation of the results from True-1 and True-BS tracer tests was based on several simplifying assumptions regarding retention processes. The retention was estimated with a relatively wide range of sorption properties such as K_d and K_a . In situ values of these properties were not available at the time. New data on sorption properties was made available during 2006 from laboratory sorption experiment on rim zone and fault gauge materials. This enabled introduction of new constraints in the evaluation, thereby further reducing the uncertainty in estimated ranges of material retention parameters. Furthermore, True-1 and True-BS tracer test evaluation had given theoretically possible effective (in situ) ranges of the physical retention parameter (hydrodynamic control parameter or “flow-wetted surface”). New data on apertures and matrix porosity estimates was available 2006 (Fault Rock Zones Characterisation Project), from structures not tested by our tracer experiments, but with strong structural relationship with Feature A (True-1) and Structure #20 (True Block Scale). This made it possible to introduce new constraints in the True-1 and True Block Scale evaluations, in order to reduce uncertainty in obtained estimates of physical retention properties (e.g. aperture).

Results

The primary work conducted during 2008 include completion of two drafts of papers in a series of papers evaluating and exploring macro-scale flow-field related constraints for the evaluation of tracer tests performed in the True Block Scale rock volume, using fracture network simulations, /Cvetkovic et al. submitted/ and /Cvetkovic and Frampton, submitted/. A third contribution during the year is an assessment of the role of enhanced porosity in the rock wall immediately adjacent to the fracture /Cvetkovic, submitted/. The latter is an independent paper relevant to both the detailed and block scales.

Evaluation of tracer test results and sensitivity analysis

A total of 17 breakthrough curves from non-sorbing, weakly, moderately and strongly sorbing tracer injections made as part of True Block Scale and True Block Scale Continuation, over length scales between 10–30 m were evaluated /Cvetkovic et al. submitted/. The unlimited diffusion model was found consistent with measured breakthrough curves and used in the evaluation. The four individual retention parameters could not be inferred from breakthrough curves alone and require additional constraints. A consistent trend of the calibrated parameters in relation to laboratory-derived sorption coefficients for the tracers was noted. Sensitivity analysis shows increased sensitivity for the retention parameter as sorption increases. For non-sorbing tracers, diffusion and hydrodynamic dispersion were shown to compete with similar effects, hence their estimates remain uncertain. A consistency in the

observed trends and correlations noted between the True Block scale and True-1 results is observed, which is encouraging for provision of a robust retention model for Äspö diorite. Furthermore, the significance of obtaining additional and independent constraints in order to infer individual parameters, in particular the active specific surface area (sf) and the rock matrix porosity (θ) was demonstrated.

Fracture network flow simulations and global retention properties

Flow and advective transport is simulated in a discrete fracture network (DFN) that replicates the True Block Scale experimental rock volume. The main objective of this work is to reproduce water residence time (τ) and the hydrodynamic control of retention parameter (β) as obtained between five pairs of injection and detection boreholes where non-sorbing and sorbing tracer tests were performed, and use these as independent constraints for estimating material retention properties. The mean and variance of τ and β are computed, assuming two different forms of the hydraulic law linking aperture and transmissivity (empirical quadratic law and theoretical cubic law) with internally homogeneous and heterogeneous fractures. With the mean water residence time as the only robust variable for comparison with measured values, we find that in heterogeneous fractures the quadratic law seems to better reproduce calibrated mean water residence times for the five flow paths. With the computed τ and β , the active specific surface area β/τ can be inferred, and used for defining a generic retention model for the medium grained granitic Äspö diorite which seems to reproduce reasonably well the entire range of calibrated retention parameters of the True tests /Cvetkovic and Frampton, submitted/. We find that the background fractures (with predominantly un-altered rock wall) have lower retention material properties, compared to conductive fractures with altered rock wall. However, due the low transmissivity of the background fracture and relatively large τ and β , the overall retention in the two types of fractures is comparable.

The role of enhanced porosity adjacent to fractures for tracer transport in crystalline rock

Water conducting fractures of crystalline rock are typically subject to multiple events of alteration distributed over geological time. The fracture rim zone, a result of these alterations, will as a rule have different physical and chemical properties, from that of the unaltered rock, depending on the various microscopic and macroscopic factors of the alteration. One characteristic that has been directly verified as part of the True laboratory programme is enhanced porosity adjacent to a conductive fracture, which we refer to as the enhanced porosity zone (EPZ). The zone is extending from fractions of a millimetre to several millimetres, normal to the fracture /Cvetkovic, submitted/.

Characterisation of matrix diffusion in the laboratory of unaltered crystalline rock samples is relatively well established /Skagius and Neretnieks 1986/. Direct characterisation of matrix diffusion under field conditions is, however, far more difficult and uncertain. One reason for this inherent uncertainty is that advective transport in fractures and diffusive fluxes from fractures and into the rock matrix are strongly coupled, which is difficult both to quantify and parameterise in situ. Another complication and source of uncertainty, follows from the fact that unaltered crystalline rock samples are of limited relevance since retention typically takes place in the rim zone of the fracture, with a more or less complex micro-structure due to rock alterations /Bradbury and Green 1986/.

The True tracer tests at Äspö HRL constitute the first comprehensive series of studies of tracer transport in crystalline rock that demonstrate the significance of the rim zone for in situ retention of sorbing and non-sorbing tracers. The laboratory analysis of samples from borehole intercepts at the True-1 test site using the PMMA technique has revealed the existence of an enhanced porosity zone (EPZ) adjacent to the fracture. Specifically, a porosity trend is found with depth, from the fracture surface into the matrix and toward the unaltered rock, see Figure 3-3. Furthermore, there exists a combination of longitudinal variations of altered rock wall porosity that are essentially random and the depth-wise (decreasing trend) of the type shown in Figure 3-3. Longitudinal variability of porosity has been documented and addressed in /Cvetkovic and Cheng 2008/. However, the effect of such porosity trends has not been addressed explicitly, neither for short (experimental) nor for long (safety assessment) time scales. The potential effect of the EPZ on tracer transport of the True-1 tests was addressed by /Cvetkovic and Cheng 2008/ indirectly, by assuming no diffusion beyond the EPZ (limited diffusion model).

The purpose of the work is to study the impact of decreasing porosity in the EPZ, on short- and long-term tracer transport, assuming different micro-structural models and different sorption affinities. The hypothesis of the work is that explicitly accounting for porosity trends in the EPZ can have a significant impact on predictive modelling of tracer transport in crystalline fractures, in particular for strongly sorbing tracers.

The main finding is that the enhanced matrix porosity of the altered rock wall adjacent to fractures can have a profound effect on tracer transport. This effect is more pronounced with stronger sorption affinity of a tracer and longer time scales. An EPZ of less than a millimetre thickness is insignificant for longer time scales if it is assumed as the only retention zone. However, if the overall matrix has a non-zero porosity (typically > 0.001) and is of large extent, the EPZ provides an entrance for the tracer into the matrix where retention is then picked up by relatively strong sorption (since for sufficiently large K_d we have the retardation coefficient inversely proportional to porosity), resulting in potentially significant retardation.

For tracer test time scales < 1 year there is a relatively small impact of the EPZ porosity trend, even for tracers with moderate to strong sorption affinity. A thin EPZ affects the breakthrough curves prior to and around the peak, primarily its magnitude. A thicker EPZ affects primarily the tail part of the breakthrough curves. A consistent shift of the effect, from the peak to the tail, is observed for increasing extent of the EPZ. Significantly, the upper bound porosity (i.e. porosity at the fracture-matrix interface) provides a suitable effective value. Penetration profiles are modestly affected by the EPZ structure compared to the case when effective porosity of the unaltered rock is assumed.

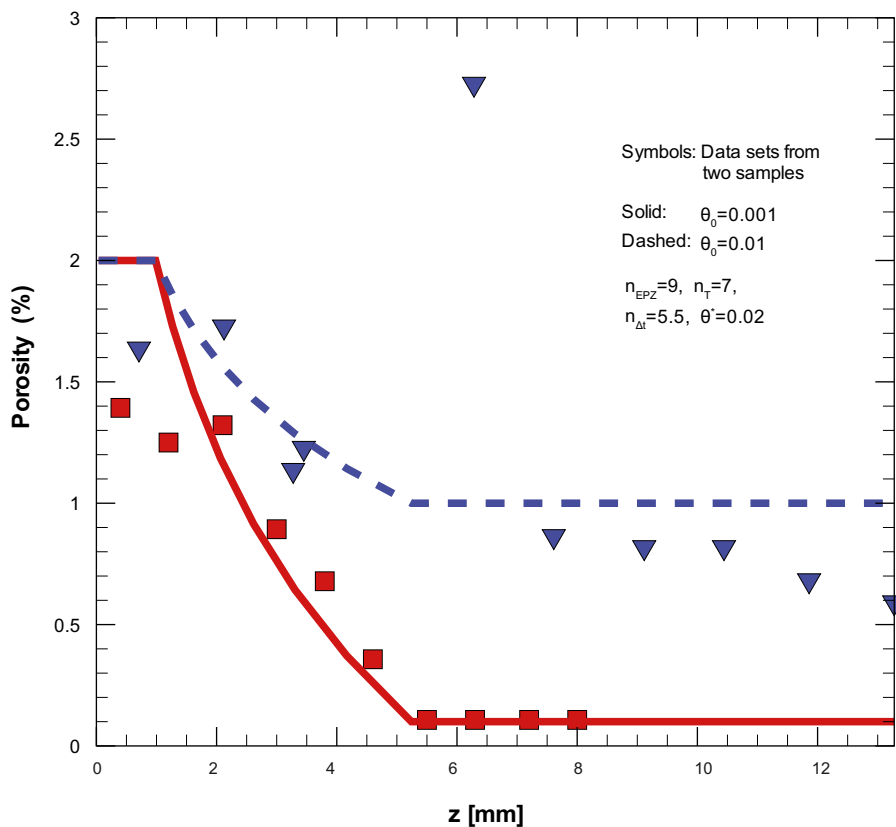

Figure 3-3. Porosity profile up to 13 mm depth for two samples illustrating the enhanced porosity zone (EPZ) up to 4–6 mm /Kelokaski et al. 2001/. Two curves obtained with the trend model are also shown with parameters as specified in the figure.

This work adds further confidence in the interpretation and evaluation of the True tracer tests, where in situ effective matrix porosity was estimated in the range 0.015–0.02. For performance and safety assessment, for instance, the current results indicate that an additional safety margin may exist at least for moderately and strongly sorbing tracers for crystalline rock sites, where fracture alterations are common. In reality, all retention properties are likely to vary spatially, in three dimensions. Further extension of this work would be to account for several of such possible variations that can and explore their relevance for tracer test and safety assessment time scales.

3.2.2 True-1 Continuation

The True-1 Continuation project is an extension of the True-1 experiments, and the experimental focus is primarily on the True-1 site. The continuation includes performance of the planned injection of epoxy resin in Feature A at the True-1 site and subsequent overcoring and analysis (True-1 Completion, see Section 3.2.3). Additional activities include: (a) test of the developed epoxy resin technology to fault rock zones distributed in the access tunnel of the Äspö HRL (Fault Rock Zones Characterisation project), (b) laboratory sorption experiments for the purpose of verifying K_d -values calculated for altered wall rock and fault gouge, (c) writing of scientific papers relating to the True-1 project.

Objectives

The objectives of True-1 Continuation are to:

- Obtain insight into the internal structure of the investigated Feature A, in order to allow evaluation of the pore space providing the observed retention in the experiments performed (see True-1 Completion in Section 3.2.3).
- Provide an improved understanding of the constitution, characteristics and properties of fault rock zones, including fault breccia and fault gouge.
- Provide quantitative estimates of the sorption characteristics of the altered rim zone and fault rock materials of fault rock zones.

The scope of work for the field and laboratory activities includes:

- Characterisation of a number of typical fault rock zones of variable thickness. Injection of epoxy resin and subsequent sampling. Assessment of pore space and quantification of in situ porosity of fault gouge material.
- Writing of three scientific papers accounting for the SKB True Project team analysis of the True-1 experiments.
- Batch sorption experiments on rim zone and fault gouge materials from the True Block Scale site and from other locations along the access tunnel.
- Injection of epoxy resin into the previously investigated Feature A, with subsequent excavation and analyses (True-1 Completion, see Section 3.2.3).

Results

No work has been performed within the True-1 Continuation during 2008.

3.2.3 True-1 Completion

The True-1 Completion project is a sub-project of the True-1 Continuation project with the experimental focus placed on the True-1 site. True-1 Completion constitutes a complement to already performed and ongoing projects. The main activity within True-1 Completion is the injection of epoxy with subsequent over-coring of the fracture and following analyses of pore structure and, if possible, identification of sorption sites. Furthermore, several complementary in situ experiments will be performed prior to the epoxy injection. These tests are aimed to secure important information from Feature A and the True-1 site before the destruction of the site, the latter which is the utter consequence of True-1 Completion.

Objectives

The general objectives of True-1 Completion are to:

- Perform epoxy injection and through the succeeding analyses improve the knowledge of the inner structure of Feature A and to improve the description and identification of the immobile zones that are involved in the noted retention.
- Perform complementary tracer tests with relevance to the ongoing SKB site investigation programme, for instance in situ Kd- and Swiw-test (Single Well Injection Withdrawal).
- Improve the knowledge of the immobile zones where the main part of the noted retention occurs. This is performed by mapping and by mineralogical-chemical characterisation of the sorption sites for Cs.
- Update the conceptual micro structural and retention models of Feature A.

The scope of work for identified field and laboratory activities related to the True-1 site includes:

- Re-instrumentation of boreholes KXTT3 and KXTT4 in order to; (a) ensure that the planned activities at the True-1 site do not in anyway interfere with the other projects at Äspö HRL in general and the Long Term Diffusion Experiment (LTDE) in particular and (b) successfully perform the complementary tracer tests, the epoxy injection and the subsequent over-coring of KXTT3 and KXTT4.
- Complementary tracer tests, Swiw-tests and cation exchange capacity (CEC) tests.
- Epoxy injection, over-coring of KXTT3 and KXTT4, and dismantling of infrastructure at the True-1 site.
- Analysis of core material using picture analysis, microscopy and chemical mineralogy aiming to improve the description of the inner structure of Feature A and possible identification of the immobile zones involved in the noted retention.

Results

The heavy engagement of the project members in the SKB site investigation programme was identified as a clear risk for the progress of the project during 2008. Unfortunately, this became reality with the consequence that only very limited human resources were available for the project. The only major activity during the year was a discussion of plan for the upcoming analyses of core material, from the over-coring of KXTT3 and KXTT4, at a project meeting and a reference group meeting. These discussions resulted in a modification of the activity plan and a slightly different priority of the core material and the analyses methods to be used within the activity plan.

3.3 Long Term Sorption Diffusion Experiment

Background

The Long Term Sorption Diffusion Experiment (LTDE-SD) constitutes a complement to performed diffusion and sorption experiments in the laboratory, and is a natural extension of the performed in situ experiments, e.g. the True-1 and the True Block Scale experiments. The difference is that the longer duration (approximately 5–7 months) and the well controlled geometry of the experiment is expected to enable an improved understanding of diffusion and sorption both in the vicinity of a natural fracture surface and in the matrix rock.

Matrix diffusion studies using radionuclides have been performed in several laboratory experiments. Some experimental conditions such as pressure and natural groundwater composition are however difficult to simulate with good stability in long-term laboratory experiments. Investigations of rock matrix diffusion at laboratory scale imply that one uses rock specimens in which damage due to drilling and unloading effects (rock stress redistribution) may have caused irreversible changes of the rock properties. Matrix diffusion in non-disturbed rock is therefore preferably investigated in situ. Through the proposed experimental technique one will also obtain some information of the adsorption behaviour of some radionuclides on exposed granitic rock surfaces.

Objectives

The LTDE-SD experiment aims at increase the scientific knowledge of sorption and diffusion under in situ conditions and to provide data for performance and safety assessment calculations. Specific objectives of LTDE-SD are to:

- Obtain data on sorption properties and processes of individual radionuclides on natural fracture surfaces and internal surfaces in the matrix.
- Investigate the magnitude and extent of diffusion into matrix rock from a natural fracture in situ under natural rock stress conditions and hydraulic pressure and groundwater chemical conditions.
- Compare laboratory derived diffusion constants and sorption coefficients for the investigated rock fracture system with the sorption behaviour observed in situ at natural conditions, and to evaluate if laboratory scale sorption results are representative also for larger scales.

Experimental concept

A core stub with a natural fracture surface is isolated in the bottom of a large diameter telescoped borehole. In addition a small diameter borehole is drilled through the core stub into the intact undisturbed rock beyond the end of the large diameter borehole. A cocktail of non-sorbing and sorbing tracers are circulated in the test section for a period of approximately 5–7 months after which the core stub is over-cored, and analysed for tracer content and tracer fixation.

The experiment is focussed on a typical conductive fracture identified in a pilot borehole (KA3065A02). A telescoped large diameter borehole (300/197 mm) (KA3065A03) is drilled sub-parallel to the pilot borehole in such a way that it intercepts the identified fracture some 10 m from the tunnel wall and with an approximate separation of 0.3 m between the mantel surfaces of the two boreholes.

The natural fracture as seen on the surface of the stub is sealed off with a polyurethane cylinder and a peek lid, which constitutes a cup-like packer. The remainder of the borehole will be packed off with a system of one mechanical and two inflatable packers. The small diameter (36 mm) extension is packed off using a double packer system leaving a 300 mm long section that will be exposed for the radionuclides. The system of packers and an intricate pressure regulating system will be used to eliminate the hydraulic gradient along the borehole, see Figure 3-4.

During the circulation of tracer, samples of water will be collected at various times over the duration of the experiment. The redox situation in the circulation loop will be monitored continuously with a flow through electrochemical cell, which will measure pH, Eh and temperature. After completion of tracer circulation, the core stub will be over-cored, sectioned and analysed for different radionuclide tracers.

The project also involves a variety of mineralogical, geochemical and petrophysical analyses. In addition, laboratory experiments with the core material from KA3065A03 (Ø 277, 177 and 22 mm) and the fracture “replica” material will be performed. Both “batch” sorption and through diffusion experiments are planned.

Results

The small diameter (24 mm) sample cores have been scanned with scintillation detector and mass spectrometry to get a first measure of total activity before they were geologically mapped in detail. The sample cores, 18 from the core stub and 16 from the matrix rock, have subsequently been cut into thin slices and scanned with autoradiography followed by geological mapping to get a qualitative measure on the distribution of the tracers in the rock slice. To allow determination of sorption and penetration profiles of the different tracers used in the experiment several sample preparation methods and analysis techniques have been necessary to adopt. Rock slices from half of the sample cores have been crushed, grinded and divided into sub-samples, series (a) and (b). Crushed samples, series (a), from five sample cores extracted from fracture surface on the core stub and four sample cores extracted from the matrix rock have been selected for the ongoing dissolution and subsequent analysis of ⁹⁹Tc, ¹⁰²Pd, ²³⁶U, ²³⁷Np using mass-spectrometry (ICP-SFMS) and analysis of ⁶³Ni using liquid scintillation (LSC).

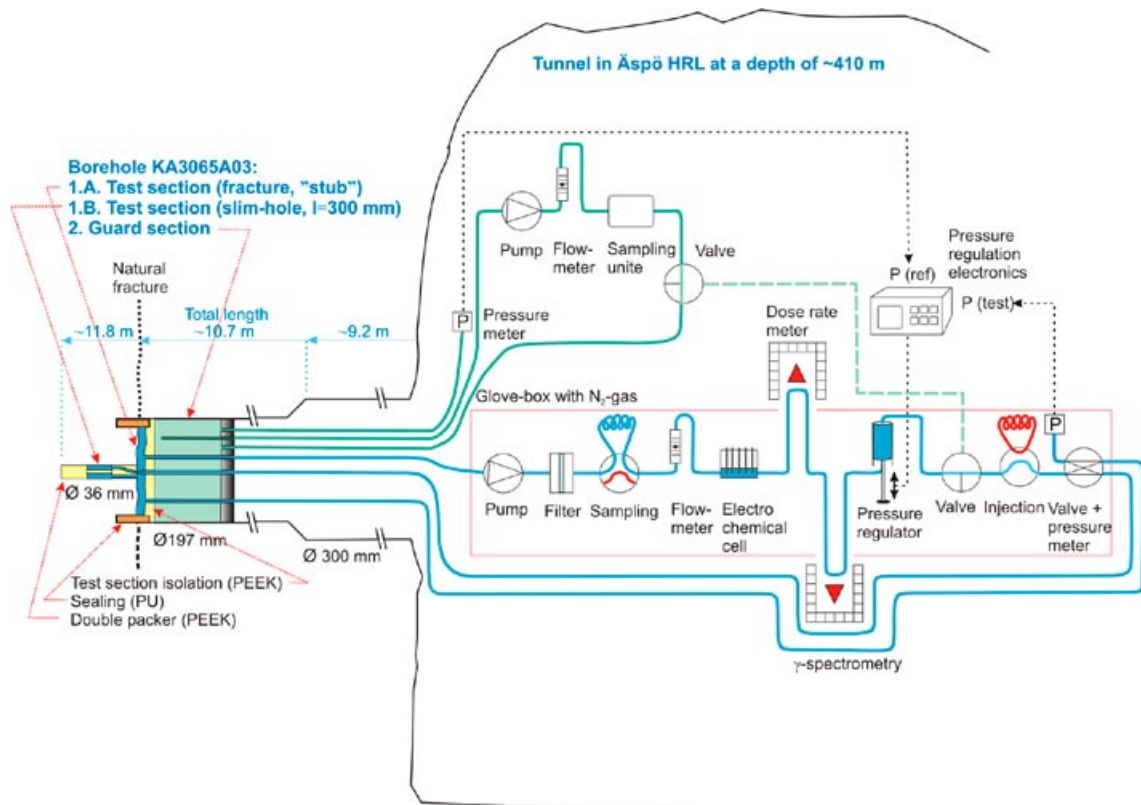

Figure 3-4. LTDE-SD experimental set-up in the experimental borehole including the water circulation system to the test-section and the hydraulic pressure control system.

The results of mass spectrometry measurements show ^{237}Np in amounts well above reporting limit but only in the first slice, i.e. the slice in contact with the tracer labelled groundwater. However, also the presence of ^{236}U is indicated in some first slice samples. To prevent cross contamination during drilling for extraction of the sample cores, the rock surface was coated with epoxy resin. There are indications that tracers adsorbed on the rock surface were removed with the epoxy coating. This is further investigated.

Analysis of the γ -emitting tracers (^{22}Na , ^{57}Co , ^{75}Se , $^{110\text{m}}\text{Ag}$, ^{109}Cd , ^{133}Ba , ^{137}Cs , ^{153}Gd and ^{226}Ra) are in progress at SKB Baslab at Clab for sub-samples series (b) and intact rock slices using an HPGe γ -detector. Preliminary results for six sample cores show penetration depth to about 30 mm for ^{137}Cs and about 45 mm for ^{22}Na and in Figure 3-5 an example of penetration profiles is shown.

At the SKB Baslab laboratory at Äspö the γ -detector and belonging electronics have been changed. A more efficient detector and recently checked and served electronics have been installed aiming at secure faultless operation and speeding up measurements.

Laboratory experiments with specimen from the core of the small diameter extension borehole, the replica core stub and the pilot borehole core are ongoing at Chalmers University of Technology according to the experimental plan. The same tracer cocktail as for the in situ experiment, with tritiated water added, is used for batch sorption tests and diffusion tests. Based on preliminary results from four samples the effective diffusivity (D_e) is calculated to about $4 \cdot 10^{-14} \text{ m}^2/\text{s}$, which is in accordance with the results obtained from the supporting laboratory experiments performed by AECL Whiteshell laboratories /Vilks et al. 2005/, on specimen from the large diameter core (270 mm).

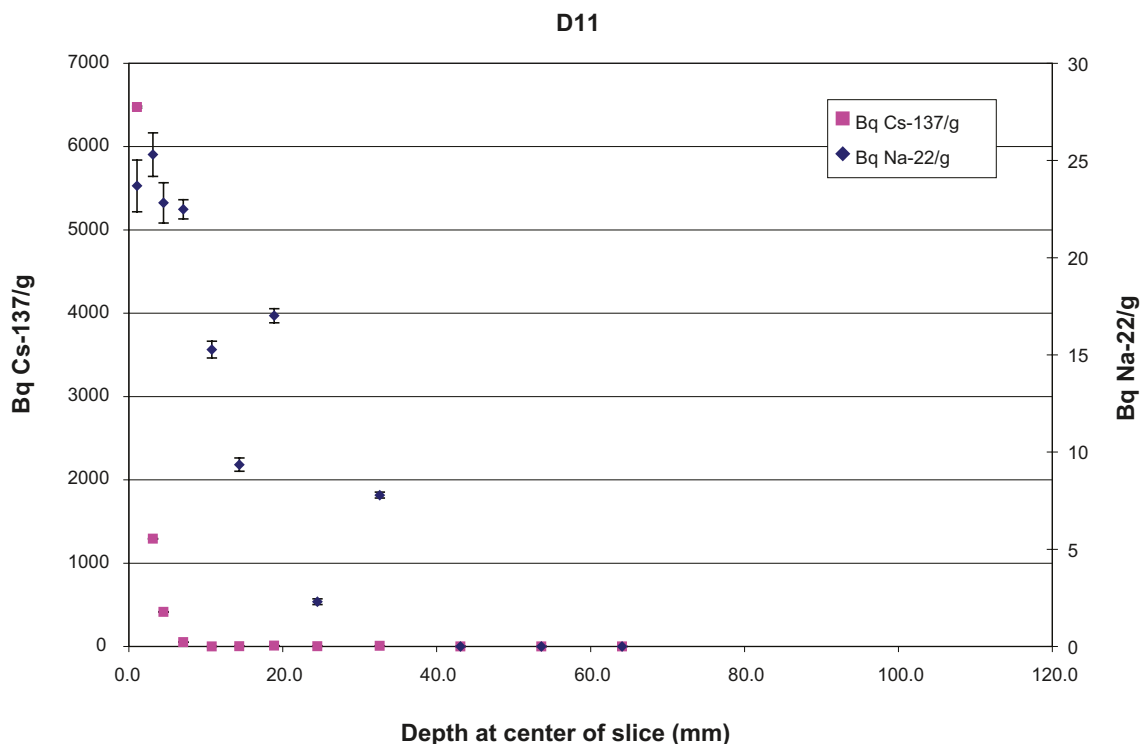

Figure 3-5. Penetration profile for Cs-137 and Na-22 in matrix rock (sample core D11).

3.4 Colloid Transport Project

Background

Colloids are small particles in the size range of 10^{-6} to 10^{-3} mm. Because of their small size and their often negatively charged surfaces in neutral pH, they have the potential to transport radionuclides from a defect waste canister towards the biosphere. Of special interest is that the bentonite buffer under specific conditions, in contact with dilute glacial water, can release colloids, i.e. bentonite can be eroded. Bentonite erosion would not only endanger the buffer functionality, but could also facilitate transport of radionuclides sorbed onto bentonite colloids.

SKB has for more than ten years conducted field monitoring of natural colloids. The outcome of the studies performed nationally and internationally concluded that the colloids in the Swedish granitic bedrock consist mainly of clay, silica and iron hydroxide particles and that the mean concentration is around 20–45 ppb which is considered to be a low value /Laaksoharju et al. 1995/. The low colloid concentration is controlled by often high salinities in deep old granitic groundwater and also by filtration in filling material etc. which reduces both the stability of the colloids and their mobility in aquifers. Low concentrations of organic colloids are found in these types of groundwater, where the concentrations decrease with depth.

It has been argued that e.g. plutonium is immobile owing to its low solubility in groundwater and strong sorption onto rocks. Field experiments at the Nevada Test Site, where hundreds of underground nuclear tests were conducted, indicate however that plutonium is transported as colloids in the groundwater. The $^{240}\text{Pu}/^{239}\text{Pu}$ isotope ratio of the samples established that an underground nuclear test 1.3 km north of the sample site is the origin of the plutonium /Kersting et al. 1999/. Also other radionuclides from the nuclear test source were shown to have travelled far by colloidal transport, for example Co associated to clay colloids.

The findings of potential transport of solutes by colloids and access to more sensitive instruments for colloid measurements motivated a Colloid Project at Äspö HRL. The project was initiated by SKB in 2000 and in the end of 2004 the Colloid Dipole project started as a continuation. The Colloid Dipole ended 2007, and the project is now proceeding under the name Colloid Transport. The project is planned to continue to 2010.

Objectives

The overall goal of the project is to determine in what conditions colloid transport is significant in the system of a deep bedrock repository of spent nuclear fuel. Two important questions that are important to try to answer within the project is when colloid transport should be taken into account in the safety assessment, and how the colloid transport should be include into modelling. More specific the aims and objectives are to:

- Investigate under what conditions the bentonite barrier can release colloids.
- Study stability and transport of bentonite colloids in dilute to saline groundwater.
- Study actinide and bentonite colloid transport in dilute to more saline groundwater.
- Study stability and transport of other types of natural inorganic and organic colloids in dilute to saline groundwater.
- Monitor background concentrations of colloids in granitic groundwater.
- Study radionuclide – colloid interactions in dilute to saline groundwater.

The results from the project will be used mainly in the future development of safety assessment modelling of bentonite erosion and radionuclide migration in the presence of bentonite as well as of other natural colloids.

Experimental concept

The project comprises laboratory experiments as well as field experiments and colloid transport modelling. The following topics are included in the project:

- *Stability of colloids.* Stability of colloids in solution is a key factor since if they are stable they have the potential to be transported long distances. The effects of the groundwater composition on bentonite colloid stability have been extensively studied. The individual and combined effects of pH, ionic strength, and cation composition, presence of organic or other natural colloids have been investigated in the laboratory. Also effects of temperature and exposure of irradiation have been studied /García-García et al. 2006, 2007/.
- *Colloid transport.* Bentonite colloid transport in water bearing fractures is studied in well characterised fractures on different scales. The colloid transport in a fracture is influenced by flow, aperture distribution, surface roughness, physical filtration and sorption onto fracture walls. The effects of the colloid characteristics on the transport, as colloid size distribution, colloid conformation, surface charge and density are taken into account in the experiments /Vilks and Miller 2006/. Bentonite erosion experiments are also performed with a bentonite source installed in the fracture. The release and transport of the colloids are studied. Bentonite colloid transport as well as bentonite generation/erosion is to be studied at the Grimsel Test Site. The Colloid Transport project is a member of the Colloid Formation and Migration (CFM) collaboration in Grimsel.
- *Transport modelling* is performed on the colloid transport experiments in fractures with different length and aperture distributions, as well as with gauge minerals and without. The vision is to be able to model colloid transport in any fracture with different apertures, roughness and minerals with colloids of different size, shape and origin.
- *Actinide transport* in the presence of bentonite colloids in well characterised bore cores from Äspö will be conducted. In addition, actinide transport in the presence of natural colloids, such as organic degradation products, will be investigated for the Äspö bore cores.

Results

New experiments with X-ray micro spectroscopy have been performed at Pollux Beamline at the Swiss Light Source at PSI. The experiments are performed to determine structure and geometry of montmorillonite colloids originating from MX-80 and Febex montmorillonite equilibrated in solution. An article is published in Applied Geochemistry /Degueldre et al. 2009/.

Sedimentation and generation tests on MX-80 have been performed to try to quantify bentonite colloid concentrations at equilibrium outside the bentonite buffer in varying groundwater compositions. An article is published in *Journal of Colloid and Interface Science* /García-García et al. 2009/.

Batch sorption experiments studying the radionuclide bentonite reversibility in presence of fracture filling materials from Äspö and Grimsel have been conducted using a cocktail of radionuclides spiked to natural groundwater from Grimsel. The results are summarised in an activity report for the project. The sorption data will be summarised and sent to a scientific journal for publication. In addition, studies of sorption characteristics of irradiated bentonite colloids are ongoing.

The first phase on modelling of bentonite colloids in a fracture in a granite block is finished. The retention can now be quantified and the ambition is to couple the retention to chemical and physical processes such as physical filtration and sedimentation. The results were presented in an oral presentation at MRS in Boston December 2008 and is published in MRS 2009 proceedings /Cheng and Cvetkovic 2009/. Modelling activities in the CFM Grimsel project are ongoing.

Mock-up tests of erosion/generation of Na- and Ca-montmorillonite have been performed with artificial Plexiglas fractures of 1 and 5 mm aperture. Milliporwater and artificial Grimsel groundwater have been used in these experiments. Different flows have been used and the different phases of the propagated gel has been analysed with XRD for the mineral content. The mock-up tests are now summarised and will be presented in an article. The results were presented at the CFM-experimental planning meeting in Tokyo in November 2008. Further an erosion/generation test has been performed in the Quarried Block and the results are under evaluation.

Transport studies of colloids in filling material are initiated in columns in the laboratory. The aim of these experiments is to quantify physical filtration and sorption of colloids to fracture filling material in varying groundwater chemistry. Preliminary results of latex colloid migration of different sizes in quartz columns were presented in an oral presentation at MRS in Boston in December 2008 and a manuscript is in preparation.

3.5 Microbe Projects

Microbial processes

Microorganisms interact with their surroundings and in some cases they greatly modify the characteristics of their environment. Several such interactions may have a significant influence on the function of a future deep repository for spent fuel /Pedersen 2002/. There are presently four specific microbial process areas identified that are of importance for proper repository functions and that are best studied at the Microbe laboratory. They are: microbial effects on the chemical stability of deep groundwater environments, bio-mobilisation of radionuclides, bio-immobilisation of radionuclides and microbial corrosion of copper.

The study of microbial processes in the laboratory gives valuable contributions to our knowledge about microbial processes in repository environments. However, the concepts suggested by laboratory studies must be tested in a repository like environment. The reasons are several. Firstly, at repository depth, the hydrostatic pressure reaches close to 50 bars, a setting that is very difficult to reproduce in the microbiology laboratory. The high pressure will influence chemical equilibrium and the content of dissolved gases. Secondly, the geochemical environment of deep groundwater, on which microbial life depends and influence, is complex. Dissolved salts and trace elements, and particularly the redox chemistry and the carbonate system are characteristics that are very difficult to mimic in a university laboratory. Thirdly, natural ecosystems, such as those in deep groundwater, are composed of a large number of different species in various mixes /Pedersen 2001/. The university laboratory is best suited for pure cultures and therefore the effect from consortia of many participating species in natural ecosystems cannot easily be investigated there. The limitations of university laboratory investigations arrayed above have resulted in the construction and set-up of an underground laboratory in the Äspö HRL tunnel. The site is denoted the Microbe laboratory.

The Microbe laboratory

The Microbe laboratory is situated at the –450 m level in the F-tunnel. A laboratory container has been installed with laboratory benches and a climate control system. Three core drilled boreholes, KJ0050F01, KJ0052F01 and KJ0052F03, intersect water conducting fractures at 12.7, 43.5 and 9.3 m, respectively. They are connected to the Microbe laboratory via 1/8" PEEK tubing. The boreholes are equipped with metal free packer systems that allow controlled circulation of groundwater via respective fracture /Pedersen 2000/. Each borehole has been equipped with two circulation systems offering a total of 2,112 cm² of test surface in each circulation flow cell set up (four flow cells) for biofilm formation at in situ pressure, temperature and chemistry conditions. One system is metal free and one system is made of stainless steel, see Figure 3-6. The systems operate at pressures around 25 bars. The flow through the flow cells is adjusted to 25–30 ml per minute, which corresponds to a flow rate over the surfaces of about 1 mm per second. Temperature is controlled and kept close to the in situ temperature at around 15–16°C. Remote alarms and a survey system have been installed for high/low pressure, flow rate and temperature. A detailed description of the Microbe laboratory can be found in /Pedersen 2005/ and as original work published in scientific papers /Nielsen et al. 2006, Hallbeck and Pedersen 2008/.

There are presently four specific microbial process areas identified that are of importance for proper repository functions and that are best studied at the Microbe laboratory within separate projects. They are: Microbial effects on the chemical stability of deep groundwater environments (Micored), bio-mobilisation of radionuclides (Micomig), bio-immobilisation of radionuclides (Micomig) and microbial corrosion of copper (Biocor).



Figure 3-6. Three of the circulation systems in the Microbe laboratory, for details see /Nielsen et al. 2006/.

3.5.1 Micored

Background and objectives

Micro-organisms can have an important influence on the chemical situation in groundwater /Haveman and Pedersen 2002/. Especially, they may execute reactions that stabilise the redox potential in groundwater at a low and, therefore, beneficial level for the repository. It is hypothesised that hydrogen from deep geological processes contributes to the redox stability of deep groundwater via microbial turnover of this gas. Hydrogen, and possibly also carbon mono-oxide and methane energy metabolisms will generate secondary metabolites such as ferrous iron, sulphide, acetate and complex organic carbon compounds. These species buffer towards a low redox potential and will help to reduce possibly introduced oxygen /Banwart et al. 1994/. The circulations in the MICROBE laboratory have microbial populations that are reproducible in numbers and species distribution over time under stable hydrological conditions. All groups execute influence on the redox situation. Anaerobic microbial ecosystems generally force the redox potential towards the range of redox in which they are active. Iron and manganese reducing bacteria are active at higher redox potentials (approximately -100 to -200 mV) than the methanogens and acetogens (approximately -300 to -400 mV). Sulphate reducing bacteria are most active between the optimal redox potentials for those groups (approximately -200 to -300 mV). The stable populations of sulphate reducing bacteria and methanogens and acetogens at the MICROBE laboratory makes it very well suited for research on the influence of microorganisms on the evolution and stability of redox potential in groundwater.

The major objectives for the Micored project are to:

- Clarify the contribution from microorganisms to stable and low redox potentials in near- and far-field groundwater.
- Demonstrate and quantify the ability of microorganisms to consume oxygen in the near- and far-field areas.
- Explore the relation between content and distribution of gas and microorganisms in deep groundwater.
- Create clear connections between investigations of microorganisms in the site investigations for a future repository and research on microbial processes at Äspö HRL.

Results

The development and testing of several methods for estimating the total numbers of microorganism groups and amounts of their biomass in groundwater, their diversity, and the rates of microbial processes have been published /Hallbeck and Pedersen 2008/. A methodology that analysed microbial process rates was developed and tested under open and closed controlled in situ conditions in a circulation system in the MICROBE laboratory. The sulphide and acetate production rates were determined to be 0.08 and 0.14 mg L⁻¹ day⁻¹, respectively (Figure 3-7). The numbers of sulphide- and acetate-producing micro-organisms increased concomitantly in the analysed circulating groundwater. Flushing the sampled circulation aquifer created an artefact, as it lowered the sulphide concentration. Microbial and inorganic processes involved in sulphur transformations are summarised in a conceptual model, based on the observations and results presented here. The model outlines how dissolved sulphide may react with ferric and ferrous iron to form solid phases of iron sulphide and pyrite. Sulphide will, consequently, continuously be removed from the aqueous phase via these reactions, at a rate approximately equalling the rate of production by microbial sulphate reduction.

Modelling of microbial processes studied in Micored

A conceptual model program, tentatively denoted Microbe, has been developed. The Microbe program was developed to be able to simulate the development of conditions over time in a confined space resembling a fracture in bedrock. The conditions simulated by Microbe are the concentrations of acetate, sulphate, sulphide, hydrogen gas and microorganisms. The way to achieve this was to develop a simulation approach and a simulation model with a set of properties and describe in mathematical terms how these properties interact with initial conditions in the model and how these conditions change over time. The following conceptual microbial reactions are considered by the Microbe program:

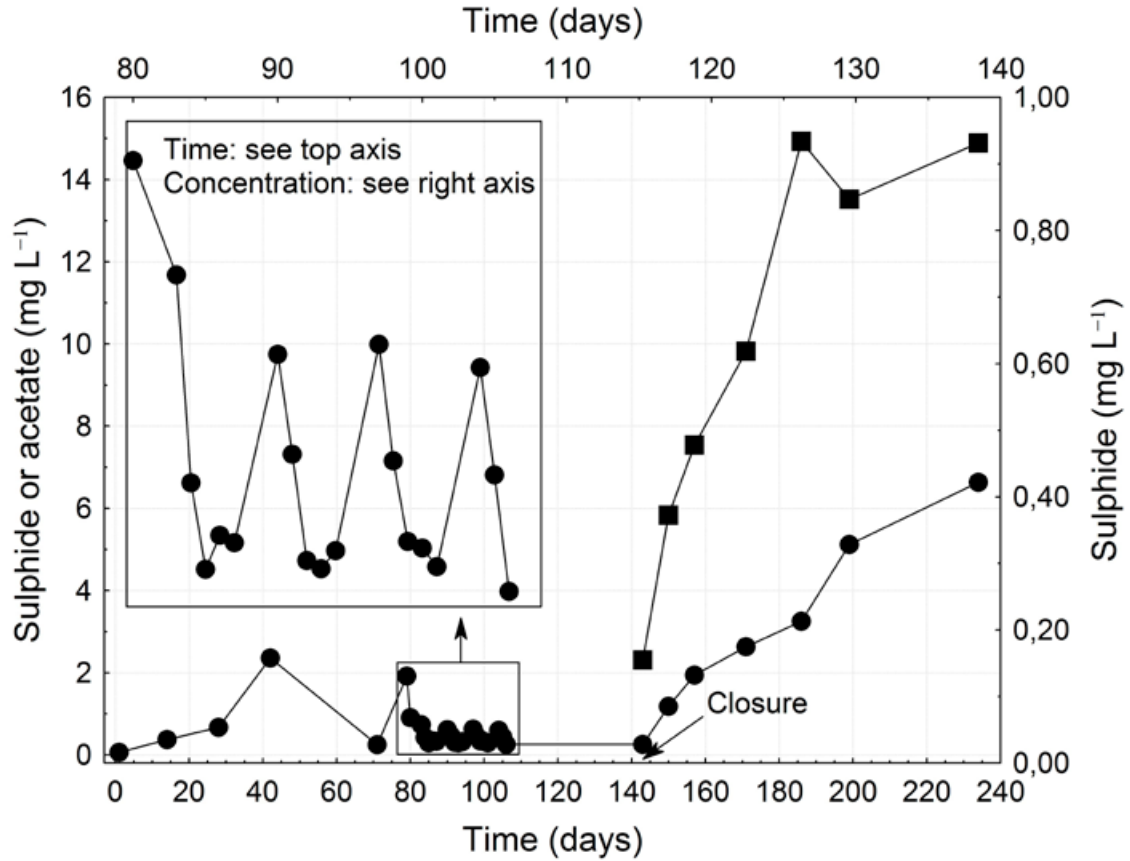
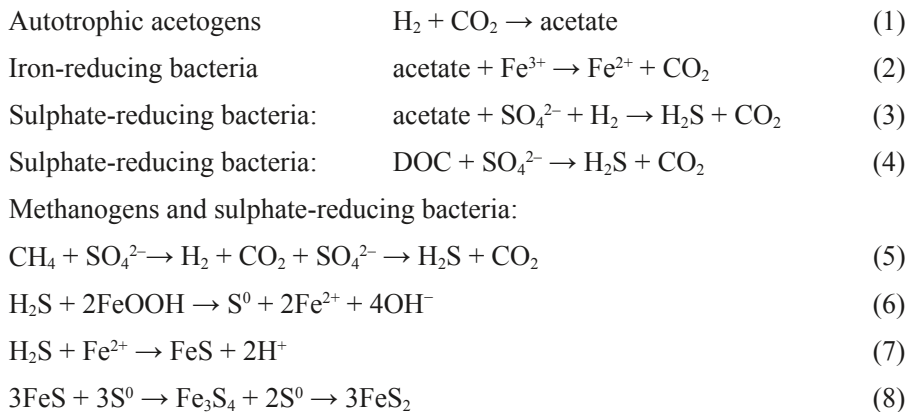

Figure 3-7. The concentrations of sulphide (●) and acetate (■) over an open (0–140 days) and a closed (140–230 days) period in a circulation system under in situ pressure (0.3 MPa) and chemistry conditions at –450 m in Äspö HRL from /Hallbeck and Pedersen 2008/.



Description of the analysed processes

In an arbitrary aquifer at the repository depth, autotrophic acetogens (AA) produce acetate from hydrogen and carbon dioxide at a rate determined by the inflow of hydrogen (1). The produced acetate can be utilised by iron reducing bacteria as a source of carbon and energy; as a result, ferrous iron and carbon dioxide are formed from ferric iron minerals and acetate, respectively (2). Sulphate-reducing bacteria (SRB) oxidize the acetate produced by AA to carbon dioxide, while sulphate is reduced to sulphide (3). Several genera of SRB can oxidize acetate, but species belonging to *Desulfovibrio* need hydrogen to be able to utilise acetate. If degradable organic carbon is available, SRB will also produce sulphide and carbon dioxide from this energy and carbon source (4). A special type of sulphate reduction is coupled to anaerobic methane oxidation (5). This reaction is common in

many marine, sedimentary environments, but has not yet been demonstrated in deep groundwater. If present, it would have a significant impact on any sulphide production model, because the analysed concentration of methane in deep groundwater is generally much higher than the analysed hydrogen /Pedersen et al. 2008/. Microbial reactions 1–5 result in the production of sulphide, ferrous iron, acetate, and carbon dioxide. Hydrogen sulphide from reactions 3–5 may reduce iron in minerals such as goethite with the formation of elemental sulphur and ferrous iron (6). The ferrous iron produced in reactions 2 and 6 can form iron sulphide with hydrogen sulphide (7). This is a solid compound, and the dissolved sulphide that reacts with ferrous iron in reaction 7 will leave the groundwater and precipitate. Finally, pyrite may form (8) when over-saturation occurs.

The simulation model in the Microbe program

The simulation model in Microbe is cylindrical with volume and width specified by the user and filled with water holding concentrations of acetate, sulphate, sulphide, hydrogen and microorganisms, see Figure 3-8. The microorganisms in the water metabolise acetate, sulphate and hydrogen. They also produce sulphide and reproduce. The microorganisms do not die unless they are predated by phages. The rate of reproduction and predation of the microorganisms and the metabolic rates of the microorganisms is calculated on the basis of constants and inputs from the user of Microbe. In the simulation model there are also phages. The inside of the cylinder is completely covered by an infinitely thin bio-film consisting of microorganisms that metabolises acetate, sulphate and hydrogen and produces sulphide. The surface cell density of the bio-film is presently set as a constant and thus does not change during a simulation. There are two separate inflows into the simulation model. The flow rates of the two inflows are specified by the user and there is always an outflow from the model that is equal to the sum of the two inflows. The contents of these inflows are specified by the user. The concentrations in the simulation model are always homogenous.

The screenshot shows the 'Microbe Inputs 1' and 'Microbe Inputs 2' panels. The 'Microbe Inputs 1' panel includes fields for SRB (cells/mL), IRB (cells/mL), Initial [Carbon source] (µM), Type of carbon source (Methane, Acetate, Lactate), Initial [SO4] (µM), Initial [H2] (µM), Initial [S2-] (µM), Initial [Fe2+] (µM), Fe3+ present in fracture? (No/Yes), Inflow 1 (mL/s), Inflow 2 (mL/s), Reactor volume (m3), Reactor aperture (mm), Simulation time (days), Consider bio films? (No/Yes), Consider predation by phages? (No/Yes), and Save simulation to file? (No/Yes). The 'Microbe Inputs 2' panel includes Time step (s), SRB phage ceiling (cells/mL), SRB phage threshold (cells/mL), IRB phage ceiling (cells/mL), IRB phage threshold (cells/mL), Generation time SRB (days), Generation time IRB (days), Surface cell density SRB (cells/mm2), Surface cell density IRB (cells/mm2), Carbon growth efficiency SRB (0-1), Carbon growth efficiency IRB (0-1), KmCarbon (µM), KmSO4 (µM), KmH2 (µM), and Sulphate metabolism SRB (µmol/cell s). Buttons for 'Start simulation', 'More Inputs', and 'Back to Inputs 1' are visible at the bottom.

Figure 3-8. The input panels of the simulation program Microbe. This program calculates in situ growth and activity of microorganisms in groundwater. The background data for program functions and constants have been generated at the Microbe site and in the laboratory with microorganisms isolated from Äspö HRL.

3.5.2 Micomig

Background and objectives

It is well known that microbes can mobilise trace elements /Pedersen 2002/. Firstly, unattached microbes may act as large colloids, transporting radionuclides on their cell surfaces with the groundwater flow /Pedersen and Albinsson 1991, 1992/. Secondly, microbes are known to produce ligands that can mobilise soluble trace elements and that can inhibit trace element sorption to solid phases /Johnsson et al. 2006, Essén et al. 2007, Moll et al. 2008a, b/. A large group of microbes catalyse the formation of iron oxides from dissolved ferrous iron in groundwater that reaches an oxidising environment /Ferris et al. 1999, 2000/. Such biological iron oxide systems (Bios) will have a retardation effect on many radionuclides. Typically, microbes form stalks and sheaths that increase the volume of the iron oxides from densely packed inorganic oxides to a fluffy, rust-like material with water contents of up to 99%. The microbes contribute to the exposure of a large oxide area to trace elements flowing by with the groundwater and the organic biological material adds a strong retention capacity in addition to iron oxides /Anderson and Pedersen 2003, Anderson et al. 2006c/.

Biofilms in aquifers will influence the retention processes of radionuclides in groundwater. Work by /Anderson et al. 2006a, b/ indicates that these surfaces adsorb up to 50% of the radionuclides in natural conditions with K_a (m) approaching 10^5 and 10^6 for Co and Pm respectively. The formation of colloids accounted for a further 20% to 40% of aqueous Co and Pm complexation. The anaerobic biofilms and rock surfaces share similar adsorption capacities for Pm but not for Co. The biofilms seemed to isolate the rock surface from the groundwater as diffusion to the rock surface must first proceed through the biofilms. The possible suppression of adsorption by biofilms needs further research. So far this has been observed only with one biofilm type in one Microbe laboratory circulation.

The major objectives for the Micomig project are to:

- Evaluate the influence from microbial complexing agents on radionuclide migration.
- Explore the influence of microbial biofilms on radionuclide sorption and matrix diffusion.

Results

Drilling along a fracture with a 300 mm drill produced a 500 mm long drill core with fracture surfaces. The drilling was performed during October at tunnel length 1,362 m in a small niche. Protocols were developed to sample DNA and RNA from the fracture surfaces. In November, new drillings were made, with methods developed and based on the first drilling occasion. This time 76 mm cores were drilled across a water conducting fracture at the inner wall of the niche. Five drill cores were obtained that intersected the fracture at a range of 90 to 467 cm from the opening in the niche. The drilling went very well and sampling was successful. The surfaces carried black, white and purple fracture filling material with biofilms, see Figure 3-9. A total of 60 samples distributed over the five cross sections were obtained for DNA and RNA analysis. The flowing groundwater and the drill water were also analysed for DNA and RNA. In addition, some chemical analyses were performed. Preliminary results suggest that the analysis of DNA on fracture surfaces reveal the parts of the fracture that have been in contact with flowing water.

3.5.3 Biocor

Background

Bio-corrosion research has been ongoing in periods at the Microbe laboratory. Two new papers have been published that relate to survival and activity of sulphate-reducing bacteria. The first paper describes the presence of *Desulfovibrio africanus* in Wyoming bentonite MX-80 /Masurat et al. 2008a/. This species seems to be adapted to survive in bentonite. The second paper deals with the potential for sulphide production in compacted bentonite /Masurat et al. 2008b/. The Biocor work has been continued and the new data have been analysed and modelling of diffusion and production of sulphide in compacted bentonite has been completed.

The presence of sulphate-reducing bacteria (SRB) indigenous to the Wyoming MX-80 bentonite was investigated /Masurat et al. 2008a/. This clay has been used for many of the buffer and backfill experiments in the Äspö tunnel. Bentonite was used as an inoculum for enrichment cultures with a medium selective for SRB. The enrichment cultures were re-inoculated to achieve pure cultures, and DNA was extracted from these. The phylogenetic analysis demonstrated that 16S rDNA gene sequences in all



Figure 3-9. Intersected fracture with fracture filling material obtained during drilling for analysis of DNA and RNA in biofilms in the KA362A6 borehole.

the pure cultures were similar to that of *Desulfovibrio africanus*. Further experiments revealed that SRB from the enrichment cultures could grow in temperatures of up to 40°C and sulphide production was detected in the enrichment cultures growing in salt concentrations from 0.7% to 4.0%. These results, combined with a sigmoid morphology of cells in the pure cultures, supported our conclusion that *D. africanus* was present in the bentonite. In addition, dry bentonite was treated for 20 h in 100°C dry heat before incubation in the growth medium. SRB in the bentonite survived and were viable after this treatment. The results indicate that SRB are present in commercial bentonite and that they can survive in a state of desiccation in bentonite at high temperatures and salinity.

Results

The bentonite work above was followed up in the Microbe laboratory. The activity of SRB in Wyoming bentonite MX-80 saturated with groundwater from the -450 m level in Äspö HRL was investigated in situ /Masurat et al. 2008b/. The bentonite was compacted to densities of 1.5, 1.8, and 2.0 g cm⁻³. Lactate was added to the bentonite as a source of energy and organic carbon for SRB. Radioactive sulphur (³⁵SO₄²⁻) was used as a tracer of sulphide production. The copper sulphide (Cu_x³⁵S) that was produced was localized and quantified using electronic autoradiography.

The mean copper sulphide production rates observed were 1.5·10³, 3.1·10², and 3.4·10¹ fmol Cu_xS mm⁻² day⁻¹ at densities of 1.5, 1.8, and 2.0 g cm⁻³, respectively. The use of sterile-filtered (0.2 µm) groundwater resulted in sulphide production of 1.5·10² and 2.4·10¹ fmol Cu_xS mm⁻² day⁻¹ at densities of 1.5, 1.8, and 2.0 g cm⁻³, respectively. Additional in situ experiments were performed with sterile-filtered (0.2 µm) groundwater and bentonite that had been heated to 120°C for 15 h. Sulphide production rates in the heated bentonite were 1.3–16 times lower than in controls treated at 25°C. These results reveal bentonite to be a source of SRB, in addition to the groundwater. Furthermore, all experiments demonstrated that increasing bentonite density correlated with decreasing copper sulphide production rates. However, as there was a short period in the total experimental time frame of 80 days where the bentonite compaction was below the required values, it was deemed possible that some of the sulphate-reducing activity occurred before full compaction. New experiments were designed where the bentonite was set to full compaction before the start of the corrosion tests. This design would ensure that the analysed copper corrosion only could be due to sulphide diffusing from the outside of the bentonite and from microbial sulphate reduction inside the bentonite at the tested densities. By application of a range of densities from 1,750 up to 2,000 kg/m³ it was deemed possible to establish if there is a density limit at which all sulphide production inside the bentonite cease.

Bentonite was compacted to densities of 1,750, 1,800, 1,850, 1,900, 1,950 and 2,000 kg/m³. Three experimental units with copper test surfaces were installed at the Microbe laboratory site. Groundwater from KJ0052F01 was connected under in situ pressure for 30 days and thereafter circulated through a titanium filter over the bentonite and back to the borehole for an additional 30 days. This configuration simulated experiments performed previously on the Microbe site. The bentonite in the oedometers was first allowed to reach full swelling pressures and water saturation under a period of 60 days. Thereafter, various additions were made to the experimental units resulting in three different cases. The first case was denoted “Control”, the second case was denoted “H₂/CO₂” and the third case was denoted “Lactate”. All three cases were added with 2.39 mL of a solution with 5.0 mCi ³⁵SO₄. The corresponding specific activity was 55.5 TBq/mmol. The Total amount of added ³⁵SO₄ was 3.84·10⁻⁸ M. In addition, the H₂/CO₂ case was added with 56 mL of a gas mixture with 80% hydrogen and 20% carbon dioxide. The “Lactate” case was added with 1 mL of a 5.7 M solution of lactate in water. The resulting concentration of lactate became 30 mM. The three units were then left for incubation under in situ pressure for 120, 130 and 130 days, respectively. At the end of incubation, the units were detached and transported to the laboratory in Göteborg for sampling and analysis. The amount of sulphide that reached the copper surfaces was modelled with a three-dimensional diffusion program. The amount of sulphide that could be ascribed to diffusion from the circulating water outside the bentonite was separated from the amount of sulphide produced inside the compacted bentonite. A small, but significant sulphide producing activity was again found in the compacted bentonite at all densities tested up to 2,000 kg/m³. The amounts of sulphide found were in the same order as was found previously /Masurat et al. 2008b/.

3.6 Matrix Fluid Chemistry Continuation

Background and objectives

The first phase of the Matrix Fluid Chemistry experiment (1998–2003) increased the knowledge of matrix pore space fluids/groundwaters from crystalline rocks of low hydraulic conductivity ($K < 10^{-10}$ ms⁻¹), and this complemented the hydrogeochemical studies already conducted at Äspö. The results of this first phase were published in early 2004 /Smellie et al. 2003/.

The continuation phase (2004–2006) focussed on the remaining areas of uncertainty:

- The nature and extent of the connected porewaters in the Äspö bedrock (chemical, hydraulic and transport properties).
- The nature and extent of the microfracture groundwaters which penetrate the rock matrix (chemical, hydraulic and transport properties) and the influence of these by in- and out-diffusion on the chemistry of the porewaters.
- The confirmation of rock porosity values previously measured in the earlier studies.

This continuation phase also saw the completion of a feasibility study to assess the effects on the matrix borehole and its surroundings due to the untimely excavation of a new tunnel for the Äspö Pillar Stability Experiment carried out in April/May 2003. There was concern that repercussions from this excavation may have influenced the hydraulic (and therefore the hydrochemical) character of the matrix borehole and the host rock vicinity. The following objectives were identified:

- To establish the impact of tunnel construction on the matrix borehole by evaluating the monitored pressure profiles in the hydro monitoring system (HMS) registered on the isolated borehole sections during the period of construction (small-scale).
- To establish the impact of tunnel construction on boreholes located in the near-vicinity of the matrix borehole in the F-tunnel by similar means (large-scale).
- If the evaluation indicates that the rock hosting the matrix borehole has been unaffected by tunnel construction, the experiment will proceed first to hydrochemically and hydraulically characterise the presently isolated borehole sections containing microfractures and, secondly, to hydrochemically and hydraulically characterise the original fracture-free borehole sections.
- To carry out additional porosity measurements on drillcore samples to be compared with values already measured.

Experimental concept

The first phase of the Matrix Fluid Chemistry Experiment was designed to sample matrix porewater from predetermined, isolated borehole sections. The borehole was selected on the basis of: (a) rock type, (b) mineral and geochemical homogeneity, (c) major rock foliation, (d) depth in the tunnel, (e) presence and absence of fractures and (f) existing groundwater data from other completed and ongoing experiments at Äspö HRL.

Special downhole equipment (Figure 3-10) was constructed ensuring: (a) an anaerobic environment, (b) minimal contamination from the installation, (c) minimal dead space in the sample section, (d) the possibility to control the hydraulic head differential between the sampling section and the surrounding bedrock, (e) in-line monitoring of electrical conductivity and drilling water content, (f) the collection of porewaters (and gases) under pressure and (g) convenient sample holder to facilitate rapid transport to the laboratory for analysis.

This experimental equipment, with some modifications, was used in the continuation phase from 2005-11-28 through to 2006-08-11 to sample groundwater from the microfractures and to measure the hydraulic parameters of the microfractures and the rock matrix.

Results

Because of other priorities, final reporting of the matrix pore water chemistry and the matrix borehole hydraulic studies is presently ongoing.

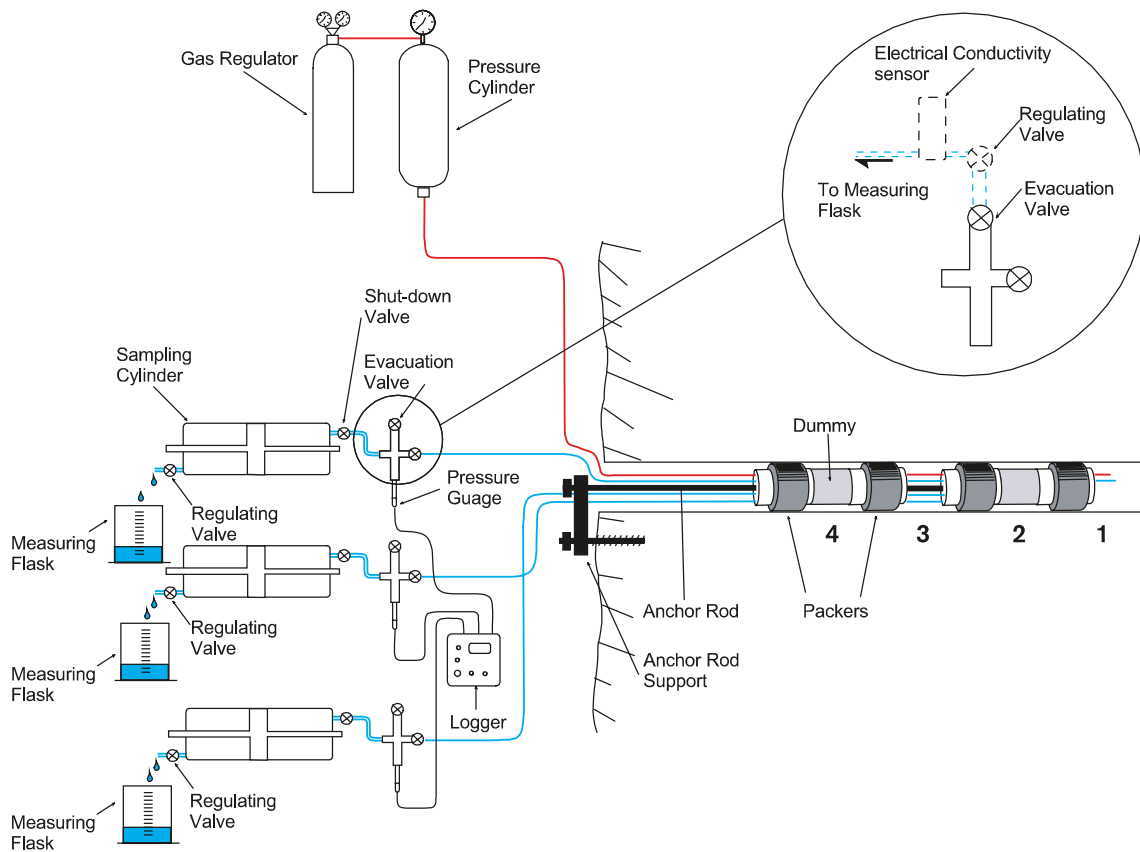

Figure 3-10. Matrix Fluid Chemistry experimental set-up. Borehole sections 2 and 4 were selected to collect matrix fluid and sections 1–4 were continuously monitored for pressure.

3.7 Padamot

Background and objectives

Palaeohydrogeology is a relatively new term used as a common name for information from fracture minerals that is used for interpretations of past hydrogeochemical and hydrogeological systems. The need for such interpretations has become evident in the geological/hydrogeological modelling of sites within the radwaste programmes of several countries. An EC-founded three-year project with the name Equip (Evidences from Quaternary Infills for Palaeohydrogeology) was therefore started in 1997. When the Equip project ended in 2000 /Bath et al. 2000/ there was a need for continued fracture mineral investigations and model testing of the obtained results. A new EC-project called Padamot (Palaeohydrogeological Data Analysis and Model Testing) was therefore initiated in the beginning of 2002 and was ended and reported to EC in 2005. A continuation of the Swedish part of the project at Äspö has thereafter been agreed by SKB.

The objectives for the continuation of the Padamot project include:

- Further developments of analytical techniques for uranium series analyses applied on fracture mineral samples and inter-laboratory comparison.
- Focus on the use of these analyses for determination of the redox conditions during glacial and postglacial time.
- Summarise the experiences of palaeohydrogeological studies carried out at Äspö.

Results

The usefulness of uranium-series analyses has been discussed for long time and a number of case studies (Scandinavia and the UK) show clearly that uranium-series analyses describe mobilisation and deposition of uranium that have taken place in the last 1 million years. Usually, near surface samples show mobilisation of uranium during oxidising conditions which can be followed by deposition deeper down. Clear signs of mobilisation and deposition are usually found in the upper 50 to 100 m. The depth of the perturbed zone will vary from a few meters down to several hundred meters depending on the hydrology, rock type, fracture coatings and fracture frequency.

In order to test different methods analyses of fracture coatings from open fractures from surface to depth of about 200 m (borehole KAS17) have been carried out within the present project in order to test methodology (inter-laboratory study). The analytical work is finished and the interpretative part has started. Initial evaluation of the bulk analyses support the expected picture of mobilisation in the uppermost part of the rock (upper 15–20 m) followed by samples with complex mobilisation/deposition patterns over to deposition and in the deepest sample more close to equilibrium condition. The first results from the sequential leaching analyses support the results from the bulk analyses and add also information on the portion of uranium being mobile. Noteworthy is the significant uranium in the AAC (ammonium acetate) fraction, which represents easily accessible (sorbed) uranium. Two samples (20.38 m and 102.6 m) show the highest portion of uranium in this fraction which supports the results from the uranium-series results that were typical for recent uranium accumulation in these two samples, see Figure 3-11. The project will proceed into an interpretation and reporting phase during 2009, where analyses from the two laboratories involved (Helsinki University and Scottish Universities Research and Reactor Centre) will be integrated.

3.8 Fe-oxides in fractures

Background

Uptake of radioactive elements in solid phases can lead to immobilisation, thus minimising the release to the environment. The extent of uptake depends on solution conditions such as concentration, pH, Eh, temperature, pressure and the presence of other species. Transition metals, lanthanides and actinides are often incorporated by identical processes. Therefore, better understanding of the behaviour of the two first groups mentioned strengthens the understanding also of the actinides, which are difficult to study. Moreover, the presence of trace components in minerals can provide information about a mineral's genesis conditions and history.

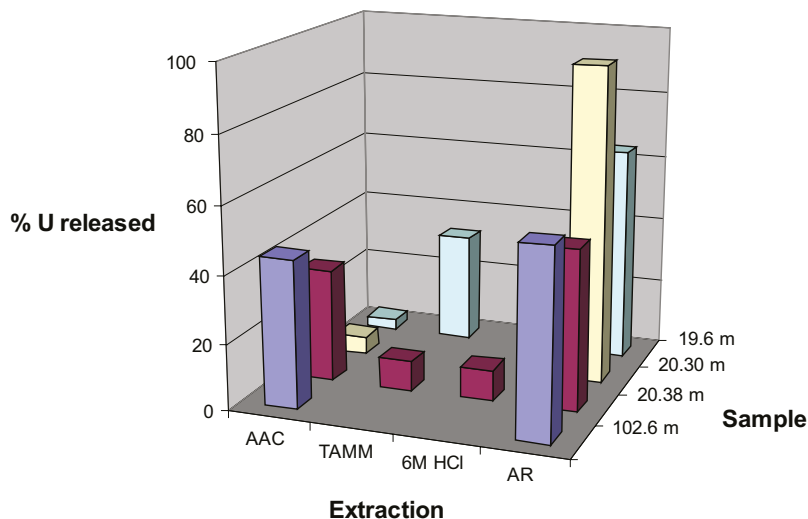

Figure 3-11. Distribution of uranium in sequentially extracted fracture coating samples from borehole KAS17.

Fractures lined with Fe-oxides are found in the Äspö bedrock and they are present as minor components nearly everywhere at the Earth’s surface. Their affinity for multivalent species is high but Fe-oxide uptake of lanthanides and actinides has not been studied to any great extent. Fe(II)-oxyhydroxides, known as “green rust”, form in Fe-bearing solutions under reducing conditions and are associated with the early stages of corrosion. Their uptake capacity during formation and transition to Fe(III)-oxides is essentially unknown at present. These minerals could be an important sink for radioactive species where Fe is abundant in the natural fractures or in materials brought into the repository. Iron itself can be an indicator of redox state. A very new topic of research, involving Fe-isotope fractionation, might give clues about redox conditions during Fe-mineral formation, or as a result of its inclusion in other secondary fracture minerals.

There are three questions relevant for radioactive waste disposal in fractured granite:

- How extensive is the capacity for Fe(III)-oxides, in fracture linings, to take up and retain radionuclides or other toxicants from solutions, and what happens during transformation of the oxides to more stable phases?
- What capacity do the reduced Fe(II)-oxides have for uptake and retention?
- Does the suite of trace components and isotopes measured in minerals from fracture linings provide information about conditions of the groundwater that passed through them in the past?

These questions can be rephrased more specifically for direct application to problems for Swedish waste disposal, such as:

- Can more detailed information about the uptake of higher valent elements such as Eu^{3+} provide a model for actinide behaviour and Cr^{3+} as a palaeo-redox indicator?
- Can stable Fe-isotopes from Fe-oxides or from other minerals tell anything about solution conditions during genesis?
- What is the uptake and retention capacity of green rust under solution conditions relevant for Äspö?
- Is it possible to find evidence to support or dispute the hypothesis that, at the time of glacier retreat, oxidising water might have penetrated to or below the depth of the planned final repository?
- How might secondary Fe-minerals affect the migration of radionuclides released from a repository?

Objectives and experimental concept

The basic idea of the project is to examine Fe-oxide fracture linings in order to explore suitable palaeo-indicators and their formation conditions. For example, potential low temperature oxidation under a deglaciation is expected to result in the removal of Fe(II)-bearing phases with precipitation of Fe(III)-oxides. At the same time, knowledge about the behaviour of trace component uptake can be obtained from natural material as well as studies in the laboratory under controlled conditions.

A glove-box set-up, where Atomic Force Microscopy is possible in situ, was used to investigate green rust under a stable atmosphere at reducing conditions. More possibilities for extracting chemical information from the secondary Fe-oxides were tested and the merits of stable Fe- and O-isotope fractionation as well as Mössbauer (MS) and energy dispersive X-ray (EDS) spectroscopy were examined. Scanning electron micrographs of the secondary Fe-oxide phases were obtained on a JEOL 6320F scanning electron microscope using secondary electrons.

Results

This continuation phase of the project was based on a study of Fe-oxides currently present in the water-bearing fractures from investigated sites at Äspö, Oskarshamn and Laxemar. These Fe-oxides were investigated to test if they could provide information about the redox conditions during their formation, which in turn could indicate any deep introduction of oxidised waters as a result of present and/or past meteoric recharge, or resulting from past glaciation or de-glaciation events in this part of Sweden. Introduction of oxidising waters to repository depths may be detrimental to the long-term integrity of the engineered barrier system (e.g. canister corrosion; bentonite stability, radionuclide transport).

In 2007, a new method to determine the penetration depth of oxidising waters using Fe-oxides as proxies was presented and a limited set of samples were investigated /Dideriksen et al. 2007/. In 2008 this method was applied to a larger sample suite (28 samples) taken from the upper approximately 110 m of drillcore material from the Laxemar site /Dideriksen et al. 2009/. From the various sites studied, three types of natural Fe-oxides have been identified:

Type I: Hematite with a large particle size and little variation in Fe isotope composition, occurring at depths ranging from the surface to 800 m (Figure 3-12).

Type II: Crystalline Fe-oxides (goethite, magnetite, hematite with smaller particle sizes) occurring at depths down to 110 m below surface (Figure 3-13).

Type III: X-ray identified amorphous, nanometre size Fe-oxides occurring at depths down to 50 m below surface.

The Fe isotope composition of Type I samples is hydrothermal in origin and varies little, whilst Type II and III samples vary significantly, consistent with low temperature formation. The X-ray amorphous nature of the Type III Fe-oxides indicates that they have formed during recent iron cycling. On the other hand, Type II Fe-oxides consist of well-formed crystals. These are larger than Type III as a result of recrystallisation and Ostwald ripening, suggesting that they are mature and record earlier oxidation events. Thus, in general, the studies indicate that the fractures of the upper 50 m are currently experiencing episodes of oxidation (i.e. meteoric recharge), whereas earlier events of low temperature oxidation have occurred down to depths of 110 m below surface for brief periods (i.e. meteoric recharge and/or glacial melt waters).

A goethite-bearing sample from about 90 m depth and adjacent silicates was analysed for oxygen isotopes to test a possible relationship to glacial waters. Although the analysis was complicated by the presence of silicates in the goethite-bearing material, the calculated isotope composition of the goethite formation water was $\delta^{18}\text{O} = -6.0\text{‰}$ to -4.9‰ V SMOW. These values indicate that the goethite formed from meteoric water or from older seawater suggesting that oxidising waters may penetrate to depths of about 90 m without glacial influence. In the samples studied, no evidence has been found of natural, low-temperature formation of Fe-oxides below 110 m.

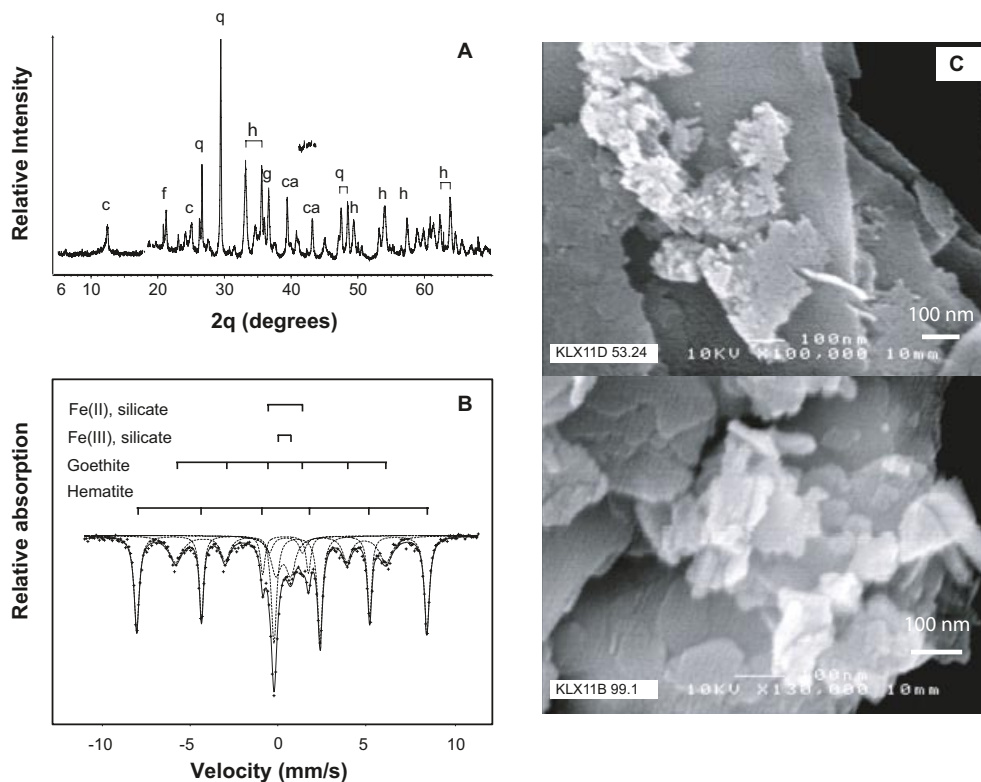

Figure 3-12. Examples of results for hematite-bearing samples. A) XRD pattern from sample KLX11D: 109.03 m displaying diffraction maxima representing goethite (g), hematite (h), chlorite (c), quartz (q), feldspar (f) and calcite (ca). B) Mössbauer spectrum showing absorption from goethite, hematite and Fe in silicates. C) Scanning electron images, showing aggregates of particles. Images of larger particles (sample KLX11B:99.1 m) have the plate-like morphology often associated with hematite. Also visible are larger sheets of chlorite.

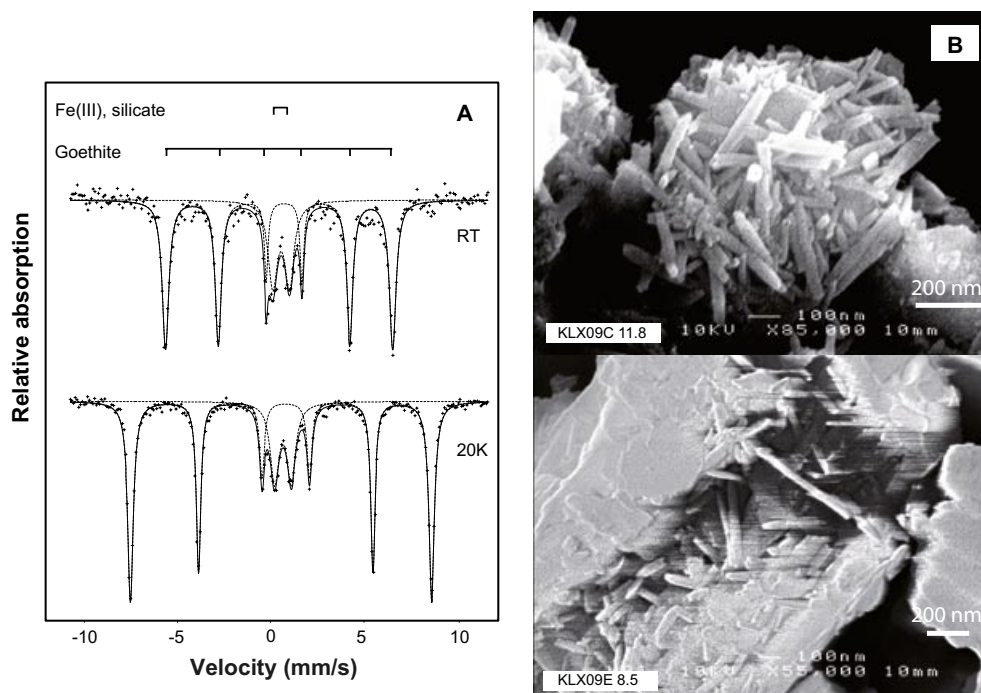

Figure 3-13. Example of results for goethite-bearing samples. A) Mössbauer spectra of sample KLX09E:8.5 m showing parameters close to bulk goethite. B) Scanning electron images display acicular particles, with a morphology typical of goethite, having widths of ~40 nm and lengths of ~200 nm. Larger sheets of phyllosilicates are also visible.

3.9 Swiw-tests with Synthetic Groundwater

Background and objectives

The Single Well Injection Withdrawal (Swiw) tests with synthetic groundwater constitute a complement to performed tests and studies on the processes governing retention, e.g. the True-1 and the True Block Scale experiments as well as Swiw tests performed within the SKB site investigation programme. This project aims to deepen the understanding for the processes governing retention. Swiw tests with synthetic groundwater facilitate the study of diffusion in stagnant water zones and in the rock matrix. It also facilitates the possibility to test the concept of measuring fracture aperture with the radon concept.

The general objective of the project is to increase the understanding of the dominating retention processes and to obtain new information on fracture aperture and diffusion.

Experimental concept

The basic idea is to perform Swiw tests with synthetic groundwater with a somewhat altered composition, e.g. replacement of chloride, sodium and calcium with nitrate, lithium and magnesium, compared to the natural groundwater at the site. Sorbing as well as non-sorbing tracers may be added during the injection phase of the tests. In the withdrawal phase of the tests the contents of the “natural” tracers (chloride, sodium and calcium) as well as the added tracers in the pumping water is monitored. The combination of tracers, both added and natural, may then provide desired information of diffusion, for example if the diffusion is dominated by the rock matrix or stagnant zones.

Results

The activity within the project was rather low during 2008, partly due to a heavy engagement in the SKB site investigation programme by the project members. Additionally, the test site originally intended to be used for Swiw-test with Synthetic Groundwater, the True Block Scale site, will be occupied by the project Sealing of Tunnel at Great Depth until June 2009.

The major achievements during year 2008 were the finalisation of the feasibility study /Nordqvist et al. 2008/ and a meeting where the results of the feasibility study and the continuation of the project was discussed. A key issue identified for the project is the site that should be used for the field tests. Three general candidates were identified; True Block Scale, other test site in the tunnel and test site at the surface. The original plan for 2008 was to decide a test site for the project. However, since the True Block Scale site still is a possible test site, no such decision was made during 2008. At the meeting it was decided that a project decision and a project plan should be produced. The preliminary order of activities in the project plan should be; site selection, investigations of the selected site, Swiw pre-tests, Swiw main tests and finally evaluation and reporting of the tests. The project plan and project decision were not finalised during 2008.

3.10 Task Force on Modelling of Groundwater Flow and Transport of Solutes

Background

The work within Äspö Task Force on modelling of groundwater flow and transport of solutes constitutes an important part of the international co-operation within the Äspö HRL. The group was initiated by SKB in 1992. A Task Force delegate represents each participating organisation and the modelling work is performed by modelling groups. The Task Force meets regularly about once to twice a year.

Different experiments at the Äspö HRL are utilised to support the modelling tasks. To date modelling issues and their status are as follow:

Task 1: Long term pumping and tracer experiments (completed).

Task 2: Scooping calculations for some of the planned detailed scale experiments at the Äspö site (completed).

- Task 3: The hydraulic impact of the Äspö tunnel excavation (completed).
- Task 4: The Tracer Retention and Understanding Experiment, 1st stage (completed).
- Task 5: Coupling between hydrochemistry and hydrogeology (completed).
- Task 6: Performance assessment modelling using site characterisation data (completed).
- Task 7: Long-term pumping experiment in Olkiluoto, Finland (ongoing).

Objectives

The Äspö Task Force is a forum for the organisations supporting the Äspö HRL project to interact in the area of conceptual and numerical modelling of groundwater flow and solute transport in fractured rock. In particular, the Task Force shall propose, review, evaluate, and contribute to such work in the project. The Task Force shall interact with the principal investigators responsible for carrying out experimental and modelling work for Äspö HRL of particular interest for the members of the Task Force.

Much emphasis is put on building of confidence in the approaches and methods in use for modelling of groundwater flow and migration in order to demonstrate their use for performance and safety assessments.

Task 6 was initiated in 2001 and is now completed. Task 6 does not contain experimental work but it uses experimental results of the former Task 4 and True Block Scale project. Task 4 included a series of tracer tests performed in a single feature over transport distances of about 5 m using simple flow geometry and both conservative and sorbing tracers. In True Block Scale, a series of tracer tests was performed in a fracture network over tens of metre distances. The main objectives of Task 6 are to:

- Assess simplifications used in performance assessment (PA) models.
- Assess the constraining power of tracer experiments for PA models.
- Provide input for site characterisations programme from PA perspective.
- Understand the site-specific flow and transport at different scales using site characterisation models.

Task 7 was presented at the 19th International Task Force meeting in Finland, 2004. Hydraulic responses during construction of a final repository are of great interest because they may provide information for characterisation of hydraulic properties of the bedrock and for estimation of possible hydraulic disturbances caused by the construction. Task 7 will focus on the underground facility Onkalo at the Olkiluoto site in Finland, and is aimed at simulating the hydraulic responses detected during a long-term pumping test carried out in borehole KR24. In addition, Task 7 is addressing the usage of Posiva Flow Log (PFL) data and issues related to open boreholes. During the project, one more objective has been added, and that is to address the reduction of uncertainty by using PFL data. In fact, the title of the task has been altered to “Reduction of Performance Assessment uncertainty through modelling of hydraulic tests at Olkiluoto, Finland”.

Results

Task 6 is completed, except for publishing of some papers. A summary of the outcome of Task 6 has been accepted for publishing in a scientific journal /Hodgkinson et al. 2009/. In addition, papers from four modelling groups have also been accepted by the same scientific journal and in conjunction with the summary paper. An essay describing the framework for all these papers is also accepted. Work on editorial modifications has been made for all the papers.

Task 7 is divided into several sub-tasks. Draft reports on sub-task 7A1–A5 have been updated based on review comments. An updated task description for the sub-task 7B and more data have been sent out to the modellers. A workshop for Task 7 was held in May where modelling approaches and plans for the future modelling were presented and discussed. The venue took place in Oxford. Preliminary results have been presented at the 24th Task Force meeting.

The 24th international Task Force meeting was held at Äspö in September. The presentations were mainly addressing modelling results on sub-task 7B. The discussions on the continuation of Task 7 and also the start up of Task 8 were constructive. Task 8 will be a joint effort with the Task Force on Engineered Barriers, and will be addressing the processes at the interface between the rock and the bentonite in deposition holes. The minutes of this venue have been distributed to the Task Force. Planning for the Task 7 and 8 Workshop in Lund, January 2009, has been on-going and the first notice of this meeting was distributed to the modellers in December.

The description and the status of the specific modelling tasks within Task 6 and 7 are given in Table 3-1. For more detailed information about performed work within the different tasks by the international organisations, see Sections 7.4 to 7.7.

Table 3-1. Task descriptions and status of the specific modelling sub-tasks.

6	Performance Assessment (PA) modelling using Site Characterisation (SC) data
6A	Model and reproduce selected True-1 tests with a PA model and/or a SC model to provide a common reference. – External review report /Hodgkinson and Black 2005/.
6B	Model selected PA cases at the True-1 site with new PA relevant (long term/base case) boundary conditions and temporal scales. This sub-task serves as means to understand the differences between the use of SC-type and PA-type models and the influence of various assumptions made for PA calculations for extrapolation in time. – External review report /Hodgkinson and Black 2005/.
6C	Develop semi-synthetic, fractured granite hydrostructural models. Two scales are supported (200 m block scale and 2,000 m site-scale). The models are developed based on data from the Prototype Repository, True Block Scale, True-1 and Fracture Characterisation and Classification project (FCC). – External review report /Black and Hodgkinson 2005/.
6D	This sub-task is similar to sub-task 6A and is using the synthetic structural model in addition to a 50 to 100 m scale True-Block Scale tracer experiment. – External review report /Hodgkinson 2007/.
6E	This sub-task extends the sub-task 6D transport calculations to a reference set of PA time scales and boundary conditions. – External review report /Hodgkinson 2007/.
6F	Sub-task 6F is a sensitivity study, which is proposed to address simple test cases, individual tasks to explore processes and to test model functionality. – External review report /Hodgkinson 2007/.
7	Reduction of Performance Assessment uncertainty through modelling of hydraulic tests at Olkiluoto, Finland.
7A	Long-term pumping experiment. (Final results of sub-task 7A1 and 7A2 are presented. Draft reports updated after review).
7A1	Hydrostructural model implementation.
7A2	Pathway simulation within fracture zones.
7A3	Conceptual modelling of PA relevant parameters from open hole pumping.
7A4	Quantification of compartmentalisation from open hole pumping tests and flow logging.
7A5	Quantification of transport resistance distributions along pathways.
7B	Sub-task 7B is addressing the same as sub-task 7A but in a smaller scale, i.e. rock block scale. Sub-task 7B is using sub-task 7A as boundary condition. (Preliminary results presented at Task Force meeting 24).
7C	Here focus is on deposition hole scale issues, resolving geomechanics, buffers, and hydraulic views of fractures.
7D	Tentatively sub-task 7D concerns integration on all scales.

4 Engineered barriers

4.1 General

To meet stage goal 4, to demonstrate technology for and function of important parts of the repository barrier system, work is performed at Äspö HRL. This implies translation of current scientific knowledge and state-of-the-art technology into engineering practice applicable in a future repository.

It is important that development, testing and demonstration of methods and procedures, as well as testing and demonstration of repository system performance, are conducted under realistic conditions and at appropriate scale. A number of large-scale field experiments and supporting activities are therefore conducted at Äspö HRL. The experiments focus on different aspects of engineering technology and performance testing, and will together form a major experimental programme. With respect to technology demonstration the important overall objectives of this programme are:

- To furnish methods, equipment and procedures required for excavation of tunnels and deposition holes, near-field characterisation, canister handling and deposition, backfilling, sealing and plugging tunnels, monitoring and also canister retrieval.
- To integrate these methods and procedures into a disposal sequence, that can be demonstrated to meet requirements of quality in relation to relevant standards, as well as practicality.

With respect to repository function, the objectives are to test and demonstrate the function of the engineered barriers as well as the function of the integrated repository system. During 2008, the ongoing experiments and projects within Engineered barriers have been:

- Prototype Repository.
- Long Term Test of Buffer Material.
- Alternative Buffer Materials.
- Backfill and Plug Test.
- Canister Retrieval Test.
- Temperature Buffer Test.
- KBS-3 Method with Horizontal Emplacement.
- Sealing of Tunnel at Great depth.
- Large Scale Gas Injection Test.
- In situ Corrosion Testing of Miniature Canisters.
- Cleaning and Sealing of Investigation Boreholes.
- Task Force on Engineered Barrier Systems.

4.2 Prototype Repository

Background

Many aspects of the KBS-3 repository concept have been tested in a number of in situ and laboratory tests. Models have been developed that are able to describe and predict the behaviour of both individual components of the repository, and the entire system. However, processes have not been studied in the complete sequence, as they will occur in connection to repository construction and operation. In addition, it is needed to demonstrate that it is possible to understand the processes that take place in the engineered barriers and the surrounding host rock.

The execution of the Prototype Repository is a dress rehearsal of the actions needed to construct a final repository from detailed characterisation to resaturation of deposition holes and tunnel backfill. The Prototype Repository provides a demonstration of the integrated function of the repository

and provides a full-scale reference for test of predictive models concerning individual components as well as the complete repository system. The Prototype Repository should demonstrate that the important processes that take place in the engineered barriers and the host rock are sufficiently well understood.

The installation of the Prototype Repository has been co-funded by the European Commission with SKB as co-ordinator. The EC-project started in September 2000 and ended in February 2004. The continuing operation of the Prototype Repository is funded by SKB.

Objectives

The main objectives for the Prototype Repository are to:

- Test and demonstrate the integrated function of the final repository components under realistic conditions in full-scale and to compare results with model predictions and assumptions.
- Develop, test and demonstrate appropriate engineering standards and quality assurance methods.
- Simulate appropriate parts of the repository design and construction processes.

The evolution of the Prototype Repository should be followed for a long time, possibly up to 20 years. This is made to provide long term experience on repository performance to be used in the evaluation that will be made after the initial operational stage in the real deep repository.

Experimental concept

The test is located in the innermost section of the TBM-tunnel at the –450 m level. The layout involves altogether six deposition holes, four in an inner section and two in an outer, see Figure 4-1. Canisters with dimension and weight according to the current plans for the final repository and with heaters to simulate the thermal energy output from the spent nuclear fuel have been positioned in the holes and surrounded by bentonite buffer. The deposition holes are placed with a centre distance of 6 m. This distance was evaluated considering the thermal diffusivity of the rock mass and the maximum acceptable surface temperature of the canister. The deposition tunnel is backfilled with a mixture of bentonite and crushed rock (30/70). A massive concrete plug, designed to withstand full water and swelling pressures, separates the test area from the open tunnel system and a second plug separates the two sections. This layout provides two more or less independent test sections.

The decision when to stop and decommission the test will be influenced by several factors including performance of monitoring instrumentation and results successively gained. It is envisaged that the outer test section will be decommissioned after approximately five years to obtain interim data on buffer and backfill performance. Instrumentation is used to monitor processes and evolution of properties in canister, buffer, backfill and near-field rock. Examples of processes that are studied include:

- Water uptake in buffer and backfill.
- Temperature distribution (canisters, buffer, backfill and rock).
- Displacement of canister.
- Swelling pressure and displacement in buffer and backfill.
- Stress and displacement in the near-field rock.
- Water pressure build up and pressure distribution in rock.
- Gas pressure in buffer and backfill.
- Chemical processes in rock, buffer and backfill.
- Bacterial growth and migration in buffer and backfill.

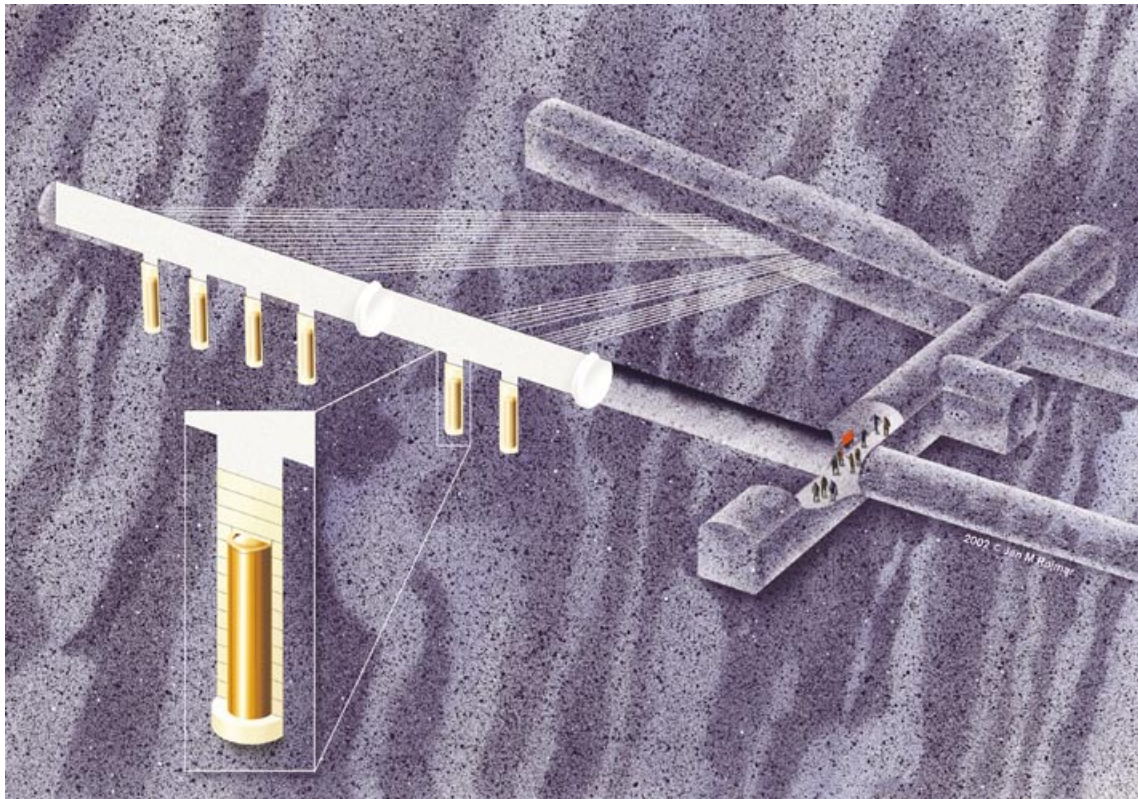

Figure 4-1. Schematic view of the layout of the Prototype Repository (not to scale).

Results

The installation of Section I was done during summer and autumn 2001. The heating of the canister in deposition hole 1 started at 17th September. This date is also marked as start date. The backfilling was finished in the end of November and the plug was cast at in the middle of December. The installation of Section II was done during spring and summer 2003. The heating of the canister in hole 5 started at 8th of May. This date is also marked as start date for Section II. The backfilling was finished at the end of June and the plug was cast in September. The interface between the rock and the outer plug was grouted at the beginning of October 2004.

At the beginning of November 2004 the drainage of the inner part of Section I and the drainage through the outer plug were closed. This affected the pressure (both total and pore pressure) in the backfill and the buffer in the two sections dramatically. Example of data from the measurements in the backfill of the total pressure is shown in Figure 4-2. The maximum pressures were recorded around 1st January 2004. At that date the heating in canister 2 failed. It was then decided to turn off the power to all of the six canisters. Four days later, also damages on canister 6 were observed. The drainage of the tunnel was then opened again. During the next week further investigations on the canisters were done. The measurements showed that the heaters in canister 2 were so damaged that no power could be applied to this canister. The power to the rest of the canisters was applied again on 15th of November 2004. The drainage of the tunnel was kept open. At the beginning of August 2005 another failure of canister 6 was observed. The power to this canister was switched off until beginning of October 2005 when the power was switched on again. During 2008 new problems were observed with the heaters in canister 6, resulting in that the power was reduced to 1,160 W. A data report covering the period 17th September 2001 up to 1st June 2008 is available /Goudarzi and Johannesson 2008/.

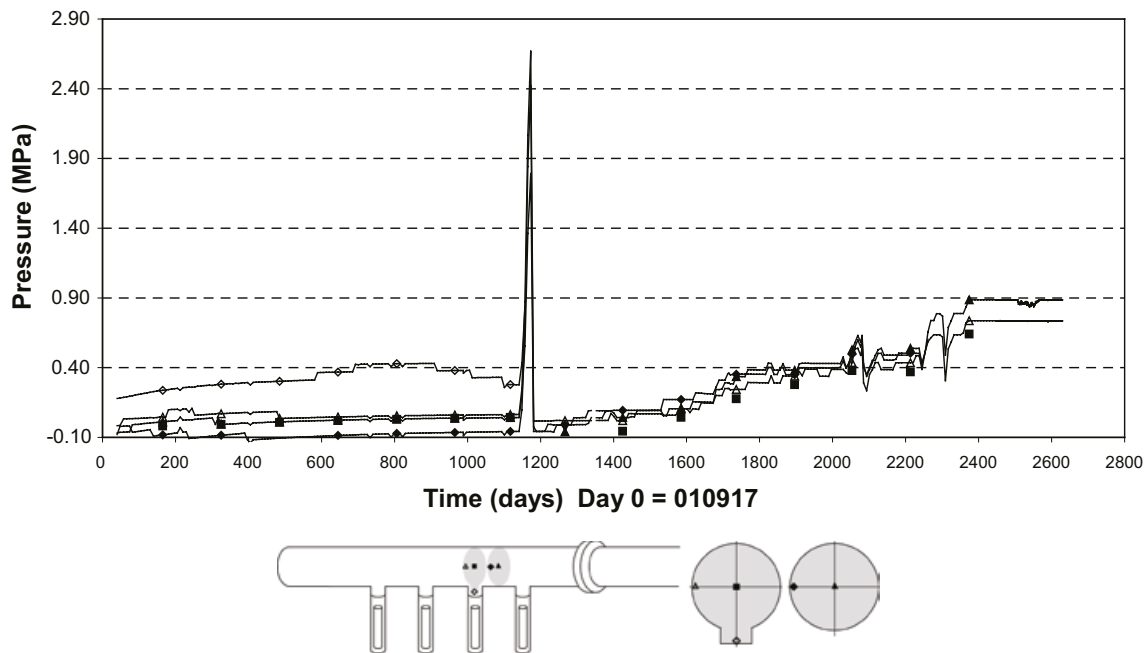

Figure 4-2. Examples of measured total pressure in the backfill around deposition hole 3 (17th September 2001 to 1st December 2008).

Measurements in rock, backfill and buffer

Altogether more than 1,000 transducers were installed in the rock, buffer and backfill /Collin and Börgesson 2002, Börgesson and Sandén 2002, Rhén et al. 2003/. The transducers measure the temperature, the pore pressure and the total pressure in different part of the test area. The water saturation process is recorded by measuring the relative humidity in the pore system of the backfill and the buffer, which can be converted to total suction.

Furthermore transducers were installed for recording the displacement of the canisters in deposition hole 3 and 6 /Barcena and Garcai-Sineriz 2001/. In addition resistivity measurements are made in the buffer and the backfill /Rothfuchs et al. 2003/. The outcome from these measurements is profiles of the resistivity which can be interpreted to water ratios of the backfill and the buffer. Most transducers are still working and are giving reliable data.

Transducers for measuring the stresses and the strains in the rock around the deposition holes in Section II have also been installed /Bono and Röshoff 2003/. The purpose with these measurements is to monitor the stress and strain caused by the heating of the rock from the canisters.

A large programme for measuring the water pressure in the rock close to the tunnel is also ongoing /Rhén et al. 2003/. The measurements are made in boreholes which are divided into sections with packers. In connection with this work a new packer was developed that is not dependent of an external pressure to seal off a borehole section. The sealing is made by highly compacted bentonite with rubber coverage. Tests for measuring the hydraulic conductivity of the rock are also made with the use of the drilled holes. This work has been made in test campaigns since the installation. The latest date (test campaign 9) has recently been published /Forsmark 2008/. Results from tracer dilution tests, performed during 2007, in order to evaluate the groundwater flow in the rock are published in /Norman and Andersson 2007/.

An ultrasonic monitoring system has been installed around deposition hole 6. The system consists of twenty-four ultrasonic transducers installed into four instrumentation boreholes. The ultrasonic monitoring has been conducted since 1999 and the latest measurements were published in two reports during 2007 /Haycox and Pettitt 2006, Zolezzi et al. 2007/ and a third report will soon be printed. Two techniques are utilised here to investigate the processes occurring within the rock mass around the deposition hole: ultrasonic survey and acoustic emission (AE). Ultrasonic surveys are used to “actively” examine the rock. Amplitude and velocity changes on the ray paths can then be interpreted

in terms of changes in the material properties of the rock. AE monitoring is a “passive” technique similar to earthquake monitoring but on a much smaller distance scale (source dimensions of millimetres). AE’s occur on fractures in the rock when they are created or when they move. Results from AE monitoring during the heating phase of the Prototype Repository are shown in Figure 4-3.

Equipment for taking gas and water samples both in buffer and backfill have been installed /Puigdomenech and Sandén 2001/. A report where analyses of microorganisms, gases and chemistry in buffer and backfill during 2004–2007 are described has been published /Eriksson 2008/. Examples of data from this work are shown in Figure 4-4 where the analyses of the gas samples taken at three different occasions from the top of the deposition holes 5 and 6 are plotted.

Recording of THM processes

The saturation of the buffer in the deposition holes

The Prototype tunnel was drained until 1st November 2004. This affects the water uptake both in the buffer and in the backfill. The saturation of the buffer has reached different levels in the six deposition holes due to variation in the access to water.

Many of the sensors for measuring total pressure, placed at the canister level in deposition hole 1 are recording high pressures. Also some pore pressure sensors placed at the same level are measuring high pressures. The installed sensors for measuring relative humidity (RH) placed at mid height of the canister have stopped giving reliable values after they have reached 100% RH. This is indicating that the buffer around the canister is close to saturation. Corresponding measurements in the buffer above and under the canister are indicating that these parts of the buffer are not saturated.

The measurements of the total pressure, pore pressure and relative humidity in the buffer in deposition hole 3 are indicating that the buffer is not saturated.

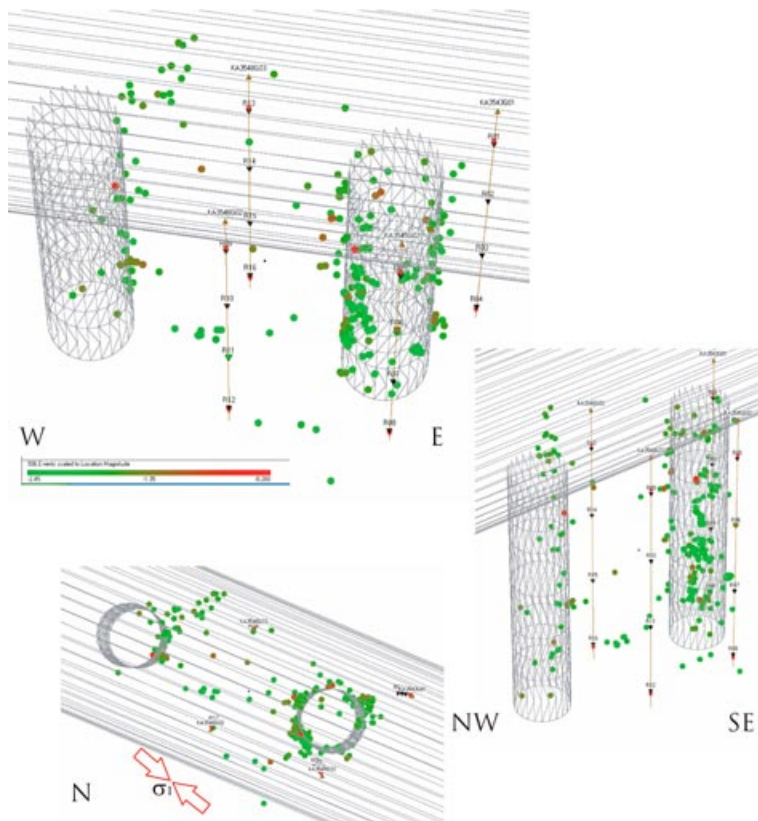

Figure 4-3. Projections of all acoustic emissions during the heating phase (20th March 2003 to 31st March 2007). Events are scaled to location magnitude /Zolezzi et al. 2007/.

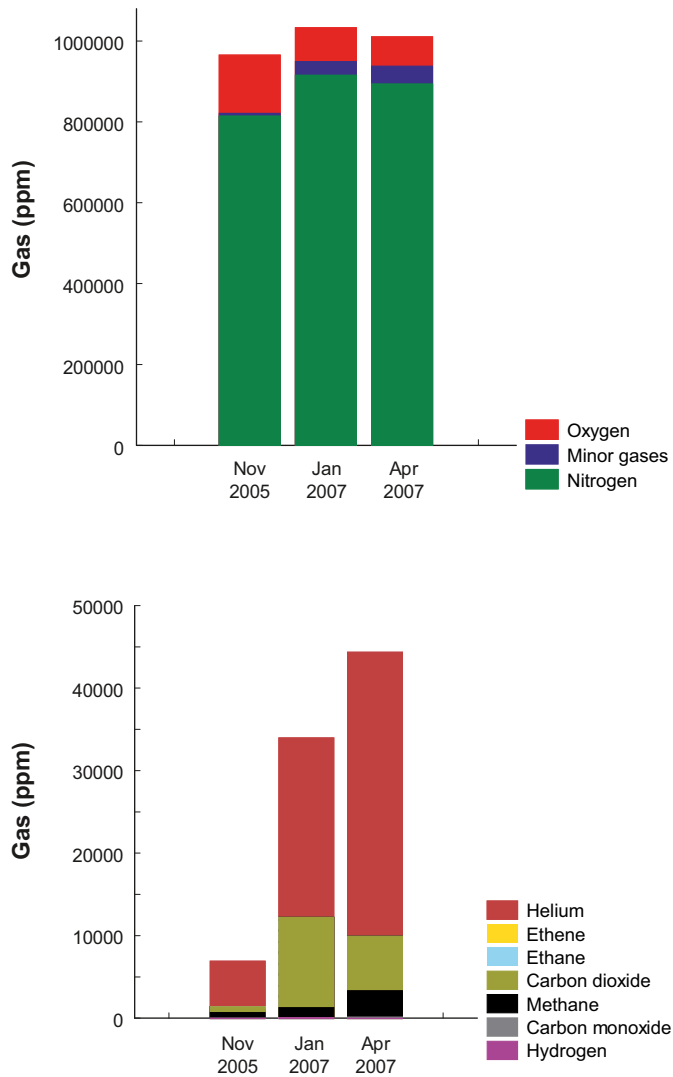

Figure 4-4. The mean composition of major and minor gases in the KB513-614 group at the different sampling occasions during 2005–2007. The gas content is given in ppm of the total amount of extracted gas /Eriksson 2008/.

The saturation of the buffer in deposition hole 5 indicated by RH-sensors and total pressure sensors is complex. Some total pressure sensors are measuring rather high pressures (higher than 2.5 MPa) while others measure very low pressures. The sensors giving high pressures are placed both in block C1 and rings R5 and R10 (the uppermost ring). There are also some RH-sensors which are measuring relative humidity of ~100%, indicating a high saturation of the buffer. In other parts of the buffer most of the sensors (both RH-sensors and total pressure sensors) indicate a slow wetting of the buffer with time. Although the sensors reacted rather strongly just before and after the power was switched on and off at the beginning of December 2004, the saturation rate indicated by the sensors is not changed radically over time.

The saturation of the buffer in deposition hole 6 was affected by the fast increase in pressure when the drainage of the tunnel was closed, indicated by both RH-sensors and total pressure sensors. The total pressure was also affected when the power was switched off again at the beginning of September 2005. The drop in total pressure was very large and rapid and the pressure started to increase before the power to the canister was switched on again. When the power was switched on pressure increased very fast to the same level as before the power was switched off. This course of events is indicating that the change in total pressure is an affect of the changes in water volume in the bentonite caused by variation in temperature. At present, several total pressure sensors placed in the buffer below the canister lid are measuring high total pressures, indicating a high degree of saturation while the sensors placed above the canister are measuring lower pressures, indicating a lower degree of saturation.

Hydration of the backfill

The pore pressure in the backfill in Section I increased fast from a low level when the drainage of the tunnel was closed, see Figure 4-5. This affected the rate in which the backfill was saturated measured both with soil psychrometers and with resistivity measurements made by Gesellschaft für Anlagen- und Reaktorsicherheit (GRS) mbH. After the drainage was reopened the pore pressure stabilised on the same level as before it was close. In Figure 4-5 results from measurements of suction in the backfill of Section I over deposition hole 1 are shown. The measurements are made with soil psychrometers. The curves indicate as expected a faster saturation of the backfill close to the roof and the walls of the tunnel while very slow changes in suction over time is recorded by transducers placed in the centre of the tunnel. This is valid up to the time when the drainage of the tunnel was closed. The sensors, which still gave reliable values, indicated a faster hydration after this event. However, after the reopening of the drainage most of the sensors, which still gave reliable data, indicated similar hydration rate as before the closing of the drainage. When a packer placed in a borehole in Section I was broken (at the middle of April 2006) the pressure in the backfill (both total pressure and pore pressure) increased with about 300 kPa, see Figure 4-5. The increase in pressure affected also the measured suction values (measured with soil psychrometers). Six of the sensors measured a decrease in suction of about 500 kPa due to the broken packer. At the beginning of April 2007 the work with the new Tass-tunnel nearby the Prototype Repository started. This work has affected the pore pressure and the saturation measured with the soil psychrometers since then, see Figure 4-5.

The pore pressure, measured both with total and pore pressure transducers placed in the backfill in Section II, increased also fast from a low level when the drainage of the tunnel was closed, see Figure 4-6. This affected the rate in which the backfill was saturated measured both with soil psychrometers and with resistivity measurements in the backfill. After the drainage was reopened again the pore pressure stabilised on a higher level than before the drainage was closed. Most of the installed soil psychrometers measure very low suction values after the closing/opening of the drainage which indicates that the backfill is close to fully saturated. All of the installed soil psychrometers have stopped giving reliable values due to high degree of saturation in the backfill. The pore pressure in the backfill continued to increase although the drainage was kept open. The measurement of the pore pressure was very much affected by the work with the new Tass-tunnel. An increase of the pore pressure of about 400 kPa was measured when the excavation work started. The pore pressure is continuing to increase.

Modelling of THM processes

The model used in the predictions and evaluations of the various processes in the buffer and backfill in Prototype Repository has been described in detail in /Pusch 2001/ and predictive modelling has been reported /Pusch and Svemar 2003/. The following is a brief summary of the major features of the models used for predicting the THM evolution:

- Thermal evolution in the buffer, backfill and near-field rock.
- Hydration of the buffer and backfill.
- Build-up of swelling pressure in the buffer and backfill.

The THM modelling has been made with CodeBright at Clay Technology. The work has been made in steps, where the first step was to make a 3D thermal model of the Prototype Repository. The 3D thermal analysis has the following main objectives:

- Find relevant time-dependent thermal boundary conditions for local THM models of the individual deposition holes.
- Investigate how well the measured rock temperatures can be reproduced assuming one global and constant value of the rock heat conductivity.
- Check the influence of the backfill thermal properties on the overall thermal development around canister mid-height, i.e. the region where maximum temperature is expected.
- Explore the effect of the open ventilated tunnel.

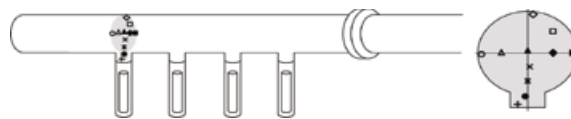
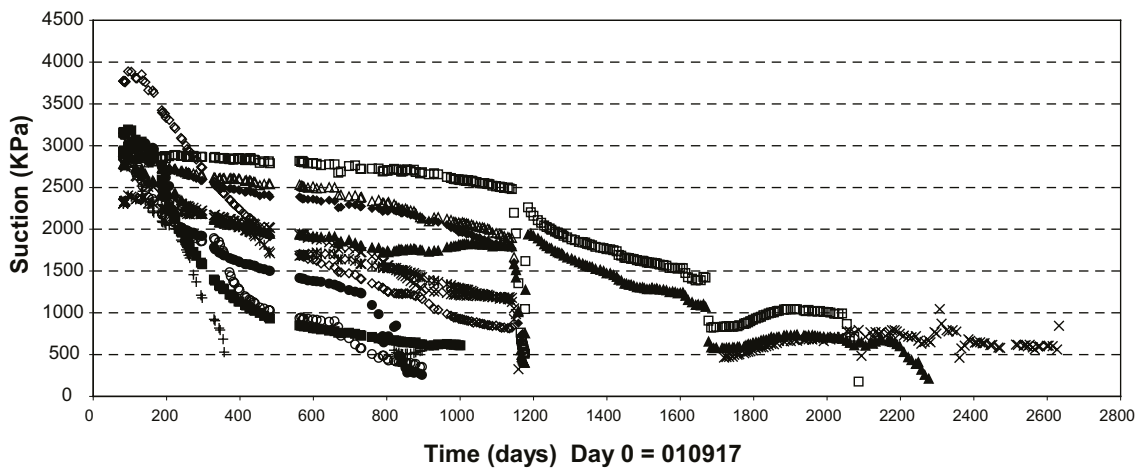
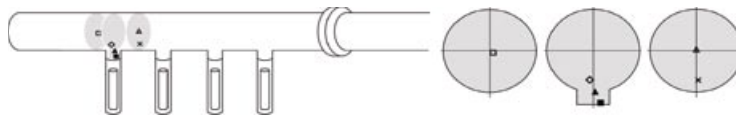
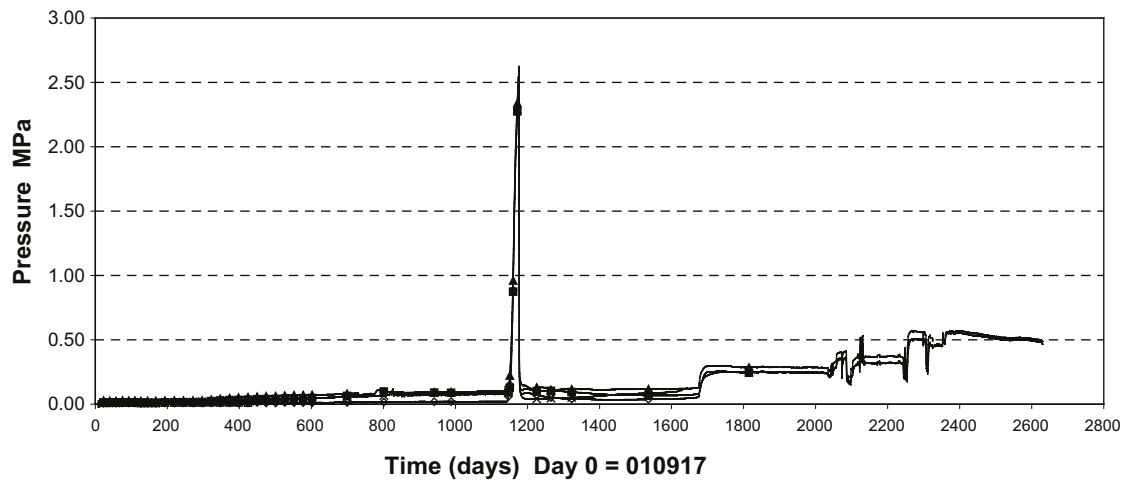

Figure 4-5. Examples of pore pressure and suction measured in the backfill in Section I above deposition hole 1 (17th September 2001 to 1st December 2008).

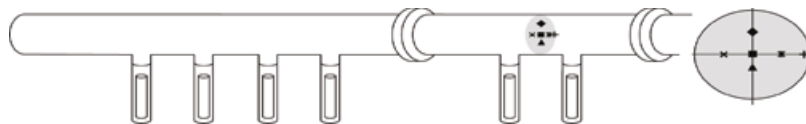
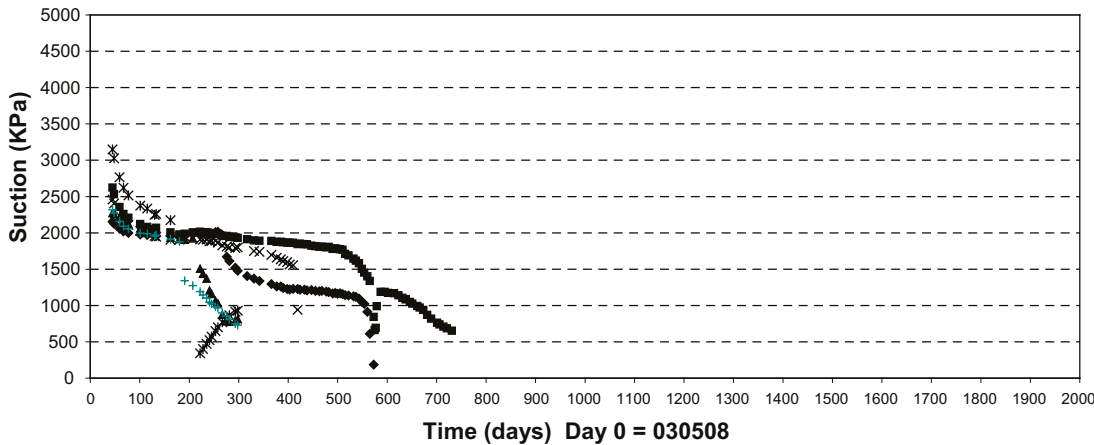
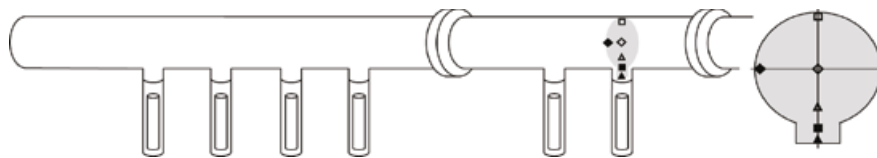
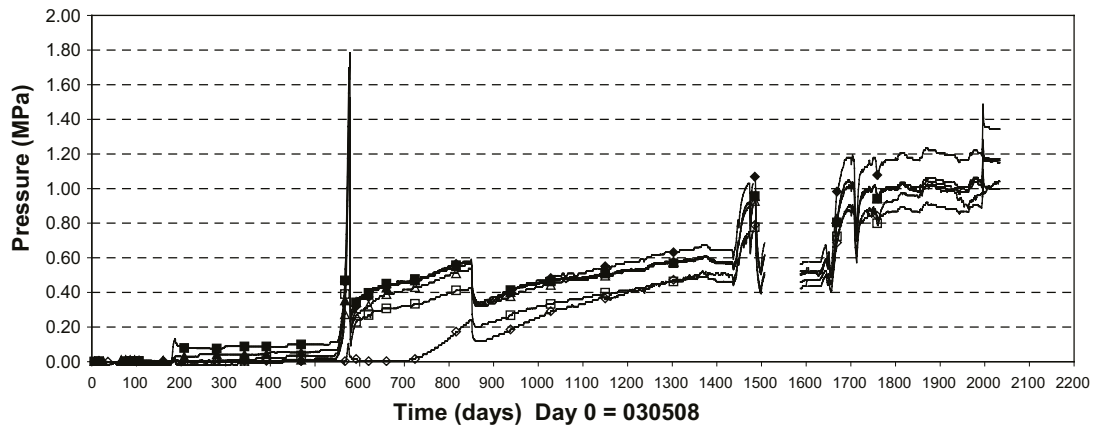

Figure 4-6. Examples of pore pressure and suction measured in the backfill in Section II close to deposition hole 6 (8th May 2003 to 1st December 2008).

This work has been published in a report /Kristensson and Hökmark 2007/. Examples of results from the analyses are shown in Figure 4-7 where the calculated temperatures in the rock at mid height of the canister near deposition hole 5 are compared with measured temperatures, both along the tunnel axis (upper part of the figure) and 90° off the tunnel axis.

The thermal 3D model will be further developed to incorporate also mechanical processes in the rock. The obtained TM 3D model may be used for evaluation of the thermo-induced spalling

The second step in the modelling work was to model the water uptake of the buffer with the use of a 1D model. In this work the focus was aimed at the engineered buffer system between the canister and the hosting rock wall. There are three different sections between the canister and rock wall. The main part constitutes of bentonite powder compressed into blocks. There is a slot between the blocks and the rock wall that is filled with bentonite pellets. There is also a slot between the canister and bentonite blocks that is open, see Figure 4-8.

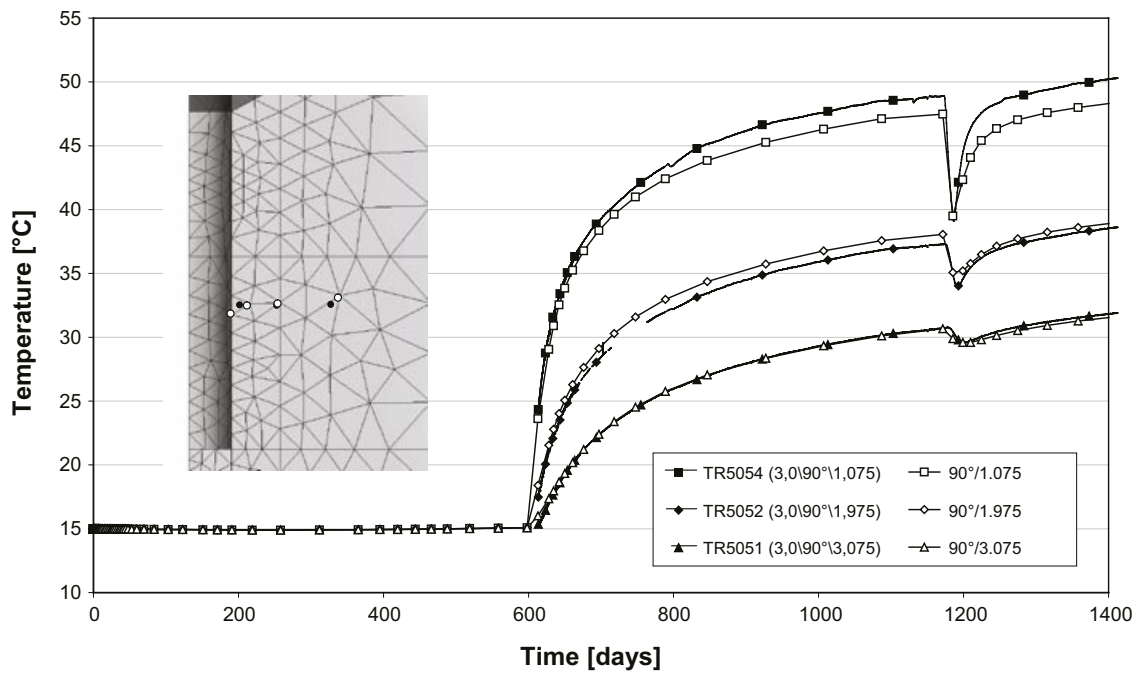
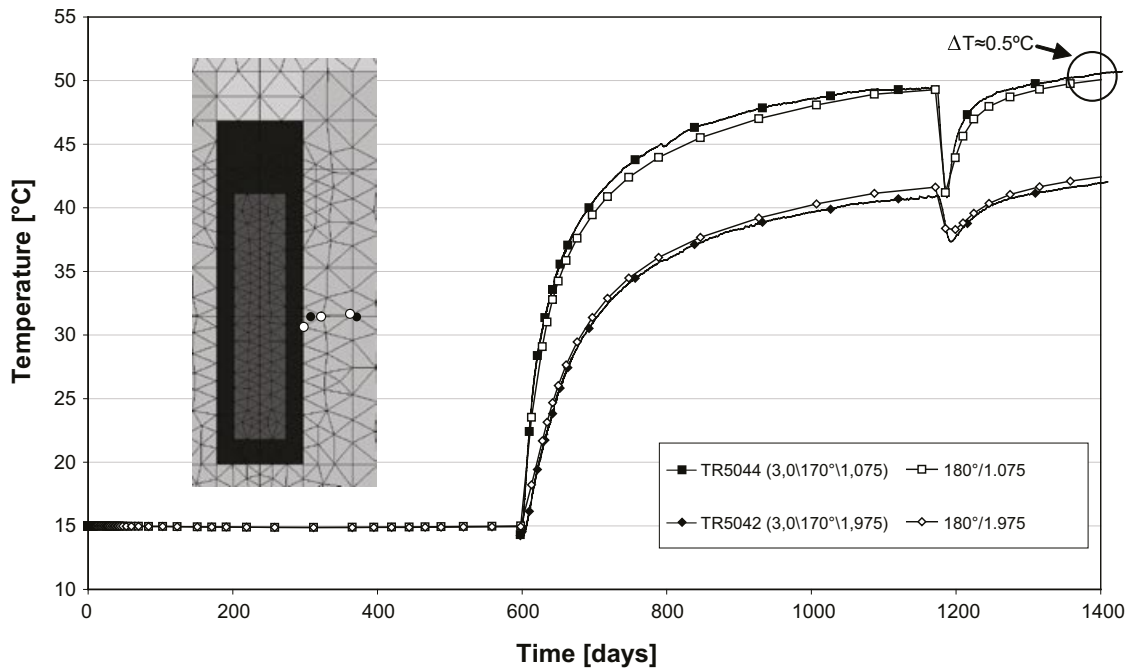

Figure 4-7. Rock temperatures close to hole 5. Comparison between measured (white dots) and calculated (black dots) temperatures. Upper figure: Positions along tunnel axis. Lower figure: Positions 90° off axis.

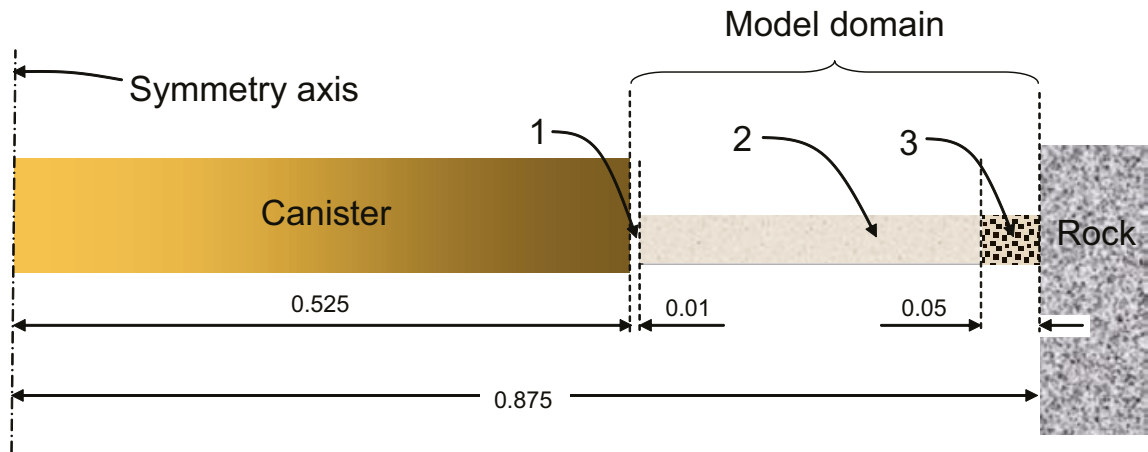

Figure 4-8. 1D model geometry: (1) open slot between canister and bentonite blocks, (2) bentonite blocks and (3) slot between bentonite blocks and rock (filled with bentonite pellets).

The main topics of the investigation were the water saturation process and homogenisation in the buffer. Thermal, hydrologic and mechanical conditions and processes are considered in the numerical study. This study also serves as a general investigation of the usefulness of the numerical tool, CodeBright, in this field of application.

An example of data from the calculations is shown in Figure 4-9 where the calculated total pressures (made for different assumptions) are compared with the measured pressure (solid thick line) as function of time from the start of the test. This work will soon be published in a report. Next step is to develop a THM model of an entire deposition hole. Heterogenic wetting may be investigated using such a model.

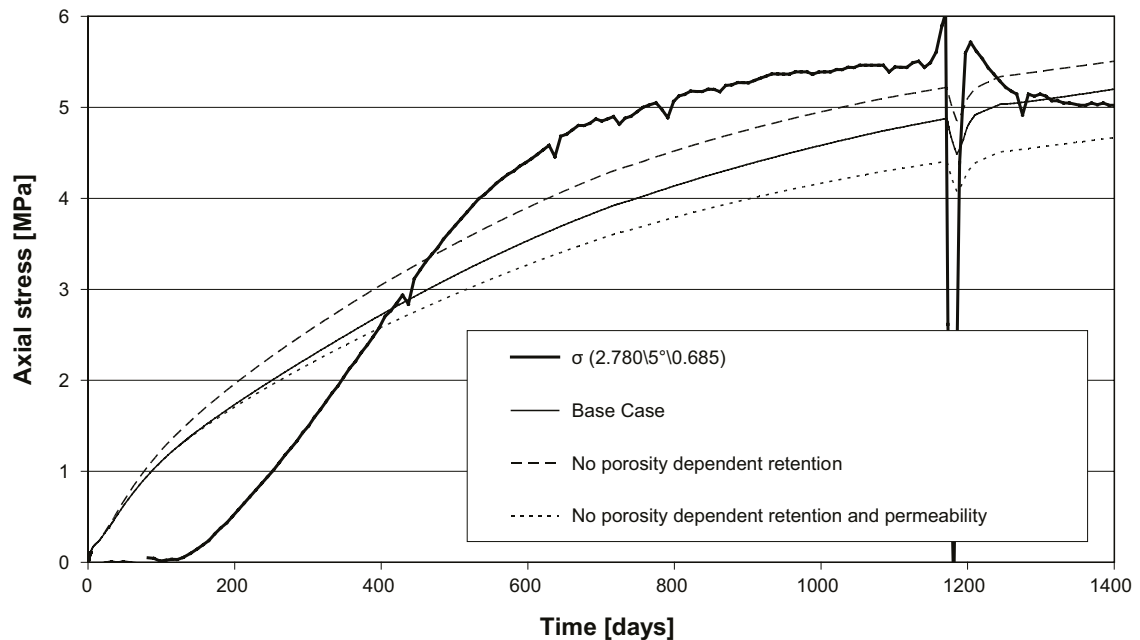

Figure 4-9. Measured (σ 2.780/5°/0.685) and calculated (THM1) axial stress history in the buffer in deposition hole 1 ($r=0.685$ m).

4.3 Long Term Test of Buffer Material

Background

Bentonite clay has been proposed as buffer material in several concepts for HLW repositories. In the Swedish KBS-3 concept the demands on the bentonite buffer are to serve as a mechanical support for the canister, reduce the effects on the canister of a possible rock displacement, and minimise water flow over the deposition holes.

The decaying power from the spent fuel in the canisters will give rise to a thermal gradient over the bentonite buffer by which original water will be redistributed parallel to an uptake of water from the surrounding rock. A number of laboratory test series, made by different research groups, have resulted in various buffer alterations models. According to these models no significant alteration of the buffer is expected to take place at the prevailing physico-chemical conditions in a KBS-3 repository, neither during nor after water saturation. The models may to a certain degree be validated in long term field tests. Former large-scale field tests in Sweden, Canada, Switzerland and Japan have in some respects deviated from possible KBS-3 repository conditions and the testing periods have generally been dominated by initial processes, i.e. water uptake and temperature increase.

Objectives

The present test series within the project Long Term Test of Buffer Material (Lot) aims at validating models and hypotheses concerning the evolution of bentonite buffer properties. In addition, related processes regarding microbiology, radionuclide transport, copper corrosion and gas transport under conditions similar to those expected in a KBS-3 repository are studied. The expression “long term” refers to a time span long enough to study the buffer performance at full water saturation, but obviously not “long term” compared to the lifetime of a repository. The objectives may be summarised in the following items:

- Collect data for validation of models concerning buffer performance under quasi-steady state conditions after water saturation, e.g. swelling pressure, cation exchange capacity and hydraulic conductivity.
- Check of existing models on buffer-degrading processes, e.g. illitisation and salt enrichment.
- Collect data concerning survival, activity and migration of bacteria in the buffer.
- Check of calculation results concerning copper corrosion and information regarding type of corrosion.
- Check existing models for diffusive transport of cations.
- Collect information, which may facilitate the realisation of the full-scale test series, with respect to clay preparation, instrumentation, data handling and evaluation.

Experimental concept

The testing principle for all tests is to emplace parcels containing heater, central tube, pre-compacted clay buffer, instruments and parameter controlling equipment in vertical boreholes with a diameter of 300 mm and a depth of around 4 m, see Figure 4-10. The test series concern realistic repository conditions except for the scale and the controlled adverse conditions in four tests, see Table 4-1.

Table 4-1. Buffer material test series.

Type	No.	max T (°C)	Controlled parameter	Time (years)	Remark
A	1	130	T, [K ⁺], pH, am	1	Reported
A	0	120–150	T, [K ⁺], pH, am	1	Reported
A	2	120–150	T, [K ⁺], pH, am	5	Report on review
A	3	120–150	T	>>5	Ongoing
S	1	90	T	1	Reported
S	2	90	T	5	Ongoing
S	3	90	T	>>5	Ongoing

A= adverse conditions, S= standard conditions, T= temperature, [K⁺]= potassium concentration, pH= high pH from cement, am= accessory minerals added.

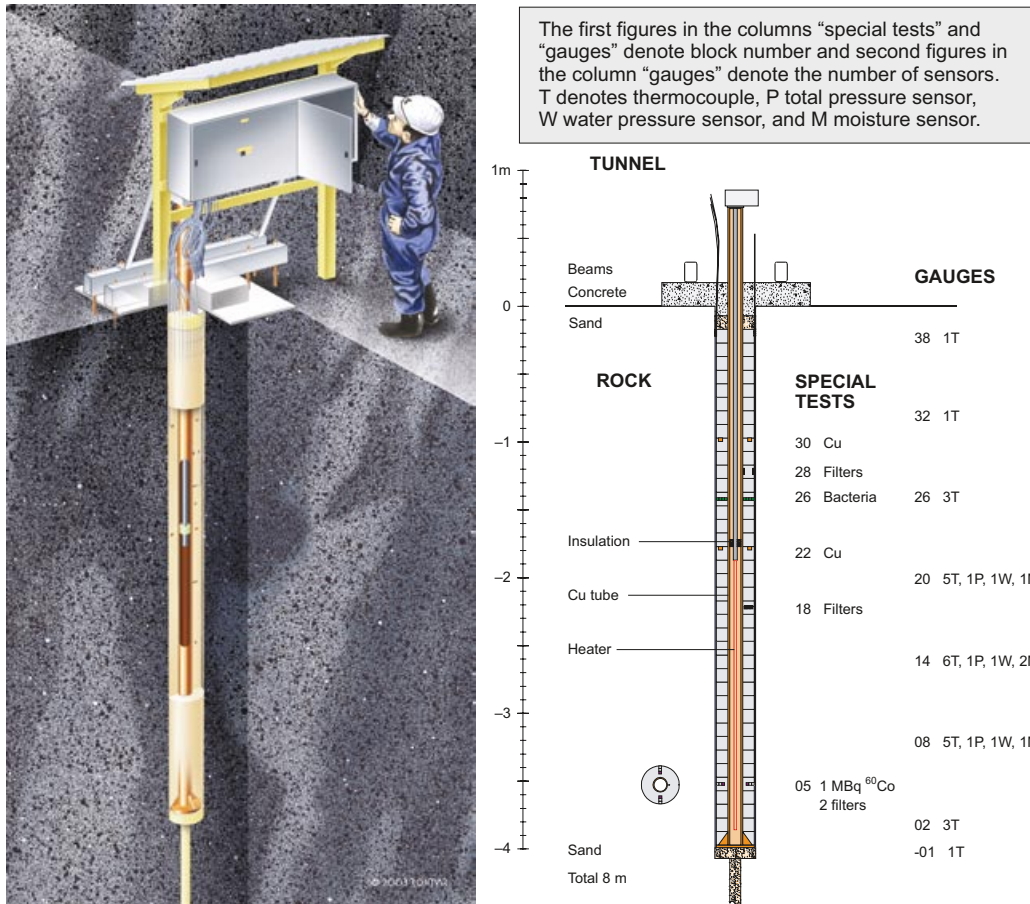

Figure 4-10. Illustration of the experimental set-up in the Long Term Test of Buffer Material (left) and a cross-section view of one S-type parcel (right).

Adverse conditions in this context refer to high temperatures, high temperature gradients over the buffer, and additional accessory minerals leading to for example high pH and high potassium concentration in clay pore water. The central copper tubes are equipped with heaters in order to simulate the decay power from spent nuclear fuel. The heater effect are regulated or kept constant at values calculated to give a maximum clay temperature of 90°C in the standard condition tests and in the range of 120 to 150°C in the adverse condition tests.

Each parcel contains 25 thermocouples, 3 total pressure gauges, 3 water pressure gauges, 4 relative humidity sensors, 7 filter tubes, and 12 water sampling cups. The power is controlled and temperature, total pressure, water pressure and water content are continuously being measured.

At termination of the tests, the parcels are extracted by overlapping core-drilling outside the original borehole. The water distribution in the clay is determined and subsequent well-defined chemical, mineralogical analyses and physical testing is performed.

Results

The three remaining test parcels have functioned without any disturbance, and only minor maintenance and improvement work have been made. Water pressure, total pressure, temperature and moisture have been continuously measured and stored every hour, and the data have been checked monthly.

The mineralogical analyses of the A2 parcel by the involved laboratories in Finland, France, Germany, Sweden and Switzerland have been finalised and the comprehensive set of results from all laboratories have been compiled in a technical report which is being reviewed at present. Minor additional laboratory work concerning mineralogy and rheology in the A2 parcel material has continued during 2008. In addition, experimental and modelling of core infiltration experiments is ongoing at the Bern University, Switzerland.

A project meeting was held in Lund in December in order to discuss the results from the A2 parcel analyses in general and mineralogical results in particular. It was decided at the Technical-scientific council meeting in December that the next test parcel retrieval will not be performed before the fall of 2009.

Model development work has been performed, particularly concerning diffusive transport of ions in bentonite. The main results are compiled and published in *Geochimica et Cosmochimica Acta* in the article “Ion equilibrium between montmorillonite interlayer space and an external solution – Consequences for diffusional transport” by Birgersson and Karnland. Complementary small scale laboratory experiments are being performed at Clay Technology. Some of these experiments are presently used as benchmark tests in the Task Force on Engineered Barrier Systems.

4.4 Alternative Buffer Materials

Background and objectives

Bentonite clay has been proposed as buffer material in several concepts for HLW repositories. In the Swedish KBS-3 concept the main demands on the bentonite buffer are to minimise the water flow over the deposition hole, reduce the effects on the canister of a possible rock displacement and prevent sinking of the canister. The MX-80 bentonite from American Colloid Co (Wyoming) has so far been used by SKB as a reference material.

In the Alternative Buffer Materials (ABM) test, eleven different buffer candidate materials with different amount of swelling clay minerals, smectite counter ions and various accessory minerals are tested. The test series is performed in the rock at repository conditions except for the scale and the adverse conditions (the target temperature is set to 130°C). Parallel to the field tests, laboratory analyses of the reference materials are ongoing. The ABM test is a SKB project with several international partners collaborating in the part of laboratory experiments and analyses, see also Chapter 7.

The project is carried out using materials that are possible as future buffer candidate materials. The main objectives are to:

- Compare different buffer materials concerning mineral stability and physical properties, both in laboratory tests of the reference materials but also after exposure in field tests performed at realistic repository conditions.
- Discover possible problems with manufacturing and storage of bentonite blocks.
- Study the interaction between metallic iron and bentonite. This is possible since the central heaters are placed in tubes made of straight carbon steel. The tubes are in direct contact with the buffer.

Experimental concept

The experiment is carried out in similar way and scale as the Lot experiment, see Section 4.3. Three test parcels containing heater, central tube, pre-compacted clay buffer blocks, instruments and parameter controlling equipment have been emplaced in vertical boreholes with a diameter of 300 mm and a depth of 3 m, see Figure 4-11. The slots between buffer blocks and rock are filled with sand which is different compared to the Lot experiment. The sand serves as a filter and will facilitate the saturation of the bentonite blocks. The target temperature in all three parcels is 130°C. Parcel 1 will be retrieved after one to two years operation, parcel 2 after two to four years and parcel 3 after at least five years operation.

Parcel 1 and 2 are artificially wetted whereas parcel 3, which will be in operation for the longest time, only will be wetted if it at some point is found necessary. Parcel 1 and 3 are heated from the very beginning, whereas the heaters in parcel 2 were activated when the buffer was saturated.

In addition, identical plastic covered blocks of the reference materials used in the three test parcels are stored to monitor the effects of storage.

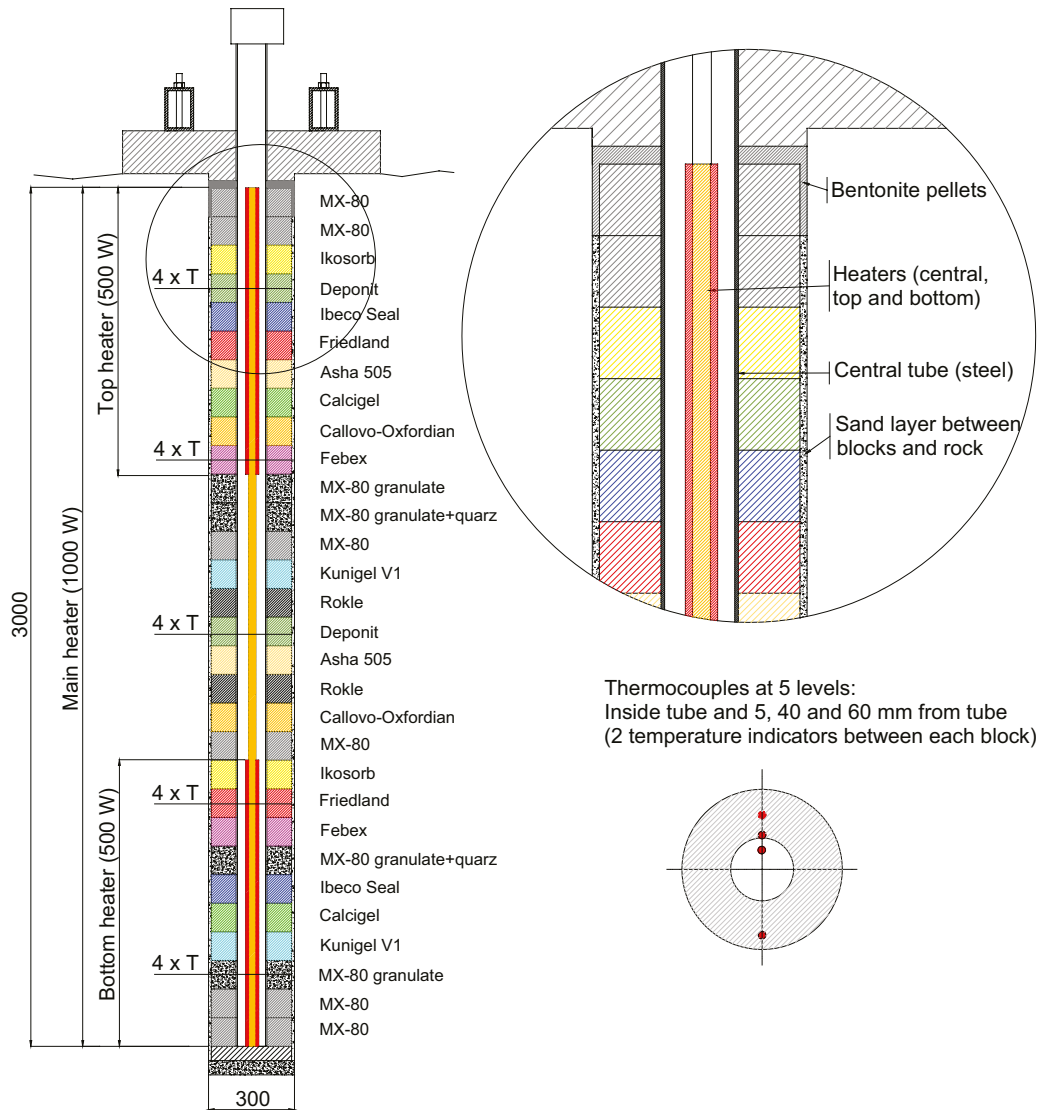

Figure 4-11. Cross section showing the experimental set-up in the Alternative Buffer Materials test. The picture also shows the block configuration in test parcel 1.

Results

Test parcel 1 and 3 have been running at the target temperature i.e. 130°C during 2008 except for a three month period where the temperature in test parcel 1 was decreased below 100°C due to problems with the artificial water saturation system. The water inflow increased and it was decided to decrease the applied water pressure in order to avoid possible erosion of bentonite in the test hole. In order to avoid boiling, depending on the decreased water pressure, it was decided that also the temperature should be decreased. After three months the bentonite had sealed off the leakage ways and the water pressure was increased to its initial level.

The heating of test parcel 2 started in August 2008. The temperature was increased in a first step to about 50°C (the heating of this parcel should start after saturation of the buffer) but since some cracks were formed on the upper concrete plug together with movements it was decided that additional increase of the temperature should be made after the concrete plug has been repaired. The planning of reparation and reinforcement of the concrete plug has started and the work will be performed during February 2009.

A project meeting was held in Lund the 4th of December. At the meeting it was decided to terminate and retrieve test parcel 1 during April 2009.

Analyses of materials

The main part of the planned work with characterisation of the reference materials has been performed and will be reported during 2009. Additional analyses will be performed by B+Tech Oy, Finland, and if possible the results from this work will be included in the report. The planning of the analysis of the material that will be retrieved from parcel 1 is ongoing.

4.5 Backfill and Plug Test

Background and objectives

The Backfill and Plug Test include tests of backfill materials, emplacement methods and a full-scale plug. It is a test of the integrated function of the backfill material and the near-field rock in a deposition tunnel excavated by blasting. It is also a test of the hydraulic and mechanical functions of a plug.

The main objectives of the Backfill and Plug Test are to:

- Develop and test different materials and compaction techniques for backfilling of tunnels excavated by blasting.
- Test the function of the backfill and its interaction with the surrounding rock in full-scale in a tunnel excavated by blasting.
- Develop technique for building tunnel plugs and to test their function.

Experimental concept

The test region for the Backfill and Plug Test is located in the old part of the Zedex tunnel. In Figure 4-12 a 3D visualisation of the experimental set-up is shown. The test region, which is about 30 m long, is divided in three test parts:

- The inner part (six sections).
- The outer part (four sections).
- The concrete plug.

The inner test part is filled with a mixture of bentonite and crushed rock with a bentonite content of 30%. The composition is based on results from laboratory tests and field compaction tests. The outer part is filled with crushed rock with no bentonite additive. Since the crushed rock has no swelling potential, but may instead settle with time, a slot of a few decimetres was left between the backfill and the ceiling. The slot was filled with a row of highly compacted blocks, with 100% bentonite content, in order to ensure a good contact between the backfill and the rock. The remaining irregularities between these blocks and the ceiling were filled with bentonite pellets.

The backfill sections are applied layer wise and compacted with vibrating plates that are developed and built for this purpose. It was concluded from preparatory tests that inclined compaction should be used in the entire cross section from the floor to the ceiling and that the inclination should be about 35 degrees.

Both the inner and outer test parts are divided by drainage layers of permeable mats in order to apply hydraulic gradients between the layers and to study the flow of water in the backfill and near-field rock. The mats are also used for the water saturation of the backfill. The mats were installed in both test parts with the individual distance of 2.2 m. Each mat section was divided in three units in order to be able to separate the flow close to the ceiling from the flow close to the floor and also in order to separate the flow close to the rock surface from the flow in the central part of the backfill.

The outer test part ends with a wall made of prefabricated concrete beams for temporary support of the backfill before casting of the plug. Since in situ compaction of the backfill cannot be made in the upper corner, this triangle was instead filled with blocks of bentonite/sand mixture with 20% bentonite content.

The plug is designed to resist water and swelling pressures that can be developed. It is equipped with a filter on the inside and a 1.5 m deep triangular slot with an "O-ring" of highly compacted bentonite blocks at the inner rock contact.

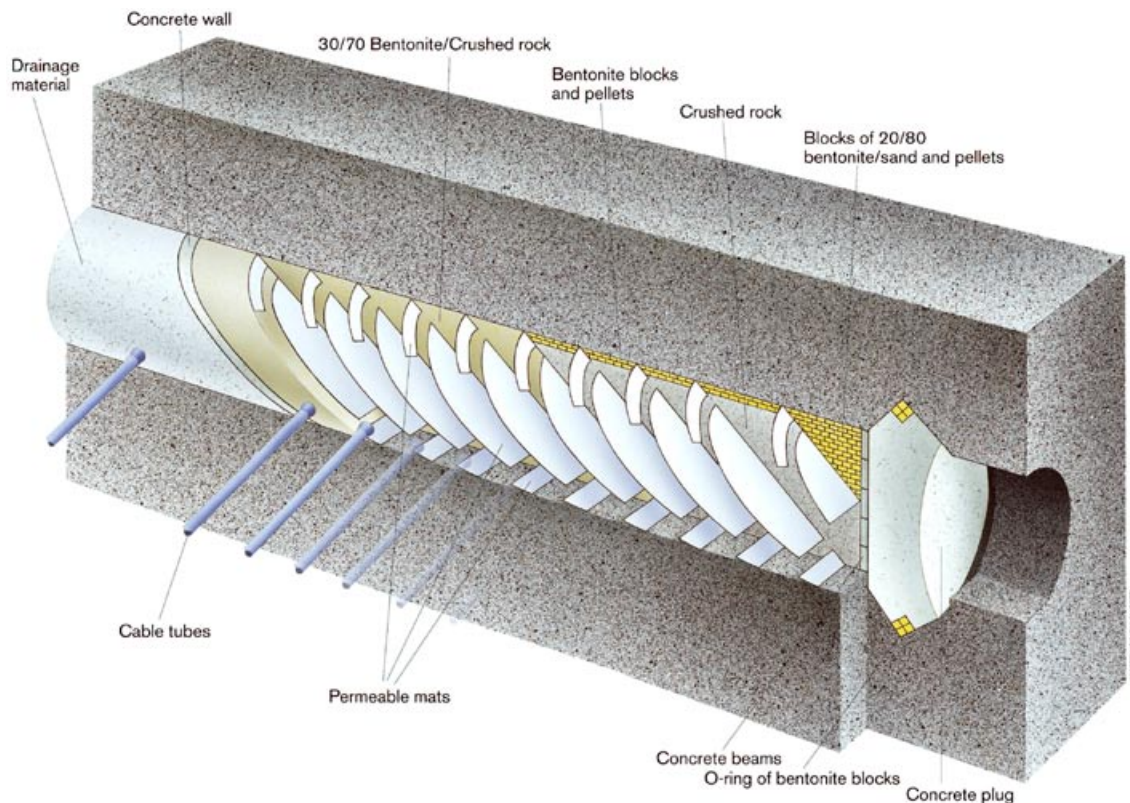

Figure 4-12. Illustration of the experimental set-up of the Backfill and Plug Test.

The backfill and rock are instrumented with piezometers, total pressure cells, thermocouples, moisture gauges, and gauges for measuring the local hydraulic conductivity. The axial conductivities of the backfill and the near-field rock were after water saturation tested by applying a water pressure gradient along the tunnel between the mats and measuring the water flow. All cables from the instruments are enclosed in Tecalan tubes to prevent leakage through the cables. The cables are led through the rock in boreholes drilled between the test tunnel and the neighbouring demonstration tunnel hosting the data acquisition room.

Results

The installation was completed and the wetting of the backfill from the permeable mats started at the end of 1999. The water pressure in the mats was increased to 500 kPa in steps of 100 kPa between October 2001 and January 2002 and kept at 500 kPa until the backfill was judged to be water saturated in the beginning of 2003. During 2003 the equipment was rebuilt for flow testing and the flow testing started at the end of that year. The year 2004 and most of 2005 were used for flow testing of the six test sections of the 30/70 bentonite/crushed rock mixture in the inner part of the tunnel.

In 2006 measurements of (a) hydraulic conductivity in single points by pressurising filter equipped tubes and (b) the water flow into the backfill were performed in the inner part. These tests largely confirmed the previous results although a somewhat lower hydraulic conductivity was measured. During 2007 the compressibility of the backfill was measured by a stepwise pressurisation of the four pressure cylinders (diameter 0.5 m).

During 2008 it was planned to do hydraulic testing of the local hydraulic conductivity of the crushed rock with the so called “CT-tubes” but due to priority changes these measurements have been postponed.

The test has been monitored and measured results from all sensors except for the relative humidity sensors have been logged. A data report covering the period 1st June 1999 up to 1st January 2007 is available /Goudarzi et al. 2008a/.

In addition to the field testing, laboratory experiment and modelling with the aim to evaluate the hydraulic conductivity of the backfill materials are in progress but are delayed.

4.6 Canister Retrieval Test

Background and objectives

The stepwise approach to safe disposal of spent nuclear fuel implies that if the evaluation of the deposition after the initial stage is not judged to give a satisfactory result the canisters may need to be retrieved and handled in another way. The evaluation can very well take place so long after deposition that the bentonite has swollen and applies a firm grip around the canister. The canister, however, is not designed with a mechanical strength that allows it to be just pulled out of the deposition hole. The canister has to be made free from the grip of the bentonite before it can be taken up.

The Canister Retrieval Test (CRT) is aiming at demonstrating the readiness for recovering of emplaced canisters also after the time when the bentonite is fully saturated and has its maximum swelling pressure. The overall aim is to demonstrate to specialists and to the public that retrieval of canisters is technically feasible during any phase of operation. The following was defined to fulfil the aim of the CRT:

- Two vertically bored test holes in full repository scale, which fulfil the quality requirements deemed necessary for the real repository.
- Careful and documented characterisation of the properties of these holes including the boring disturbed zone.
- Emplacement of bentonite blocks, bentonite pellets and canisters with heaters, and artificial addition of water. However, only one of these deposition holes has been used for implementation of the Canister Retrieval Test.
- Saturation and swelling of the buffer are monitored under controlled conditions.
- Preparations for and demonstration of canister retrieval.

Boring of full-scale deposition holes, geometrical and geotechnical characterisation of holes as well as emplacement of bentonite and canister with heaters were made within sub-projects that concern also other tests in the Äspö HRL. In addition to the retrieval test, the results from monitoring of the buffer and the laboratory testing of excavated parts of the buffer will be used to increase the understanding of the THM processes in a deposition hole.

Experimental concept

The Canister Retrieval Test is located in the main test area at the –420 m level. The tunnel is excavated by conventional drill and blast techniques and is 6 m wide and 6 m high. The test period is separated into three phases:

- Installation Phase – Boring of deposition holes and installation of instrumented bentonite blocks and canister with heaters in one hole. This hole is covered in the top with a lid of concrete and steel.
- Saturation Phase – Saturation of the bentonite and evolution of the thermal regime with measurement of thermal, hydraulic and mechanical processes.
- Retrieval Phase – Test of freeing the canister from the bentonite, docking the gripping device to the canister lid and lifting of the canister up to the tunnel floor and into the radiation shield on the deposition machine (reversed deposition sequence).

The buffer was installed in the form of blocks of highly compacted Na-bentonite, with a full diameter of 1.65 m and a nominal height of 0.5 m. Instruments for measuring temperature, relative humidity, total pressure and pore pressure were installed in the bentonite in many of the blocks. When the stack of blocks was 6 m high the canister equipped with electrical heaters was lowered down in the centre. Cables to heaters, thermocouples in the rock and strain gauges in the rock were connected, and additional blocks were emplaced until the hole was filled up to 1 m from the tunnel floor. On top, the hole was sealed with a plug made of concrete and a steel plate as cover. The plug was secured against heave caused by the swelling clay with 9 cables anchored to the rock. The tunnel was left open for access and inspections of the plug support. The experimental set-up is shown in Figure 4-13.

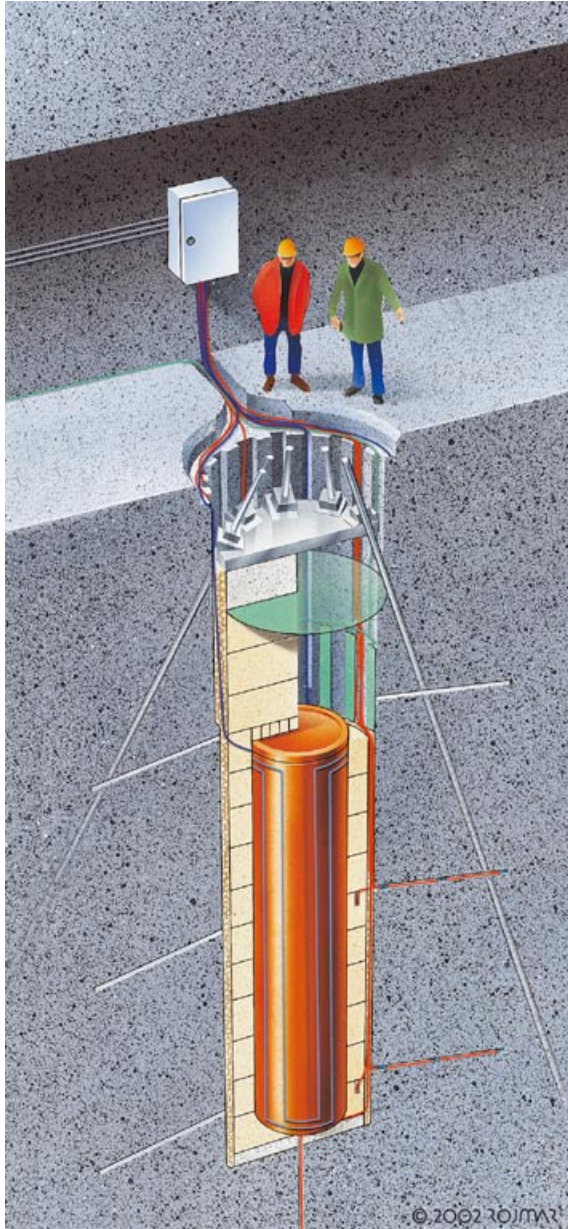

Figure 4-13. *Illustration of the experimental set-up of the Canister Retrieval Test.*

Artificial addition of water was provided evenly around the bentonite blocks by means of permeable mats attached to the rock wall. The design of the mats was done so that they are not disturbing the future test of retrieval.

The predicted saturation time for the test was 2–3 years in the 350 mm thick buffer along the canister and 5–10 years in the buffer below and above the canister. The instrumentation in the buffer was similar to the instrumentation in the Prototype Repository and yield comparable information during the saturation phase.

Results

Canister and bentonite blocks were emplaced in 2000 and the hole was sealed with a plug, heater turned on and artificial water supply to saturate the buffer started. In January 2006 the retrieval phase was initiated and the canister was successfully retrieved in May 2006. The saturation phase had, at that time, been running for more than five years with continuous measurements of the wetting process, temperature, stresses and strains.

Besides verifying the retrieval technique, the Canister Retrieval Test also provides possibilities to study the characteristics of the buffer at a fully water saturated state. When excavating the experiment, the upper half of the buffer was therefore sampled and analyses of these samples have been performed during the past year. The recorded sensor data during the experiment and the analyses after the excavation also provide possibilities to test how well numerical models capture the processes in the buffer during saturation. The data may also be used for calibrating numerical models.

Buffer analyses

The analyses concern: chemistry/mineralogy, swelling pressure/hydraulic conductivity and investigations of the mechanical characteristics. Some of the findings from the analyses are given below. The results should, however, be considered as preliminary since they have not been published yet.

- No significant differences have been found in chemistry/mineralogy in buffer samples close to and above the canister. The lubricant used when manufacturing the bentonite blocks complicated the analyses somewhat.
- The buffer samples show insignificant differences in hydraulic conductivity as well as swelling pressure when compared with reference material. This can be seen in Figure 4-14 and Figure 4-15 where hydraulic conductivity and swelling pressure are given as a function of dry density for ring 4 and ring 7.
- The buffer samples close to the canister have been found to have more brittle mechanical characteristics as compared to samples further away from the canister.
- Additional analyses have been planned. Concerning the chemical/mineralogical analyses, an investigation of the penetration of the lubricant will be performed. To obtain higher statistical significance when studying the mechanical characteristics of the material close to the canister, another 10 samples are to be tested.

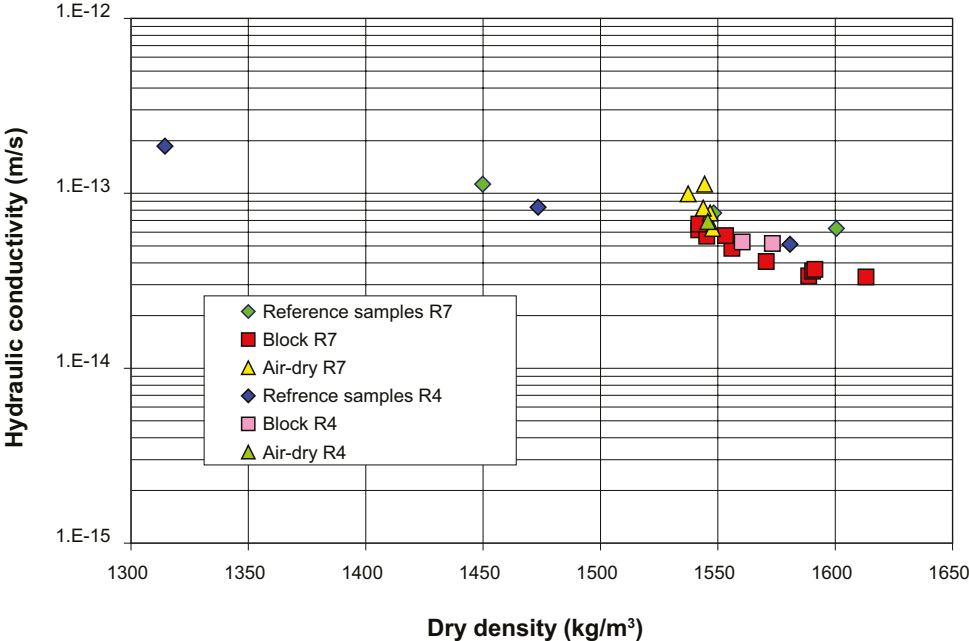

Figure 4-14. Hydraulic conductivity given as a function of dry density for CRT samples and reference material for ring 4 and ring 7.

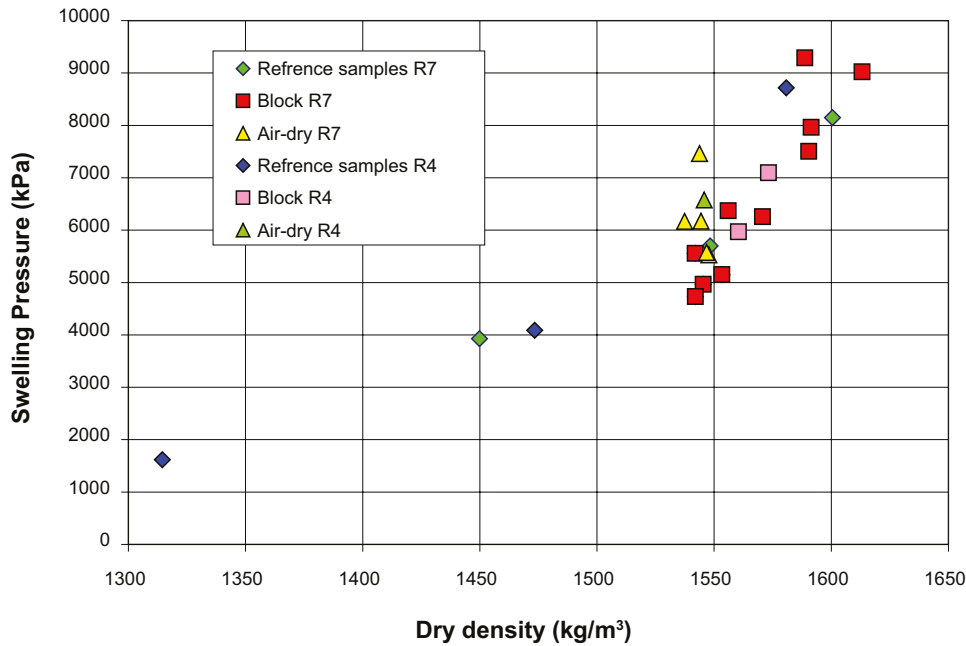

Figure 4-15. Swelling pressure given as a function of dry density for CRT samples and reference material for ring 4 and ring 7.

Numerical modelling

In the Task-Force on Engineered Barrier Systems (EBS Task-Force) the Canister Retrieval Test was selected to be one of the large scale field tests. The first results from the modelling were presented at a meeting in May. The modelling by the EBS Task-Force teams has progressed during 2008 and more results were presented at the meeting held at 12–13 November 2008. One of the results to be presented in the assignment is the dry density profile after homogenisation. In Figure 4-16 the dry density profiles at the initial conditions and at the excavated state obtained by analysing the samples and results obtained from using the model developed by SKB Team 1 are shown.

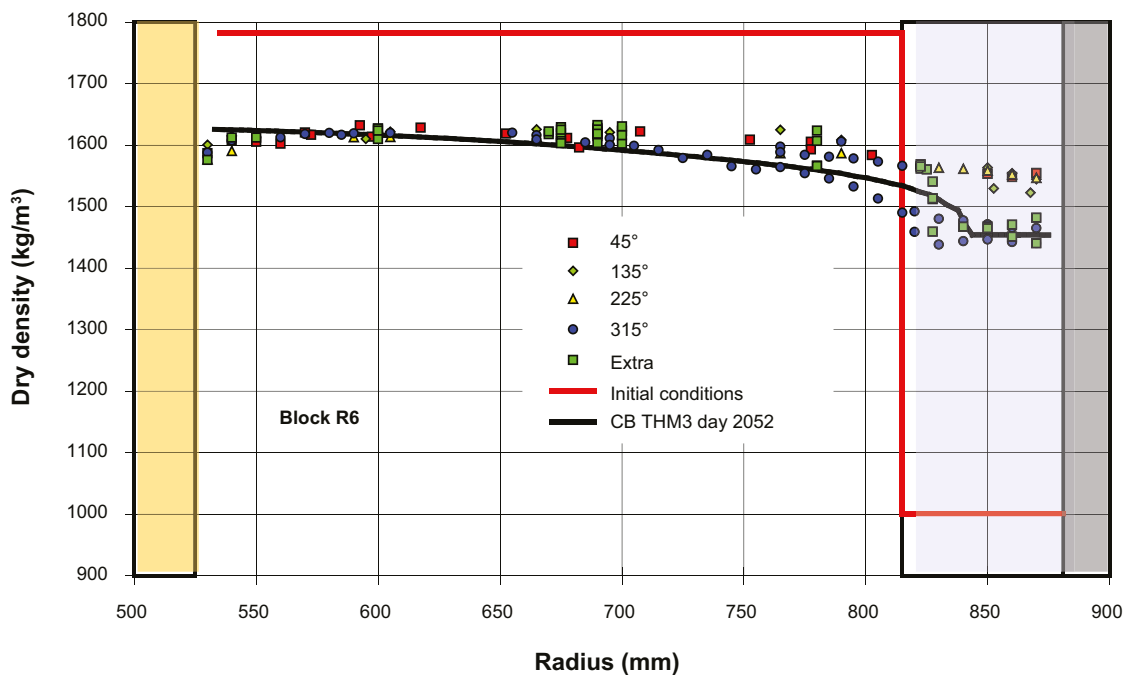

Figure 4-16. Dry density profiles; initial conditions (red solid), analysed excavated samples (markers) and results from modelling the end of the test at day 2052 (black solid) using the SKB Team 1 model.

4.7 Temperature Buffer Test

Background and objectives

The Temperature Buffer Test (TBT) is carried out by Andra at Äspö HRL in co-operation with SKB. TBT aims at verifying and possibly improving current THM models of buffer materials at high temperatures, well over 100°C. Moreover, the experimental setup has been characterised by stationary, well defined, boundary conditions. This implies that the experimental activities at the test site up till 2006 have been run mostly at a routine basis, while the focus has been on different modelling tasks and general successive evaluation of obtained results.

The Temperature Buffer Test aims at improving the current understanding of the thermo-hydro-mechanical behaviour of clay buffers at temperatures around and above 100°C during the water saturation transient, in order to be able to model this behaviour.

Experimental concept

TBT is located in the same test area as the Canister Retrieval Test (CRT) at the -420 m level. Two identical heaters, each 3 m long and 0.6 m in diameter, are stacked in a vertical 1.8 m diameter deposition hole. The principle design of the test and the experimental set-up are shown in Figure 4-17. Two buffer arrangements are being investigated:

- One heater is surrounded by bentonite in the usual way, allowing the temperature of the bentonite to exceed 100°C locally.
- The other heater has a ring of sand between the heater and the bentonite, as thermal protection for the bentonite, the temperature of which is kept below 100°C.

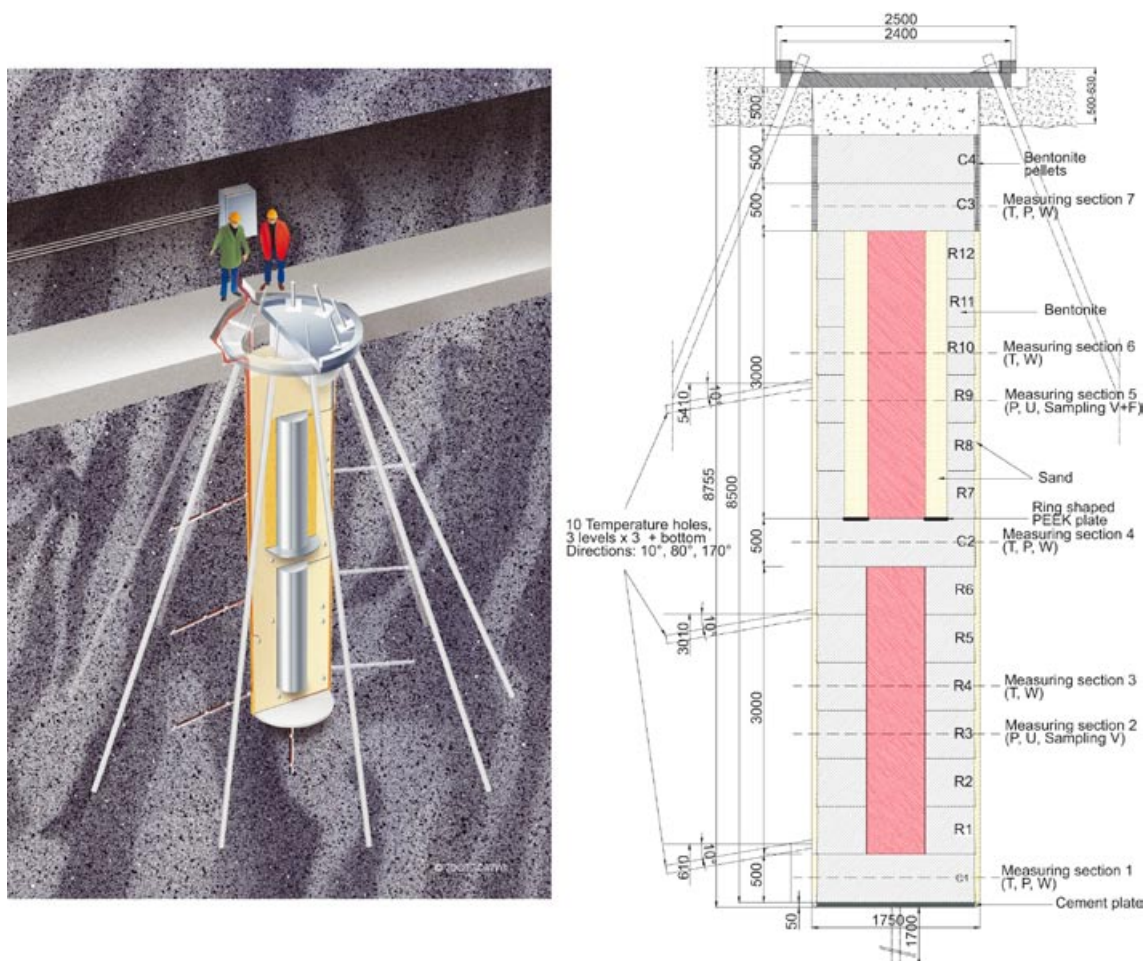

Figure 4-17. Principle design and experimental set-up of the Temperature Buffer Test.

The principle of the TBT test is to observe, understand and model the behaviour of the deposition hole components, starting from an initial unsaturated state under thermal transient and ending with a final saturated state with a stable heat gradient.

Heat transfer comes into play from the start of the test, possibly redistributing water being present in the buffers, with partial desaturation of very hot zones ($>100^{\circ}\text{C}$). Inflow of water then causes saturation and consequent swelling of the bentonite.

The effects of a bentonite desaturation/resaturation cycle on the confinement properties are not well known. An open question which TBT is designed to answer is whether the mechanical effects of desaturation (cracking of the material) are reversible.

The similar geometries of CRT and TBT, the similar artificial water saturation systems, and the use of MX-80 bentonite buffer will facilitate interpretation of data and comparisons of results.

Results

The Temperature and Buffer Test has been in operation since 2003. The evaluation of THM processes has been made through analysis of sensors data (for the latest report, see /Goudarzi et al. 2008b/), through numerical modelling /Hökmark et al. 2007, Åkesson 2006a, Ledesma and Jacinto 2007/ and through evaluation and numerical modelling of parallel lab-scale mock-up tests /Åkesson 2006b, Åkesson 2008, Ledesma et al. 2006/. The final evaluation of the field test will be made when data from the future dismantling and sampling will be available.

A number of experimental activities have been planned for the period 2007–2009. Three steps have been identified for the activity planning of the upper package: (1) evaluation of the THM processes (2) a gas injection test and (3) a retrieval test. The gas test will however not be carried out since it has been shown that the buffer around the sand shield is not tight.

For the lower package the evaluation of the THMC processes, with operation at high temperatures, is the main point of interest. In order to promote mineralogical alteration processes in the lower package, the thermal output from the heaters was changed during the last two months of 2007. The power from the lower heater was increased from 1,600 to 2,000 W, while the output from the upper heater was decreased from 1,600 W to 1,000 W. The temperature distribution at the end of 2008 is shown in Figure 4-18. At this time the temperature on the mid-section of the lower heater was 155°C . The corresponding value for the upper heater was 86°C . All operational capacitive relative humidity sensors now indicate saturated vapour while there is no longer any signals from the psychrometers.

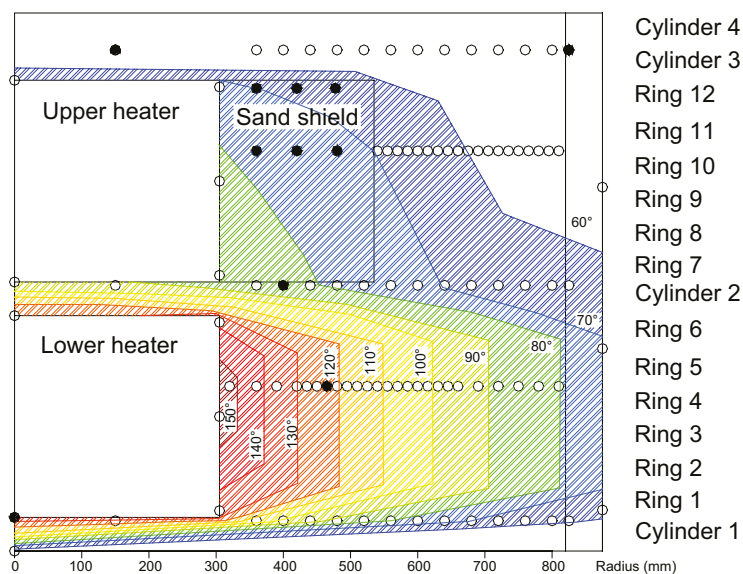

Figure 4-18. Temperature distribution at January 1st 2009. Rings indicate sensor positions. Filled rings indicate sensors out of order.

A plan with a cost estimate for the remaining project period was elaborated in April 2008. A dismantling planning meeting was held in Lund in December 2008. The current plan is to perform a retrieval test of the upper heater, and to dismantle and sample the test during the period from November 2009 to February 2010. The planning of this operation will continue during 2009.

Sand shield hydration

The hydration activity, with continuous pressurisation, was launched in September 2007 with the aim to saturate the sand shield around the upper heater with water, see Figure 4-19. The injection points in the shield (or their surroundings) exhibited a high flow resistance which limited the rate of hydration, and therefore was high injection pressures (20 – 40 bar) applied. The flow resistance decreased however with time and at the end of December 2007 it was possible to inject approximately 10 litres per day.

The shield pressure (as recorded by the pore pressure sensor in the shield) increased in the second half of January 2008 and peaked around February 10th. At the same time a significant leakage was observed from two of the slots at the lid, and the pressurisation of the shield as well as the filter was therefore reduced. The total amount of water injected during the first hydration attempt and the continuous pressurisation was approximately 540 litres, which can be compared with the estimated available pore volume of 580 litres.

A preliminary hydraulic test was performed between March 17th and April 1st. This confirmed that the buffer around the sand shield was not tight. The leakage could possibly occur through the array of external thermo-couples or through the slots cut out for the heater cables. The planned gas injection tests will therefore not be carried out.

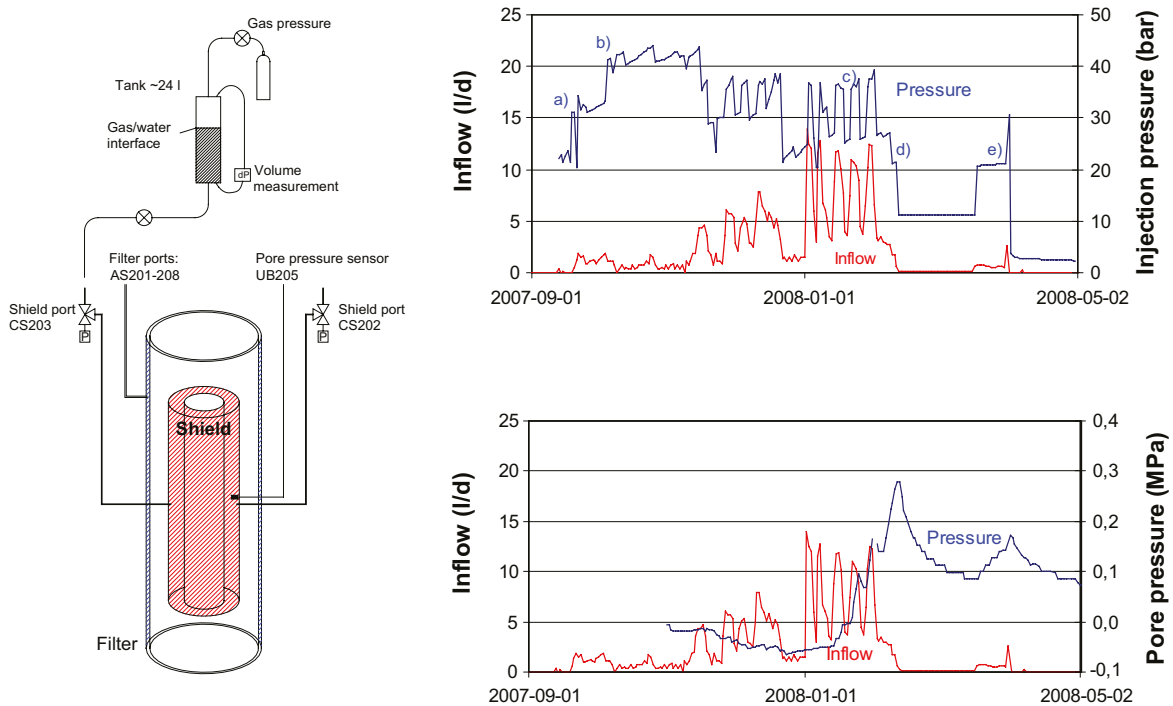

Figure 4-19. Ports and instrumentation for shield hydration (left). Pressure and inflow during the continuous pressurisation (right). Upper graphs shows the injection pressure and lower graph shows the registered pore pressure: (a) significant inflow when injection pressure was increased from 20 to 30 bar, (b) injection pressure increased from 30 to 40 bar, (c) leakage was detected in the middle of January, (d) pressurisation was reduced to 10 bar with the peaking of pore pressure and (e) preliminary hydraulic test.

Pressure evolution in lower package

The pressures, as recorded by the two innermost pressure sensors in Ring 3 around the lower heater, decreased significantly during August and September 2008. The total pressure (PB204) decreased from approximately 7 to 4 MPa (see Figure 4-20), while the pore pressure (UB201) decreased from approximately 1 to 0.3 bar. The continued evolution of these pressures may reveal if this is a temporary trend or a real change, possibly associated with the high temperatures presently prevailing around the lower heater. This pressure decrease had not recovered at the end of 2008. Apart from these trends, the total pressures and the cable forces appear to have stabilised in general, see Figure 4-21.

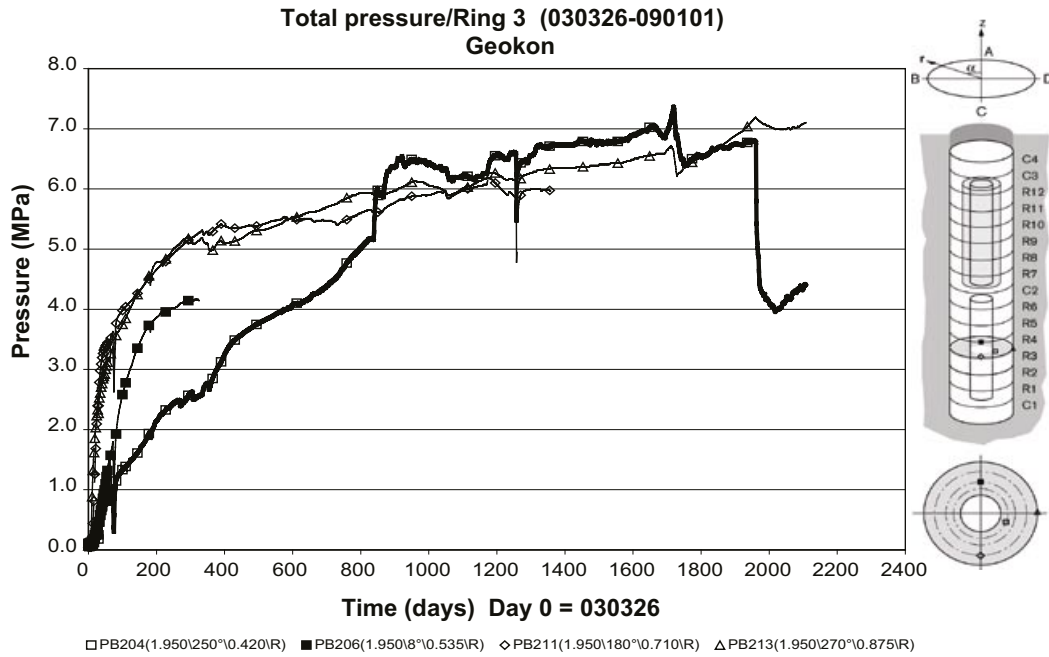

Figure 4-20. Radial total pressure in Ring 3.

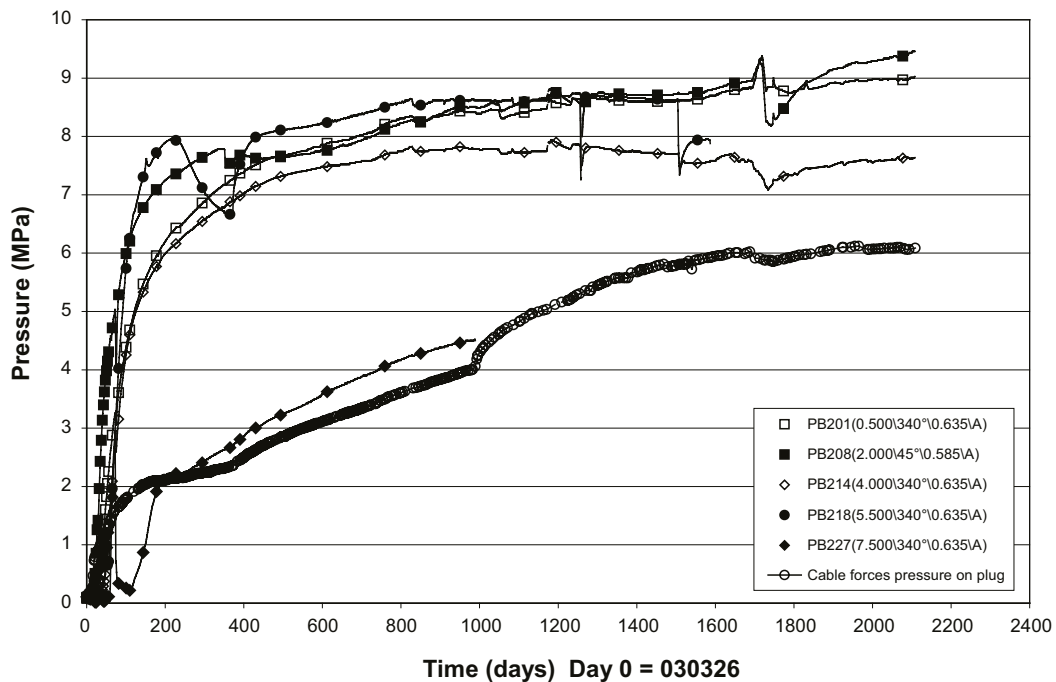

Figure 4-21. Axial pressure measured in different sections. Cable forces are shown as pressures, assuming an even distribution over the rock hole area (2.40 m²).

4.8 KBS-3 Method with Horizontal Emplacement

Background

The KBS-3 method, which is based on the multi-barrier principle, has been accepted by the Swedish authorities and the government as a basis for planning the final disposal of spent nuclear fuel. The possibility to modify the reference design and make a serial deposition of canisters in long horizontal drifts (KBS-3H), see Figure 4-22, instead of vertical emplacement of single canisters in separate deposition hole (KBS-3V) which is SKB's reference design, has been considered since early nineties. The deposition process for KBS-3H requires the assembly of each copper canister and its buffer material in a prefabricated, so-called Supercontainer.

Most of the positive effects of horizontal emplacement compared with vertical emplacement are related to the smaller volume of excavated rock. Examples of positive effects are:

- Less environmental impact during construction.
- Reduced disturbance on the rock mass during construction and operation.
- Reduced cost for construction and backfilling of the repository compared to KBS-3V. However, great efforts are required developing the KBS-3H design.

At the end of 2001 SKB published a RD&D programme for the KBS-3 method with horizontal emplacement. The RD&D programme /SKB 2001/ which is divided into four stages: Feasibility study, Basic design, Demonstration of the concept at Äspö HRL and Evaluation is carried through by SKB in co-operation with Posiva.

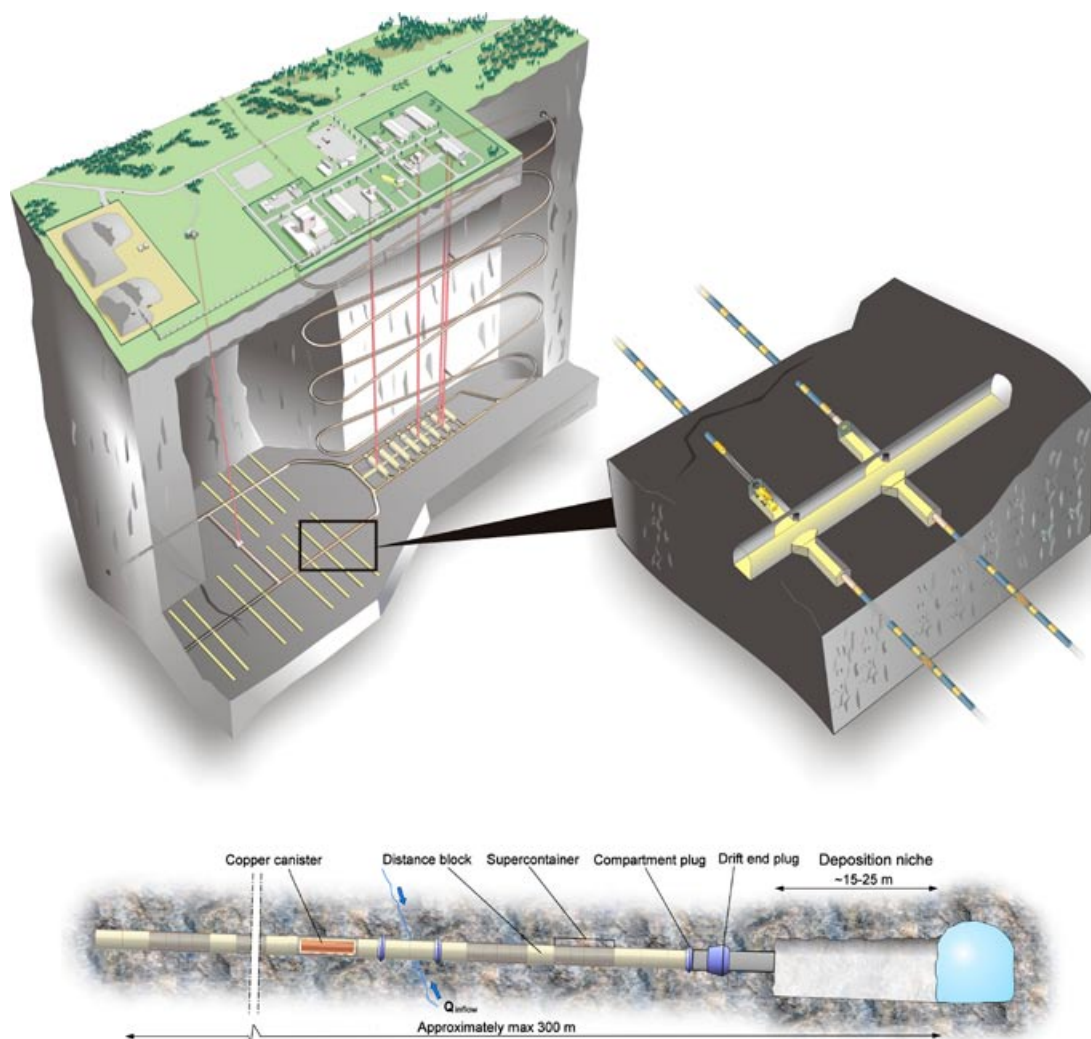

Figure 4-22. Schematic illustrations of KBS-3 with horizontal emplacement.

Feasibility study and basic design, 2001–2003

The work on evaluating the feasibility of the method during 2001–2003 showed that KBS-3H is a promising alternative to KBS-3V, and therefore SKB and Posiva jointly decided to develop and demonstrate technology and to further investigate safety, environment and cost issues. A new feature of the KBS-3H design was the use of a Supercontainer, i.e. that the canister and buffer, surrounded by a shell would be deposited as a package in the horizontal deposition drift.

Demonstration, 2004–2007

The key issues that were highlighted for further study in the 2004–2007 phase of the programme were long-term safety, the overall KBS-3H design and specific buffer issues, the excavation of the deposition drift, assemblage and emplacement of the Supercontainer as well as retrievability, cost and environmental impacts.

The KBS-3H project made substantial achievements during 2004–2007: Two full-scale horizontal drifts were bored at Äspö HRL for the demonstration of the deposition of a mock-up Supercontainer and several other full-scale tests. The prototype equipment for the deposition was manufactured and tested in Äspö in realistic environment. The trial deposition of the 46 tonnes mock-up container was successful. Alternative designs for the KBS-3H have been prepared, as well as, an adaptation of an exploratory layout of a KBS-3H repository at the Olkiluoto site. Buffer tests were carried out at different scales. A safety assessment for a deep repository at Olkiluoto site based on KBS-3H was developed and the conclusion is that the KBS-3H design alternative offers potential for the full demonstration of safety for a repository at Olkiluoto site and for the demonstration that it fulfils the same long-term safety requirements as KBS-3V.

Some major uncertainties were detected during the project of which several are common with KBS-3V. For example the behaviour of the buffer during the operational period and subsequent period of buffer saturation, where the risk for piping and erosion of bentonite may occur even for very low amount of water inflows (the present estimated limit is 0.1 L/min). KBS-3H specific issues were identified based on the safety assessment. Many of these are related to the impact of the steel shell in the Supercontainer and other steel structural materials present in the drift.

Evaluation

The work from the project phase during 2004–2007 is compiled in three main reports:

- Horizontal deposition of canisters for spent nuclear fuel – Summary of the KBS-3H project 2004–2007 /SKB 2008d/.
- KBS-3H Design Description 2007 /Autio et al. 2008/.
- Safety assessment for a KBS-3H spent nuclear fuel repository at Olkiluoto – Summary report /Smith et al. 2008/.

Objectives

The results of the technical investigations, practical trials and assessments of the long-term safety and the benefits of the alternative show that there is justification for continuing with a fourth stage of the research programme – Complementary studies. Therefore SKB and Posiva jointly decide to continue the RD&D programme for KBS-3H for the period 2008 to August 2010. The main goal of this project phase is to develop the KBS-3H method to such a state that the decision on full-scale testing and demonstration can be made. This requires additional evidence on:

- The behaviour of the buffer and other components (container and plugs) after emplacement.
- The long-term performance of the buffer including interaction with other materials.
- Construction, manufacturing and installation of the system.

The project is divided in four sub-projects: (a) Drift design, (b) Safety case, (c) Production and operation and (d) Demonstration and planning of full-scale test.

Demonstration site

The need to demonstrate the KBS-3H design was foreseen in the KBS-3H feasibility study. Investigations into a suitable location and preparation of a demonstration site at Äspö HRL were decided upon. The demonstration site is located at the –220 m level in a niche with the dimensions 15 by 25 meters. The niche is designed to accommodate the vehicles, machinery and auxiliary equipment used for drilling the holes. Two horizontal holes with a diameter of 1.85 m have been excavated, one hole is 15 m long and the other is 95 m. The short hole is used for construction and testing of e.g. a low-pH shotcrete plug and other for design of drift components. The long hole is primarily used for demonstration of the deposition equipment and also for some full-scale tests.

Results

Below is the main work and results performed at the Äspö HRL during 2008 presented. Other work in the current project phase are not presented in this report.

MegaPacker tests

During 2008 the testing of the MegaPacker was finalised. In total 5 water bearing fracture zones have been characterised and grouted using the MegaPacker and SilicaSol at the –220 m level at Äspö HRL. The results from the different grouting rounds are very good. The measured groundwater inflow and pressure in the tunnel after different grouting rounds are given in Table 4-2. As seen the groundwater requirements on the MegaPacker in this test campaign have been fully achieved. The equipment is shown in Figure 4-23.

Table 4-2. An overall presentation of measured inflow and groundwater pressures in the tunnel after different grouting rounds.

		Position 1	Position 2	Position 3	Position 4	Position 5
November 2006*	Water inflow (ml/min)	2,960	90	870	2,240	280
	Groundwater pressure (bar)					
November 2007	Water inflow (ml/min)	2,400	25	490	1,470	148
	Groundwater pressure (bar)	> 1.4	>1.45	8.3	7.9	3.6
March 2008 Before grouting of position 2, 4 and 5	Water inflow (ml/min)	–	–	–	–	190
	Groundwater pressure (bar)	–	–	–	–	7.0
March 2008 After grouting of position 5	Water inflow (ml/min)	–	–	–	1,760	–
	Groundwater pressure (bar)	–	–	–	10.7	–
March 2008 After grouting of position 4 and 5	Water inflow (ml/min)	–	145	–	–	–
	Groundwater pressure (bar)	–	11.0	–	–	–
March 2008 After grouting of all positions	Water inflow (ml/min)	4	7	15	3	25
	Groundwater pressure (bar)	–	–	–	–	–

* = No information about the type of measurement method being used has been received from Sicada.



Figure 4-23. The MegaPacker used for grouting.

Pipe removal tests

Water and air evacuation pipes in the DAWE design variant have to be removed after use. Tests were carried out during 2008 to verify the ability to do so. Three tests were conducted in small scale in the Bentonite Laboratory at Äspö. A three meter long steel tube was filled with buffer, one steel pipe and water was inserted into the tube. The buffer expanded and pressed the pipe to the side of the tube – simulating the buffer pressing the pipe to the rock wall. The required force to pull the pipe loose was measured and analysed. Test results indicate that a higher force than estimated is needed to remove the pipes. The test concludes that the pipes must be removed quickly after use, e.g. within the first days after use.

Compartment plug test

The installation of the first compartment plug was initiated during 2008. Two rock notches were excavated by sawing. The sawing method showed to work fine and only minor adjustments in the method and equipment were made between the two excavations. In December the first pieces of the compartment plug, the fastening ring, were installed in the rock notch. The installation will be completed in the beginning of 2009. The test phase of the compartment plug will be completed in autumn 2009.

Test of the KBS-3H deposition equipment

Tests with the KBS-3H deposition equipment continued during 2008. The additional tests with the deposition machine were after several months of delay finally finalised during December. The results looks promising but necessary improvements have to be considered to make the equipment more robust. Compilation of test data and reporting will be carried out during 2009.

4.9 Large Scale Gas Injection Test

Background

The multiple barrier concept is the cornerstone of all proposed schemes for the underground disposal of radioactive wastes. Based on the principle that uncertainties in performance can be minimised by conservatism in design, the concept invokes a series of barriers, both engineered and natural, between the waste and the surface environment. Each successive barrier represents an additional impediment to the movement of radionuclides. In the KBS-3 concept, the bentonite buffer serves as a diffusion barrier between the canister and the groundwater in the rock. An important performance requirement of the buffer material is that it should not cause any harm to the other barrier components. Gas build-up from, for example, corrosion of the iron insert, could potentially affect the buffer performance in three ways:

- Permanent pathways in the buffer could form at gas breakthrough. This could potentially lead to a loss of the diffusion barrier.
- If gas can not escape through the buffer, the increase in pressure could lead to mechanical damage of other barrier components.
- The gas could de-hydrate the buffer.

Current knowledge pertaining to the movement of gas in initially water saturated buffer bentonite is based on small-scale laboratory studies. While significant improvements in our understanding of the gas-buffer system have taken place, recent laboratory work has highlighted a number of uncertainties, notably the sensitivity of the gas migration process to experimental boundary conditions and possible scale-dependency of the measured responses. These issues are best addressed by undertaking large scale gas injection tests.

Objectives

The aim of the Large Scale Gas Injection Test (Lasgit) is to perform a gas injection test in a full-scale KBS-3 deposition hole. The objective of this experimental programme is to provide data to improve process understanding and test/validate modelling approaches which might be used in performance assessment. Specific objectives are:

- Perform and interpret a large scale gas injection test based on the KBS-3 repository design concept.
- Examine issues relating to up-scaling and its effect on gas movement and buffer performance.
- Provide additional information on the processes governing gas migration.
- Provide high-quality test data to test/validate modelling approaches.

Experimental concept

Lasgit is a full-scale demonstration project conducted in the assembly hall area in Äspö HRL at a depth of -420 m, see Figure 4-24. A deposition hole, 8.5 m deep and 1.8 m in diameter, was drilled into the gallery floor. A full-scale KBS-3 canister (without heater) was placed in the deposition hole. Thirteen circular filters of varying dimensions have been positioned on the surface of the canister to provide point sources for the injection of gas, in affect mimicing canister defects. Pre-compacted bentonite blocks (with a high initial water saturation) were installed in the deposition hole around the modified canister. The hole has been capped by a conical concrete plug retained on position by a reinforced steel lid capable of withstanding over 5,000 tonnes of force.

In the field laboratory instruments continually monitor variations in the relative humidity of the clay, the total stress and porewater pressure, the temperature, displacement of the lid and the restraining forces on the rock anchors. The experiment can be considered as a “mock-up test” which does not use any radioactive materials.

In essence the Lasgit experiment consists of three operational phases; the installation phase, the hydration phase and the gas injection phase. The installation phase was undertaken from 2003 to early 2005 and consisted of the design, construction and emplacement of the infrastructure necessary to perform the Lasgit experiment.



Figure 4-24. Panorama of the Large Scale Gas Injection Test at the –420 m level in Äspö HRL.

The first hydration phase began on the 1st February 2005 with the closure of the deposition hole. The aim of this phase of the experiment is to fully saturate and equilibrate the buffer with natural groundwater and injected water. The saturation is monitored by measuring pore pressure, total pressure and suction at both the buffer/rock interface and key locations within individual clay blocks. The hydration phase provides an additional set of data for (T)HM modelling of water uptake in a bentonite buffer.

When the buffer is considered to be fully saturated, the main gas injection phase will start. A series of detailed gas injection tests will be performed and the processes and mechanisms governing gas flow in the bentonite will be examined.

During the hydration phase, a number of preliminary gas injection tests will be performed. The first of these was undertaken during 2007 with a view to verifying the operation and data reduction methodologies outlined in the original concept report and to provide qualitative data on hydraulic and gas transport parameters for a bentonite buffer during the hydration process. This phase of testing was completed in February 2008, at which time artificial hydration of the clay recommenced through all available filters.

Results

Preliminary gas and hydraulic tests were completed in the first quarter of 2008. These were followed by a second stage of hydration, focussing on the continued resaturation of the clay. Flux into the deposition hole, total stress and porewater pressure were all monitored with time in order to track the evolution of the system. In August 2008 Lasgit underwent routine recalibration. Shortly after this time, failure of the air compressor led to the closure of all servo-assisted valve work, in affect, isolating the canister filters from the hydration system. However, this unplanned event provided an unexpected opportunity to simultaneously retest the hydraulic properties of the clay around all 12 canister filters as water pressures in the system decayed.

Throughout the second phase of hydration a number of small discrete movements of the large steel retaining lid covering the Lasgit deposition hole have been noted. These are in addition to the normal background displacements caused by straining of the lid as the clay hydrates. As expected, data indicated that deformation of the lid is greatest at its centre resulting in convexing of the lid in the area surrounding the Monel pipe. During the early part of 2008 a significant number of blasting events took place at the Äspö HRL as new tunnels were excavated for ongoing research projects. While a number of minor events in the data were noted, few if any can be directly attributed to blasting.

Following re-calibration of the test system in August 2008, two lateral displacement sensors were added to the canister to provide additional data on the movement of the lid. Since restarting hydration (following the commissioning of the replacement compressor in October 2008), these lateral sensors have provided valuable data to help decipher subsequent lid movements which can now be correlated to downhole changes in load as the system continues to evolve.

During 2008 a concerted effort was placed on the quality assurance of the Lasgit data and the preparation of a detailed summary report. The latter document, which will be complete in 2009, contains an overview of all salient work performed in and around the Lasgit deposition hole and an extensive re-examination of the test data to date. Particular emphasis has been placed on the interpretation of short- and long-term variations in parameters caused as a direct consequence of both buffer hydration (including hydraulic and gas testing) and external events such as blasting or seasonal change. In the latter case, these underlying relationships help to define the nature of the boundary conditions to the Lasgit test and provide important process understanding necessary for the full interpretation of data.

Recent analysis of data derived from the Lasgit experiment has also highlighted a long-term declining porewater pressure trend observed in the host rock surrounding the deposition hole. Further investigation using data from neighbouring boreholes indicates a declining trend within the HRL around the 420–450 m zone. At present the cause for this temporal behaviour, which appears to predate Lasgit, is unclear, but it provides an example of the quality of the data (and its wider impact) obtained from the Lasgit study.

In 2009 a second series of gas injection tests will be performed as part of the ongoing hydration phase. These tests will provide quantitative data on the hydraulic and gas transport parameters of the bentonite as the buffer continues to hydrate. In anticipation of these tests it was decided to monitor the neighbouring pressure relief holes for future signs of gas discharge in order to provide additional information to help improve process understanding of the local fracture system and the movement of gas in the host rock surrounding the deposition hole. During this reporting period the design and specification of a sampling protocol has been agreed and neon selected as the gas to be used in the next stage of gas testing.

The test has now been in successful operation for in excess of 1,400 days. The first phase of the project comprised of the initial hydration, hydraulic and gas test stages has now been successfully completed with data distributed to the international project partners. The Lasgit experiment continues to yield high quality data amenable to the development and validation of process models aimed at repository performance assessment.

4.10 Sealing of Tunnel at Great Depth

Background

Although the repository facility will be located in rock mass of good quality with mostly relatively low fracturing, control of the groundwater will be necessary. The measures to control groundwater will include the sealing of fractures that are conducting groundwater, and may also include local draining or waterproofing as well as infiltration of water. Sealing will be achieved by means of grouting, which means filling the water-conducting fractures with grout so that the permeability of the rock mass close to the tunnel or rock cavern is reduced.

Experience from the grouting of road- and railroad tunnels shows that ordinary grouts based on cement cannot penetrate very fine fractures. Further, from a long-term safety view-point, a sealing agent that produces a leachate with a pH below 11 is preferred. Silica sol, which consists of nano-sized particles of silica in water, has shown to be a promising grout. When a salt is added to the sol, a gel is formed. The concentration of the salt determines the gelling time and thus the grouting can be controlled. However, the use of silica sol under high water pressures has to be tested and equipment and grouting designs evaluated.

Another issue for the planned repository is the contour and status of the remaining rock after blasting. The rock is a natural barrier in the KBS-3-system and further KBS-3 includes a backfill with a defined density in the repository rock openings. In order not to unnecessarily disturb the natural barrier (the rock mass) and to provide good conditions for the engineered barrier (the backfill), the resulting rock wall has to be smooth and the fracturing induced by blasting in the so called excavation damaged zone (EDZ) has to be limited.

Objectives

The main goals of the project is to confirm that silica sol is a useful grout at the water pressures prevailing at repository level, and to confirm that it is possible at this water pressure to seal to the preliminary tightness requirement for a deposition tunnel. The project also has to show that it is possible to fulfil the demands related to blasting of the tunnel.

Experimental concept

To achieve the above mentioned objectives, SKB constructs the Tass-tunnel at the –450 m level in Äspö HRL. Execution is step-wise and includes grouting with ordinary grouting fans outside the contour, grouting with grout holes inside the contour and post-grouting. Low-pH cementitious grout is also tested. The project implements and evaluates grouting characterisation methods and grout spread models as developed by Chalmers.

The requirements related to blasting are to minimise the EDZ, and that the resulting contour after blasting should follow the theoretical with very small deviations, to allow for efficient and controlled backfilling. Special attention is therefore given to drilling and blasting. The results are followed and evaluated closely and subsequent adjustments made.

To be able to evaluate the EDZ through direct observation of the fractures induced by blasting, the project also includes the excavation of rock blocks from the tunnel wall. The blocks are divided in 0.1 m thick slices in order to examine the character of the EDZ.

Results

Following the results, the execution of works with implementation of different fan geometries has been altered compared to the original set-up. The tunnel has now reached its final length 80 meters. It includes two full grouting fans outside the contour (fans 2 and 3) and three fans inside the contour (fans 4, 5 and 6), see Figure 4-25.

The inflow as encountered in core drilled holes in the pre-investigations, had peaks around 40, 25 and 50 L/minute at sections 20 m, 55 m and 75 m respectively. The requirement is to achieve an inflow that is limited to 1 L/ 60 meter and minute, or less. The inflow limit is distributed corresponding to the length of the section, so that e g the acceptable inflow for the 24 meter long section along fans 2 and 3 is 0.4 L/minute. In the tunnel, weirs are built at sections 10 m, 34 m, 50 m and 78 m and inflow measurements are carried out, see Figure 4-26. The measurements show that the requirement on tightness is fulfilled along fans 2 and 3 (0.3 litres, section 10–34 m), as well as along fans 5 and 6 (0.4 litres, section 50–78 m), whereas the inflow is too large along fan 4 (0.8 litres, section 34–50 m). Both silica sol and low-pH grout based on cement have been used in the sealing operations.

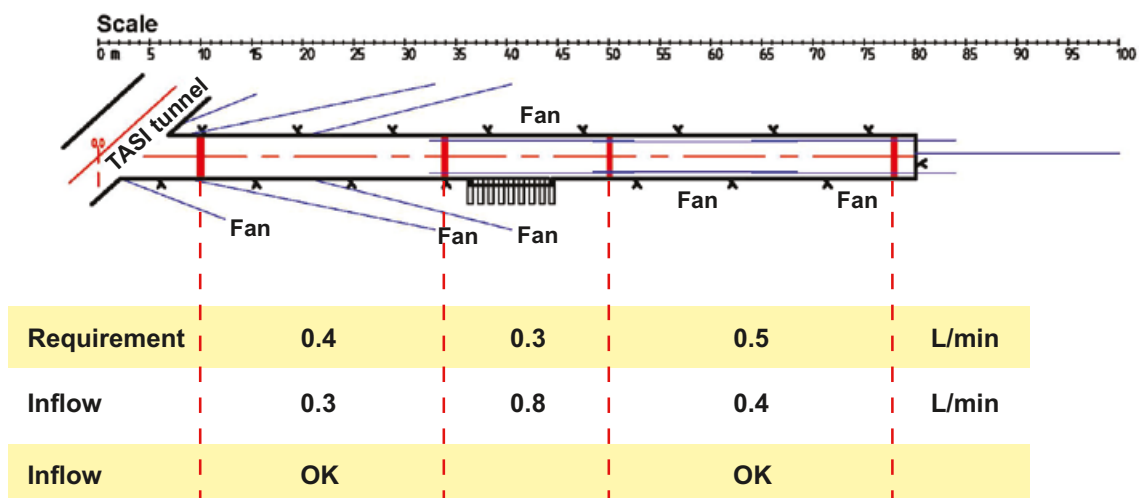

Figure 4-25. The Tass-tunnel fans, measuring weirs and inflows. Post grouting is planned for the middle section.



Figure 4-26. A lot of effort is given to the measurement of the inflow to the tunnel. Here, a measuring dam, a so called weir. The dam is filled with water in order to get an outflow from the dam that is stable. Photo: Magnus Kronberg.

Thus, the major project goal has been achieved, to show that it is possible to limit the inflow to less than 1 L/ 60 meter and minute in a tunnel at deposition depth, using grouts that are suitable for the final repository. This has been possible with ordinary grouting fans with grouting holes outside the tunnel contour, as well as with holes inside of the tunnel contour only.

What remains is to attempt to reach the inflow limit along fan 4 by means of post grouting. A special post grouting difficulty is the high water pressure gradient, that has to be considered in order not to get erosion of the grout and that will tend to force the grout back in to the tunnel. In this case, the EDZ blocks extraction with boreholes reaching out 2.5 m into the rock mass at section 36–44 means special geometrical difficulties.

During grouting the reduction in inflow between the successive grouting rounds has been followed by inflow measurements in the control holes. A reduction of the transmissivity of the rock mass with a factor of up to 1,000 has been indicated.

The work with planning, preparation, follow-up and feedback during the rounds has contributed a lot to the improvement and the result of the rock excavations.

The scanning result for the contour section 21–49 m shows that the overbreak is about 15% which fulfil the requirement $< 30\%$ from the backfilling. The test with different look out angles of the blasting holes shows that 25 cm is manageable, less is possible but increases the risk for underbreak and it also slows down the process.

The 78 slices for the evaluation of EDZ show that the fractures induced by blasting in the bottom charge of the blasting hole are 0.3–0.4 m long in radial direction and less than 1 m in axial direction. The result also shows that the fractures induced by blasting are not connected from round to round, and therefore there is no continuous EDZ along the tunnel.

4.11 In situ Corrosion Testing of Miniature Canisters

Background and objectives

The evolution of the environment inside a copper canister with a cast iron insert after failure is of great importance for assessing the release of radionuclides from the canister. After failure of the outer copper shell, the course of the subsequent corrosion in the gap between the copper shell and the cast iron insert will determine the possible scenarios for radionuclide release from the canister. This has been studied experimentally in the laboratory and been modelled. In this project miniature copper canisters containing a cast iron insert will be exposed for several years in boreholes in the Äspö HRL. Defects have been deliberately introduced into the outer copper shell so that evolution of corrosion inside the canisters can be investigated. The corrosion will take place under reducing, oxygen-free conditions in the presence of microbial activity present in the groundwater; such conditions are very difficult to create and maintain for longer periods of time in the laboratory. Consequently the in situ experiments at Äspö HRL will be invaluable for understanding the development of the environment inside the canister after initial penetration of the outer copper shell.

The main objective of the work is to provide information about how the environment inside a copper canister containing a cast iron insert would evolve if failure of the outer copper shell were to occur. This is important because the development of corrosion products in the gap between the copper shell and the cast iron insert could affect the rate of radionuclide release from the canister. The results of the experiment will be used to support process descriptions and safety analyses. The following specific issues are being addressed:

- Does water penetrate through a small defect into the annulus between the cast iron insert and the outer copper canister?
- How does corrosion product spread around the annulus in relation to the leak point?
- Does the formation of anaerobic corrosion product in a constricted annulus cause any expansive damage to the copper canister?
- Is there any detectable corrosion at the copper welds?
- Are there any deleterious galvanic interactions between copper and cast iron?
- Does corrosion lead to failure of the lid on the iron insert?
- Are there any effects of microbial corrosion on the canister?
- What are the corrosion rates of cast iron and copper in the repository environment?
- What is the risk of stress corrosion cracking of the copper?

Experimental concept

Miniature canisters with a diameter of 14.5 cm and length 31.5 cm have been set up in five boreholes with a diameter of 30 cm and a length of 5 m. The model canister design simulates the main features of the SKB canister design. The cast iron insert contains four holes simulating the fuel pin channels, together with a bolted cast iron lid sealed with a Viton O-ring. The copper lid and base are electron beam welded to the cylindrical body. The annulus between the cast iron insert and the outer copper body is <30 µm wide. All the canisters have one or more 1 mm diameter defects in the outer copper shell, in a range of different orientations. The canisters are mounted in electrically insulated support cages (Figure 4-27), which contain bentonite clay of two different densities. There is no direct electrical contact between the copper canister and the stainless steel support cages. One experiment does not contain any bentonite, to investigate the direct effect of raw groundwater on the corrosion behaviour. Cast iron and copper corrosion coupons are mounted inside the support cages of each experiment and corrosion behaviour is monitored electrochemically. Cast iron and copper weight loss specimens are also present. Each support cage contains a 'sandwich type' copper-cast iron specimen to investigate oxide jacking effects and galvanic corrosion. U-bend and wedge open loading stress corrosion specimens are mounted in one of the boreholes in direct contact with the groundwater, to assess the possible risk of stress corrosion cracking of copper. In addition, two of the canisters will be monitored using strain gauges to monitor any expansion effects. The redox potential, Eh, is being monitored using a combination of metal oxide, platinum and gold electrodes. The experiments are located where there are many fractures around the boreholes, leading to a plentiful supply of natural reducing groundwater to the experiments (Figure 4-28).

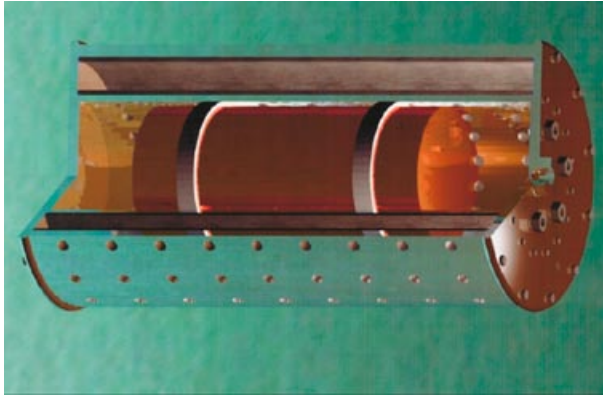

Figure 4-27. Design of model canister experiment showing copper canister in support cage.



Figure 4-28. Installation of model canister experiment.

The experiments are continuously monitored to measure the following parameters:

- Corrosion potential of the model canister, cast iron and copper.
- Electrochemical potential of gold, platinum and a mixed metal oxide Eh probe.
- Corrosion rate of cast iron and copper, using linear polarisation resistance, AC impedance and electrochemical noise.
- Strain on the surface of two of the model canisters.

Regular water samples are taken from within the support cages to monitor the development of the local chemistry. The experiments will remain in situ for several years, after which they will be dismantled and the evolution of the corrosion front inside the canister will be analysed.

Results

During 2008, monitoring of the miniature canister experiments has continued. Data are being collected for corrosion rate of copper and iron electrodes, and electrochemical potentials for a range of electrodes, including Eh, iron and copper. In addition, strain gauge data are being collected for two of the canisters. Water analysis, including analysis of gases and microbial content of the water, was carried out up to autumn of 2007. A further campaign of water analysis was performed in the autumn of 2008. The results up to May 2008 have been compiled in to a report, which is due to be published as an SKB report. The results obtained during the second half of 2008 are currently being analysed and will be reported in 2009. Consideration will also be given to removal of one experiment in order to examine the extent of corrosion.

The highlights of the project to date are as follows:

- The model canister experiments have been successfully set up and collection of the expected types of data is proceeding according to plan. Failure of some of the reference electrodes has occurred, but built in redundancy has enabled the experiments to continue.
- Water analyses have shown an increased concentration of iron and a decrease in pH inside the support cages, which may be associated with microbial activity (particularly by sulphate reducing bacteria) affecting the corrosion rate of iron-based materials in the experiment (i.e. cast iron and/or stainless steel).
- The measured Eh values are compatible with published literature values and show a fall in Eh with time as any residual oxygen is consumed, this is confirmed by dissolved gas analysis.
- The electrochemical corrosion rate measurements of the copper electrodes are compatible with published literature, but they need to be confirmed by weight loss measurements when the experiments are dismantled.

4.12 Cleaning and Sealing of Investigation Boreholes

Background and objectives

Investigation boreholes are drilled during site investigations and detailed characterised in order to obtain data on the properties of the rock. These boreholes must be sealed, no later than at the closure of the final repository, so that they do not constitute flow-paths from repository depth to the biosphere. Hence, the sealed boreholes must have a hydraulic conductivity that does not exceed that of the surrounding rock.

A project dealing with identifying and demonstrating the best available techniques for cleaning and sealing of investigation boreholes was initiated in 2002 and up to now Phase 1 to 3 have been finalised. Phase 4 of the project has two sub-projects:

1. Characterisation and planning of borehole plugging.
2. Performance and quality assessment.

The specific goal of sub-project 1 is to characterise and plan plugging of boreholes so that the impact of the seals on the overall hydraulic performance of the repository rock can be evaluated. The work is confined to deal with certain “reference holes” as a basis of development of a general programme for planning and realising of borehole plugging, considering also cost issues. The work principle for selection of holes is the following:

- to identify several candidate boreholes for selecting a few reference boreholes in the study of how they can interfere with a repository and of how they can be sealed,
- to make a first simple estimate of the overall function of plugs separating permeable fracture zones. This would indicate how important plugs really are for sealing off boreholes,
- to estimate the flow rate of water from a selected imaginary repository through selected boreholes passing through the repository, in which a certain heat-generated water overpressure is assumed to prevail, to the nearest large fracture zone,
- to estimate if partial or complete loss of sealing potential of borehole plugs plays a practically important role. This will make it possible to determine if the plugs need to be of high quality or if sufficiently effective but simple and cheap plugging techniques can be applied.

The aim of sub-project 2 is to work out a general model of location and design of seals in boreholes. This requires investigation of how boreholes should be prepared for sealing with respect to required stability, geometry and hydraulic conditions. This work includes identification of borehole properties of particular importance for the isolating function of borehole seals, on a small as well as large scale. The work will also include assessment of costs for different sealing attempts, considering practicalities, long-term performance and quality assurance (QA) and quality control (QC) issues. The latter should involve assessment of the consequences of poorly performed seals. Major issues are: (1) definition and quantification of the required degree of tightening of different parts of deep boreholes and holes bored from galleries, based on their hydraulic function in the respective rock structure model, (2) Attempt to work out generalised principles for selecting suitable, cost-effective borehole seals, (3) Cost estimation and (4) QC/QA assessment of sub-systems and of the integrated plug system.

The basic principle selected for borehole sealing is to tightly seal those parts of boreholes where the rock has few fractures and a low hydraulic conductivity, and to fill the parts that intersect permeable fracture zones with physically stable material that does not need to be very tight. The latter zones are those with a potential to undergo tectonically induced strain and plugs placed in them and one needs to consider that they may be exposed to repeated large strain that will affect the sealing potential.

Results

The work performed in 2008 has mainly concerned sub-project 1. The selection of candidate holes was based on the following premises:

- at least three deep holes for each of the Forsmark and Laxemar sites must be identified for subsequent selection of reference holes in the planned detailed study of the function of seals. The holes must be well characterised with respect to the nature and location of intersected fracture zones and of the borehole constitution (diameter variation, straightness, inflow/outflow of water),

- one sub horizontal hole of 50 to 100 m length extending from the Äspö HRL should be selected for later investigation of how sealing can be made where very high hydraulic gradients prevail. The hole must be characterised in the same way as the deep ones,
- the holes should represent typical conditions of the respective site,
- one candidate hole at each site should be appointed “reference” hole and used in the project.

Examination of maps and sections showing the location of major fracture zones led to the conclusion that of the 43 boreholes at Forsmark and Laxemar made with depths up to 1,200 m, can be taken as candidate holes in the project. The basis of this decision was that the length should exceed 500 m and that several major fracture zones should be intersected. Based on the specified conditions KFM07A, KFM04, KFM09A and KFM09B at Forsmark and KLX06, KLX10 and KLX4 at Laxemar were identified as candidate holes.

The most important role played by boreholes reaching deep down into the repository rock or extending from the repository is to serve as a migration path for radionuclides to the biosphere. This means that the major fracture zones that are intersected by the holes and the mutual hydraulic interaction of the zones are of primary interest. They are illustrated in Figure 4-29 for boreholes in Forsmark.

The decision to take only one of the candidate holes at each site as reference hole for the study has required formulation of an appropriate basis of this selection. For this purpose the following criteria have been applied:

- assessment of the importance of the holes before and after sealing with respect to the hydraulic function, the major parameter being the frequency of intersected zones,
- assessment of the importance of expected difficulties in performing stabilisation and plugging (water inflow and unstable rock),
- consideration of the representativeness of the boreholes (“typical” few fracture zones and “extreme” frequent fracture zones),
- estimated importance of hydraulic short-circuiting of fracture zones.

Considering the most important criteria, i.e. those respecting hydraulic conditions and frequency of intersected fracture zones the two holes KFM07 at Forsmark and KLX06 at Laxemar were appointed reference holes.

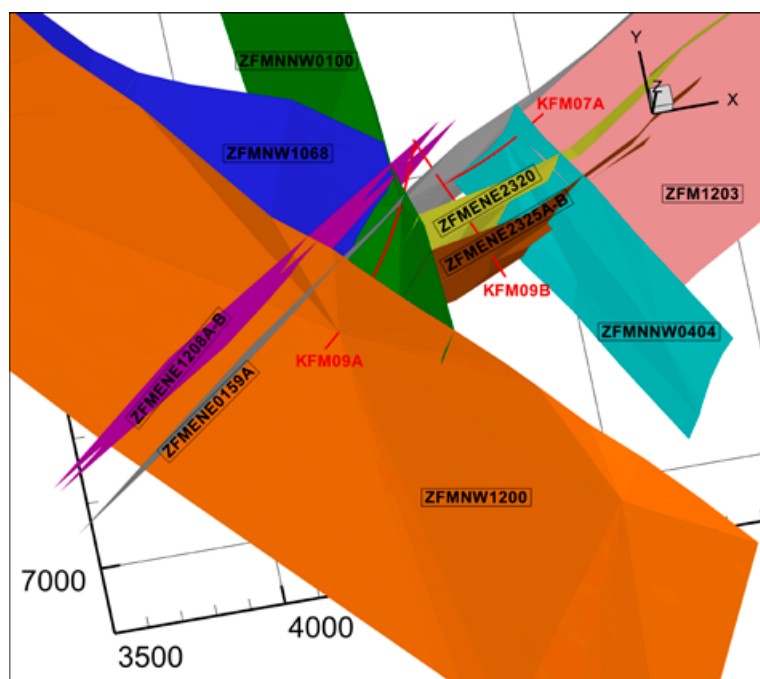

Figure 4-29. Parallel perspective view of Forsmark rock with the three boreholes KFM07A, KFM09A and KFM09B. KFM07A intersecting several major fracture zones.

Impact of borehole geometry

The borehole geometry is of great practical importance for the following reasons:

- small curvature of the holes means that long plug units may get stuck or require axial force to push them down,
- the diameter determines the dimensions and density of the clay plugs. Thus, 56 mm diameter gives lower density than 76 mm, which is in turn lower than for 90 or 100 mm diameter. The plug diameter is determined by the smallest hole diameter,
- irregular wall surfaces mean that there is a risk that tubes for placing “basic” and “container”-type clay plugs and for casting concrete may be stuck if the lower edge hits the wall.

Measurement of the borehole shape has given the basis of evaluation of the curvature of the holes. Taking the length of clay plugs as 12 m, the critical deviation from an assumed straight axis would be about 4 mm over this length, corresponding to a radius of curvature of about 4,000 m, which is fulfilled by several but not all of the examined holes, but any local sharper bend would imply that the tube is in contact with the borehole walls at its ends. The sensitivity of the curvature is hence such that very careful characterisation of the shape of the borehole is required.

Calliper measurements for borehole KFM04 at Forsmark has been made. The diameter varies between 76 and 78 mm over the larger part with widening to 78–80 mm over about ¼ of the total length and locally to 80–82 mm. One concludes from available data that there may be considerable deviations from the intended diameter and smoothness of the boreholes and that one has to further investigate the actual variations in diameter and topography of the borehole walls for drawing safe conclusions of how they can affect the density and tightness of clay plugs.

Proposed plug positions

Taking the two holes KFM07 at Forsmark and KLX06 at Laxemar as reference holes suitable plug types and positions have been identified. The principle followed is to construct clay plugs in tight rock and concrete where fracture zones are intersected. However, for practical reasons some generalisation is made, mostly implying that concrete is placed where the spacing of fracture zones is very small.

4.13 Task Force on Engineered Barrier Systems

Background and objectives

The Task Force on Engineered Barrier Systems is a natural continuation of the modelling work in the Prototype Repository project. Modelling work on other experiments, both field and laboratory tests, are also conducted. The Äspö HRL International Joint Committee (IJC) decided that in the first phase of this Task Force (period 2004–2008), work should concentrate on:

- THM modelling of processes during water transfer in buffer, backfill and near-field rock. Only crystalline rock is considered in this phase.
- Gas transport in saturated buffer.

All defined tasks are given in Table 4-3. The objectives of the Tasks are to: (a) verify the capability to model THM and gas migration processes in unsaturated as well as saturated bentonite buffer, (b) refine codes that provide more accurate predictions in relation to the experimental data and (c) develop the codes to 3D standard (long term objective).

Participating organisations besides SKB are at present: Andra (France), BMWi (Germany), CRIEPI (Japan), Nagra (Switzerland), Posiva (Finland), NWMO (Canada) and RAWRA (Czech Republic). All together 12–14 modelling teams are participating in the work.

Table 4-3. Modelled tests in the Task Force on Engineered Barrier System.

Benchmark 1 – Laboratory tests

Task 1 – THM tests

- 1.1.1 Two constant volume tests on MX-80 (CEA)
- 1.1.2 Two constant volume tests on Febex bentonite – one with thermal gradient and one isothermal (Ciemat)
- 1.1.3 Constant external total pressure test with temperature gradient on Febex bentonite (UPC)

Task 2 – Gas migration tests

- 1.2.1 Constant external total pressure (BGS)
 - 1.2.2 Constant volume (BGS)
-

Benchmark 2 – Large scale field tests

Task 1 – URL tests (AECL)

- 2.1 Buffer/Container Experiment and Isothermal Test

Task 2 – Äspö HRL test (SKB)

- 2.2 Canister Retrieval Test
-

Since these tasks do not include geochemistry, a decision was taken by IJC to also start a parallel Task Force that deals with geochemical processes in engineered barriers. This Task Force was initiated at the end of 2006 and during 2007 SKB (Clay Technology), Nagra (University of Bern) and Posiva (VTT) has participated and in 2008 the geochemical Task Force was also joined by Andra. The two Task Forces have a common secretariat (Clay Technology) but separate chairmen (THM/Gas: A. Gens, UPC and Geochemistry: Urs Mäder, University of Bern).

Results

Two Task Force meetings have been held during 2008; one in Äspö HRL in May and one in Hergiswil (Switzerland) in November. For information about performed work within the different tasks by the international organisations, see Chapter 7.

THM/Gas

Benchmark 1 – Laboratory tests

The modelling of Benchmark 1 (Tasks 1 and 2) was finished and reported in 2007. A summary report of Task 1 will be published in 2009.

Benchmark 2 – Large scale field tests

Task 1 (modelling of the Buffer/Container Experiment and the Isothermal Test) has been finished during 2008 and results have been presented at the meetings. Many modelling teams could get good results by changing parameter values, especially the retention curve of the buffer and the properties of the rock, but not for both the laboratory tests and the field tests with the same parameters (unless using different approaches like a “cluster model”). Final reports will be delivered in the beginning of 2009 and final evaluation of the results presented at the next meeting.

Task 2, that concerns modelling of the Canister Retrieval Test at Äspö HRL, has been the main modelling object during 2008. Altogether 8 modelling teams are working with this Benchmark. The task is divided into two parts where the first part is to model the thermo-hydro-mechanical behaviour of a central section of the test hole with given boundary conditions. The second part is to model the whole test. Most teams have finished the first part and are continuing modelling the entire test. The status of the calculations was presented at the Task Force meeting in Hergiswil in November. The modelling work will continue during 2009.

A new task for future modelling was suggested. This task is common with the Groundwater Task Force and focuses on the hydraulic interaction between the rock and the bentonite. SKB has decided to support such a test, which will be installed at Äspö HRL. The final proposal of the test is currently scheduled for May 2009.

Geochemistry

The geochemical part of the Task Force has identified the need to adjust existing general geochemical modelling tools in order to successfully apply them to bentonite modelling – the intricate electrochemical characteristics of water-saturated bentonite must be considered. Two intermediate meetings with only the geochemistry group were organised at Clay Technology in Lund during 2008 in order to discuss and develop existing models. A conceptual model concerning the influence of concentration discontinuities on ion transport in bentonite was presented by the CT group as well as a number of small scale laboratory experiments.

Modelling efforts, mainly by use of the PhreeqC modelling tool, concerning the Lot experiment have been performed and presented at the regular EBS TF meetings. Results from the small scale laboratory experiments have been distributed as common benchmark modelling exercises.

In parallel to the ongoing geochemical modelling and model development, molecular dynamics (MD) simulations of montmorillonite have been performed at Clay Technology. Using this technique, self diffusion coefficients of water and ions have been calculated for different water ratios and compared with those obtained from neutron scattering experiments. During 2008 the major MD simulation effort has been to investigate the so called Donnan equilibrium of Na-montmorillonite at high bulk clay density in contact with external NaCl solutions of various concentrations. This study demonstrates at the molecular level that chloride ions as well as external sodium ions enter the inter-layer space to approximately the extent predicted by the equation for Donnan equilibrium. This study was completed during Christmas and the results will be submitted for publication during spring 2009. Initial steps toward an improved interaction potential for the edge sites of the montmorillonite layer have been completed in terms of quantum mechanical density functional theory calculations. This new interaction potential will be used in MD simulations aimed at further elucidate water diffusion in montmorillonite.

Furthermore, using MD, accurate counter ion density profiles in montmorillonite have been calculated. These have been used to quantify the validity range of analytical continuum expressions (using the Poisson-Boltzmann equation) and are a key ingredient for understanding the very different chemico-mechanical behaviour of sodium, caesium and calcium montmorillonite as well as mixed sodium/calcium montmorillonite.

5 Äspö facility

5.1 General

The Äspö facility comprises both the Äspö Hard Rock Laboratory and the Bentonite Laboratory. Important tasks of the Äspö facility are the administration, operation, and maintenance of instruments as well as development of investigation methods. The Public Relations and Visitor Services group is responsible for presenting information about SKB and its facilities. They arrange visits to the facilities all year around as well as special events.

5.2 Bentonite Laboratory

Background and objectives

Before building a final repository, further studies of buffer and backfill under different installation conditions are required. SKB has therefore built a Bentonite Laboratory at Äspö designed for studies of buffer and backfill materials. The laboratory has been in operation since spring 2007. The Bentonite Laboratory enables full-scale experiment under controlled conditions and makes it possible to vary the experiment conditions in a manner which is not possible in the Äspö HRL.

The laboratory, a hall with dimensions 15×30 m, includes two stations where the emplacement of buffer material at full scale can be tested under different conditions. The hall is also used for testing of different types of backfill material and the further development of techniques for the backfilling of deposition tunnels.

Results

The laboratory has been in full operation during 2008. Different methods and techniques for installation of pellets and blocks in deposition tunnels, tests on piping and erosion of buffer and backfill material, and backfilling the bevel of the deposition hole have been performed. During autumn 2008, tests concerning the impact of water inflow on buffer and backfill have been priority. The question is how much water inflow in deposition tunnels that can be accepted and how the selection of material influences the extent of piping and erosion.

A number of tests with varying inflow to the backfill have been performed. The tests and the results have given a better understanding of the course of events in the backfilling. A test set-up before and after interruption and excavation is shown in Figure 5-1. The results (e.g. time for water breakthrough, eroded material and input of water) from the tests are preliminary showing that erosion does not control the speed of the backfilling process. The test results show that spot wise inflow of up to 0.5 L/min may be acceptable with respect to the erodability of the backfill. However, such high inflows will most probably require special means of discharging water and mud that reach the front. Today, there is no such technique but there are plans to work out methods for solving the problem. At present, spot wise inflow of more than about 0.25 L/min can not be handled unless the rate of backfilling is higher than the rate of water migration in the backfill. The backfilling rate depends on the method employed for emplacing the materials. Next series of tests will be performed with the reference material Milos B, focusing on course of events before breakthrough at the front. After that, tests underground in the tunnel will be performed, where the rock contour and its influence will be taken into consideration.

A series of experiments to study the water inflow to the buffer is ongoing, see Figure 5-2. The aim of the tests is, amongst other, to control axial expansion of the buffer. The tests are done with an installation above the buffer simulating the counter pressure from the backfilling. Different amount of water inflow is used and the eroded material is measured.

Compaction of backfill material in the bevel towards the deposition hole has to be done so that high bearing capacity is achieved. If the backfill block sinks down in the material above the bevel, problems with stability in the pile of blocks can be expected and hence problems to reach the required backfill density. Tests concerning compaction methods and different materials have been performed. Preliminary results from the tests shows that it is possible to compact material to sufficient density so the blocks above the bevel will be stable and not sink down more than the block placed above the buffer, see Figure 5-3. Work is still needed to develop methods and techniques for backfill, especially to demonstrate that backfill is possible at full scale.



Figure 5-1. Test set-up in half-scale before (left) and at excavation (right).



Figure 5-2. Buffer test with regards to influence by water inflow.



Figure 5-3. Stacking tests on backfilled bevel and buffer.

5.3 Facility operation

Background and objectives

The main goal for the operation of the rock laboratory is to provide a facility which is safe for everybody working in, or visiting it and for the environment. This includes preventative and remedial maintenance in order to ensure that all systems such as drainage, electrical power, ventilation, alarm and communications are available at all times in the underground laboratory.

Results

The hard rock laboratory has exceeded its goal of 98% availability and no unplanned interruptions occurred during 2008. During 2008 SKB's own personnel took over the maintenance of the facility from Oskarshamn NPP. Planned maintenance of the elevator cage, which limited access to the facility, was carried out during the summer and further maintenance to the facility has been carried out according to plan. In order to ensure a continual electricity supply underground, a reserve power cable has been installed in the elevator shaft.

The automatic registration system is now in operation and is being used in parallel with the manual system. During the year, the system has worked well, but the users require additional functions, which for now are being carried out by the manual system. Therefore, the manual system is still operational. When additions are made to the automatic system, the documentation and routines must be rewritten.

The increased activities at Äspö require more space and new premises. An archive has been built and the office space has been increased by nine new workplaces as a result of fitting out the loft space of the building which houses the changing-rooms. The decision to build a canteen for SKB personnel was taken during the summer. Planning and contracting the building of a canteen was carried out during the autumn and the work will be finished before summer 2009. The parking space at Äspö laboratories has been extended with the waste rock from the excavation of the tunnel for the project Sealing of Tunnel at Great Depth. SKB also has to take a greater responsibility for road maintenance, which is organised by the local road association. The road has been asphalted during the year.

The planned waste-water pipe, which will be placed in the sea, has been delayed due to the time taken to reach an agreement with the owners of fishing rights. Hopefully, the work can be carried out during 2009.

5.4 Public Relations and Visitor Services

Background and objectives

The main goal for the Public Relations and Visitor Services Group is to create public acceptance for SKB, which is done in co-operation with other departments at SKB. The team is responsible for visitor services at Äspö HRL, the Central interim storage facility for spent nuclear fuel (Clab) and the Canister Laboratory. The information group has a special booking team at Äspö HRL which books and administrates all visitors. The booking team is also at OKG's service according to agreement. As from autumn 2008 the team also has the responsibility for the production of SKB's exhibitions; stationary, temporary and on tour.

During 2008, the three facilities in Oskarshamn and the site investigation activities in Oskarshamn were visited by 14,177 persons. The visitors represented the general public, municipalities where SKB perform site investigations, teachers, students, politicians and journalists. The number of visiting politicians (606) has more than doubled compared to 2007. In addition, the information group takes care of and organises visits for a great amount of foreign guests every year. The visits from other countries mostly have the nature of technical visits and the total number of foreign visitors 2008 was 1,470. The total number of visitors to all SKB facilities and site investigation activities in Oskarshamn and Forsmark was 24,133, see Figure 5-4.

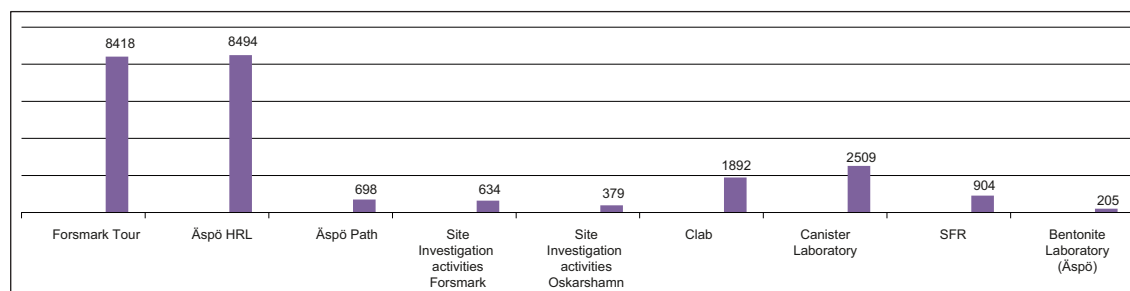

Figure 5-4. The number of visitors to the different SKB facilities during 2008.

Special events

In 2008 the following special events took place:

- A series of lectures with special connection to the research and development of techniques conducted at the Äspö facility started in 2007 and has continued during 2008. “The Environmental Day” at Äspö, was held on the 3rd of April in cooperation with Äspö Environmental Research Foundation and was a contribution to the environmental week in Oskarshamn. The theme was the future threat of climate changes and what that means for a final repository. The conference during the day and lectures for the general public in the evening attracted 150 persons.
- The guided summer-tours “Urberg 500” started in the end of June and ended the 17th of August. During two weeks there were no guided tours offered due to maintenance work. Even though, the number of visitors was 2,428 persons and the goal for 2008 (2,300) was reached.
- The “Geology Day” the 12th–13th of September and the activities organised during the national event attracted about 150 visitors. The public as well as students were invited to two separate geological trips to the island Öland. The theme for the local events was to show differences between disparate kinds of rock and what kind of rock is suitable for a deep geological repository.
- On the 26th of September a contribution to EU’s Researchers’ Night (RIE) was held at Äspö, with the celebration of the 25th anniversary of the KBS-3 method in focus. The RIE initiative allows citizens to get closer to our researchers and gives a face to European research. Three barriers were represented by researchers at SKB. The main purpose was to create interest for research from students and the general public. The event attracted about 80 persons.
- On November 19th an inauguration event was held at Äspö HRL. A ceremony was held in the tunnel to celebrate a new canister deposition machine. Local papers, magazines and television participated. In addition, tours and information were given during the day.
- A contribution to “Oskarshamn in Light” was held at Äspö on the 6th of December. The event consisted of a light-and-music-show down in the underground laboratory and 85 people took the chance to visit Äspö at the same time.
- The Äspö Running Competition took place on the 13th of December and attracted 80 runners. This event has been a tradition for ten years and the number of participants set a new record.

6 Environmental research

6.1 General

Äspö Environmental Research Foundation was founded 1996 on the initiative of local and regional interested parties. The aim was to make the underground laboratory at Äspö and its resources available for national and international environmental research. The activities have since 2003 been concentrated to the Äspö Research School. SKB and Äspö HRL have a general policy to broaden the use within the society concerning research results, knowledge and data gathered within the SKB research programme. When the activities in the school was concluded as planned in 2008, the remaining and new research activities were transferred within the frame of a new co-operation, Nova Research and Development (Nova FoU).

Nova FoU is a joint research and development platform at Nova Centre for University Studies Research and Development. The platform is supported by SKB and the municipality of Oskarshamn. Nova FoU is the organisation that facilitates external access for research and development projects to SKB facilities in Oskarshamn and at Äspö HRL. Nova FoU can co-finance the projects by valuing the access to the SKB facilities, knowledge and data.

The aim with the research and development projects through Nova FoU is to create long term spin-offs and business effects beneficial to the region. Nova FoU supports new and innovative research, for example environmental studies, where the extensive SKB data set from geological, hydrogeological, hydrogeochemical and ecological investigations and modelling can be used, see Figure 6-1.

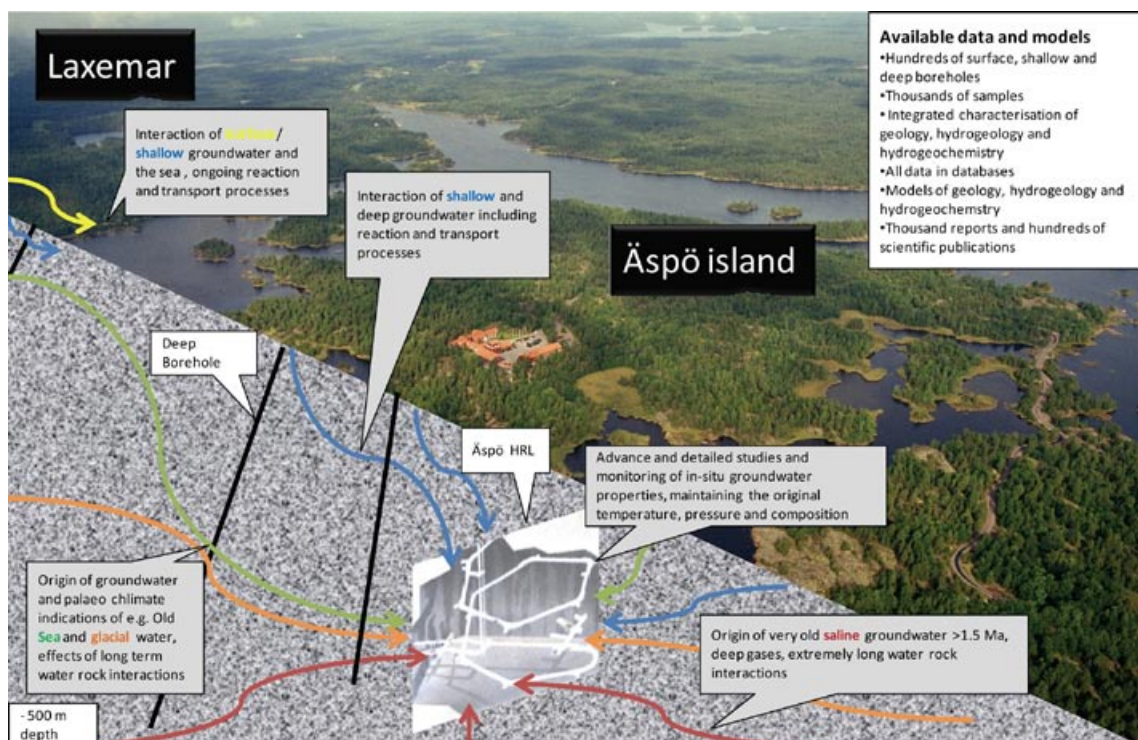

Figure 6-1. The Äspö and Laxemar areas have been studied in terms of geology, hydrogeology, hydrogeochemistry and ecology.

The data can be used e.g. for assessing the consequences of natural resource management and pollution risks. The data and models can be used to estimate exposure both at individual and population levels. Development of monitoring and analytical systems can be performed relating to the management of various renewable natural resources in, for instance, agriculture, fisheries, forests and groundwater. Studies which give a better knowledge concerning pollution problems coupled to toxicological and epidemiological issues are possible. Technology, innovations and spin-off effects at pre-market stages are of special interest. Other possible studies are:

- Groundwater origin, mixtures and evolution.
- Interaction between large depths, surface and sea.
- Model and technology development.
- Tunnel and borehole experiments.

Ongoing research and development projects at Nova FoU:

- Microbial research: Exploration of the intra-terrestrial geogas-driven biosphere.
- Coastal systems: Advanced studies of interactions between land and sea.
- Development of software and hardware: 3D radio frequency identification (RFID) of persons and objects in underground environment.
- Research and education: Geochemistry Research Group is the most matured activity within Nova FoU and is therefore described in more detail in the section below.

6.2 Geochemistry Research Group

The Geochemistry research group at Äspö HRL is a project within the research platform Nova FoU. The group consists of a professor, a post doc and three Ph.D. students. Focus is on research of chemical elements in soil, water, bedrock fractures and biota, and includes detailed studies of how elements are distributed in streams and groundwater at various depths. The research includes field monitoring, laboratory work and modelling.

The research projects are funded by Kalmar University, SKB and Knowledge Foundation (KK-Stiftelsen). During 2008 a new project on the topic hydrochemistry of deep groundwaters in Äspö, Laxemar and Forsmark was started. The focus is on repository depth, and includes modelling (M3, PhreeqC) of existing data of major anions and cations and some isotopic variables. The time schedule is 2008–2012. A total of four sub-projects were completed in 2008 and these are:

- *Uranium in surface and groundwaters in Boreal Europe*. This sub-project has explored the distribution patterns and controls of uranium in boreal surface water, groundwater and brackish (Baltic Sea) water. Data from Äspö, Laxemar and Forsmark were used in combination with a number of other existing data sets in order to highlight the aqueous behaviour of this metal in northerly regions. The study has been published in *Geochemistry: Exploration, Environment, Analysis*.
- *Niobium in boreal stream waters and brackish-water sediments*. This sub-project has explored the distribution patterns and controls of niobium in boreal stream waters and brackish-water sediments. Data from Laxemar and Forsmark were used in combination with a number of other existing data sets in order to assess the major features of this metal, which also has radioactive isotopes existing in nuclear waste, see Figure 6-2 and Figure 6-3. The study has been published in *Geochemistry: Exploration, Environment, Analysis*.
- *High K/Rb ratios in stream waters – exploring plant litter decay, groundwater and bedrock as potential controlling mechanisms*. This sub-project has explored the potential controls of potassium/rubidium (K/Rb) ratios in surface and groundwaters, which normally are considerably higher than the corresponding ratios in solid materials (mineral, soil, bedrock). Data from Laxemar and Forsmark were used in combination with a number of other existing data sets. A major conclusion was that in contrast to what has been previously suggested, the K/Rb ratio is more strongly controlled by geochemical and hydrochemical mechanisms than biogeochemical (litter decay) processes. The study has been published in *Chemical Geology*.

- *Trace metals in recharge and discharge groundwater at two geochemically contrasting sites.* The project has explored the distribution patterns and controls of trace metals in overburden groundwaters in Laxemar and Forsmark. Data from the site investigations, including temporal hydrochemical data from a large number of groundwater tubes in both areas, were interpreted and analysed by means of statistical methods. Large variations existed, among the trace metals, both between recharge and discharge areas and between the two sites. The study has been published in *Applied Geochemistry*.



Figure 6-2. *A stream in Laxemar, which has been monitored for several years, including determination of hydrological, hydrochemical and hydrophysical variables.*

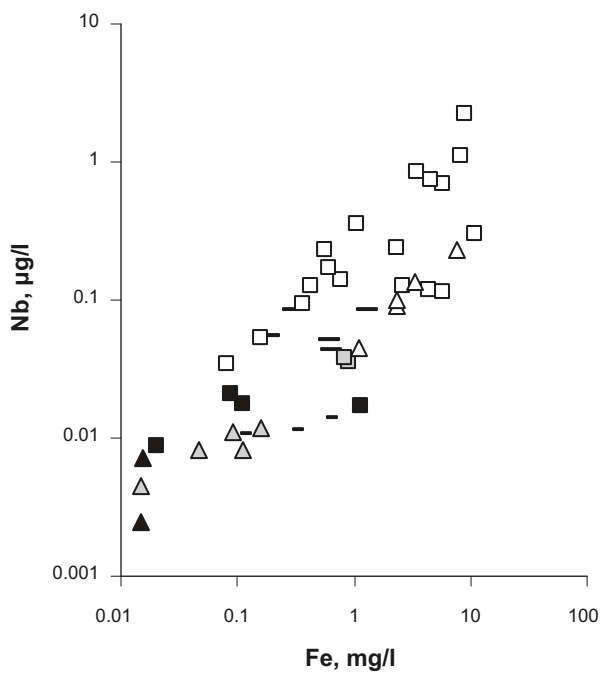
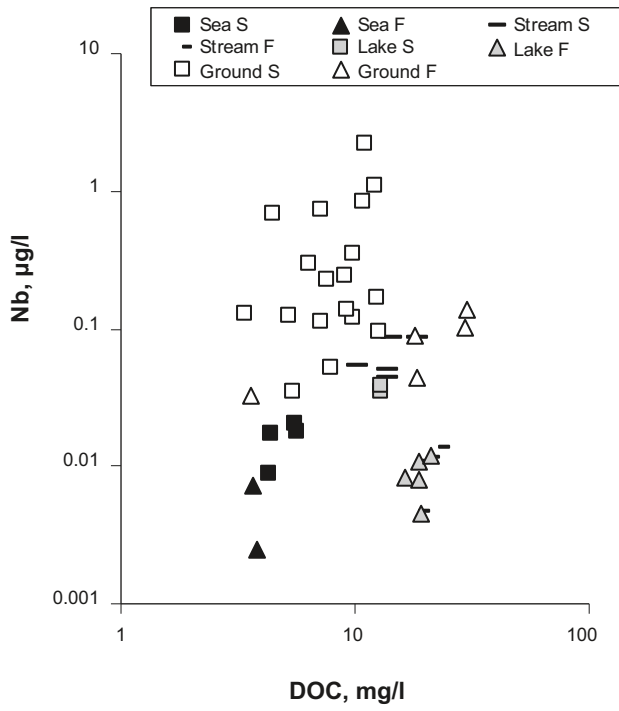

Figure 6-3. Relationship between concentrations of niobium (Nb) and dissolved organic carbon (DOC) and iron (Fe) in waters in Simpevarp (S) and Forsmark (F).

7 International co-operation

7.1 General

Eight organisations from seven countries have in addition to SKB participated in the co-operation at Äspö HRL during 2008, see Table 7-1. Six of them together with SKB form the Äspö International Joint Committee (IJC), which is responsible for the co-ordination of the experimental work arising from the international participation. The committee meets once every year. In conjunction with each IJC meeting a Technical Evaluation Forum (TEF) is held. TEF consists of scientific experts appointed by each participating organisation. For each experiment the Äspö HRL management establishes a peer review panel consisting of three to four Swedish or international experts in fields relevant to the experiment.

Most of the organisations participating in the Äspö HRL co-operation are interested in groundwater flow, radionuclide transport, rock characterisation and THMC modelling. Several of the organisations are participating in the two Äspö Task Forces on (a) Modelling of Groundwater Flow and Transport of Solutes, which is a forum for co-operation in the area of conceptual and numerical modelling of groundwater flow and solute transport in fractured rock and (b) THMC modelling of Engineered Barrier Systems, which is a forum for code development on THMC processes taking place in a bentonite buffer and gas migration through a buffer. These specific technical groups, so called Task Forces, are another form of organising the international work. The international co-operation is based on separate agreements between SKB and the organisations in question. The participation by JAEA and CRIEPI is regulated by one agreement. The participation of each organisation is given in Table 7-2.

SKB also takes part in several international EC-projects and participates in work within the IAEA framework. Äspö HRL is part of the IAEA Network Centres of Excellence for training and demonstration of waste disposal technologies in underground research facilities.

Table 7-1. List of participating organisations and members of IJC.

Agence nationale pour la gestion des déchets radioactifs, Andra, France (IJC)
Bundesministerium für Wirtschaft und Technologie, BMWi, Germany (IJC)
Central Research Institute of the Electronic Power Industry, CRIEPI, Japan (IJC)
Japan Atomic Energy Agency, JAEA, Japan (IJC)
Nuclear Waste Management Organisation, NWMO, Canada (IJC)
Posiva Oy, Finland (IJC)
Nationale Genossenschaft für die Lagerung Radioaktiver Abfälle, Nagra, Switzerland
Radioactive Waste Repository Authority, RAWRA, Czech Republic

Table 7-2. International participation in the Äspö HRL projects during 2008.

Projects	Andra	BMW	RIEPI	JAEA	NWMO	Posiva	Nagra	RAWRA
Natural barriers								
Tracer Retention Understanding Experiments				X				
Long Term Sorption Diffusion Experiment					X			
Colloid Transport Project						X		
Microbe Project		X						
Task Force on Modelling of Groundwater Flow and Transport of Solutes			X	X	X	X		
Engineered barriers								
Prototype Repository	X	X		X		X		
Long Term Test of Buffer Materials					X	X		
Alternative Buffer Materials	X	X		X		X	X	X
Temperature Buffer Test	X	X						
KBS-3 Method with Horizontal Emplacement						X		
Large Scale Gas Injection Test	X	X			X	X		
Task Force on Engineered Barrier Systems	X	X	X		X	X	X	X

7.2 Andra

The Agence nationale pour la gestion des déchets radioactifs, Andra, takes part in various Äspö projects all devoted to the understanding of the THMC behaviour of the engineered barrier systems. In 2008 Andra renewed a four year co-operation with SKB.

Andra is especially involved in the Temperature Buffer Test (TBT) which is running since 2003 and has already produced major expected THM results. In the logic of the project Large Scale Injection Test (Lasgit), it had been once considered to subject the fully saturated bentonite buffer in TBT to gas injection. However pre tests carried out in 2008 showed that required boundary conditions were not all present. Thus the gas test was cancelled and final dismantling of TBT is to be implemented in the following years.

The work carried out in 2008 with the support of the French agency in other projects like Alternative Buffer Materials, Large Scale Gas Injection Test and the Engineered Barrier Systems modelling Task Force has been fully integrated in the projects and is described in the respective project sections.

7.3 BMWi

In 1995 SKB and then BMBF (Bundesministerium für Bildung, Wissenschaft, Forschung und Technologie) signed the co-operation agreement being the frame for participating in the activities in the Äspö HRL. After the first prolongation in 2003 the agreement was extended a further five years in 2008. On behalf of and/or funded by the BMWi (Bundesministerium für Wirtschaft und Technologie) five research institutions are currently participating in experiments and activities connected with the Äspö HRL programme: Bauhaus Universität Weimar, Federal Institute for Geosciences and Natural Resources (BGR) in Hanover, DBE TECHNOLOGY GmbH in Peine, Forschungszentrum Dresden-Rossendorf (FZD), and Gesellschaft für Anlagen- und Reaktorsicherheit (GRS) mbH in Braunschweig.

The general purpose of the co-operation is to complete the state of knowledge concerning potential host rocks for high-level waste repositories in Germany and to extend the knowledge on the behaviour of the engineered barrier systems. Topics of special interest are:

- Studying the buffer material behaviour and the related basic processes by experiments and modelling.
- Investigations of the migration behaviour of radionuclides, especially actinides, under near field and far field conditions.
- Geochemical modelling of individual processes controlling migration.
- Investigation of the microbial activity with regard to the interaction with radionuclides.
- Thermodynamic databases for radionuclides relevant for long term safety.
- The work carried out in 2008 is described below.

7.3.1 Microbe Project

The activities of the Forschungszentrum Dresden-Rossendorf (FZD)/Institute of Radiochemistry (IRC) within the microbe project are concentrated in a project addressing the indirect interaction mechanism of a mobilisation of actinides by released bioligands from Äspö bacteria. The project results improve the understanding of the behaviour of colloids and microbes and their respective interaction with radionuclides. This project was finished at the end of 2008.

The project focuses on: (i) isolation and characterisation of microbial ligands produced from a subsurface strain of *Pseudomonas fluorescens* isolated at Äspö, (ii) interaction of U(VI), Np(V), and Cm(III) with the microbial ligands including compounds simulating the functionality of the microbial ligands and the surface of the bacteria and (iii) spectroscopic characterisation of the formed actinide complexes/compounds. The determined formation constants will be used directly in speciation and transport models.

The activities in 2008 were concentrated on (a) complexation studies of Np(V) with relevant pyoverdins model compounds and the pyoverdins, (b) complexation studies of U(VI), Cm(III) and Np(V)

with model molecules simulating the functionality of bacterial cell envelopes, and (c) complexation studies of Cm(III) with the secreted bioligand mixture of *P. fluorescens* found at Äspö HRL. All these should help to explain the interactions of actinides in biological systems on a molecular level. Selected results of the topic (c) will be reported here.

(c) – Curium(III) complexation with pyoverdins secreted by a groundwater strain of *Pseudomonas fluorescens*

Pyoverdins, bacterial siderophores produced by ubiquitous fluorescent *Pseudomonas* species, have great potential to bind /Moll et al. 2008a/ and thus transport actinides in the environment. Therefore, the influence of pyoverdins secreted by microbes on the migration processes of actinides must be taken into account in strategies for the risk assessment of potential nuclear waste disposal sites. The unknown interaction between curium(III) and the pyoverdins released by *Pseudomonas fluorescens* (CCUG 32456) isolated from the granitic rock aquifers at the Äspö HRL has been studied.

The interaction was studied at trace curium(III) concentrations ($3 \cdot 10^{-7}$ M) using time-resolved laser-induced fluorescence spectroscopy (TRLFS). Three Cm^{3+} -*P. fluorescens* pyoverdin species, $\text{M}_p\text{H}_q\text{L}_r$, could be identified from the fluorescence spectra, CmH_2L^+ , CmHL , and CmL^- , having peak maxima at 601, 607, and 611 nm, respectively. The large formation constants, $\log \beta_{121} = 32.50 \pm 0.06$, $\log \beta_{111} = 27.40 \pm 0.11$, and $\log \beta_{101} = 19.30 \pm 0.17$, compared to those of other chelating agents illustrate the unique complexation properties of pyoverdin-type siderophores. An indirect excitation mechanism for the curium(III) fluorescence was observed in the presence of the pyoverdin molecules.

Pseudomonas fluorescens (CCUG 32456 A) pyoverdins (LH_4) were isolated and characterised according to /Moll et al. 2008a/. A stock solution of the long-lived curium isotope ^{248}Cm ($t_{1/2} = 3.4 \cdot 10^5$ years) was used. This solution had the following composition: 97.3% ^{248}Cm , 2.6% ^{246}Cm , 0.04% ^{245}Cm , 0.02% ^{247}Cm and 0.009% ^{244}Cm in 1.0 M HClO_4 . The experiments were performed in a glove box under N_2 atmosphere at 25°C. As a background electrolyte, analytical grade 0.1 M NaClO_4 was used. To prevent the carbonate complexation of curium(III), carbonate-free water was used. The curium(III) concentration was fixed at $3 \cdot 10^{-7}$ M in all TRLFS measurements. Three series of experiments were performed to explore the complexation behaviour of curium(III) with the isolated pyoverdin fraction. In the first run, we investigated the curium(III) complex formation by varying the pyoverdin concentration between $3 \cdot 10^{-7}$ and $1 \cdot 10^{-5}$ M at a fixed pH of 4.17. In the second and third runs, the pyoverdin concentrations were kept constant at $3 \cdot 10^{-6}$ and $1 \cdot 10^{-5}$ M, respectively, while varying the pH between 2.0 and 11.0. The spectra were evaluated using the factor analysis program Specfit. Experimental details of the TRLFS setup are given in /Moll et al. 2008b/.

An overview of the emission spectra of curium(III) measured in the *P. fluorescens* (CCUG 32456) pyoverdin system is presented in Figure 7-1. The complexation of curium(III) with these bioligands had started even at pH 4.2 and low pyoverdin concentrations of $3 \cdot 10^{-7}$ M. This is depicted in Figure 7-1A by the decreased emission band of the Cm^{3+} aqua ion at 593.8 nm and the formation of a shoulder at 602 nm. A pyoverdin concentration of $3 \cdot 10^{-7}$ M lies in the range of hydroxamate siderophores identified in a variety of different soils /Powell et al. 1980/. Figure 7-1B presents the changes observed in the emission spectra at fixed concentrations of curium(III) and pyoverdin of $3 \cdot 10^{-7}$ M and $1 \cdot 10^{-5}$ M, respectively, as a function of pH. Three complex species can be differentiated on the basis of their individual emission bands at 601, 606, and 611 nm.

The spectral changes detected were used in the Specfit factor analysis program to describe the complex formation reactions occurring in the Cm^{3+} - *P. fluorescens* pyoverdin (LH_4) system, see Figure 7-1. The following equilibria could be identified /Moll et al. 2008b/:

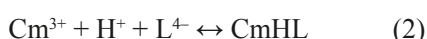
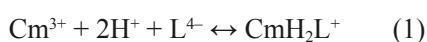

Formation constants for reactions (1)–(3) were calculated to be $\log \beta_{121} = 32.50 \pm 0.06$, $\log \beta_{111} = 27.40 \pm 0.11$, and $\log \beta_{101} = 19.30 \pm 0.17$, respectively, see Table 7-3. The corresponding single-component spectra of the individual species are summarised in Table 7-4. These results indicate that *P. fluorescens* (CCUG 32456) pyoverdins form strong 1:1 complexes with curium(III). No published data exist for curium(III), to provide a basis for comparison. Since pyoverdins are chelating agents synthesised by fluorescent *Pseudomonas* spp. to provide the cells with the essential iron(III), it is

not surprising that the corresponding formation constants are the largest. Furthermore, Table 7-3 indicates that pyoverdins are also able to complex elements other than Fe(III) at a considerably high efficiency. The complexation of curium(III) with *P. fluorescens* (CCUG 32456) pyoverdins is stronger than the complexation with EDTA ($\log \beta_{101} = 18.41$) /Choppin et al. 2006/, hydroxide ($\log \beta_{101} = 6.8 \pm 0.5$) /Edelstein et al. 2006/ or carbonate ($\log \beta_{101} = 8.1 \pm 0.3$) /Edelstein et al. 2006/.

The spectroscopic properties of the curium(III) complexes characterised in this study are summarised in Table 7-4. The emission peak maximum is shifted from 593.8 nm for the Cm^{3+} aqua ion to 601, 606, and 611 nm when curium(III) occurs in the three identified 1:1 pyoverdin complexes. Simultaneously, the emission intensity is increased by factors of 3.36, 19.63, and 8.10 for the three pyoverdin complexes, respectively. In agreement with previous findings regarding the absorption spectrum of the Cm^{3+} aqua ion, we found that the emission intensity of this species decreased by a factor of 65 when the excitation wavelength was changed from 395 to 360 nm. Under the same conditions, the intensities of the complexes: CmH_2L^+ , CmHL , and CmL^- , decreased by factors of only 1.12 ± 0.04 . At an excitation wavelength of 360 nm, the intensities of these complexes relative to that of the Cm^{3+} aqua ion are 197, 1,113 and 575, respectively. This indicates that fluorescence emission of the Cm^{3+} pyoverdin species can be generated either by direct excitation of the metal ion or by indirect excitation of the ligand followed by energy transfer from the ligand molecule to the metal ion.

In all samples in which the Cm^{3+} aqua ion and the first pyoverdin complex, CmH_2L^+ , are present, a mono-exponential decay was measured with an average lifetime of 83 μs ; this lifetime could correspond to the CmH_2L^+ species. In all samples with pH values above 3.4 and $[\text{LH}_4]$ of $3 \cdot 10^{-6}$ and $1 \cdot 10^{-5}$ M, bi-exponential decay was always detected with average lifetimes of 83 and 210 μs . The latter might correspond to the second pyoverdin species, CmHL . At pH values above 10, the second lifetime increased to 340 μs , indicating the formation of a third complex, CmL^- . This suggests a low ligand exchange rate for the pyoverdin complexes, compared to the fluorescence decay rate of the excited Cm^{3+} aqua ion. The increasing lifetimes of the curium(III) species reflect the exclusion of water molecules from the first coordination sphere of curium(III), due to the identified complex formation reactions. The fluorescence lifetimes as measured by direct and indirect excitation match closely.

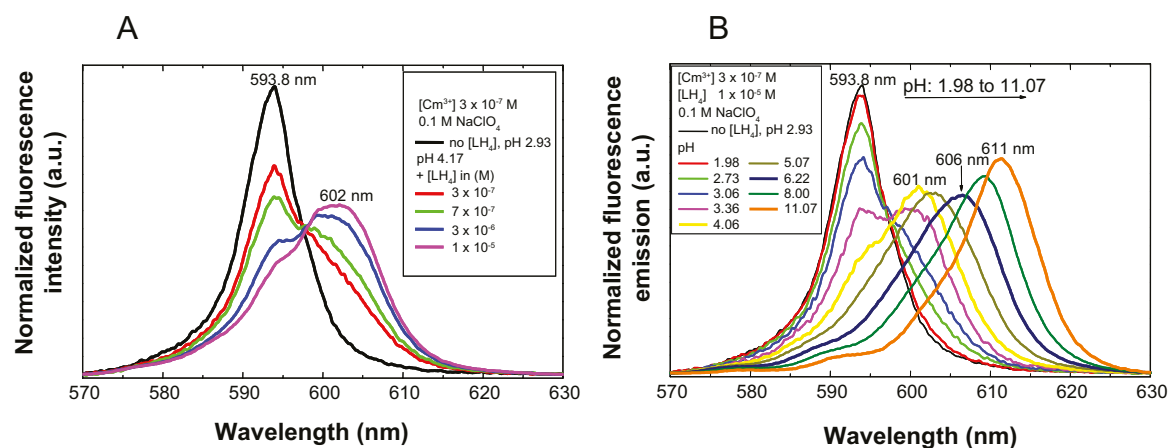

Figure 7-1. Fluorescence spectra of $3 \cdot 10^{-7}$ M curium(III) in 0.1 M NaClO_4 measured: (A) as a function of the pyoverdin concentration, LH_4 , at pH 4.17 and (B) at a fixed pyoverdin concentration of $[\text{LH}_4] 1 \cdot 10^{-5}$ M as a function of pH. The spectra are scaled to the same peak area.

Table 7-3. Comparison of the Cm³⁺ – P. fluorescens (CCUG 32456) pyoverdin stability constants with those of the corresponding Fe³⁺ species at an ionic strength of 0.1 M (NaClO₄).

Species / M _p H _q L _r	Bacteria / chelating agent	Methods	log β	Reference
Cm(III)H ₂ L ⁺ / 121	<i>P. fluorescens</i> (CCUG 32456) / Pyoverdin mixture	Fluorescence	32.50 ± 0.06	This study
Cm(III)HL / 111		spectroscopy	27.40 ± 0.11	
Cm(III)L ⁻ / 101			19.30 ± 0.17	
Fe(III)H ₂ L ⁺ / 121	<i>P. aeruginosa</i> (ATCC 15692) / Pyoverdin PaA	Spectroscopy & Cyclic voltammetry	47.80 ± 0.20	/Albrecht-Gary et al. 1994/
Fe(III)HL / 111			43.00 ± 0.30	
Fe(III)L ⁻ / 101			30.80 ± 0.30	

Table 7-4. Spectroscopic properties of the identified curium(III) species.

	Cm ³⁺ (aq)	CmH ₂ L ⁺ ^a	CmHL ^b	CmL ⁻ ^c
Excitation (nm)	374.4 (3.6) ^d 379.9 (2.9) 396.0 (2.2)	372.6 (5.4)	373 ^e	366 (25)
		377.8 (4.6)	385 ^f	377 ^e
		386.0 (7.6)	389 ^f	386 (4.8)
		395.4 (8.4)	395 ^f	394 ^f
			400 ^f	
Emission (nm)	593.8 (8.2) ^d	593.7 ^e	602.5 ^e	605.3 ^e
		602.2 (11.6)	608.4 (7.9)	610.8 (6.9)
				614.6 ^e
Lifetime (μs)	68 ± 1	86 ± 2 (80%)	83 ± 2 (64%)	100 ± 5 (71%)
		198 ± 10 (20%)	229 ± 5 (36%)	330 ± 10 (29%)
I _{rel} (395)	1	3.36	19.63	8.10
I _{rel} (360)	1	197.2	1,112.7	575.3

^a In 1·10⁻⁵ M LH₄ at pH 4.17 (88% CmH₂L⁺ and 12% CmHL). ^b In 3·10⁻⁶ M LH₄ at pH 7.00 (98% CmHL and 2% CmH₂L⁺). ^c In 1·10⁻⁵ M LH₄ at pH 11.07 (98% CmL⁻ and 2% CmHL). ^d Values in parentheses are full width at half- maximum. ^e Shoulder. ^f Broad, poorly resolved bands.

In conclusion, the use of TRLFS in combination with the SPECFIT factor analysis software provides an applicable method for investigating the speciation of curium(III) in the aqueous *P. fluorescens* (CCUG 32456) pyoverdin system. Strong Cm³⁺ pyoverdin species are formed, indicating the great potential of these unique siderophores to mobilise curium(III) in the biologically relevant pH range. Three Cm³⁺ pyoverdin complexes, CmH₂L⁺, CmHL, and CmL⁻, could be identified by their individual emission spectra, see Figure 7-2. The results of the present work contributed to an improved understanding of the chemistry of curium(III) coordination with natural siderophores of the pyoverdin type in aqueous solution. Such complexation studies of selected bioligands are essential to explain the overall interaction processes of actinides with microbes at a molecular level. The determined stability constants can be used to quantify the effect on actinide-mobilising by the bioligands released.

7.3.2 Prototype Repository

In the Prototype Repository Project electric resistivity measurements are conducted in boreholes and backfilled tunnel sections in order to investigate time-dependent changes of water content in the buffer, the backfill, and in the rock. In these investigations advantage is taken of the dependence of the electrical resistivity of geomaterials on their water content. In order to enable correlation of the measured resistivity with the actual water content, laboratory calibration measurements were performed in the geotechnical laboratory of GRS in Braunschweig, Germany.

The measuring programme, agreed on by SKB and GRS, includes the monitoring of two electrode arrays in the backfilled drift above the deposition boreholes 3 and 6, an electrode array in the buffer at the top of deposition hole 5, and three electrode chains in the rock between deposition holes 5 and 6, see Figure 7-3. Special water-tight cables and connectors had been selected for connections between the electrodes and the geoelectric monitoring system which was installed in the data acquisition room in the parallel G-tunnel.

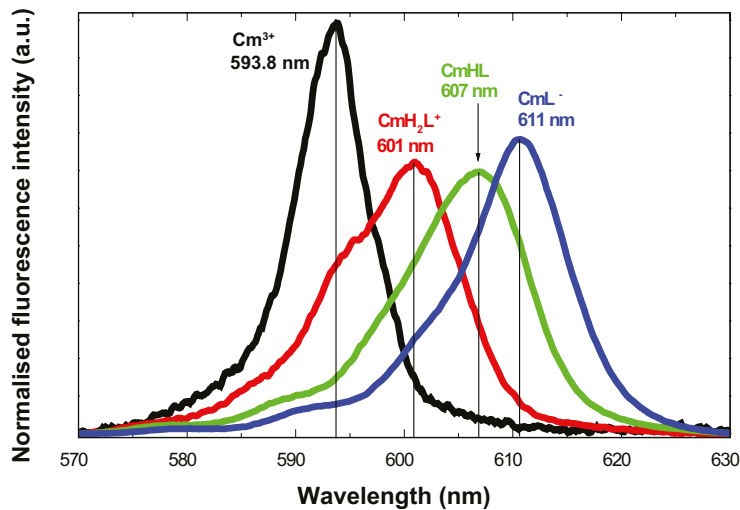

Figure 7-2. Fluorescence spectra of the single components in the Cm^{3+} – *P. fluorescens* (CCUG 32456) pyoverdinin system, as derived by peak deconvolution using Specfit. The spectra are scaled to the same peak area.

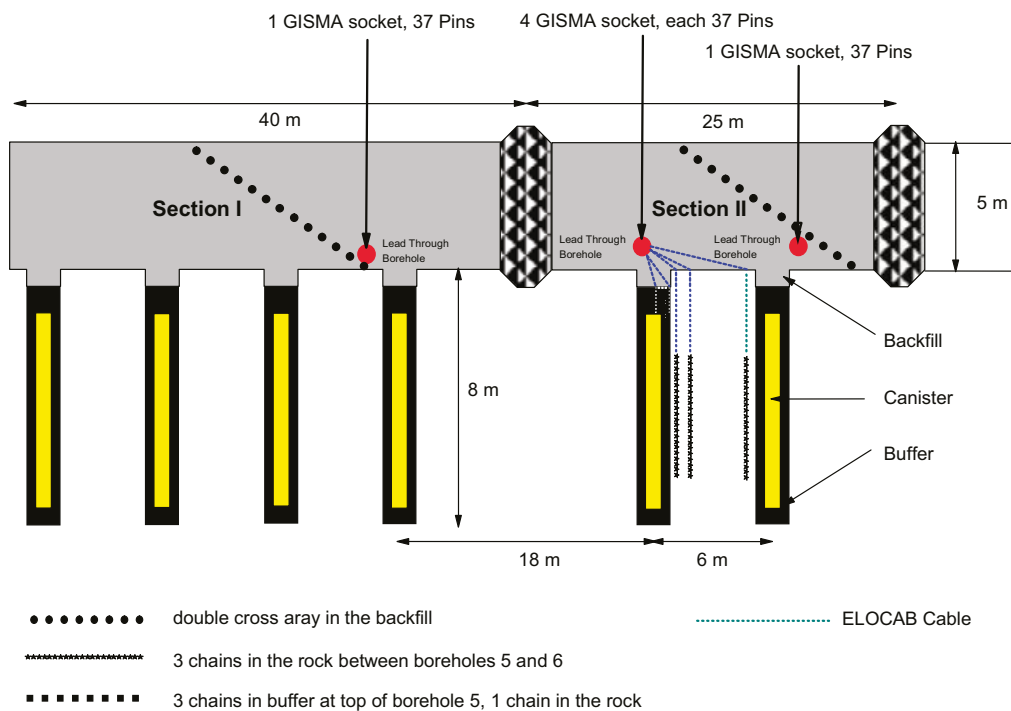

Figure 7-3. Arrangement of electrode arrays in the Prototype Repository. The deposition holes (1 to 6) are numbered from left to right.

The first measurements were started in Section I in October 2001 and from June 2003 all arrays were active. In 2008, the measurements have continued as planned. In section I of the backfill the resistivity decreased until the end of 2007 when it was below $2 \Omega\text{m}$ in the whole measuring cross section. This corresponds to a water content above 25%. From the geoelectric point of view the backfill in section I could be regarded as fully saturated. In 2008, however, a slight increase in resistivity was detected, see Figure 7-4. The reason for this is unclear at the time being; the resistivity evolution has to be monitored further.

In Section II, the resistivity is now unchanged after having decreased to values around $3 \Omega\text{m}$ in the centre (corresponding to a water content of 21–22%) and $2\text{--}3 \Omega\text{m}$ near the tunnel walls. Section II is close to saturation as well.

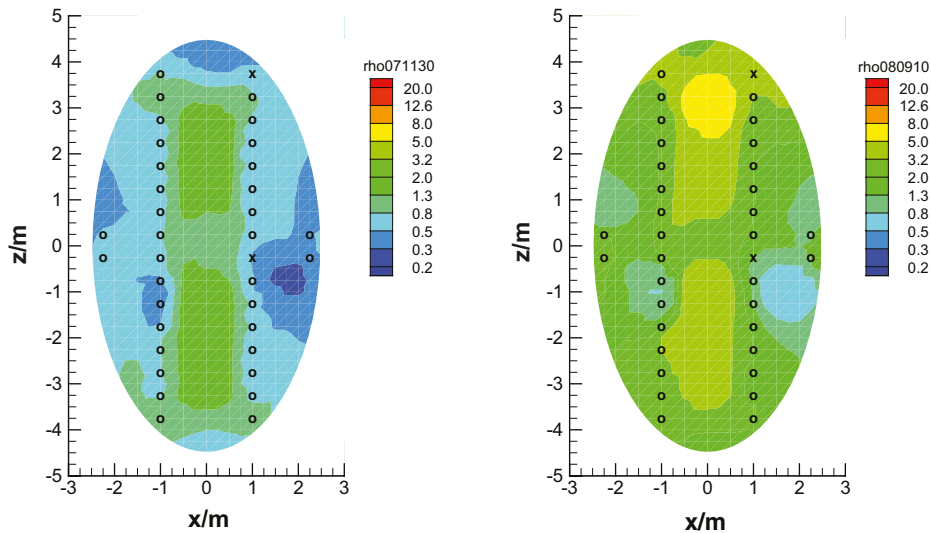

Figure 7-4. Resistivity distributions in the backfill in Section I, November 2007 (left) and September 2008 (right). Colour scale for resistivity in Ωm .

The measurements in the buffer can no longer be evaluated in terms of water content because of the failure of several electrodes at the end of 2005. The reason for the failure is still unclear; an excavation of the electrodes in the course of post-test investigations will yield the necessary information.

The resistivity distributions along the three electrode chains installed in the rock are quite similar to each other. Close to the electrodes, the resistivity ranges around 200 Ωm . This value characterises the water-saturated concrete used for backfilling the electrode boreholes. Further away from the boreholes, the resistivity rises to values of 2,000 to 7,000 Ωm which is characteristic for saturated granite. During the last 2½ years, slight resistivity changes around the electrode chain close to deposition hole 5 were detected, see Figure 7-5. First increasing resistivities that now are decreasing again, which might be attributed to water content changes of the concrete backfill of the electrode hole and possibly of the surrounding rock. At the other chains in the rock, no such behaviour was detected.

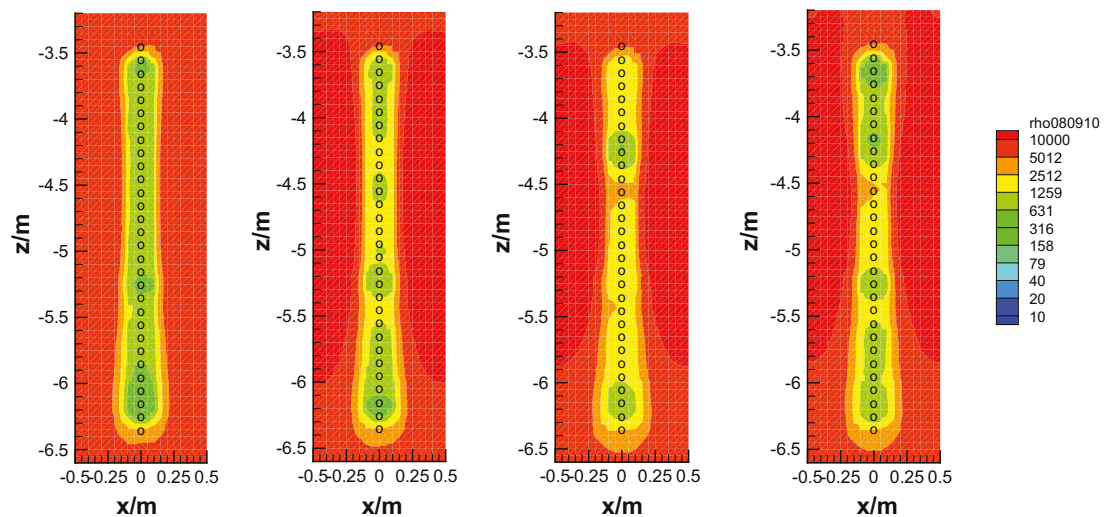

Figure 7-5. Resistivity evolution along the electrode chain in the rock close to deposition hole 5. From left to right: 31.05.06 – 30.11.06 – 30.11.07 – 10.09.08. Colour scale for resistivity in Ωm .

7.3.3 Alternative Buffer Materials

Prior to the Alternative Buffer Materials test, samples of each of the eleven different precursor materials have been distributed to all partners by SKB. These samples had to be characterised with particular care because they represent the reference values which are used for the identification of changes of any material properties. In 2008 BGR focused on the detailed characterisation of the 11 different ABM samples. Hence a significant set of analyses (XRD, XRF, DTA, IR, CEC, BET, LECO) were applied, now providing a conclusive and reliable idea of precursor material compositions.

7.3.4 Temperature Buffer Test

As the temperature is one of the main forces of hydro-mechanical (HM) changes within the bentonite/sand barrier, the simulation of the temperature development is of major importance. The code Tough2 /Pruess et al. 1999/ was applied to calculate the thermo-hydraulic (TH) coupled two-phase flow in bentonite whereas a good fit of computed and measured temperature and suction values have been achieved and for hydraulic and thermal calculations plausible parameter sets have been obtained so far. The TH coupled calculations were performed by means of simplified axisymmetric 2D (quasi 3D) model, see Figure 7-6. Suction controlled saturation process is simulated by using van Genuchten's formula (Table 7-5 and Table 7-6) and thermal conductivity is determined as a function of temperature and water content (Table 7-7).

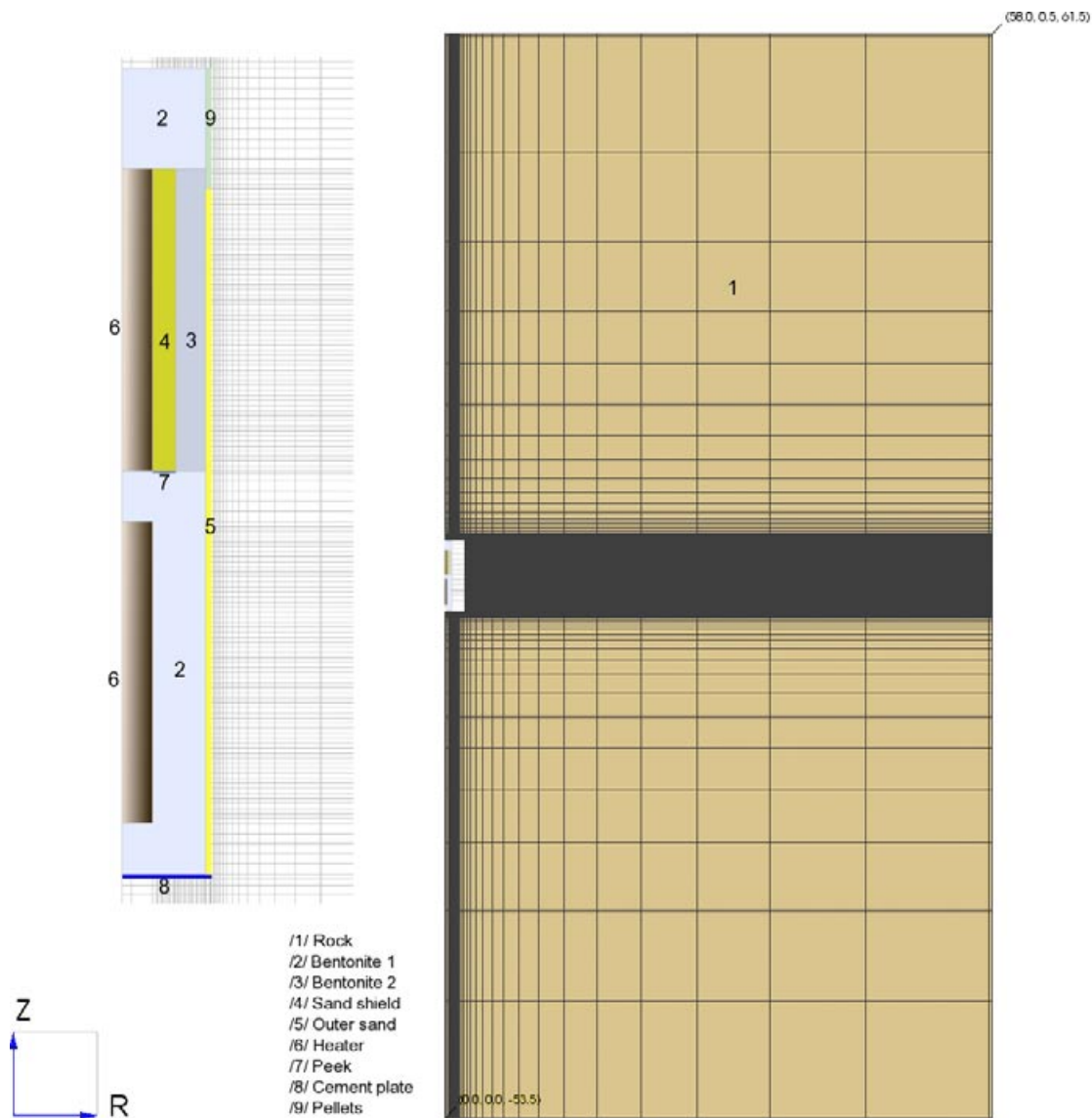

Figure 7-6. Model geometry and materials considered (2D axisymmetric).

Table 7-5. Thermal conductivity and specific heat capacity values /Pruess et al. 1999/.

Material	Law	λ_{dry} [W m ⁻¹ K ⁻¹]	$\lambda_{saturated}$ [W m ⁻¹ K ⁻¹]	C_p [J kg ⁻¹ K ⁻¹]
Bentonite 1		0.57	1.36	1,091
Bentonite 2	$\lambda = \lambda_{dry} + \sqrt{S_L \cdot (\lambda_{sat} - \lambda_{dry})}$	0.57	1.36	1,091
Solid rock		1.73	3.0	800
Pellets		0.6	0.81	1,091
Sand buffer		0.4	1.38	900
Sand filter	Note: In the code <i>thermal anisotropy factor</i> is not implemented.	0.6	1.7	900
Concrete		1.7	1.7	900
Heater		50.16	50.16	480

Table 7-6. Capillary pressure function and parameters /Van Genuchten 1980, Rodwell et al. 1999, Jobmann 2000, Schaap and Van Genuchten 2005, Zhang et al. 2007/.

Material	Law	m [-]	S_{lr} [-]	P_0 [MPa]	P_{max} [MPa]	S_{ls} [-]
Bentonite 1	$P_{cap} = -P_0 \left((S^*)^{-1/m} - 1 \right)^{1-m}$	0.33	0.001	42.92	90	1.0
Bentonite 2	$S^* = \frac{(S_l - S_{lr})}{(S_{ls} - S_{lr})}$	0.33	0.001	42.92	90	1.0
Solid rock		-	-	-	-	-
Pellets		0.4	0.001	0.02	80	1.0
Sand buffer	$-P_{max} \leq P_{cap} \leq 0$	0.3	0.001	0.1	80	1.0
Sand filter	$0 < m < 1$	0.3	0.001	0.1	80	1.0
Concrete		0.3	0.001	0.3	90	1.0
Heater	$S_{lr} < S_l < S_{ls} < 1$	-	-	-	-	-

Table 7-7. Relative permeability equations /Corey 1954, Fatt and Klikoff 1959, Mualem 1976, Grant 1977, Van Genuchten 1980/.

Material	Law	m [-]	S_{lr} [-]	S_{ls} [-]	S_{gr} [-]
Bentonite 1		0.8	0.05	1.0	0.1
Bentonite 2	$k_{rl} = \begin{cases} \sqrt{S^*} \left\{ 1 - \left(1 - (S^*)^{1/m} \right)^m \right\}^2 & \text{if } S_l < S_{ls} \\ 1 & \text{if } S_l \geq S_{ls} \end{cases}$	0.8	0.05	1.0	0.1
Solid rock		0.3	0.1	1.0	0.1
Pellets		0.8	0.1	1.0	0.1
Sand buffer	$k_{rg} = \begin{cases} 1 - k_{rl} & \text{if } S_{gr} = 0 \\ (1 - \hat{S})^2 \cdot (1 - \hat{S}^2) & \text{if } S_{gr} \geq 0 \end{cases}$	0.8	0.05	1.0	0.1
Sand filter		0.8	0.05	1.0	0.1
Concrete		0.8	0.05	1.0	0.1
Heater	$k_{rl} = (S^*)^3, \quad k_{rg} = (1 - S^*)^3$	-	0.3	-	-

$0 \leq k_{rl}, k_{rg} \leq 1; \quad S^* = (S_l - S_{lr}) / (S_{ls} - S_{lr}), \quad \hat{S} = (S_l - S_{lr}) / (1 - S_{lr} - S_{gr})$

Good fits between measured and computed temperature values around both heaters have been obtained. Subsequent to thermal calculations, the thermal-only calibrated model was selected as an initial model for hydraulic analyses and approximately two hundred and thirty simulations were performed. In the framework of sensitivity analyses, the hydraulic parameters related to capillary pressure were used in order to calibrate the results of simulations with the in situ data.

Finally, for suction the most sensitive parameters were obtained, these are; saturation of the liquid phase S_L , Van Genuchten's notation m and intrinsic permeability along the x direction k_x in turn. For different distances to the heaters, suitable fittings of the computed and the measured capillary pressure values were obtained by using residual calculations method.

In Table 7-8 the mean residual values for absolute capillary pressure indicate the accuracy of the fitting for each parameter change. To obtain a good fit of measured and computed curves of absolute capillary pressure evolving with time, the mean residual value must be as small as possible. In case the mean residual is zero, the measured and simulated curves are overlapping each other.

The two-dimensional (2D) temperature evolution for thermal calculations is shown in Figure 7-7. In vertical and horizontal directions the temperature field shows a quite homogenous distribution except in sand buffer as it is intended. Along the sand buffer, heat flow is slowed down due to the low thermal conductivity of the sand buffer (λ). Thus the temperature is significantly higher than in the other materials.

In Figure 7-8 the computed and measured temperature values show a very good fit along the scan-line H1 except in the range 0.3 – 0.4 m. Computed temperature values on the surface of the heater ($r=0.3$ m) are underestimated due to model geometry adjustments.

By means of the sensitivity analyses and the residual error calculation, best fit models for suction sensors were obtained. One of the best fit model for the sensors WB-215 and WB-220 is shown in Figure 7-9. For WB-215 computed and measured values show a good fit except a small overestimation which is due to the unpreventable high suction in the simulation. For both sensors WB-215 and WB-220, computed values as well as measured values show a small drying cycle between 70th and 90th days. This may be explained by a beginning pressure drop in injection level-2.

Table 7-8. Mean residual values for absolute capillary pressure, $O_{P_{cap}}$ (p), in the simulation sessions.

Parameters	Best calculation values	Mean residuals, $O_{P_{cap}}$ (p) [MPa]	Simulation sessions [No.]
S_L	0.8778	0.249	TBT-1
S_{is} (P_{cap})	1.00	1.531	TBT-2
P_{max}	9 MPa	0.375	TBT-3
S_{ir} (P_{cap})	0.0011	1.524	TBT-4
m (P_{cap})	0.363	1.498	TBT-5
S_{gr}	0.25	1.523	TBT-6
k_x	$7 \cdot 10^{-21} \text{ m}^2$	0.472	TBT-7
k_z	$2.88 \cdot 10^{-21} \text{ m}^2$	1.523	TBT-8
P_o	10 MPa	0.464	TBT-9
S_{ir} (Rel. Per.)	0.095	1.516	TBT-10
m (Rel. Per.)	0.72	1.476	TBT-11
S_{is} (Rel. Per.)	1.00	1.531	TBT-12
Φ	0.15	0.365	TBT-13

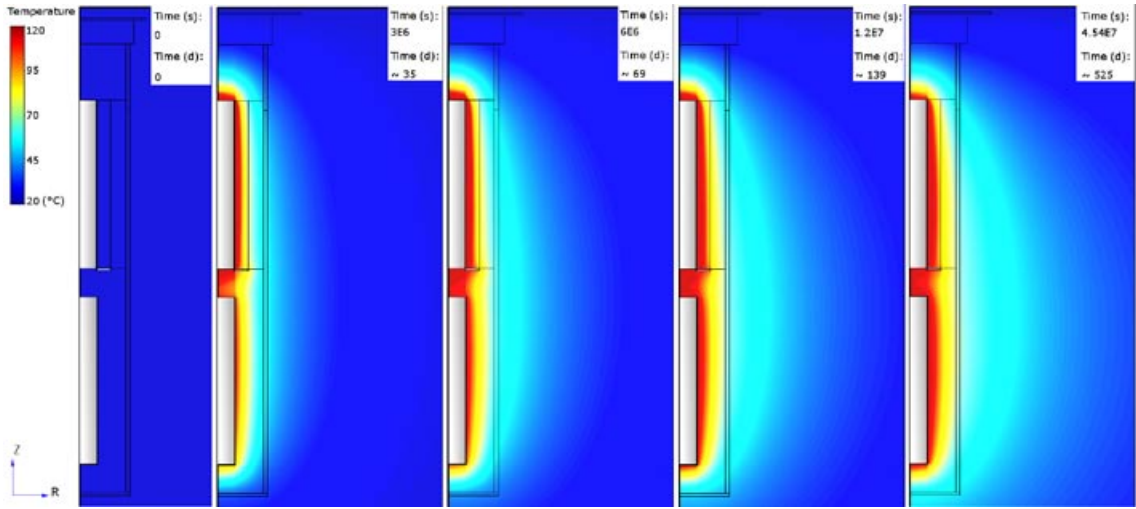

Figure 7-7. 2D isoline plots for temperature evolution in the model domain (thermal back analyses).

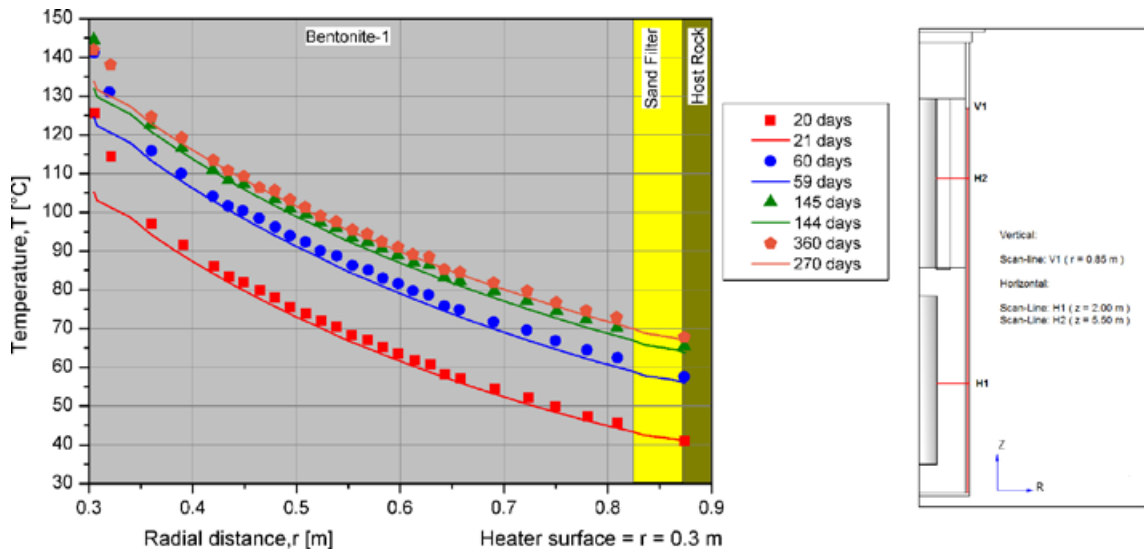

Figure 7-8. Temperature curves along the scan-line H1, comparison of measured (points) and computed (lines) values on different time steps.

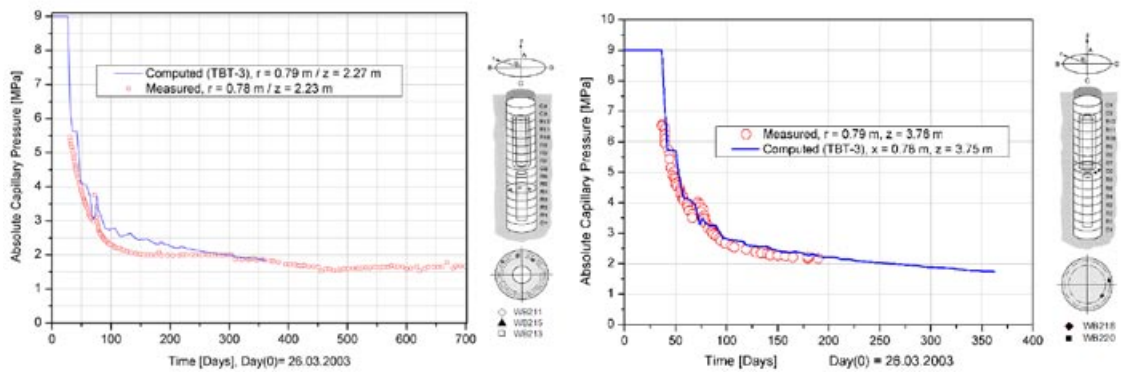

Figure 7-9. Absolute capillary pressure curves at the suction sensors WB-215 (left) and WB-220 (right), comparison of measured and computed values.

An example of the two-dimensional (2D) suction evolution for the hydraulic calculations (simulation TBT-3) is shown in Figure 7-10. It should be reconsidered that capillary pressure depends on the liquid phase saturation (see Table 7-6) hence suction isolines are consistent with liquid saturation evolution. In bentonite, suction decreases gradually with the water inflow through the injection level-1. In the same figure on time step $t=175$ days, ‘bentonite 2’ shows higher suction values than ‘bentonite 1’ due to the parameter adjustments done in the hydraulic part. On the day 336, suction isolines in the zone between sand buffer and ‘bentonite 2’ show a wide spread compare to ‘bentonite 1’. This can be explained with the large difference between the intrinsic permeabilities of sand buffer and ‘bentonite 2’ (approximately order of 10^{-6}).

For comparison and fitting of measured and computed temperatures, sensors around ring R4 (canister 1) and ring R10 (canister 2) located at different radii (0.343, 0.36, 0.542 and 0.78 m) have been used and a set of best fit parameters was found, some of them are listed in Table 7-5. Besides some deviations in the very transient phase, the temperature evolution within the Temperature Buffer Test can be described sufficiently well.

During the second part of the model calculations, the hydraulic back analyses are performed focusing on the capillary pressure determination. The computed capillary pressure and liquid saturation results were illustrated on 2D isoline plots and scan-line figures. By using residual calculations subsequent to sensitivity analyses (except the over-estimation of computed suction values for the sensor WB-235) plausible fits ranging between 0 to 2.5 MPa were obtained for the suction sensors WB205, WB215, WB218, WB220, WB228 and WB230.

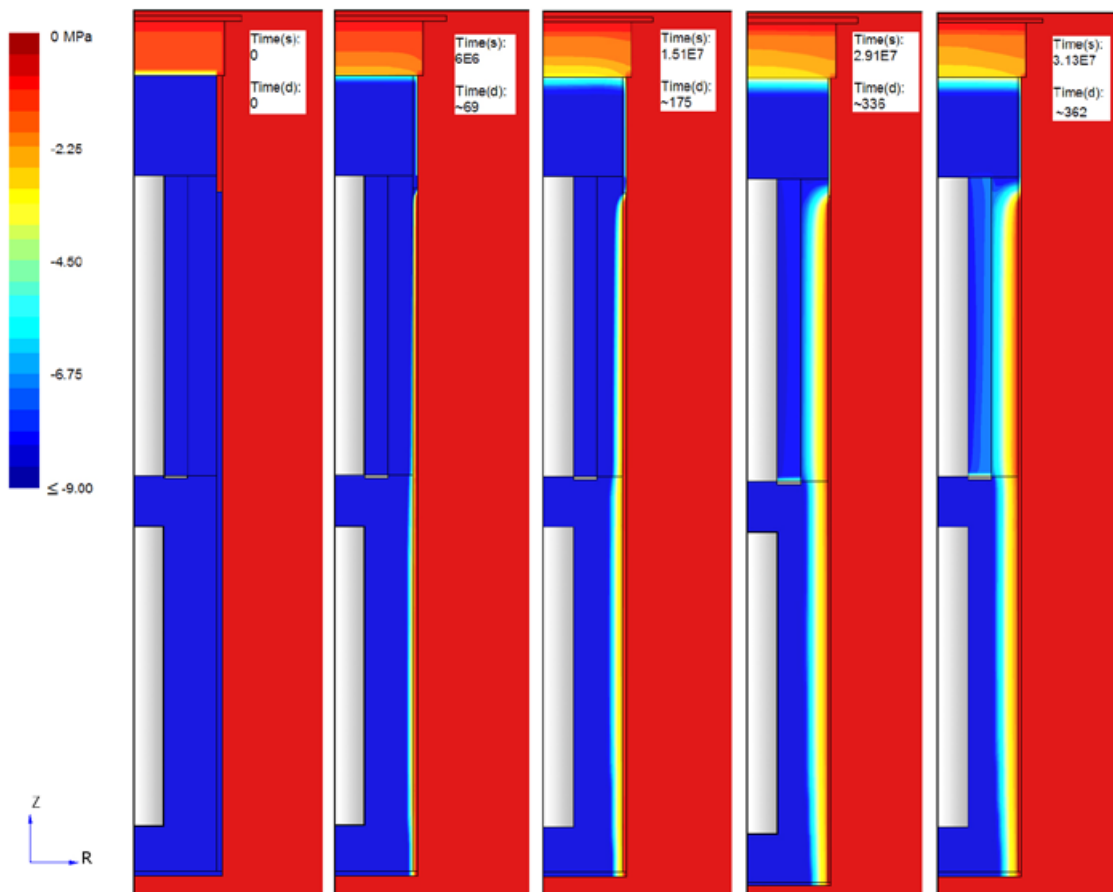

Figure 7-10. 2D isoline plots for suction evolution in the model domain (simulation TBT-3).

7.3.5 Task Force on Engineered Barrier Systems

BGR participates in task 1 (THM-coupled processes) and task 2 (gas migration processes) in the clay-rich buffer materials. Parallel computing with the code Geosys/RockFlow was established successfully using data from Benchmark 2 (large scale field tests) as an example. The final results for the 3D THM-coupled modelling of the Isothermal Test and the Buffer/Container Experiment will be submitted for reporting in 2009. The work on the Canister Retrieval Test started in 2008 and will be finished in 2009. Though this benchmark is only about the Canister Retrieval Test the nearby Temperature Buffer Test was included in the 3D model. The heat released from TBT had a strong influence on CRT. The calculated temperatures and water contents in the buffer show a good agreement with the measured values. Parallel computing allows simulating both experiments in one model without any difficulty.

GRS participates in the benchmark on CRT using code Viper. As a preparative activity, the code was modified by including some new features that had not been relevant for earlier exercises, namely, radial symmetry, varying initial water content, and dealing with tabulated isothermal data.

Including an option for radial symmetry implicated an extensive revision of the balance equations. The development of initial and boundary conditions was also a special challenge because of a water-filled gap at one side, a gap filled with bentonite pellets and water at the cool side. Analytical temperature fields at certain points in time were constructed using measured data lying in between. The temperature was linearly interpolated for a specific model time.

A rather good match between measurement and simulation could be achieved for all three sensors during the first 60 days, see Figure 7-11. Afterwards, the data related to the sensor located closest to the heater began to deviate and after 110 day the data from the middle sensor showed the same behaviour. A reason for this discrepancy may be the rather high initial water content. This in turn could show aspects of the conceptual model that have not been realised yet. Investigations to tackle these aspects are scheduled to take place next year.

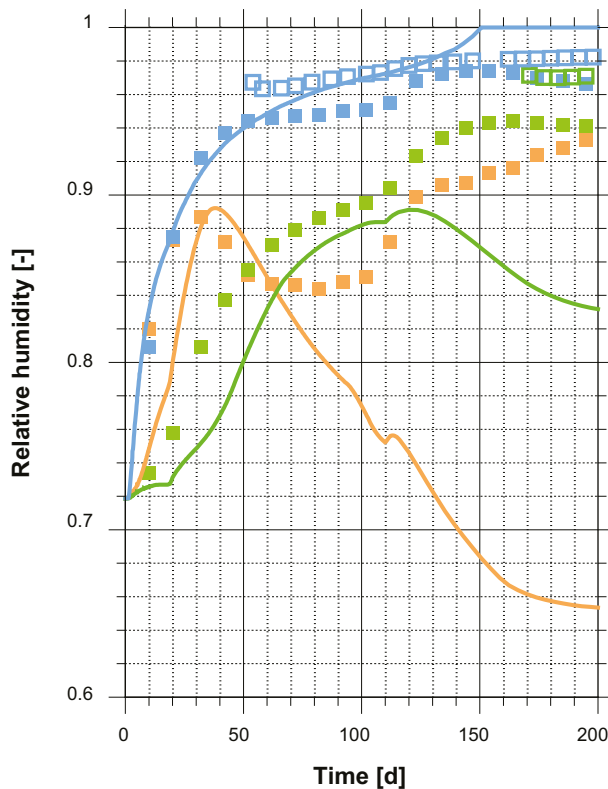

Figure 7-11. Measured (squares) and simulated (lines) breakthrough curves for relative humidity in the Canister Retrieval Test.

Because of the complex and coupled behaviour mathematical modelling is a difficult task and results in sophisticated constitutive models with a large number of associated parameters. This call for advanced, unique, time to develop methodology for model identification based on less experiments combined with numerical simulation and consequently back calculation of the model parameters. The aim of our study is to investigate the ability of a direct iterative model calibration to serve as a tool for complex coupled hydromechanical (HM) model parameters identification.

As a result a critical discussion is presented regarding the importance of boundary and initial conditions applicable to the experimental installation in calibration of the constitutive functions. In practice, it may not be always possible directly to measure or provide sufficient and reliable laboratory tests data for determining the material model parameters and to fit the constitutive functions. This is especially applicable to models coupling different physical processes and particularly for boundary value problems involving mechanical and hydraulic forces. That is why often in numerical simulations the constitutive functions and the involved parameters are subjected to assumptions and simplifications.

In the literature devoted to parameter calibration in unsaturated soil mechanics the common approach is to perform and use data from two types of experiments, namely constant suction and constant net stress tests. It is a rare practice to verify the procedure used in best fit analysis and to validate the model calibration. This deficiency reflects to the quality of the numerical simulations and respectively reduces the trust in the numerical predictions. The analysis in our project concerns the identification of coupled HM model parameters that are difficult to be determined directly and reliably from laboratory or field measurements.

An important point in completing successfully the model identification procedure is to choose the solution strategy that is most appropriate regarding the model features, and the available observation data that are suitable concerning the requested applications. The solution strategy consists of: (a) selection of the back analysis approach, (b) sensitivity analysis, (c) selection of the subset of parameters to be subject of an optimisation, (d) assessing the parameters' constraints or trusted zone and initial values, if requested and (e) selection of the most suitable optimisation problem algorithm.

It is of paramount importance to build the model and the identification procedure in the way they provide efficient, robust and resource provident analysis. Back analysis problems may be solved in two different ways, defined as inverse and direct approaches. The inverse back analysis consists in inverting the model equation with respect to the parameters that are unknown and subject to identification. The direct approach is based on an iterative procedure correcting the trial values of the unknown parameters by minimising error functions. This way the model response data are provided by trial forward solutions of the problem used for model parameters identification.

For our project the iterative direct approach has been chosen. The decision is based on the fact that such an approach gives the opportunity to be coupled with standard and well approved finite element/differences programs and does not require access to the source code. Additionally for complex and nonlinear problems the direct approach is not only more robust but may be the only possible solution.

7.4 CRIEPI

Central Research Institute of Electric Power Industry (CRIEPI) participate mainly in modelling activities. CRIEPI has participated in the Task Force on Modelling Groundwater Flow and Transport of Solutes and performed modelling work for Task 7, reduction of performance assessment uncertainty through modelling of interference tests at Olkiluoto, Finland. CRIEPI has also participated in the Task Force on Engineered Barrier Systems, tackled benchmark problems and compiled a report on the calculation results.

7.4.1 Task Force on Modelling Groundwater Flow and Transport of Solutes

During 2008, CRIEPI has finalised modelling work for sub-task 7A, reduction of performance assessment uncertainty through site scale modelling of long-term pumping test at Olkiluoto, Finland and compiled a draft of ITD report.

During the year, CRIEPI has also started modelling work for sub-task 7B, which concerns reduction of performance assessment uncertainty through block scale modelling of interference tests in KR14-18 at Olkiluoto, Finland and built a hydrostructural model for the target rock mass of the interference tests. The modelled area is a 500 m square centred on the borehole KR15. The upper boundary is the ground surface and the bottom boundary is at a depth of 600 m below sea level. The upper boundary and the lower boundary are assumed to be seepage-face type boundary and impermeable, respectively. The hydrostatic pressure from groundwater table under the natural condition is basically specified on the side boundaries. But the hydraulic head interpolated from a larger area may be used at the side boundaries, if necessary.

Inside the modelled volume, there are 9 site scale major fracture zones (HZ19A, HZ19C, HZ20A, HZ001, HZ099, HZ19B, HZ20B, HZ21 and HZ21B) see Figure 7-12. Three major fracture zones (HZ19A, HZ19C and HZ20A) are expected to dominate groundwater flow in the modelled volume. Therefore these fracture zones are modelled explicitly by using 2-D finite elements. On the other hand, the other fracture zones are expressed implicitly by smeared fracture model. Geometric mean transmissivity from measurements of each zone is given to the most part of the zone. However the measured transmissivity value at each intersection of fracture zones with boreholes is assigned to the area around the intersection. The transport aperture of each fracture zone is derived from Doe's law.

As for background rock, small scale fractures around KR14-18 are expressed by smeared fracture model with conditioning of realisations to borehole data and small scale fractures and matrix in the other area are expressed by equivalent continuum model. Small scale fractures are generated stochastically on the basis of the statistics of density, orientation and length scale, see Figure 7-13. The following equation is used as the relationship between transmissivity T and diameter L of small scale fractures:

$$T = aL^b$$

where a and b are the constants. There seems to be depth dependency of the hydraulic conductivity of the background rock, see Figure 7-14. Therefore the hydraulic conductivity K of equivalent continuum model is given by the following equation:

$$K = 1 \times 10^{-5} z^{-2}$$

where z is the depth. Groundwater flow simulations were conducted for the realisations of rock block in which small scale fractures were generated stochastically and the hydraulic conductivity tensor of equivalent continuum model has been derived as follows:

$$\begin{pmatrix} k_{xx} & k_{xy} & k_{xz} \\ k_{yx} & k_{yy} & k_{yz} \\ k_{zx} & k_{zy} & k_{zz} \end{pmatrix} = K \begin{pmatrix} 1.108 & 0 & 0 \\ 0 & 1.062 & 0 \\ 0 & 0 & 0.850 \end{pmatrix}$$

In this area, low-angle to intermediate-angle fractures are dominant, see Figure 7-15. As a consequence, the permeability in horizontal direction is larger than the one in vertical direction.

There are 13 observation boreholes in the area. These boreholes are expressed with one-dimensional finite elements. Figure 7-16 shows the numerical representation of our hydrostructural model and Figure 7-17 shows the finite element mesh used for numerical simulations. The areas of fracture zones and background rock adjacent to boreholes are divided into smaller elements.

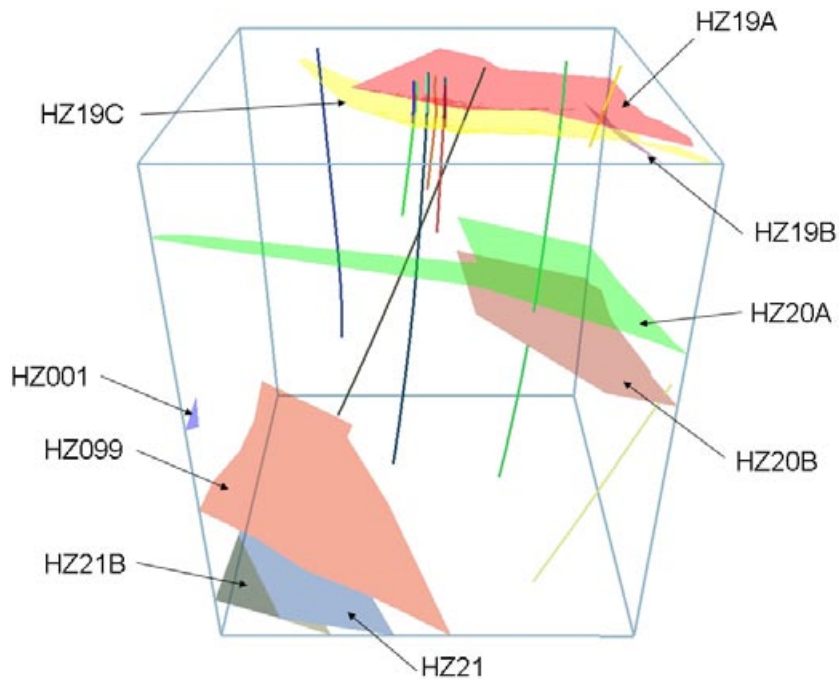

Figure 7-12. Location of major fracture zones in modelled domain.

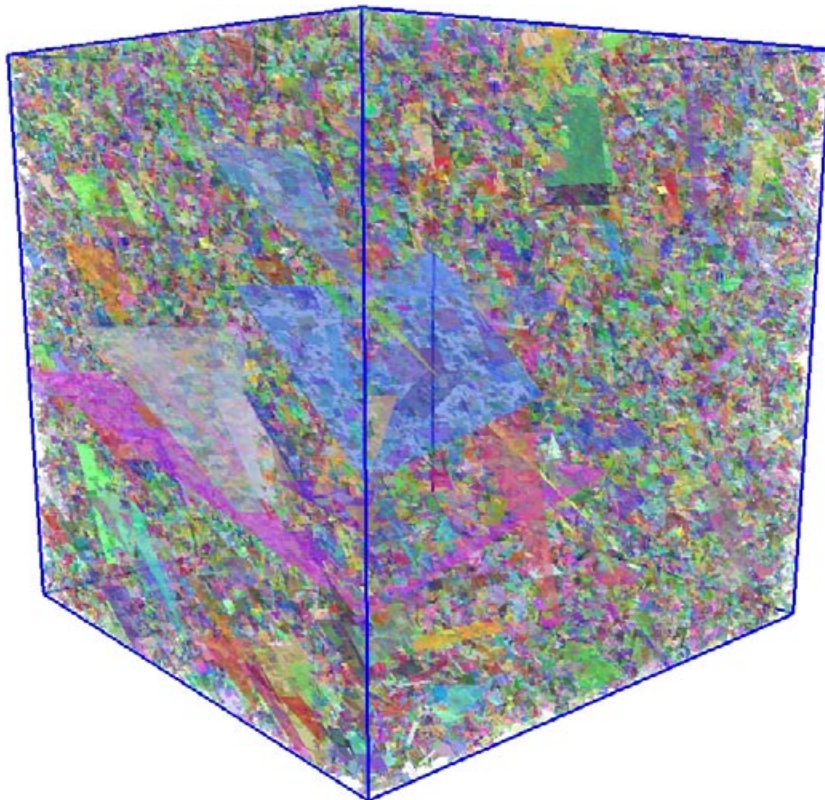

Figure 7-13. Example of distribution of stochastically generated fractures.

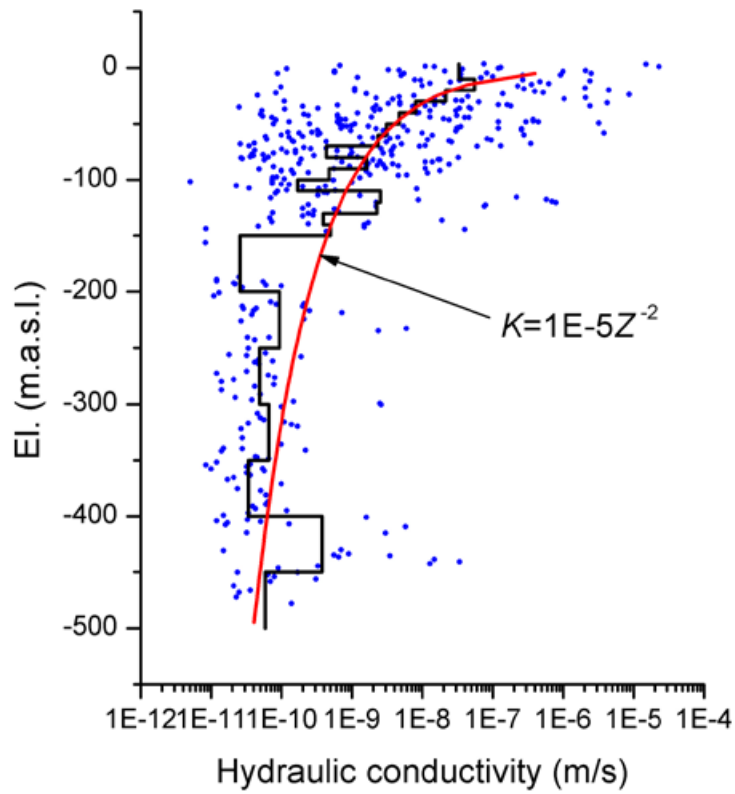

Figure 7-14. Depth dependency of hydraulic conductivity of background rock.

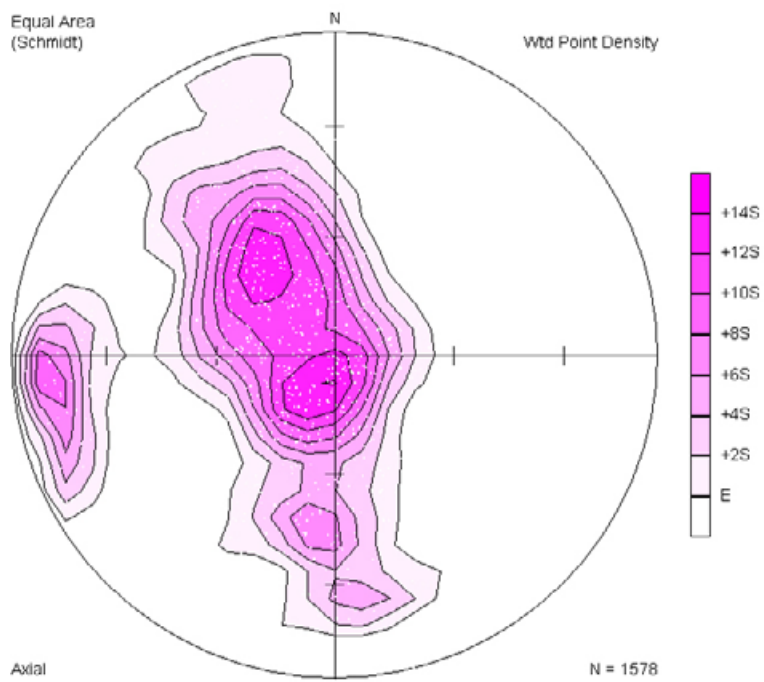

Figure 7-15. Orientation of observed background fractures.

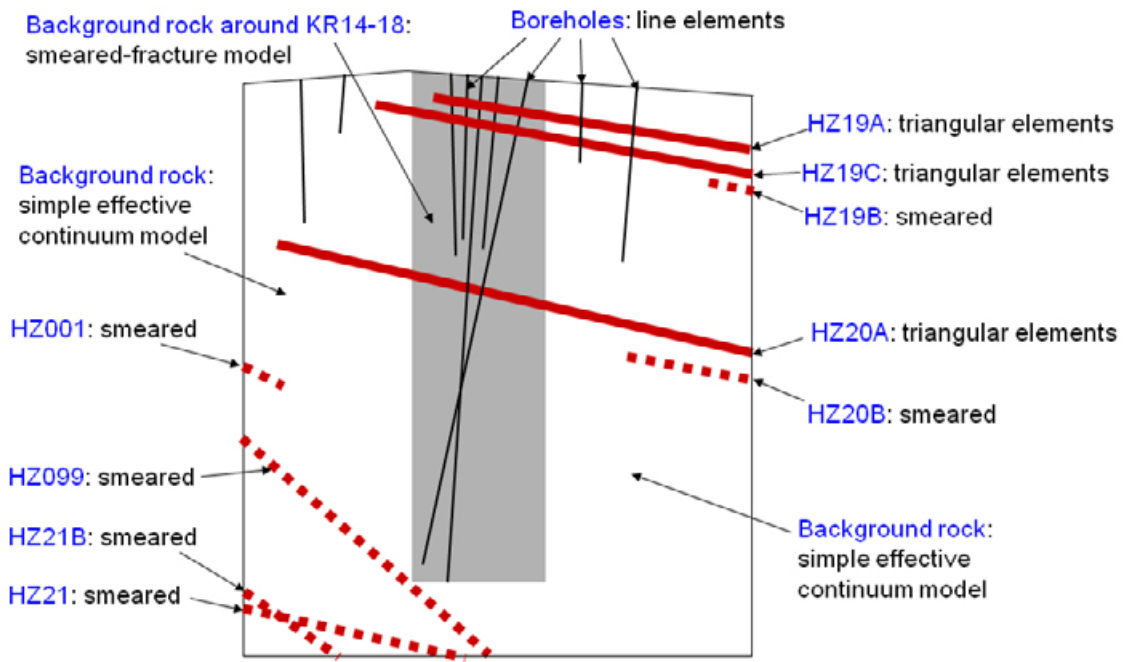
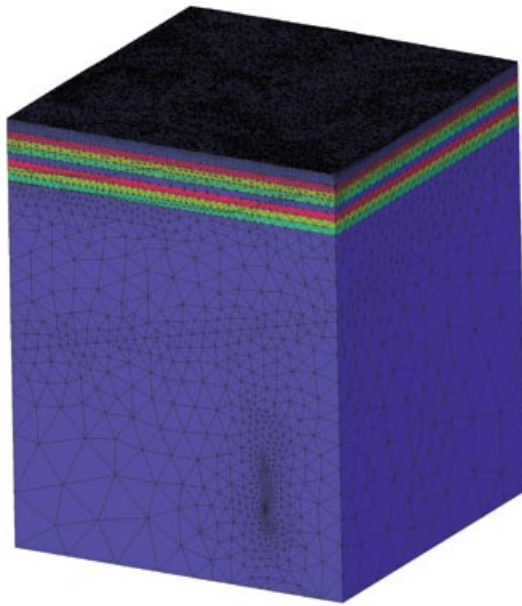
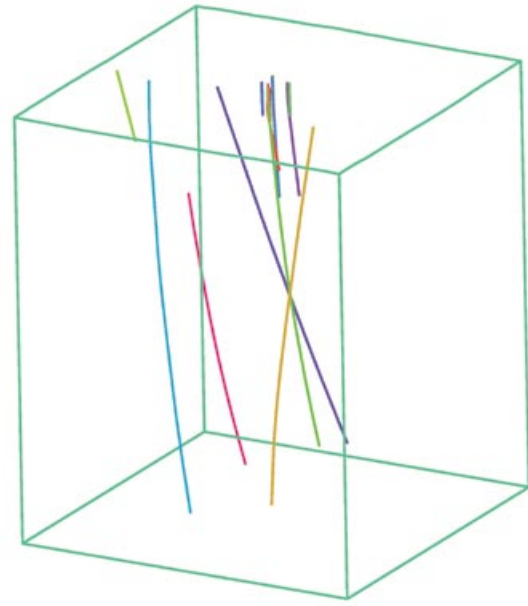

Figure 7-16. Numerical representation of hydrostructural model.



(a) Overall view



(b) Line elements

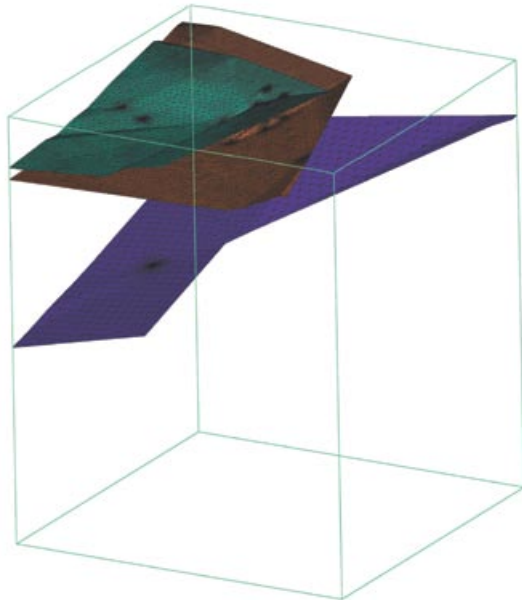

(c) Triangular elements

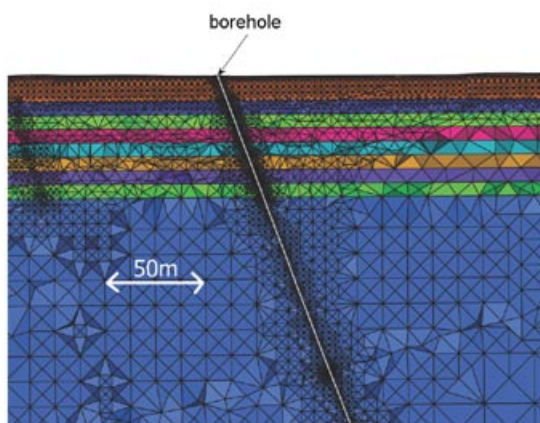

(d) Tetrahedral elements around a borehole

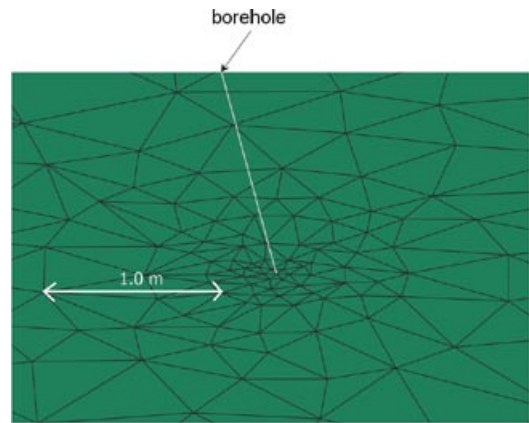

(e) Triangular elements around a borehole

Figure 7-17. Finite element mesh for numerical simulations of task 7B.

7.4.2 Task Force on Engineered Barrier Systems

CRIEPI has been developing the thermal-hydrological-mechanical (THM) coupling code Lostuf for evaluating the phenomena that will occur around engineered barrier systems. In 2008, the Lostuf code was applied in Benchmark 2 to the Canister Retrieval Test (CRT) performed in Äspö HRL.

The CRT was started to demonstrate the capability to retrieve deposited nuclear waste if a better disposal solution is found. The CRT has also been used to carefully record the THM process besides proving the possibility for retrieval of the canisters. This makes it very suitable for modellers to investigate theories, used in their simulations, since the calculated results can be checked against experimental data. The CRT consisted of an electric heater installed in bentonite blocks and bentonite rings in a 8.55-m-deep by 1.76-m-diameter in-floor borehole. A concrete plug and 9 rock anchors overlaid the bentonite to provide a vertical restraint against swelling.

In Benchmark 2, THM processes in the CRT experiment are studied. In the first part, the buffer at canister mid-height is modelled in detail. The finite element mesh is shown in Figure 7-18. This model includes an inner slot between the canister and the buffer and two types of buffer material, which are bentonite ring and bentonite pellet, whose initial densities are quite different. An interesting subject is how well the mechanical homogenisation process by swelling is simulated. In the second part, the entire experiment is simulated. The finite element mesh for the entire model is shown in Figure 7-19. Surrounding rock mass is not included.

Results from modelling of canister at mid height are shown here. Figure 7-20 shows the output positions and the numbers indicate the distance from the centre axis of the canister. The temperature evolution is shown in Figure 7-21. Lines show the results of simulation and dots show the measured data. The simulation can reproduce the temperatures very well. In Figure 7-22 and Figure 7-23 the water infiltration to the buffer is shown. Figure 7-22 shows the evolution of relative humidity focusing on the early stage of the CRT experiment and Figure 7-23 shows the reduction of suction in the entire period of the experiment. Simulated water infiltration is slower than measurement especially in the region near the canister. Although constant intrinsic permeability of $2.0 \cdot 10^{-21} \text{ m}^2$ is assumed in this simulation, its value could become large because of expansion of buffer material. The evolution of vertical total pressure is shown in Figure 7-24. The total pressure increases with swelling of buffer, however, simulated increase of total pressure is faster than measured data. In our model vertical total pressure is calculated as counter force equivalent to swelling strain toward upper and lower element. The vertical pressure in the simulations can be higher because vertical displacements are fixed in the disc model. The simulations can reproduce the homogenisation process with swelling of buffer. The measured densities and the simulated dry density profile in buffer on the canister mid-height is shown in Figure 7-25.

More investigation is required in the determination of hydraulic properties of buffer materials and bentonite swelling model. We will continue to investigate them in 2009 and will also conduct simulations of the entire CRT experiment.

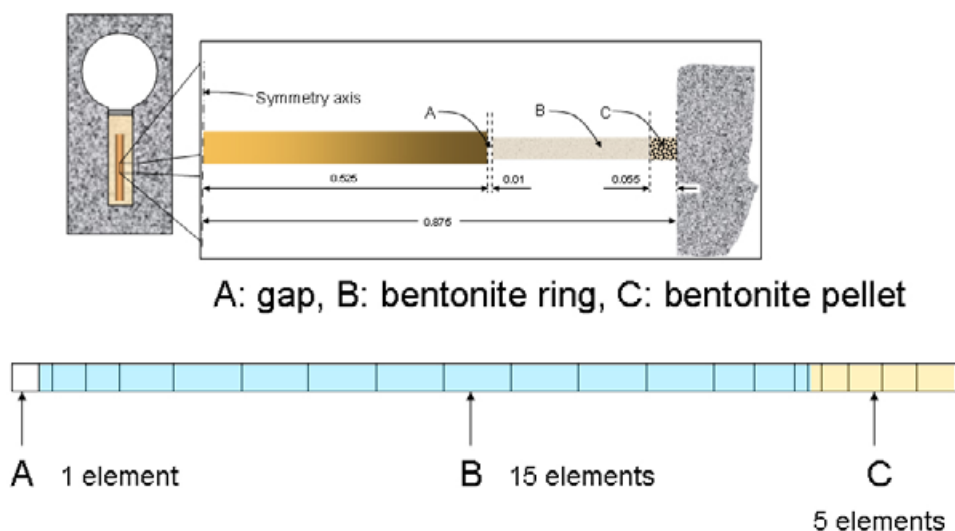

Figure 7-18. Finite element mesh at canister mid-height.

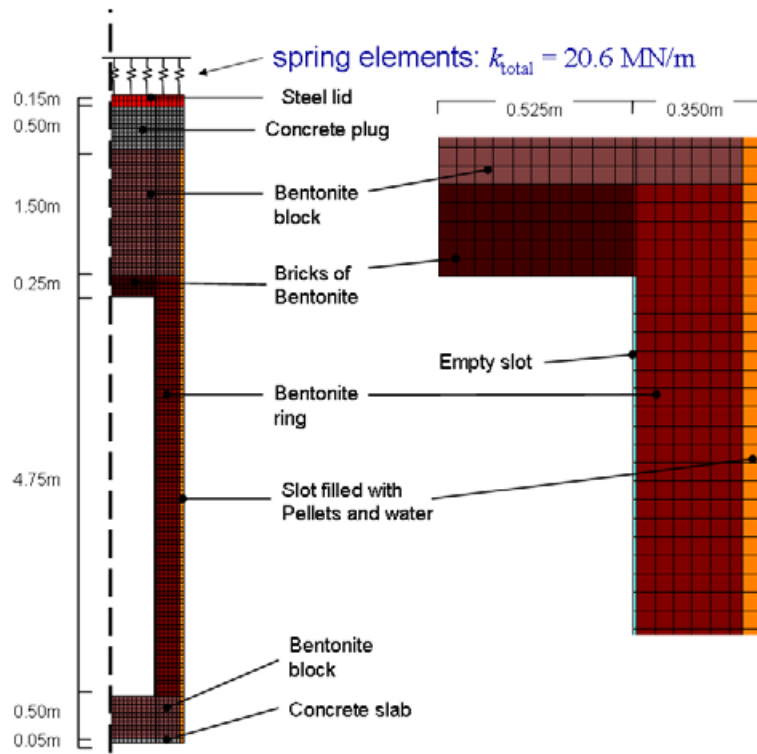

Figure 7-19. Finite element mesh of the entire CRT experiment.

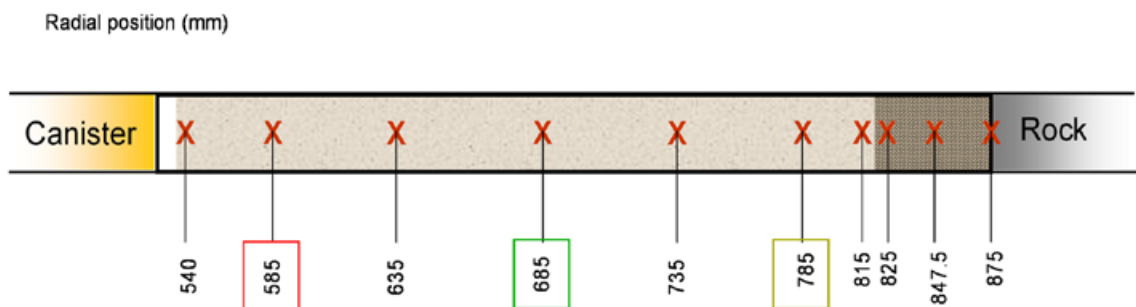

Figure 7-20. Temperature evolution in the buffer at canister mid-height.

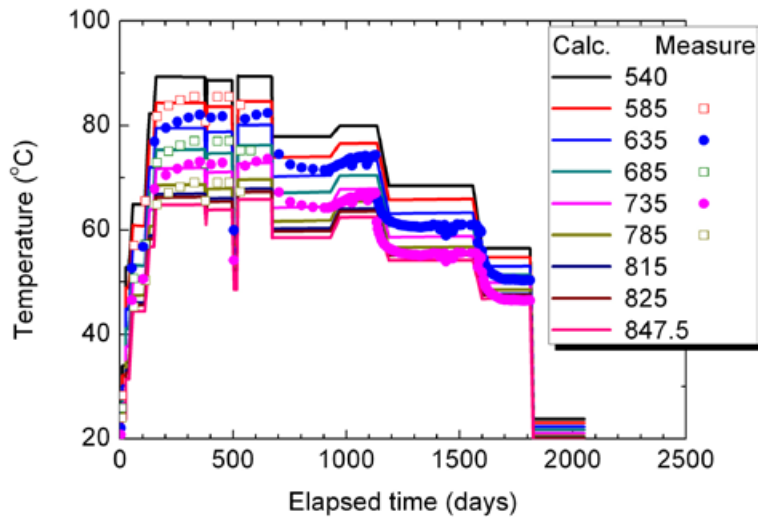

Figure 7-21. Temperature evolution in the buffer at canister mid-height.

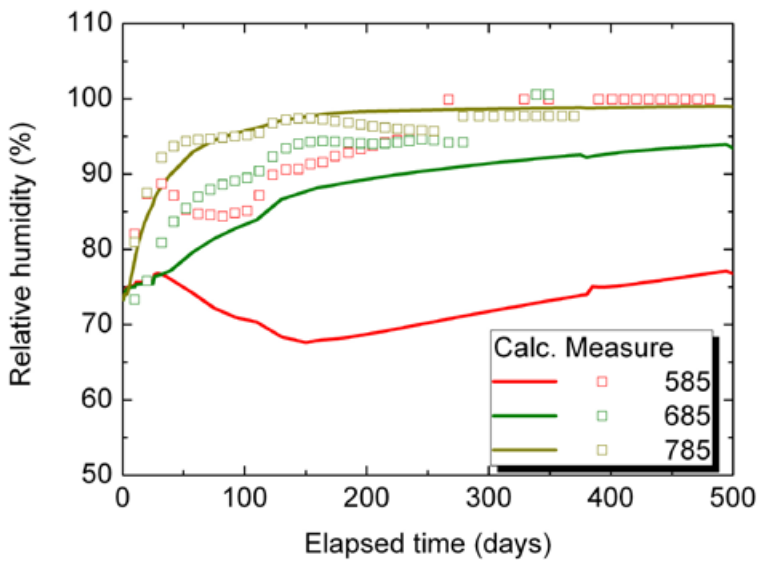

Figure 7-22. Relative humidity evolution in the buffer at canister mid-height until 500 days have passed.

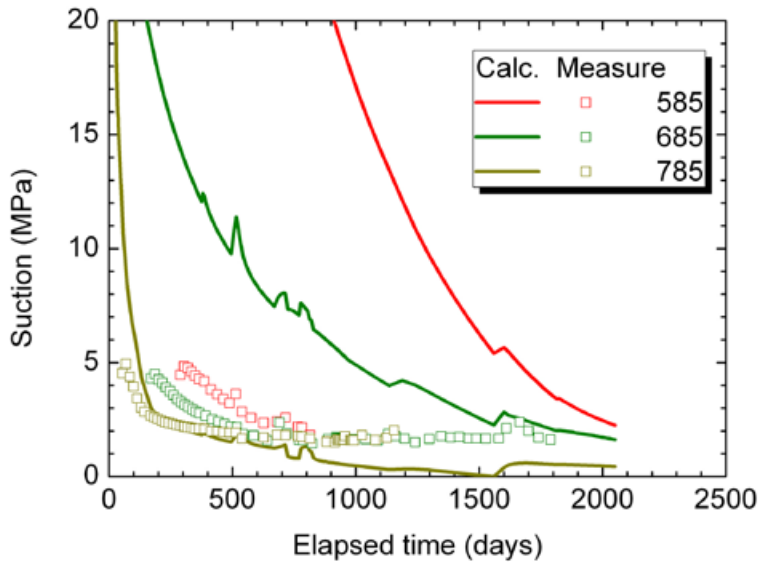

Figure 7-23. Suction reduction process in the buffer at canister mid-height.

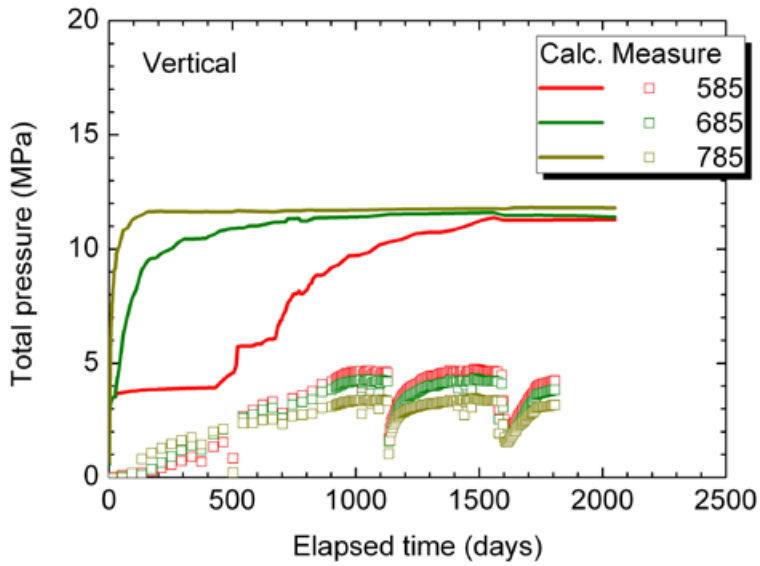

Figure 7-24. Total pressure evolution in the buffer at canister mid-height.

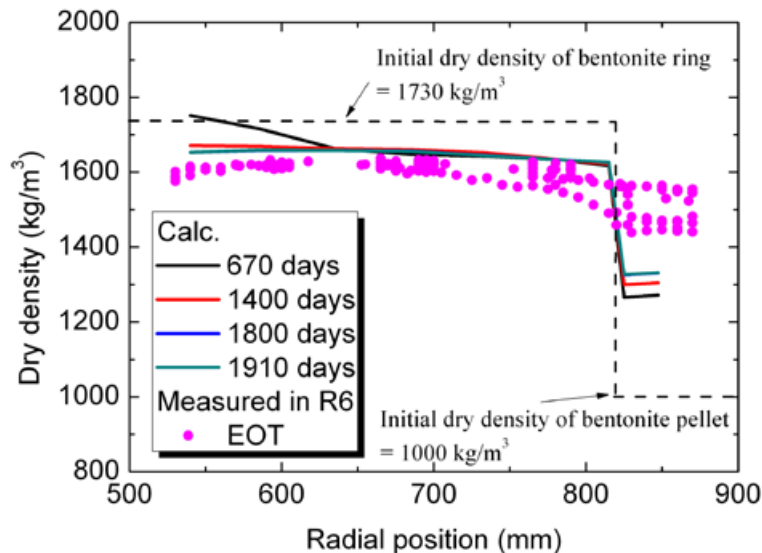

Figure 7-25. Distribution of dry density in the buffer at canister mid-height.

7.5 JAEA

The role of Japan Atomic Energy Agency (JAEA) in the Äspö HRL directly contributes to JAEA's mission as providing technical basis for repository site characterisation, safety assessment, and regulation in Japan. The Äspö HRL provides practical information that directly benefits JAEA's research and development activities, Japan.

JAEA research objectives at Äspö HRL during 2008 included the following:

- Improve understanding of site characterisation technologies, particularly flow logging and hydraulic interference.
- Improve understanding of flow and transport in fractured rock.
- Improve safety assessment methodologies.
- Improve understanding of underground research laboratory experiments and priorities.

These objectives are designed to support high level radioactive waste repository siting, regulation, and safety assessment in Japan.

7.5.1 Tracer Retention Understanding Experiments

JAEA has participated in the Tracer Retention Understanding Experiments (True) since 1997. During 2008, JAEA completed the preparation of a professional paper for the Journal of Hydrogeology describing work carried out as part of the Task Force on Modelling of Groundwater Flow and Transport of Solutes, using information and approaches developed as part of the True project. This paper is entitled "An empirical probabilistic approach for constraining the uncertainty of long-term solute transport predictions in fractured rock using in situ tracer experiments" and has been published online /Uchida et al. 2009/.

7.5.2 Task Force on Modelling of Groundwater Flow and Transport of Solutes

JAEA participation in the Äspö Task Force on Groundwater Flow and Transport of Solutes during 2008 focused on modelling for sub-tasks 7A and 7B, Long-Term Pumping Test at Olkiluoto, Finland. JAEA's goals from participating in Task 7 include an improved understanding of site characterisation and the reduction of uncertainty for hydrogeologic modelling, to contribute to both site assessment and safety analysis methodologies.

During 2008, JAEA completed modelling and reporting for sub-task 7A, presenting a detailed hybrid discrete fracture network/continuum model at the scale of Olkiluoto site. JAEA also initiated modelling for sub-task 7B, which focuses on the rock block scale (approximately 500 m) within the context of the sub-task 7A model of larger scale fracture zones.

Sub-task 7B – Hydrogeologic modelling at rock block scale

Sub-task 7B considers an approximately 500×500 m region surrounding boreholes KR14–18 at the Olkiluoto site in Finland. The fundamental objectives of the task are to:

- Quantify the reduction of uncertainty in the properties of the fracture network.
- Assess the Posiva Flow-logging (PFL) data when analysing the rock mass and fractures.

During 2008, JAEA participated in a workshop meeting in Oxford, UK, on the 13th–14th of May to establish the modelling strategies to match with the technical requirements for sub-task 7B. The work performed in sub-task 7B were performed in the three steps described below. Results of the analyses performed were presented at the 24th Äspö Task Force Meeting, on the 9th–11th of September, 2008.

(1) Conceptualisation of the background fracturing by analysis of flowing features identified in boreholes within the model region

The JAEA’s concept for sub-task 7B1 includes a stochastic population of background fractures represented by discrete features, and derived directly from Posiva flow logging (PFL). This population was found to be significantly different from the Olkiluoto-island scale fracture population evaluated by Posiva, see Figure 7-26. The following background fracture analyses were carried out during 2008:

- Analysis of fracture orientation to define sets and preferred orientations from flowing features identified in PFL within the model region
- Derivation of fracture transmissivity distributions from PFL measurements
- Derivation of fracture size distributions from lineament mapping, hydraulic interference, and from correlation to transmissivity
- Analysis of the spatial pattern of background fractures based on borehole intersections as identified in PFL.

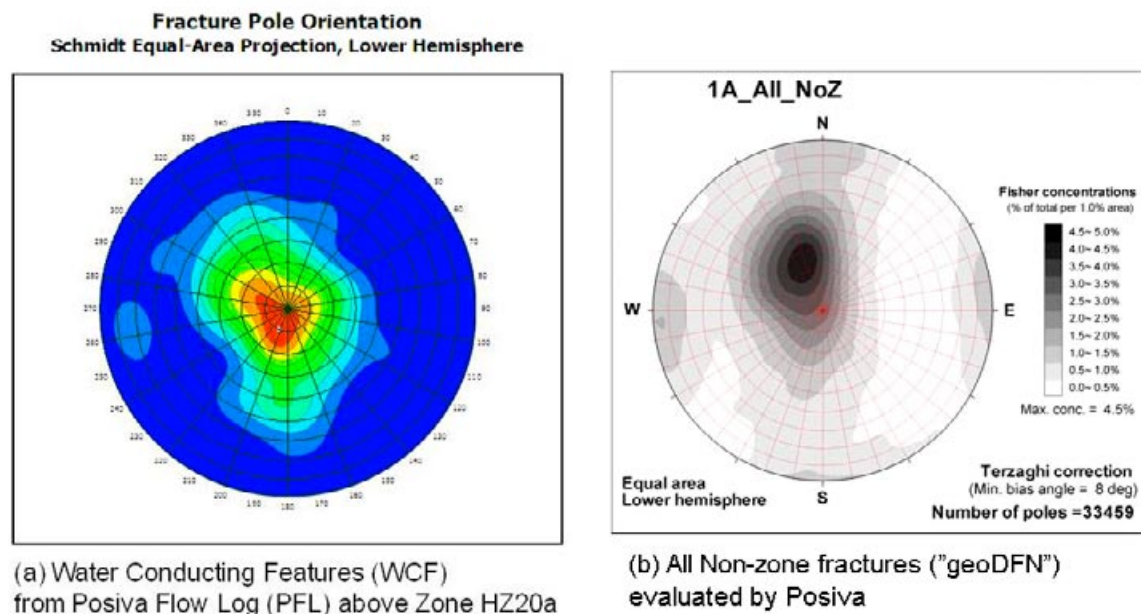

Figure 7-26. Comparison of stereographic projections for water conducting features above zone 20 with a “geoDFN” model evaluated by Posiva.

(2) Conceptualisation of the properties and connectivity of faults and fractures in the model region by analysis of transient hydraulic test data

During 2008, JAEA evaluated hydraulic interference tests carried out by Posiva within the model region to understand the hydraulic properties and connectivity of faults and fractures. This analysis used derivative plots of the transient pressure data to map the spatial pattern of hydraulic connectivity and boundary conditions.

Example of data from pressure recovery tests in KR17 and KR18 used for the analyses is shown in Figure 7-27. Three test phases are used for the preliminary analyses: (a) phase 3 injected from KR18 (53.5–59.5 m), (b) phase 4 injected from KR17 (49–51 m) and (c) phase 4 injected from KR17 (123.5–125.5 m).

Based on these analyses, JAEA derived a model for the connectivity of deterministic flow features shown in Figure 7-28. The sub-task 7A (so called “old” or “2006 model”) model for structures HZ19C and HZ002 are not sufficiently conductive to reproduce observed radial flow, between “old” structure HZ19C and HZ002 in boreholes KR16, KR17 and KR18. This model also has limited (thin) connection to KR15 and no major connection to KR14. This indicates the need to include a conductive zone between “old” structure HZ19C and HZ002. This zone could be a homogeneous, two dimensional planar feature, which is consistent with “unison” pressure response zone observed during the pressure response tests.

Figure 7-29 shows the comparison of the modified sub-task 7B hydrostructural model shown by Posiva for the sub-task 7B region with the conceptual model based on analysis of hydraulic interference tests. The modified HZ19C seems to represent a larger conductive feature estimated by the derivative plot analysis. The HZ002 has also been removed in this modified sub-task 7B model. However, some form of structure similar to HZ002 needs to be considered to provide observed connectivity at the depth of 70–80 m.

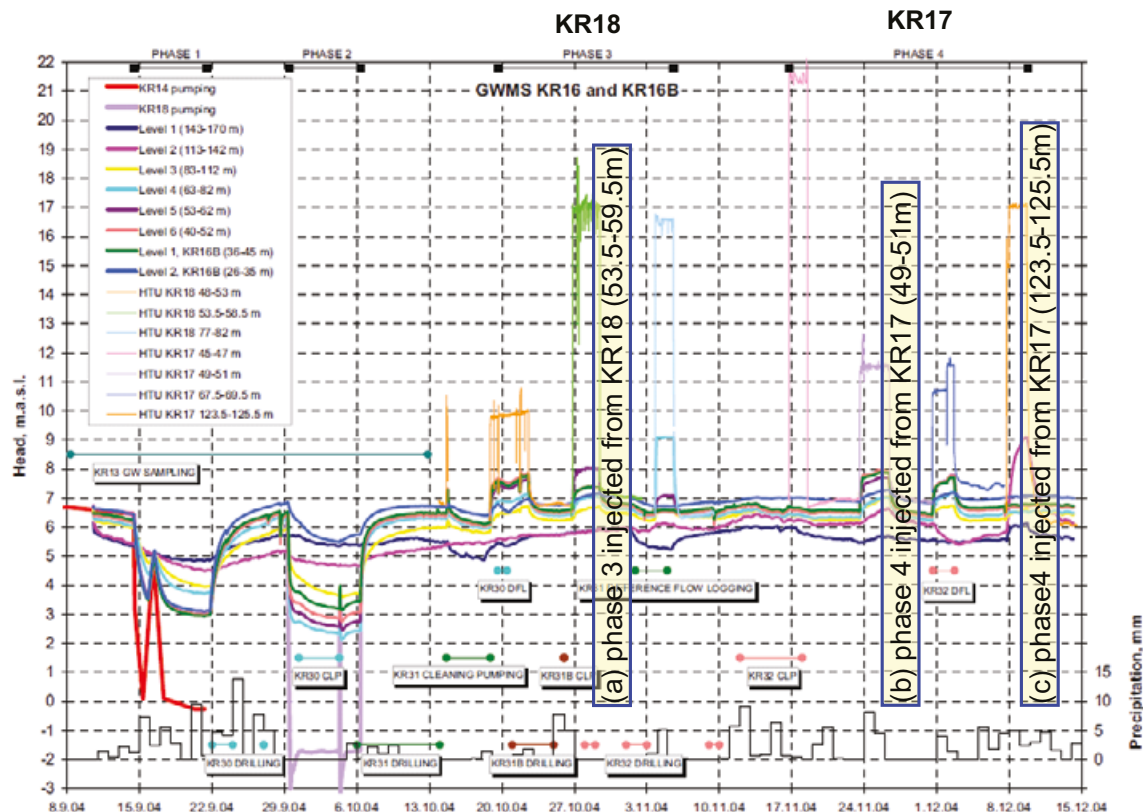

Figure 7-27. Pressure recovery tests used for the derivative plot analysis.

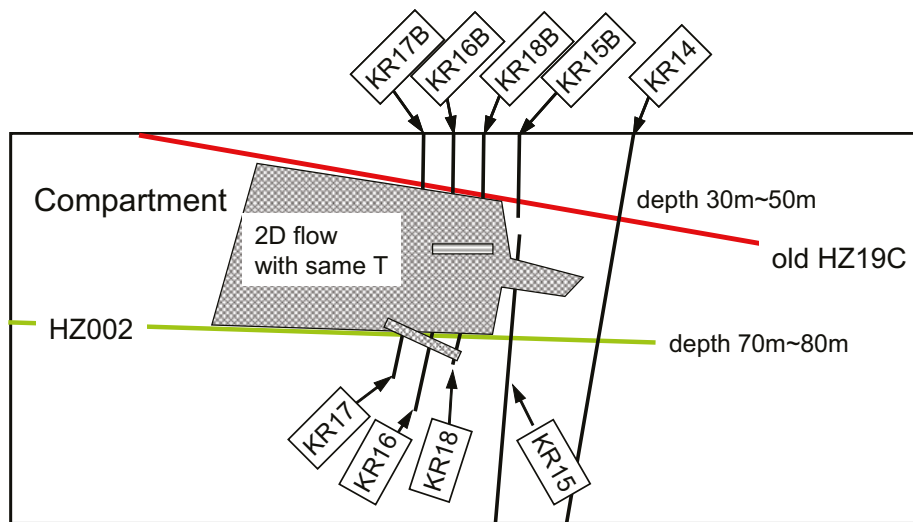

Figure 7-28. Hydrostructural model based on analysis of hydraulic interference data. “Old” HZ19C and HZ002 are faults in the sub-task 7A reference model.

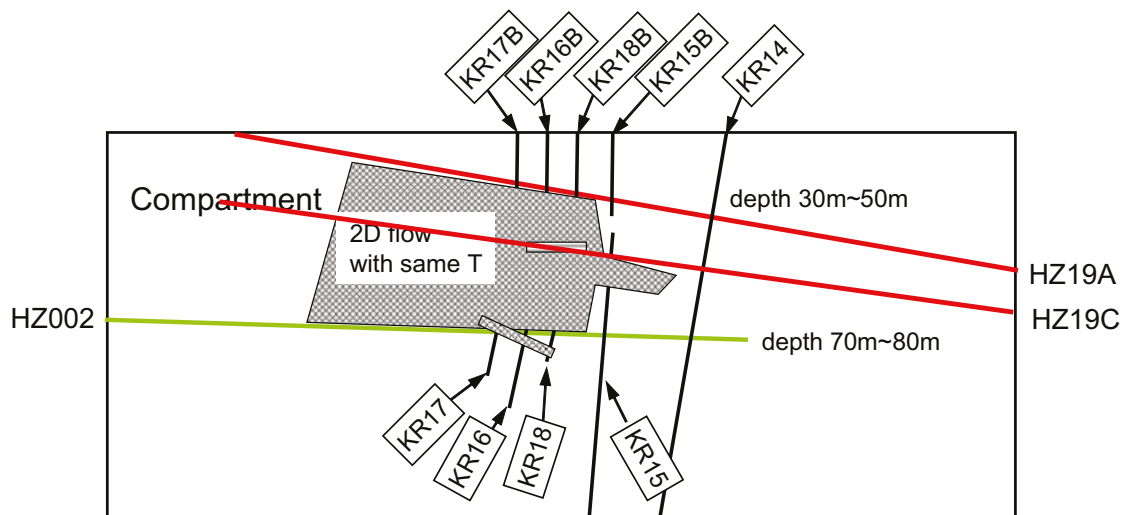

Figure 7-29. Comparison of sub-task 7A and revised hydrostructural models. HZ002 was removed from the revised reference model to improve the match to hydraulic interference tests studied.

(3) Sensitivity studies to evaluate the effect of local fault geometry, including both the sub-task 7A deterministic fracture zone (2006 model) and Posiva’s updated 2008 deterministic fracture zone model.

Three alternative conceptual models for deterministic faults within the sub-task 7B region were evaluated as shown in Figure 7-30: (a) reference model 2006 used for sub-task 7A, (b) reference model 2008 used for sub-task 7B and (c) modified 2008 model, with adding HZ002 to provide the observed connectivity at the depth of 70–80 m. This analysis was carried out using the simplified boundary condition described in Figure 7-31.

The alternative conceptual models were evaluated by carrying out steady state flow simulations both without disturbance such as pumping and with pumping for a series of the pressure interference tests, and comparing the flow response data and pressure response data. The relative model plausibility was estimated using the residual sum of squared errors normalised by number of compared points as:

$$\frac{\sum (measured - simulated)^2}{n - 1}$$

Figure 7-32 presents an example of this analysis, comparing the residual sum of squared errors for the 2006 model, 2008 model, and modified 2008 model. Two measures are shown. The height of the column represents the residual sum of squared errors normalised by number of compared points. According to this measure, the 2008 model provides the best match to measurements, since it has the lowest residual error. The “n” count provided on each column represents number of compared in situ measurements points along the boreholes matched by the model. According to this measure, the modified 2008 model is more plausible, because it include structures at a larger number of locations (58 measurements). Neither the 2006 model (27 measurements) nor the 2008 model (29 measurements) include a comparable number of connections to the measured boreholes.

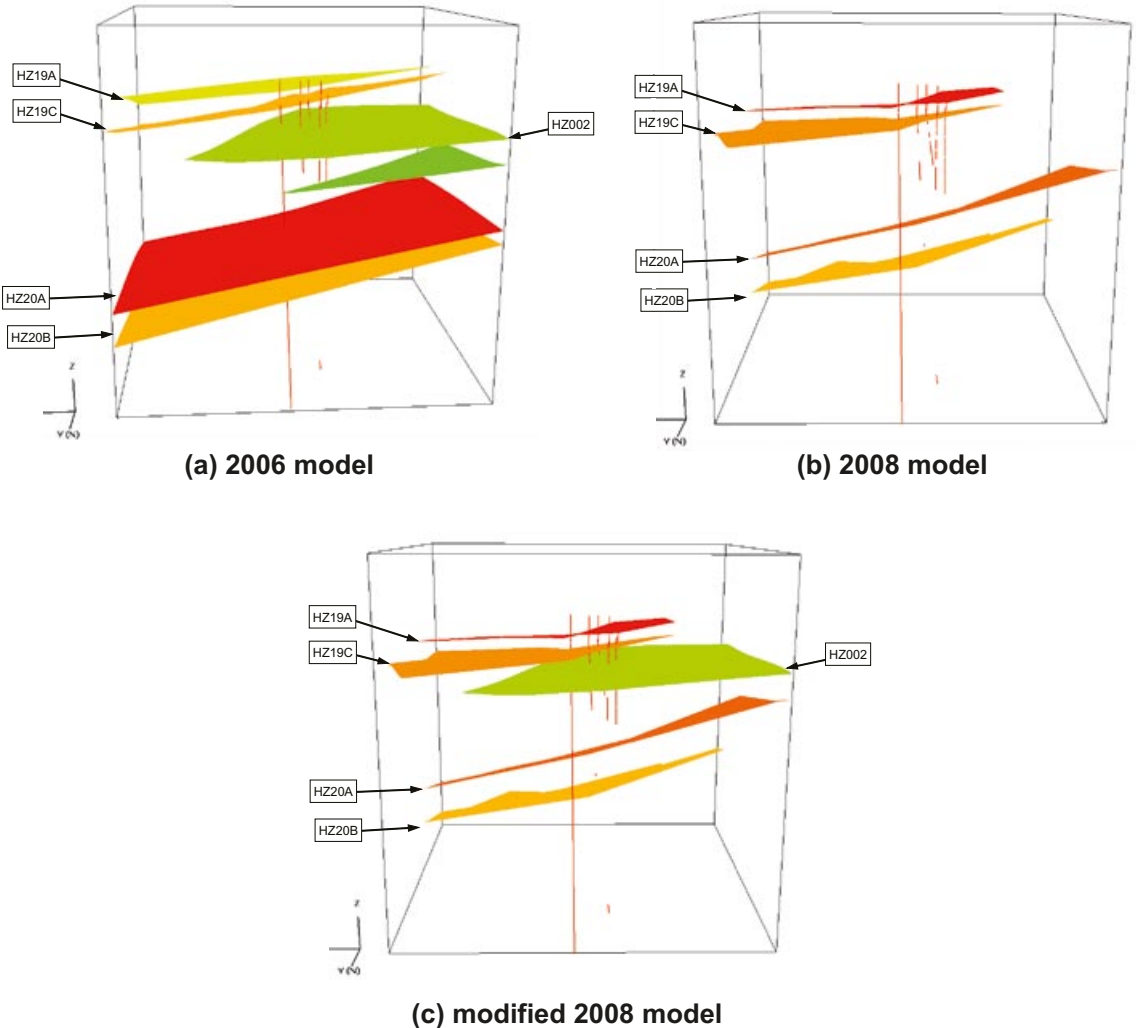

Figure 7-30. Alternative fault hydrostructural models evaluated in this study.

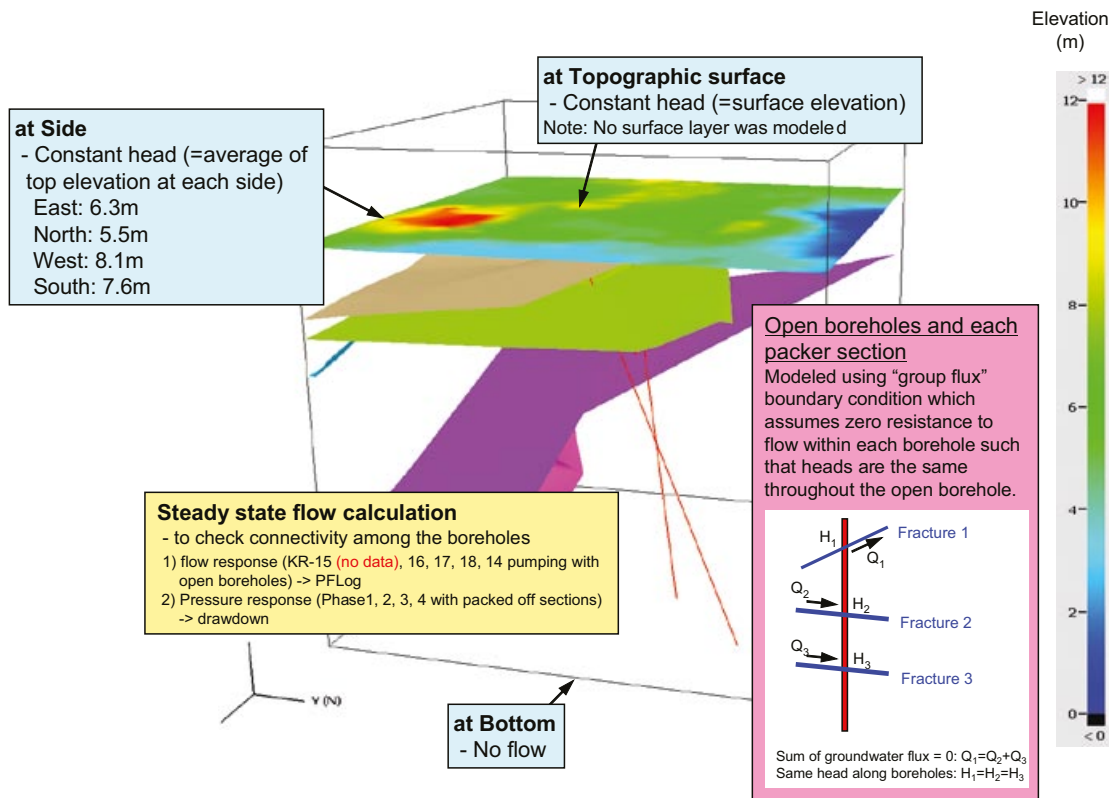

Figure 7-31. Boundary conditions and model assumptions used for the sensitivity studies to evaluate the effect of local fault geometry.

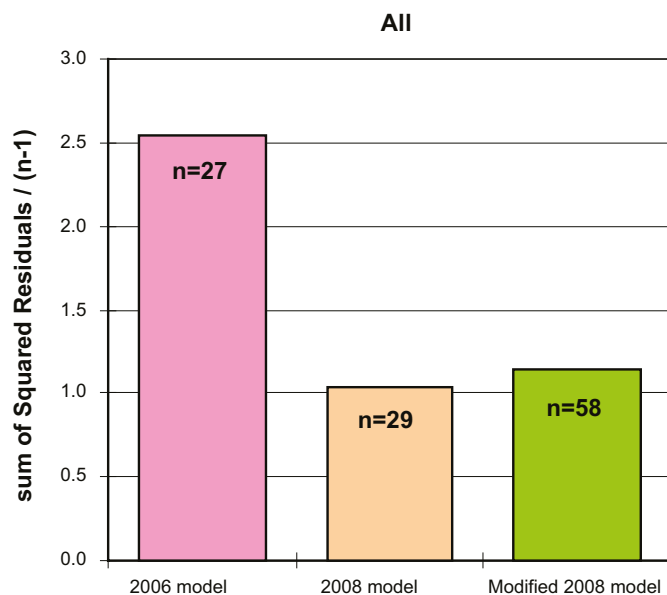

Figure 7-32. Example comparison of alternative models against hydraulic interference test measurements.

7.6 NWMO

In 2008, support to projects under the Äspö Project Agreement was performed on behalf of the Nuclear Waste Management Organization (NWMO) by Atomic Energy of Canada Limited (AECL), Université Laval and Intera Engineering. The results of this work are briefly described below. In addition, NWMO also worked with SKB to support the development of the proposed Rock Shear Experiment (Rose).

7.6.1 Colloid Transport Project

The goal of the Colloid Transport Project is to gain insight into the potential and significance of erosion of clay-based buffer and backfill materials if dilute water was able to reach a deep repository, such as in a glacial meltwater intrusion scenario. This experiment is being undertaken collaboratively with SKB in support of their bentonite colloid programme and also the in situ Colloid Formation and Migration (CFM) experiment being planned at the Swiss Grimsel test site.

In 2008, an experimental plan was developed and initiated to undertake a block-scale experiment to study bentonite erosion from compacted bentonite borehole plugs intersecting a natural fracture, and the subsequent transport behaviour of bentonite colloids in the fracture. The experimental plan called for an initial mock-up test in a transparent synthetic fracture (Figure 7-33) to test the preparation and installation of a bentonite plug in a borehole intersecting the fracture, to provide insight on plug expansion, gel propagation and erosion mechanisms, and to determine if fluorescent latex colloids mixed in the bentonite plug could serve as a suitable indicator of bentonite colloid behaviour in a fracture. The findings of the mock-up test would be used for planning the actual bentonite erosion experiment in the Quarried Block.

The protocol for the mock-up tests included different bentonite clay samples, water chemistries, latex colloid diameters, flow rates, fracture apertures and fracture angles.

The results from a series of mock-up tests provided a valuable contribution to the CFM project and resulted in significant changes to the design of the final block-scale test. The findings of the mock-up tests: (1) demonstrated that latex spheres can be used as a marker for bentonite erosion (Figure 7-34), (2) showed that mobile bentonite colloid concentrations were significantly less in Grimsel water compared to deionised water, (3) showed that gravitational forces affect bentonite erosion and transport (Figure 7-35) and (4) showed that bentonite deposits may alter groundwater flow in fractures.

Bentonite erosion and transport experiments in the Quarried Block fracture will be completed in 2009.

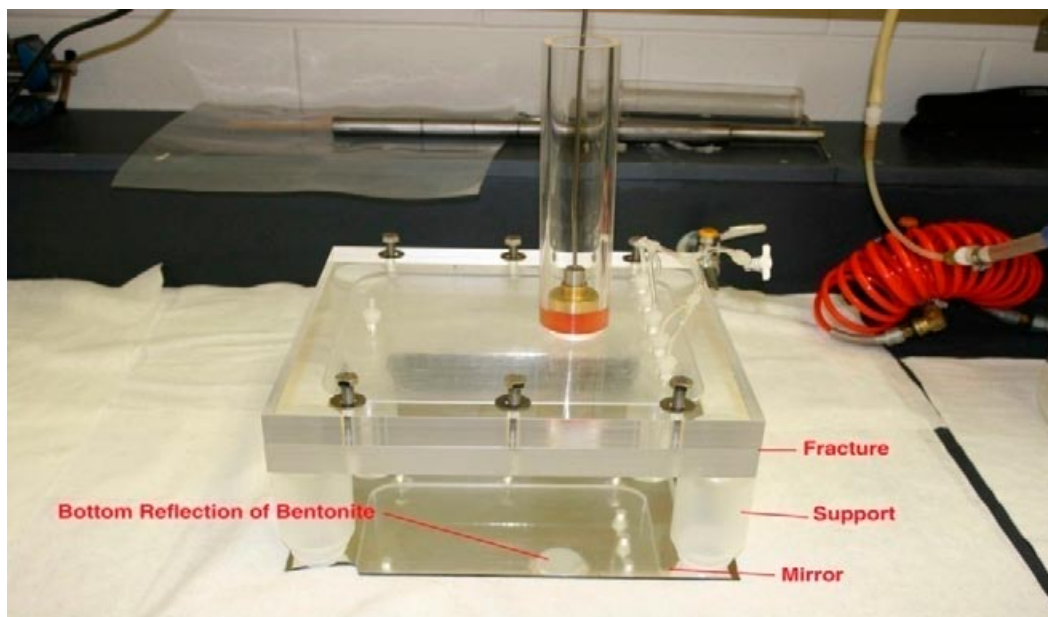

Figure 7-33. Mock-up of fracture and borehole intersection showing inlets on the right and outlet on the left, and borehole packer to contain the bentonite plug.

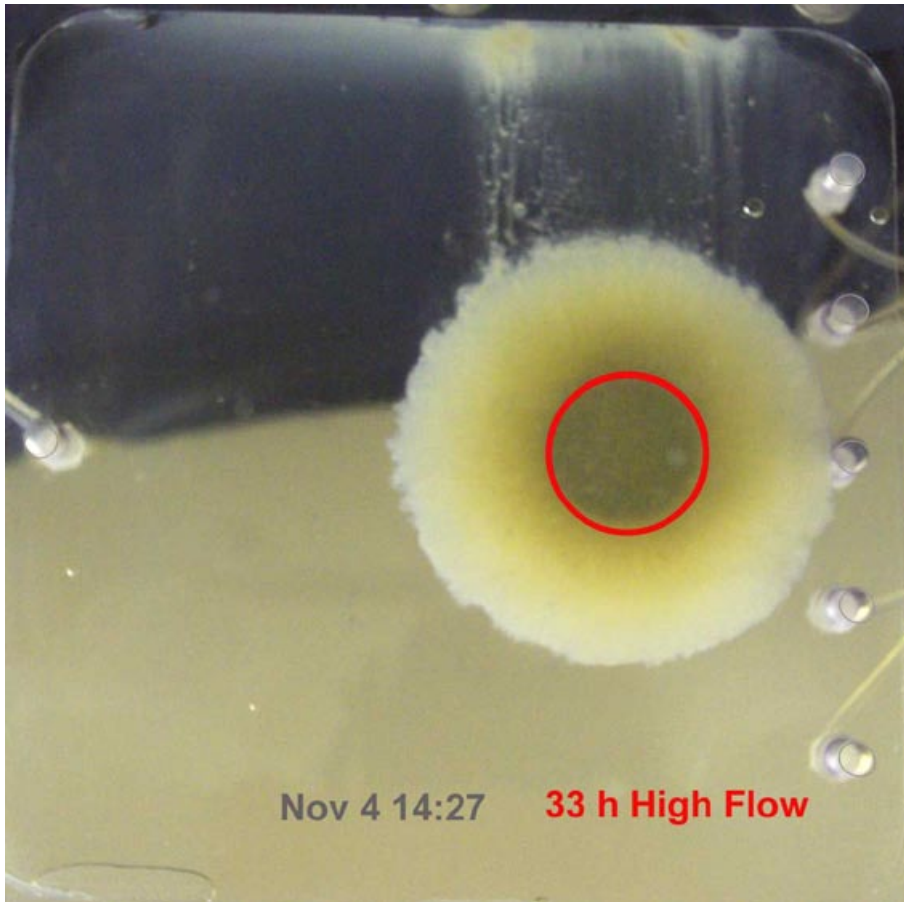

Figure 7-34. View from the bottom of the mock-up showing expansion and movement of Na-exchanged bentonite into a 1 mm fracture under high flow (44 mL/h) from right to left. Fracture down dip was 15 degrees to top of page.

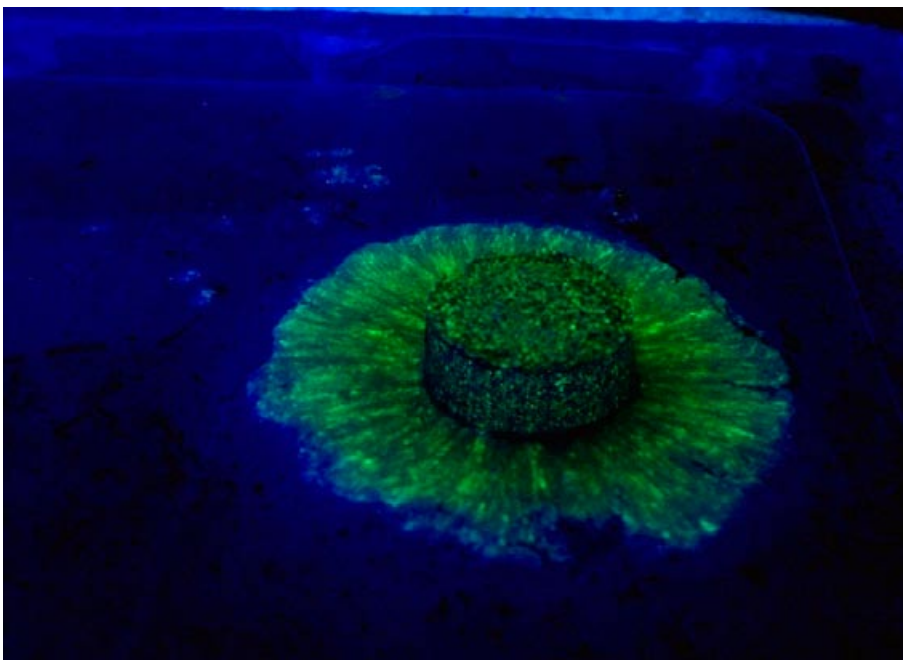

Figure 7-35. Uniform distribution of fluorescent latex spheres within the bentonite visualised during post-test analysis.

7.6.2 Task Force on Modelling of Groundwater Flow and Transport of Solutes

A modelling team from the Université Laval is participating in Task 7, which involves the numerical modelling of hydraulic responses in the fractured crystalline rock environment located on Olkiluoto Island in Finland. A large data set is available associated with investigations for Posiva's Onkalo underground rock characterisation facility. Task 7 modelling activities have been subdivided into two related sub-tasks: (7A) was focused on simulating a long-term pump test conducted in borehole KR24, which intersected a domain of several large, interconnected, fracture zones and (7B) considers smaller volume of an approximately 500 by 500 m² region surrounding a group of boreholes KR14–18 with a borehole separation on the order of 10 m. The modelling tasks involve simulating hydraulic responses in a series of interference tests completed at a block scale and in so doing quantify the reduction of uncertainty in the properties of the fracture network and further assess the contribution of Posiva Flow-logging (PFL) to the characterisation of the rock mass between the large fracture zones.

In 2008, the Laval modelling team participating in one Task Force meeting (TF#24 hosted by SKB at the Äspö Hard Rock Laboratory in Sweden) and one modellers meeting (held at the University of Oxford in United Kingdom). Activities in the Task Force focused on completion of sub-task 7A and initiating sub-task 7B modelling. The Laval modelling team, along with the other modelling groups, prepared final reports summarising their 7A modelling approaches and results. The Task Force secretariat also prepared a final evaluation report compiling and evaluating the results from all modelling groups.

The 2008 modelling activities for sub-task 7B focused on implementing and testing an approach to represent the heterogeneity of the geosphere using available site characterisation data sets. The Laval modelling team has adapted a transition probability-based approach with Markov chains (T-PROGS) to stochastically generate multiple realisations of equivalent porous media based on rock facies of variable fracture densities. Compilation of the data sets from the KR14 to KR18 boreholes, as well as 10 additional surrounding boreholes, resulted in the relationship between hydraulic conductivity and fracture density shown in Figure 7-36. This relationship can be used as an initial estimate of hydraulic conductivity distribution within the modelled domain, which is then further refined through inverse modelling using measured hydraulic test responses.

The Laval modelling team will continue to refine the application of T-PROGS to stochastically generate multiple realisations of equivalent porous media and complete the hydraulic simulations necessary to address the sub-task 7B performance measures development by the Task Force secretariat.

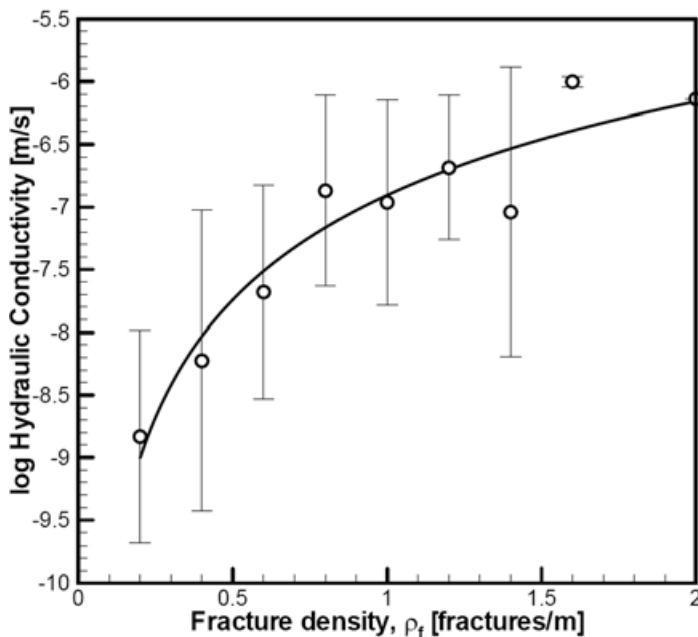

Figure 7-36. Preliminary relationship of hydraulic conductivity versus fracture density resulting from compilation of KR14 to KR18 and surrounding borehole data sets.

7.6.3 Large Scale Gas Injection Test

NWMO is contributing to the gas transport modelling in the Large Scale Gas Injection Test (Lasgit). All modelling is being conducted for NWMO by Intera Engineering. Previously, the Tough2 code was selected and modified for Lasgit to simulate pressure-induced changes in the properties, such as micro- and macro-fracturing. In 2006 and 2007, the modified code was applied to laboratory experimental data (MX-80-10 conducted by /Harrington and Horseman 2003/) and predictive simulations of the Lasgit experiment.

In 2008, modelling of the laboratory experiment was further refined with geostatistical heterogeneous permeability fields. Geostatistical heterogeneous permeability fields provide structure to a randomly generated permeability field, and were generated using Sequential Gaussian Simulation (SGS). These heterogeneous permeability fields improved the representation of gas outflow in the model in comparison to a homogeneous model, particularly with respect to the distribution of flow between the upper, middle and lower sinks, see Figure 7-37. The results also demonstrated that the gas outflow results are extremely sensitive to the allocation of higher and lower permeability zones, likely due to the use of what are essentially point sources and sinks in the laboratory experiment. The amount, distribution, and timing of outflows was strongly dependent on the local permeability near the injection and sink elements.

In 2008, attempts were also made to model the Lasgit experimental results for preliminary gas injection tests conducted in 2007. However, after analysing the experimental results and examining preliminary model results, it was determined that the pore pressure responses at the rock wall during the hydraulic and gas injection tests conducted in 2007 were either non-existent or probably the result of hydromechanical behaviour. The modified Tough2 code was designed to model gas breakthrough due to pressure-induced changes to bentonite properties. It is not capable of modelling hydromechanical processes, and the small pore pressure perturbation at the rock wall observed during the preliminary gas injection tests conducted in 2007 could not be modelled with the current Tough2-based Lasgit model. However, preliminary modelling highlighted required improvements to the Lasgit model for future modelling of gas breakthrough in the Lasgit experiment, particularly boundary and initial conditions. The preliminary work also indicates that improvements in the representation of injection assemblies and pore pressure sensors may also prove useful.

Future modelling in 2009 will improve the Lasgit model by improving boundary and initial conditions. Assuming the availability of results from hydraulic and gas injection tests to be conducted in 2009, attempts will be made to simulate results from these tests.

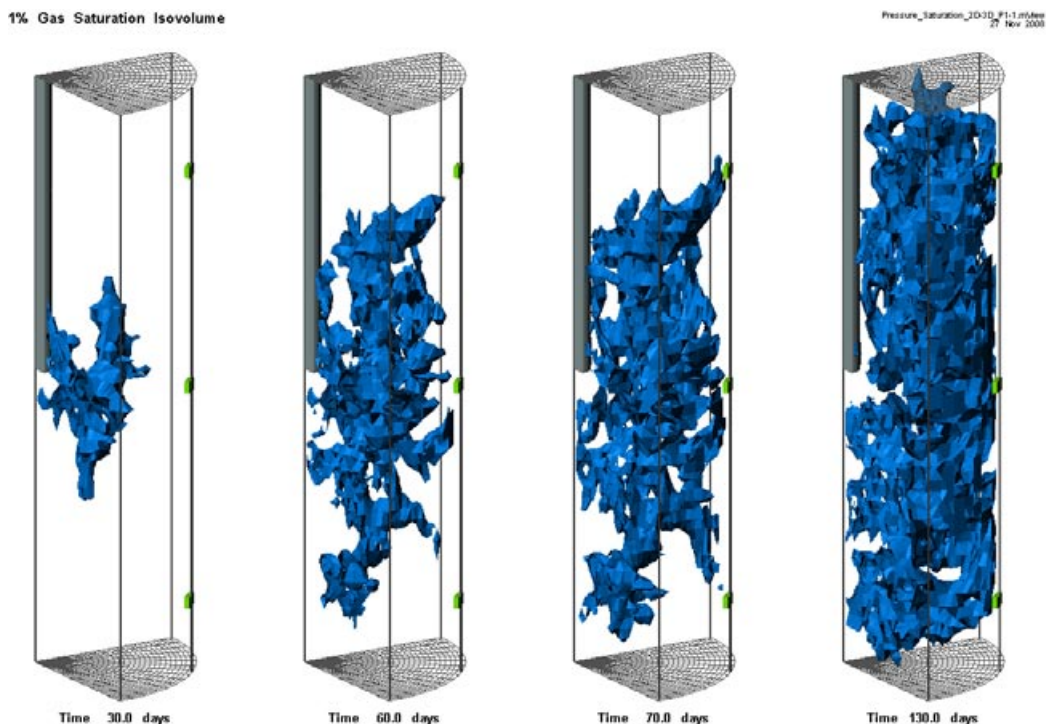

Figure 7-37. Gas saturation isovolume for heterogeneous permeability simulation. The figure shows the quarter section of model domain of the laboratory-scale bentonite sample, with gas injection point at the centre of the sample, and three gas sinks (green symbols) at the edge of the sample.

7.6.4 Task Force on Engineered Barrier Systems

Modelling of large scale field tests (Benchmark 2) is performed in this task force. At the end of 2007 AECL, acting on behalf of the NWMO, submitted their report on THM modelling activities focused on the completion of modelling of the AECL/NWMO supplied THM data from the Isothermal Test (ITT) and Buffer-Container Experiment (BCE) done at AECL's URL during the 1990's. These Canadian experiments were numerically modelled by a number of independent groups with the intention of gaining experience and confidence of various numerical codes to reproduce the observations gained by direct field experiments. Through this work it is intended to develop abilities to both reproduce field observations and ultimately develop confidence in the ability of these tools to predict longer-term behaviour of the engineered barriers system components lying beyond the container. In 2008 work on the ITT and BCE simulations was completed and a compilation of the results from the various modelling teams is to be prepared in 2009 as a project document by the Task Force secretariat.

In 2008 a new field test for the next stage of numerical simulation was selected. This field test is the Canister Retrieval Test (CRT) that was completed at SKB's Äspö facility during 2007 and the THM data collected in the course of this test have been made available for use by the Task Force. Using these data AECL/NWMO has initiated the modelling of CRT and preliminary results have been generated. The modelling of the CRT will be extended into 2009 to allow for further evaluation of the modelling results.

7.7 Posiva

Posiva's co-operation with SKB continues with the new co-operation agreement signed in the autumn of 2006. The focus of the co-operation will be on encapsulation and repository technology and on bedrock investigations.

Posiva also contributed to several of the research projects within Natural barriers. The implementation and construction of the underground rock characterisation facility ONKALO at Olkiluoto in Finland give possibilities to co-operate within the research and development of underground construction technology. The organisation is participating in the following projects:

- KBS-3 Method with Horizontal Emplacement
- Large Scale Gas Injection Test
- Sealing of Tunnel at Great Depth
- Long Term Test of Buffer Materials
- Alternative Buffer Materials
- Task Force on Modelling of Groundwater Flow and Transport of Solutes.
- Task Force on Engineered Barrier Systems
- Bentonite laboratory

Posiva's co-operation is divided between Äspö HRL activities and more generic work that can lead to demonstrations in Äspö HRL. The work performed during 2008 is described below.

7.7.1 Task Force on Modelling of Groundwater Flow and Transport of Solutes

In 2008, the Äspö Task Force ongoing Task 7 concluded the site-scale modelling with the evaluation and the extensive discussion of the participants' contribution and moved on to the block scale, targeting to characterise and better understand a series of interference tests, which were performed in 2002 and 2004 in boreholes KR14 to KR18. The main goal of this modelling endeavour was the numerical reproduction of the characteristic results of the hydraulic tests, with the focus on flow distribution, to be subsequently compared with the field data obtained with the Posiva Flow Log (PFL). The interference tests were performed in several setups varying the location of the pumping, monitoring head and flow in open and packed-off boreholes, etc.

The key of this modelling task is the successful creation of the connectivity field of the modelled rock volume between the hydraulic disturbance and the locations of the observations. This property of the rock is based on the geometry and the transmissivity distributions of the fractures, thus numerical tools addressing the objectives of this task are to be capable of developing Discrete Fracture Networks (DFN). In fact the current sub-task 7B is a major, state-of-the art DFN modelling endeavour, also discussing a lot of methodological issues besides the actual characterisation of the interference tests.

In 2008 the contribution of Posiva/VTT was the development and documentation of the VINTAGE (Virtual Integer Arithmetics to Generate Elements) DFN module as part of the FEFTRA program package, which creates the geometry and hydrogeological properties of DFN models from statistical distributions, converts them into a finite element models applies boundary conditions, solves the model for hydraulic head with existing finite element tools and then calculates derived result quantities like pathlines, flow rates, travel times and the WL/Q retention property.

This tool, together with its Equivalent Porous Medium (EPM) companion was applied in the ongoing sub-task 7B, comparison and the refinement of the results, as well as the calculation of the required performance measures are underway. Current findings include the position and the probable extent of an undocumented structure, which connects KR14, KR15b, KR16b and KR18b.

An article on Task 6 has been submitted to Hydrogeology Journal /Hodgkinson et al. 2009/. Task 6 showed that retention properties inferred from an in situ tracer experiment cannot be directly applied to the performance analysis of a spent fuel repository.

7.7.2 Long Term Test of Buffer Material

Posiva's task in the Long Term Test of Buffer Material project is to study the porewater chemistry in the bentonite. The task is carried out at VTT. The aim of the work is to obtain data on the chemical conditions which develop in the bentonite considering the effect of temperature, additives and rock features. The study gives information about the chemical processes occurring in the bentonite, but also supports the other planned studies of chemical conditions.

In the year 2008, cation exchange capacity measurements (CEC) of bentonite samples from the retrieved parcel A2 were repeated because a systematic increase of the CEC in the hot area was noticed in the analyses performed by Clay Technology AB. The new results show increased CEC but also increased scattering in the measured values of the hot area.

7.7.3 Alternative Buffer Materials

Posiva joined the Alternative Buffer Material (ABM) project in the year 2007. The clay materials of interest in the Posiva's studies are MX-80, Deponit, Asha and Friedland Clay. The focus of the work to be carried out at VTT is on the chemical processes occurring in the bentonites. In the year 2008, work comprised studies with the reference materials. The aim of those studies was to get information about the materials before they have been in the field experiment and to test the research methods, which will be used when the packages have been retrieved. Laboratory experiments were performed with the bentonite materials of ABM in order to study the total porosity, the porosity available for chloride as a function of clay density, and pore structure with XRD and SAXS measurements. Cation exchange capacity (CEC) of the clays and dissolving components, pH and Eh in the porewater were also studied.

7.7.4 KBS-3 Method with Horizontal Emplacement

SKB and Posiva are engaged in an R&D with the overall aim to investigate whether the KBS-3H concept can be regarded as a viable alternative to the KBS-3V concept. The project is jointly executed by SKB and Posiva and has a common steering group. Present stage is complementary study stage, 2008–2010, where the target is to solve a number of pre-designed issues and conduct component tests in the field and select the most appropriate design. Also it will be planned full-scale system tests in a representative environment.

Posiva's responsibility in the new project phase is to develop further the design so that a reference design can be selected, this means also solving of the identified remaining buffer related critical

issues by laboratory testing and modelling. Posiva's safety case studies focus on the studying of alternative materials (Fe, Ti, Cu) for the Supercontainer and their possible impact on the safety function of the buffer, and by evaluating the consequences of the perturbed buffer rock interface. The work also includes setting up of long-term safety requirements for the developing design.

7.7.5 Large Scale Gas Injection Test

The first phase of the Lasgit project was successfully completed at the end of the year 2007. At that time a decision to continue the gas injection experiment with a new hydration phase was done. The related issues have been pursued within the preparation of an EU project, Forge.

7.7.6 Sealing of tunnel at great depth

Sealing of the tunnel at great depth. The project was implemented due to gather information on applicability of colloidal silica for the sealing purpose at the disposal depth with high groundwater pressure and to show that leakage requirements can be fulfilled by acceptable materials and methods. Posiva participated in the reference group of the project. The main part of the project came true during 2008, with totally 6 grouting fan. The Tass-tunnel was mainly grouted with colloidal silica, but in some cases the low pH cement grout was also used. The information exchange continued and the reference group of the project did visit at ONKALO site in Finland.

7.7.7 Task Force on Engineered Barrier Systems

The objective of the Task Force on Engineered Barrier Systems is to develop methods and tools for THMC analyses of buffer and backfill. The objective for the year 2008 was to continue the work of the previous years in improving the prediction capabilities of THM simulations and in establishing a common base for C-analyses.

With respect to THM simulations, the focus has been on simulating the Canister Retrieval Test (CRT) in Benchmark 2. The model employed in modelling THM behaviour of partially saturated compacted bentonite has been developed from a continuum thermodynamical description of an arbitrary mixture. The resulting set of equations is solved with a general purpose finite element solver, FreeFEM++. Using this approach some features of the test have been captured, like thermal and other uncoupled phenomena, but strongly coupled hydraulic and mechanical phenomena present in CRT have not been captured adequately. The main cause for these deficiencies is currently considered to arise from the simplifications implemented, like selection of certain conceptual models. To overcome these difficulties more work on theoretical aspects would be needed.

Regarding the chemical aspect, the most notable contribution has been development of an alternative conceptual approach, namely multi-porosity model. With the model implemented in PhreeqC selected physical experiments were reproduced. Furthermore, work has been considering the interpretation of bentonite microstructure based on XDR, SAXS and anion porosity measurements. The interpretations done suggest that there are pores of several different characteristic sizes.

7.8 Nagra

The Nationale Genossenschaft für die Lagerung Radioaktiver Abfälle, Nagra, has the task to provide scientific and technical basis for the safe disposal of radioactive waste in Switzerland. Nagra has had agreements with SKB for participation in Äspö HRL since 1994 to include mutual co-operation and participation in Äspö HRL and Grimsel Test Site projects. The last agreement expired 2003 and Nagra has now left the central and active core of participants.

Nevertheless, Nagra supports the Äspö activities and participates in specific tasks as shown below.

7.8.1 Alternative Buffer Materials

Bentonite samples from the Lot experiment were analysed by the University of Berne and pore-water extracted from the bentonite has been characterised. The results were presented in the Workshop in Lund (December 2008).

7.8.2 Task Force on Engineered Barrier Systems

Participation in the modelling meetings. The 8th EBS Task Force meeting was held on November 12–13, 2008 in Hergiswil/Switzerland. Nagra's activities concentrated on modelling of gas transport processes in compacted bentonite. A task report was delivered and a laboratory study on microstructural characterisation of compacted bentonite was presented in Hergiswil.

In addition, Nagra is supporting the newly formed group for the geochemical aspects within the EBS Task Force. In 2008, Nagra sponsored the participation of foreign experts to the meetings, co-sponsored the development of a dual porosity Crunch flow model and supported the overall management of this group via the University of Berne.

7.9 Rawra

Radioactive Waste Repository Authority, RAWRA, was established in 1997 and has the mission to ensure the safe disposal of existing and future radioactive waste in the Czech Republic and to guarantee fulfilment of the requirements for the protection of humans and the environment from the adverse impacts of such waste. RAWRA became a participant in the Task Force on Engineered Barrier Systems in 2005 and participates also in the Alternative Buffer Materials project.

7.9.1 Alternative Buffer Materials

In the frame of the project there were created two basic material models, later used in the modelling for the Task force on Engineered Barrier Systems using the Delphin code. The first model is representing material Febex, which is similar to bentonites of type Rokle in the Czech Republic. The second one is relevant to material MX-80. To use models for prediction of system performance, relatively extensive fitting is needed. Results for isothermal test and temperature modelling are presented in Figure 7-38.

7.9.2 Task Force on Engineered Barrier Systems

RAWRA has participated in Benchmark 1 (Laboratory tests) and the ongoing Benchmark 2 (Large scale field tests) of the EBS project. Three participants, one research institute and two universities took part in the model development and verification activities. In the case of Benchmark 1, the activities were supported with a wide research of alternative buffer materials and/or gas migration experiments.

The simulation code Iserit has been used for coupled heat and moisture transport in the modelling of the in situ bentonite heating and hydration experiment "Buffer-container experiment" performed by AECL (Canada). The proposed model uses mobile and immobile zone. The mobile zone represents the pores and the gas phase in them and the immobile zone represents the solid phase and the water sorbed in it. The transport is allowed in the mobile zone from one place to another and between mobile and immobile zone in one place. An example of modelled temperature contours is shown in Figure 7-39.

Even a simple model of linear heat conduction (effectively not coupled to water content) was able to well capture the measurement data. The differences 1–3° C can correspond to usual uncertainties and inhomogeneities. In some cases, the solitary difference can be explained by complicated conditions (e.g. shape of the heater top or large gradient).

Gas transport modelling through bentonite has been described and experimentally supported as a part of Benchmark 1. The transport processes in the model developed in GoldSim are being described using the scheme shown in Figure 7-40. The experimental equipment was proposed and operated in Nuclear Research Institute in conditions as shown in Figure 7-41.

It has been stated, that there exist more problems in gas modelling. In future, a Tough code shall be used in parallel to GoldSim to verify the simulation of gas transport processes. At present state, there have been found more difficulties in pressure curves e.g. in dependence on swelling pressure and breakthrough mechanism. More experiments will follow to verify models with relation to measured data.

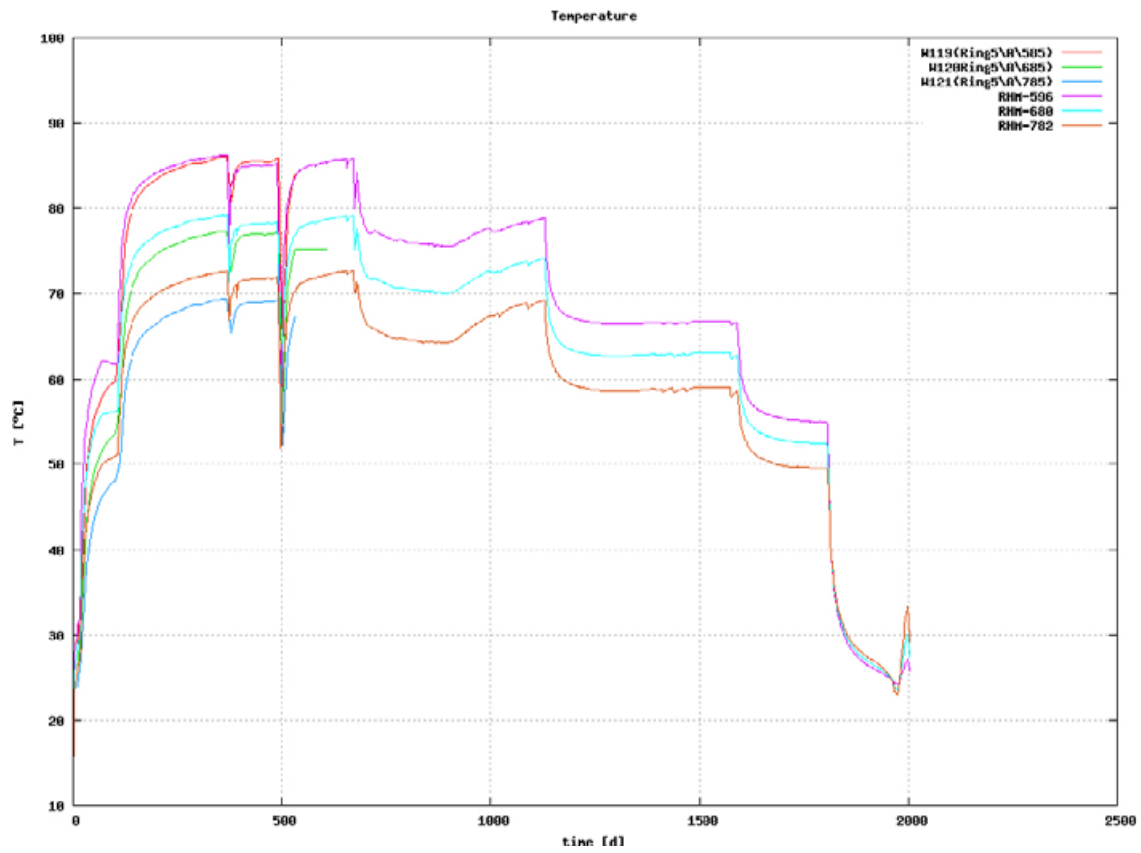
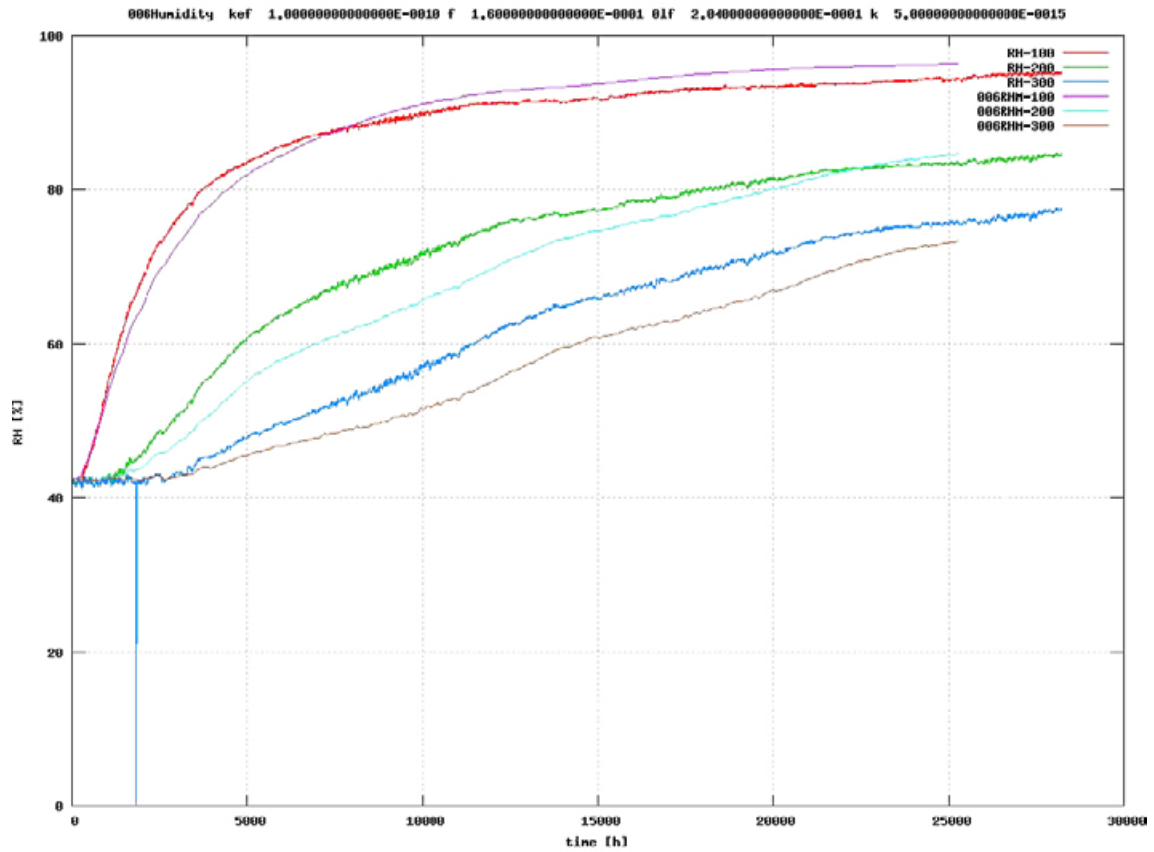

Figure 7-38. Example of results from isothermal test and temperature modelling.

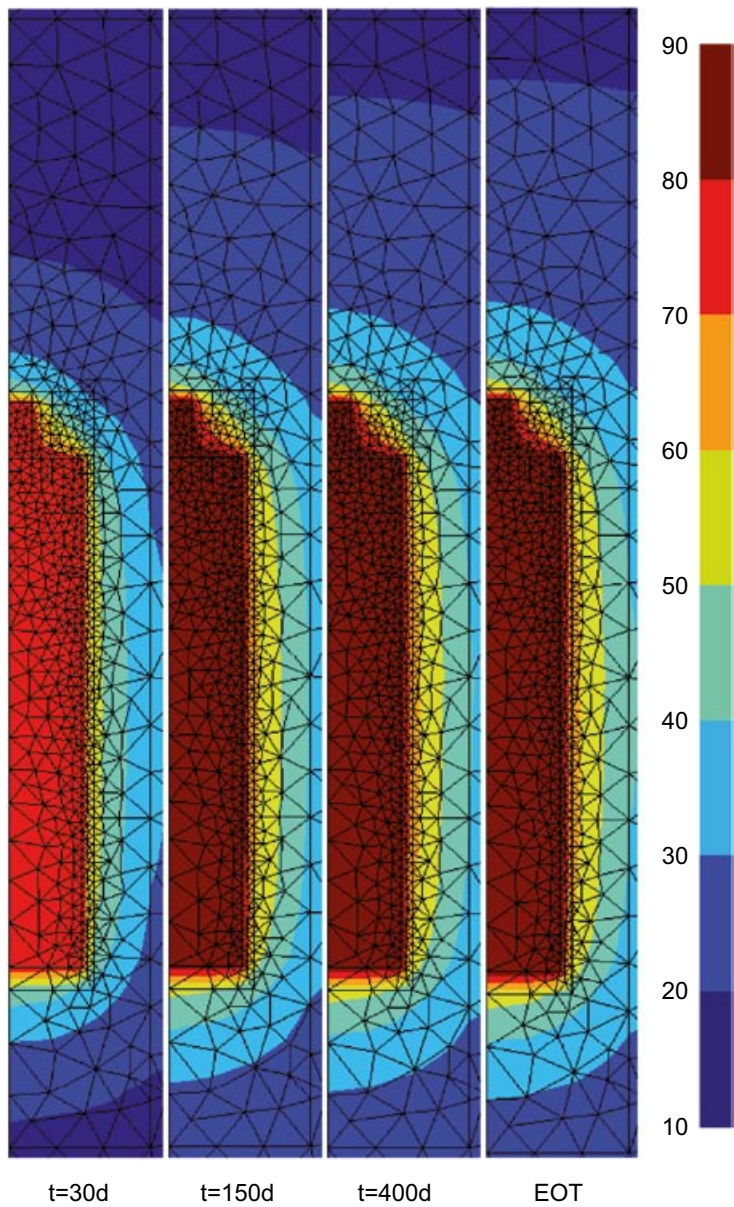

Figure 7-39. Modelled temperature contours for different times (the figure boundary corresponds to the buffer/rock interface).

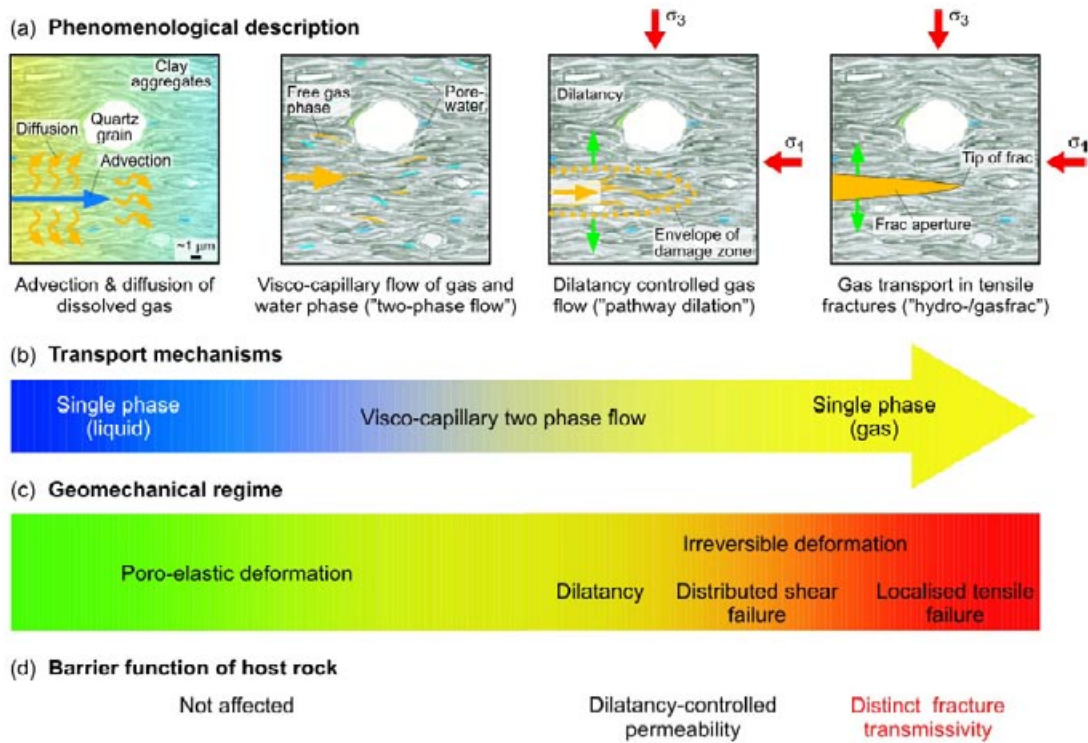

Figure 7-40. Scheme showing the transport processes in the model developed in GoldSim.

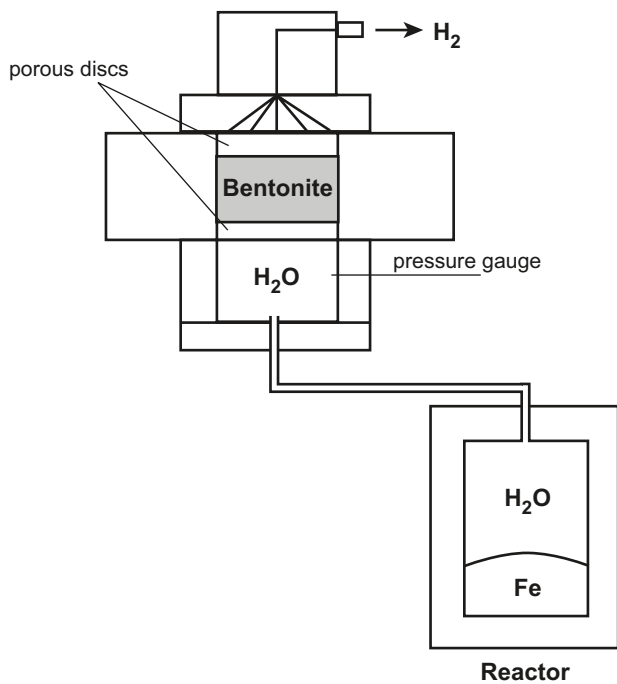

Figure 7-41. Experimental equipment operated in Nuclear Research Institute.

8 Literature

8.1 References

- Albrecht-Gary A M, Blanc S, Rochel N, Ocakatan A Z, Abdallah M A, 1994.** Bacterial ron transport: coordination properties of pyoverdine PaA, a peptidic siderophore of *Pseudomonas aeruginosa*. *Inorganic Chemistry* 33, 6391–6402.
- Anderson C R, Pedersen K, 2003.** In situ growth of Gallionella biofilms and partitioning of lanthanids and actinides between biological material and ferric oxyhydroxides. *Geobiology* 1, p 169–178.
- Anderson C, Jakobsson A-M, Pedersen K, 2006a, “Influence of in situ biofilm coverage on the radionuclide adsorption capacity of subsurface granite”, *Environmental Science and Technology*, vol. 41, no. 3, pp 830–836.**
- Anderson C, Jakobsson A-M, Pedersen K, 2006b.** Autoradiographic comparisons of radionuclide adsorption between subsurface anaerobic biofilms and granitic host rocks. *Geomicrobiology Journal* 23, p 15–29.
- Anderson C R, James R E, Fru E C, Kennedy C B, Pedersen K, 2006c.** In situ ecological development of a bacteriogenic iron oxide-producing microbial community from a subsurface granitic rock environment, *Geobiology*, vol. 4, pp 29–42.
- Anderson J C, 2007.** Äspö pillar stability experiment, final report. Rock mass response to coupled mechanical thermal loading. SKB TR-07-01, Svensk Kärnbränslehantering AB.
- Andersson P, Byegård J, Billaux D, Cvetkovic V, Dershowitz W, Doe T, Hermanson J, Poteri A, Tullborg E-L, Winberg A (ed) 2007.** True Block Scale Continuation Project, Final report. SKB TR-06-42, Svensk Kärnbränslehantering AB.
- Autio J, Johansson E, Hagros A, Anttila P, Rönnqvist P-E, Börgesson L, Sandén T, Eriksson M, Halvarsson B, Berghäll J, Kotola R, Parkkinen I, 2008.** KBS-3H Design Description 2007. SKB R-08-44, Svensk Kärnbränslehantering AB.
- Banwart S, Gustafsson E, Laaksoharju M, Nilsson A-C, Tullborg E-L, Wallin B, 1994.** Large-scale intrusion of shallow water into a granite aquifer, *water resources research*, 30, p 1747–1763.
- Barcena I, Garcai-Sineriz J-L, 2001.** Prototype repository. System for canisters displacement tracking. SKB IPR-02-06, Svensk Kärnbränslehantering AB.
- Bath A, Milodowsk A, Ruotsalainen P, Tullborg E-L, Cortés Ruiz A, Aranyossy J-F, 2000.** Evidence from mineralogy and geochemistry for the evolution of groundwater systems during the quaternary for use in radioactive waste repository assessment (EQUIP Project). Final report, contract no FI4W-CT96-0031. Euratom/EC-DG-Research, Report EUR 19613EN. 157 pp. European Commission, Luxembourg.
- Black J H, Hodgkinson D P, 2005.** Äspö task force on modelling of groundwater flow and transport of solutes: review of task 6C. SKB R-05-33, Svensk Kärnbränslehantering AB.
- Bono N, Röshoff K, 2003.** Prototype repository. Instrumentation for stress, strain and displacement measurements in rock. SKB IPR-03-19, Svensk Kärnbränslehantering AB.
- Bradbury M H, Green A, 1986.** Investigations into the factors influencing long 12 range matrix diffusion rates and pore space accessibility at depth in granite. *Journal of Hydrology* 13, 89, 123–139.
- Bäckblom G, Olsson O, 1994.** Programme for tracer retention understanding experiments. SKB IPR 25-94-24, Svensk Kärnbränslehantering AB.
- Börgesson L, Sandén T, 2002.** Prototype repository. Instrumentation of buffer and backfill in section II. SKB IPR-03-21, Svensk Kärnbränslehantering AB.
- Cheng H, Cvetkovic V, 2009.** Evaluation of colloid transport experiments in a quarried block. *Materials Research Society Symposium Proc.* Vol. 1124 © 2009 Materials Research Society.

- Choppin G R, Thakur P, Mathur J N, 2006.** Complexation thermodynamics and structural aspects of actinide-aminopolycarboxylates. *Coordination Chemistry Reviews* 250, 936947.
- Collin M, Börgesson L, 2002.** Prototype repository. Instrumentation of buffer and backfill for measuring THM processes. SKB IPR-02-09, Svensk Kärnbränslehantering AB.
- Corey A. 1954.** The interrelation between gas and oil relative permeabilities. *Producers Monthly*, Vol. 19: 38–41.
- Cvetkovic V, Cheng H, 2008.** Sorbing tracer experiments in a crystalline rock fracture at Äspö (Sweden): 3. Effect of microscale heterogeneity, *Water Resources Research*, 44, W12447, doi:10.1029/2007WR006797.
- Cvetkovic V, submitted.** Significance of a porosity trend in the rim zone for tracer transport in crystalline rock fractures. Submitted to WRR, January 2009.
- Cvetkovic V, Frampton A, submitted.** Transport and retention from single to multiple fractures in crystalline rock at Äspö (Sweden) – 2. Fracture network flow simulations and global retention properties. Submitted to WRR, March 2009.
- Cvetkovic V, Cheng H, Byegård J, Winberg A, Widestrand H, Andersson P, submitted.** Transport and retention from single to multiple fractures in crystalline rock at Äspö (Sweden) – 1. Evaluation of tracer test results and sensitivity analysis. Submitted to WRR, February 2009.
- Degueldre C, Raabe J, Wold S, 2009.** Investigations of clay colloid aggregates by scanning transmission X-ray microspectroscopy of suspensions. *Applied geochemistry*. In press, corrected proof, available online 6 August 2009.
- Dideriksen K, Christiansen B C, Baker J A, Frandsen C, Balic-Zunic T, Tullborg E, Mørup S, Stipp S L S, 2007.** Fe-oxide fracture fillings as a palaeo-redox indicator: Structure, crystal form and Fe isotope composition. *Chemical Geology* 244, 330–343.
- Dideriksen K, Christiansen B C, Frandsen C, Balic-Zunic T, Mørup S, Stipp S L S, 2009.** Palaeo-redox boundaries in fractured granite. (Final draft report to be published).
- Edelstein N M, Klenze R, Fanghänel Th, Hubert S, 2006.** Optical properties of Cm(III) in crystals and solutions and their application to Cm(III) speciation. *Coordination Chemistry Reviews* 250, 948–973.
- Eriksson S, 2008.** Äspö Hard Rock Laboratory. Prototype Repository. Analysis of microorganisms, gases and water chemistry in buffer and backfill 2004–2007. SKB IPR-08-01, Svensk Kärnbränslehantering AB.
- Essén S A, Johnsson A, Bylund D, Pedersen K, Lundström U S, 2007.** Siderophore production by *Pseudomonas stutzeri* under aerobic and anaerobic conditions, *Applied and Environmental Microbiology*, vol. 73, no. 18, pp. 5857–5864.
- Fatt I, Klikoff W A, 1959.** Effect of fractional wettability on multiphase flow through porous media. *American Institute of Mining, Metallurgical, and Petroleum Engineers (AIME) Transactions*, 216–246, USA.
- Ferris F G, Konhauser K O, Lyuvén B, Pedersen K, 1999.** Accumulation of metals by bacteriogenic iron oxides in a subterranean environment. *Geomicrobiology Journal* 16, 181–192.
- Ferris F G, Hallberg R O, Lyvén B, Pedersen K, 2000.** Retention of strontium, cesium, lead and uranium by bacterial iron oxides from a subterranean environment. *Applied Geochemistry* 15, 1035–1042.
- Forsmark T, 2008.** Äspö hard rock laboratory. Prototype repository. Hydraulic tests and deformation measurements during operation phase. Test campaign 9. SKB IPR-08-22, Svensk Kärnbränslehantering AB.
- García-García S, Jonsson M, Wold S, 2006.** Temperature effect on the stability of bentonite colloids in water. *Journal of Colloid and Interface Science* (2006), 298(2), 694–705.
- García-García S, Wold S, Jonsson M, 2007.** Kinetic determination of critical coagulation concentrations for sodium- and calcium-montmorillonite colloids in NaCl and CaCl₂ aqueous solutions. *Journal of Colloid and Interface Science* (2007), 315(2), 512–519.

- García-García S, Degueldre C, Wold S, Frick S, 2009.** Determining pseudo-equilibrium of montmorillonite colloids in generation and sedimentation experiments as a function of ionic strength, cationic form, and elevation. *Journal of Colloid and Interface Science*, Volume 335, Issue 1, 1 July 2009, pp 54–61.
- Goudarzi R, Johannesson L-E, 2008.** Äspö hard rock laboratory. Prototype repository. Sensors data report (period 010917–080601) Report No:19. SKB IPR-08-21, Svensk Kärnbränslehantering AB.
- Goudarzi R, Johannesson L-E, Börgesson L, 2008a.** Backfill and plug test. Sensors data report (Period 990601–070101) Report No:14. SKB IPR-08-02, Svensk Kärnbränslehantering AB.
- Goudarzi R, Åkesson M, Hökmark H, 2008b.** Äspö hard rock laboratory. Temperature buffer test. Sensors data report (period 030326–080101) Report No:11, SKB IPR-08-16.
- Grant M A, 1977.** Permeability reduction factors at Wairakei. Paper 77-HT-52 presented at The American Institute of Chemical Engineers (AIChE) and American Society of Mechanical Engineers (ASME) Heat Transfer Conference. Salt Lake City, Utah, USA.
- Hallbeck L, Pedersen K, 2008.** Characterization of microbial processes in deep aquifers of the Fennoscandian Shield, *Applied Geochemistry*, 23 1796–1819.
- Harrington J F, Horseman S T, 2003.** Gas migration in KBS-3 buffer bentonite: sensitivity of test parameters to experimental boundary conditions, SKB TR-03-02, Svensk Kärnbränslehantering AB.
- Haveman S A, Pedersen K, 2002.** Microbially mediated redox processes in natural analogues for radioactive waste. *Journal of Contaminant Hydrology* 55, 161–174.
- Haycox J, Pettitt W, 2006.** Acoustic emission and ultrasonic monitoring results from deposition hole DA3545G01 in the prototype repository between April 2006 and September 2006. SKB IPR-06-36, Svensk Kärnbränslehantering AB.
- Hodgkinson D P, Black J H, 2005.** Äspö Task Force on Modelling of Groundwater Flow and Transport of Solutes: Review of Tasks 6A, 6B and 6B2. SKB TR-05-14. Svensk Kärnbränslehantering AB.
- Hodgkinson D, 2007.** Äspö task force on modelling of groundwater flow and transport of solutes – review of tasks 6D, 6E, 6F and 6F2, SKB TR-07-03, Svensk Kärnbränslehantering AB.
- Hodgkinson D P, Benabderrahmane H, Elert M, Hautojärvi A, Selroos J-O, Tanaka Y, Uchida M, 2009.** An overview of task 6 of the Äspö task force: modelling groundwater and solute transport: improved understanding of radionuclide transport in fractured rock. *Hydrogeology Journal*, Vol 17, Number 5, July 2009.
- Hultgren P, 2008.** Äspö Hard Rock Laboratory. A comparative study of tunnel mapping results from the Äspö TBM and drill and blast tunnels. SKB P-08-102, Svensk Kärnbränslehantering AB.
- Hökmark H, Ledesma A, Lassabatere T, Fälth B, Börgesson L, Robinet J C, Sellali N, Sémété P, 2007.** Modelling heat and moisture transport in the ANDRA/SKB temperature buffer test. *Physics and Chemistry of the Earth*, 32, p 753–766.
- Jobmann M, 2000.** Modellgrundlagen und Prognose, hydraulische Modellierungen. Deutsche Gesellschaft zum Bau und Betrieb von Endlagern für Abfallstoffe mbH (DBE), pp 10–11, Germany.
- Johnsson A, Arlinger J, Pedersen K, Ödegaard-Jensen A, Albinsson Y, 2006.** Solid-aqueous phase partitioning of radionuclides by complexing compounds excreted by subsurface bacteria. *Geomicrobiology Journal* 23, pp 621–630.
- Kelokaski M, Oila E, Siitari-Kauppi M, 2001.** Investigation of porosity and microfracturing in granitic rock using the ¹⁴C-PMMA technique on samples from the true block scale site at the Äspö hard rock laboratory. Äspö hard rock laboratory IPR-01-27. Svensk Kärnbränslehantering AB.
- Kersting A B, Efured D W, Finnegan D L, Rokop D J, Smith D K, Thompson L J, 1999.** Migration of plutonium in groundwater at the Nevada test site. *Nature*, 297, 7 January, pp 56–59.
- Kristensson O, Hökmark H, 2007.** Thermal 3D modelling of Äspö prototype repository. SKB IPR-07-01, Svensk Kärnbränslehantering AB.

- Laaksoharju M, Degueldre C I, Skårman C, 1995.** Studies of colloids and their importance for repository performance assessment. SKB TR 95-24, Svensk Kärnbränslehantering AB.
- Ledesma A, Jacinto A, Velasco M, 2006.** Temperature buffer test, ENRESA contribution, final report, CIMNE-UPC, DM Iberia.
- Ledesma A, Jacinto A, 2007.** Modelling andra experiment “Temperature buffer test”, final report 2007, CIMNE-UPC.
- Masurat P, Eriksson S, Pedersen K, 2008a.** Evidence of indigenous sulphate-reducing bacteria in commercial Wyoming bentonite MX-80, Applied Clay Science (on-line: doi:101016/jclay200807002).
- Masurat P, Eriksson S, Pedersen K, 2008b.** Microbial sulphide production in compacted Wyoming bentonite MX-80 under in situ conditions relevant to a repository for high-level radioactive waste, Applied Clay Science (available on-line: doi: 101016/jclay200901004).
- Moll H, Glorius, M, Bernhard G, Johnsson A, Pedersen, K, Schäfer M, Budzikiewicz H, 2008a.** Characterization of pyoverdins secreted by a subsurface strain of *Pseudomonas fluorescens* and their interactions with uranium(VI). Geomicrobiology Journal, 25 no. 3, pp 157–166.
- Moll H, Johnsson A, Schäfer M, Pedersen K, Budzikiewicz K, Bernhard G, 2008b.** Curium(III) complexation with pyoverdins secreted by a groundwater strain of *Pseudomonas fluorescens*, Biometals, 21 219–228.
- Mualem Y, 1976.** A new model for predicting the hydraulic conductivity of unsaturated porous media. Water Resources Research, Vol. 12, No. 3: pp 513–522, Washington, DC, USA.
- Nielsen M E, Pedersen K, Fisk M, Istok J, 2006.** Microbial nitrate respiration of lactate at in situ conditions in groundwater from a granitic aquifer situated 450 m underground, Geobiology, vol. 4, pp 43–52.
- Nordqvist R, Byegård J, Hjerne C, 2008.** Feasibility study of a single well injection withdrawal (SWIW) experiment with synthetic groundwater. SKB R-08-125, Svensk Kärnbränslehantering AB.
- Norman K G, Andersson P, 2007.** Prototype repository. Tracer dilution tests during operation phase, test campaign 2. SKB IPR-07-03, Svensk Kärnbränslehantering AB.
- Pedersen K, Albinsson Y, 1991.** Effect of cell number, pH and lanthanide concentration on the sorption of promethium by *Shewanella putrefaciens*, Radiochimica Acta, 54 pp 91–95.
- Pedersen K, Albinsson Y, 1992.** Possible effects of bacteria on trace element migration in crystalline bed-rock, Radiochimica Acta, 58/59 pp 365–369.
- Pedersen K, 2000.** The microbe site. Drilling, instrumentation and characterisation. SKB IPR-00-36, pp 1–25, Svensk Kärnbränslehantering AB.
- Pedersen K, 2001.** Diversity and activity of microorganisms in deep igneous rock aquifers of the Fennoscandian shield. In subsurface microbiology and biogeochemistry. Edited by Fredrickson J K and Fletcher M Wiley-Liss Inc. New York. pp 97–139.
- Pedersen K, 2002.** Microbial processes in the disposal of high level radioactive waste 500 m underground in Fennoscandian shield rocks. In Interactions of microorganisms with radionuclides. Edited by Keith-Roach M J and Livens F R Elsevier, Amsterdam. pp 279–311.
- Pedersen K, 2005.** The MICROBE framework: Site descriptions, instrumentation, and characterization. SKB IPR-05-05, pp 1–85, Svensk Kärnbränslehantering AB.
- Pedersen K, Arlinger J, Hallbeck A, Hallbeck L, Eriksson S, Johansson J, 2008.** Numbers, biomass and cultivable diversity of microbial populations relate to depth and borehole-specific conditions in groundwater from depths of 4 to 450 m in Olkiluoto, Finland, The ISME Journal, 2 pp 760–775.
- Powell P E, Cline G R, Reid C P P, Szaniszló P J, 1980.** Occurrence of hydroxamate siderophore iron chelators in soils. Nature 287, 833–834.
- Pruess K, Oldenburg C, Moridis G, 1999.** Tough2 user’s guide. Lawrence Berkeley National Laboratory, University of California, Berkeley, Version 2.0, p 197, California USA.

- Puigdomenech I, Sandén T, 2001.** Prototype repository. Instrumentation for gas and water sampling in buffer and backfill. Tunnel section I. SKB IPR-01-62, Svensk Kärnbränslehantering AB.
- Pusch R, 2001.** Prototype repository. Selection of THMCB models. SKB IPR-01-66, Svensk Kärnbränslehantering AB.
- Pusch R, Svemar C, 2003.** Prototype repository. Predictive modelling of EBS performance in the Prototype repository project. SKB IPR-03-26, Svensk Kärnbränslehantering AB.
- Rhén I, Forsmark T, Magnusson, Alm P, 2003.** Prototype repository. Hydrogeological, hydrochemical and temperature measurements in boreholes during the operation phase of the prototype repository tunnel section II. SKB IPR-03-22, Svensk Kärnbränslehantering AB.
- Rodwell W R, Harris A W, Horseman S T, Lalieux P, Müller W, Amaya L O, Pruess K, 1999.** Gas migration and two phase flow through engineered and geological barriers for a deep repository for radioactive waste. European Commission, EUR 19122 EN, pp 63–73, 101–114, Belgium.
- Rothfuchs T, Hartwig L, Komischke M, Mieke R, Wiczorek K, 2003.** Prototype repository. Instrumentation for resistivity measurements in buffer backfill and rock in section II. SKB IPR-03-48, Svensk Kärnbränslehantering AB.
- Schaap M G, Van Genuchten M Th. 2005.** A modified Mualem-Van Genuchten formulation for improved description of the hydraulic conductivity near saturation. *Vadose Zone Journal* 5:27–34 2006, pp 27–29, Madison USA.
- Skagius K, Neretnieks I, 1986.** Porosities and diffusivities of some nonsorbing 21 species in crystalline rocks. *Water Resources Research*, 22(3), pp 389–398.
- SKB, 2001.** Forsknings-, utvecklings- och demonstrationsprogram för ett KBS-3-förvar med horisontell deponering. SKB R-01-55, Svensk Kärnbränslehantering AB.
- SKB, 2007.** RD&D-Programme 2007. Programme for research, development and demonstration of methods for the management and disposal of nuclear waste. SKB TR-07-12, Svensk Kärnbränslehantering AB.
- SKB, 2008a.** Äspö hard rock laboratory. Planning report for 2007. SKB IPR-08-03 Svensk Kärnbränslehantering AB.
- SKB, 2008b.** Äspö hard rock laboratory. Status report January–March 2008. SKB IPR-08-14, Svensk Kärnbränslehantering AB.
- SKB, 2008c.** Äspö hard rock laboratory. Status report April–June 2008. SKB IPR-08-20, Svensk Kärnbränslehantering AB.
- SKB 2008d.** Horizontal deposition of canisters for spent nuclear fuel. Summary of the KBS-3H project 2004-2007. SKB TR-08-03, Svensk Kärnbränslehantering AB.
- SKB, 2009a.** Äspö hard rock laboratory. Status report July – September 2008. SKB IPR-09-02, Svensk Kärnbränslehantering AB.
- SKB, 2009b.** Äspö hard rock laboratory. Status report October–December 2008. SKB IPR-09-06, Svensk Kärnbränslehantering AB.
- Smellie J A T, Waberg H N, Frøpe S K, 2003.** Matrix fluid chemistry experiment. Final report. June 1998–March 2003. SKB R-03-18, Svensk Kärnbränslehantering AB.
- Smith P, Neall F, Snellman M, Pastina B, Hjerpe T, Nordman H, Johnson L, 2008.** Safety assessment for a KBS-3H spent nuclear fuel repository at Olkiluoto. Summary report. SKB R-08-39, Svensk Kärnbränslehantering AB.
- Uchida M, Dershowitz W, Lee G, Shuttle D, 2009.** An empirical probabilistic approach for constraining the uncertainty of long-term solute transport predictions in fractured rock using in situ tracer experiments. *Hydrogeology Journal*, Vol 17, Number 5, July 2009.
- Van Genuchten M Th, 1980.** A closed-form equation for predicting the hydraulic conductivity of unsaturated soils, *Soil Sci. Soc. Vol. 44*, pp 892–898.

Vilks P, Miller N H, Stanchell F W, 2005. Laboratory program supporting SKB's long term diffusion experiment. Report no: 06819-REP-01300-10111-R00. Nuclear Waste Management. Ontario Power Generation, Canada.

Vilks P, Miller N H, 2006. Laboratory bentonite colloid migration experiments to support the Äspö colloid project. Supporting technical report. 06819-REP-01300-10123-R00. Ontario Power Generation, Canada.

Zhang C L, Rothfuchs T, Jockwer N, Wieczorek K, Dittrich J, Müller J, Hartwig L, Komischke M, 2007. Thermal effects on the opalinus clay. A joint heating experiment of ANDRA and GRS at the Mont Terri URL (HE-D project). Final report GRS – 224. Gesellschaft für Anlagensicherheit (GRS), pp 64–67, Germany.

Zolezzi F, Haycox J, Pettitt W, 2007. Acoustic emission and ultrasonic monitoring results from deposition hole DA3545G01 in the prototype repository between October 2006 and March 2007. SKB IPR-07-12, Svensk Kärnbränslehantering AB.

Åkesson M, 2006a. Temperature buffer test. Evaluation modelling – field test. SKB IPR-06-10, Svensk Kärnbränslehantering AB.

Åkesson M, 2006b. Temperature buffer test. Evaluation modelling – mock-up test. SKB IPR-06-11, Svensk Kärnbränslehantering AB.

Åkesson M, 2008. Temperature buffer test. Evaluation modeling – TBT_3 mock-up test. SKB IPR-08-09, Svensk Kärnbränslehantering AB.

8.2 List of papers and articles published 2008

Microbe project

Hallbeck L, Pedersen K, 2008. Characterization of microbial processes in deep aquifers of the Fennoscandian shield. *Applied Geochemistry* 23: pp 1796–1819.

Kyle JE, Eydal HSC, Ferris FG, Pedersen K, 2008. Viruses in granitic groundwater from 69 to 450 m depth of the Äspö hard rock laboratory, Sweden. *The ISME Journal* 2:571-4.

Masurat P, Eriksson S, Pedersen K, 2008. Evidence of indigenous sulphate-reducing bacteria in commercial Wyoming bentonite MX-80. *Applied Clay Science* (on-line: doi:10.1016/j.clay.2008.07.002).

Masurat P, Eriksson S, Pedersen K, 2009. Microbial sulphide production in compacted Wyoming bentonite MX-80 under in situ conditions relevant to a repository for high-level radioactive waste. *Applied Clay Science* (on-line: doi:10.1016/j.clay.2009.01.004).

Moll H, Glorius M, Bernhard G, Johnsson A, Pedersen K, Schäfer M et al. 2008. Characterization of pyoverdins secreted by a subsurface strain of *Pseudomonas fluorescens* and their interactions with uranium(VI). *Geomicrobiology Journal* 25 (3): pp 157–166.

Moll H, Johnsson A, Schäfer M, Pedersen K, Budzikiewicz K, Bernhard G, 2008. Curium(III) complexation with pyoverdins secreted by a groundwater strain of *Pseudomonas fluorescens* *Biometals* 21: pp 219–228.

Fe-oxides in Fractures

Dideriksen K, Christiansen B C, Baker J A, Frandsen C, Balic-Zunic T, Tullborg E, Mørup S, Stipp S L S, 2007. Fe-oxide fracture fillings as a palaeo-redox indicator: structure, crystal form and Fe isotope composition. *Chemical Geology* 244, pp 330–343.

Dideriksen K, Christiansen B C, Frandsen C, Balic-Zunic T, Mørup S, Stipp S L S. Palaeo-redox boundaries in fractured granite. To be submitted to *Geochimica et Cosmochimica Acta*.

8.3 Documents published 2008

During 2008 the following reports and documents have been published in the SKB series.

International Progress Reports

Dershowitz W, Fox A, Lee G, Van Fossen M, Uchida M, 2006. Äspö task force on modelling of groundwater flow and transport solutes. Discrete fracture network flow and transport modelling at the rock block scale: task 6D, 6E, 6F and 6F2. SKB IPR-06-22, Svensk Kärnbränslehantering AB.

Äspö Hard Rock Laboratory. Planning report for 2007. SKB IPR-07-06, Svensk Kärnbränslehantering AB.

Nowak, T, Köster H, Flentje R, Sanchez-Herrero S, Lege C, 2007. Lasgit Large Scale Gas Injection Test. Hydraulic test with surface packer systems. SKB IPR-07-14, Svensk Kärnbränslehantering AB.

Eng A, Nilsson U, Svensson D, 2007. Alternative Buffer Material. Installation report. SKB IPR-07-15, Svensk Kärnbränslehantering AB.

Johannesson L-E, 2007. Canister Retrieval Test. Dismantling and sampling of the buffer and determination of density and water ratio. SKB IPR-07-16, Svensk Kärnbränslehantering AB.

Forsmark T, 2007. Prototype Repository. Hydraulic tests and deformation measurements during operation phase. Test campaign 8. Single hole tests. SKB IPR-07-17, Svensk Kärnbränslehantering AB.

Sjöberg J, Berglund B, Mas Ivars D, 2007. Core dinking study in the TASQ (APSE) tunnel, Äspö HRL. SKB IPR-07-18, Svensk Kärnbränslehantering AB.

Goudarzi R, Åkesson M, Hökmark H, 2007. Temperature Buffer Test. Sensors data report (Period: 030326–070701) Report No:10. SKB IPR-07-21, Svensk Kärnbränslehantering AB.

Eriksson S, 2007. Prototype Repository. Analysis of microorganisms, gases and water chemistry in buffer and backfill 2004–2007. SKB IPR-08-01, Svensk Kärnbränslehantering AB.

Goudarzi R, Johannesson L-E, Börgesson L, 2007. Backfill and Plug test. Sensors data report (Period 990601–070101) Report No:14. SKB IPR-08-02, Svensk Kärnbränslehantering AB.

Nirvin B, 2007. Retrieval of deposited canister for spent nuclear fuel. Freeing – slurring of saturated bentonite buffer around a canister in Äspö HRL. Technology, equipment and results in connection with freeing for the Canister Retrieval Test. SKB IPR-08-04, Svensk Kärnbränslehantering AB.

Bäckström A, 2008. DECOVALEX. Validation of the ultrasonic borehole investigation in the TASQ tunnel. SKB IPR-08-05, Svensk Kärnbränslehantering AB.

Luukkonen A, 2008. Prototype Repository. Inverse modelling of a Prototype Repository using near-field groundwater samples from July 1998–March 2004. SKB IPR-08-06, Svensk Kärnbränslehantering AB.

SKB, 2008. Äspö Hard Rock Laboratory. Status Report. October–December 2007. SKB IPR-08-07, Svensk Kärnbränslehantering AB.

Lönnqvist M, Kristensson O, Hökmark H, 2008. CAPS – Confining Application to Prevent Spalling. Scoping calculations – Field test at Äspö HRL. SKB IPR-08-08, Svensk Kärnbränslehantering AB.

Åkesson M, 2008. Temperature Buffer Test. Evaluation modelling TBT_3 Mock-up test. SKB IPR-08-09, Svensk Kärnbränslehantering AB.

Börgesson L, Hernelind J, Ludvigsson, J-E, 2004. DECOVALEX III, Task 1. Modelling of FEBEX in situ test. Coupled thermo-hydro-mechanical analysis of the buffer and the rock. SKB IPR-08-12, Svensk Kärnbränslehantering AB.

Eng A, 2008. Canister Retrieval Test. Retrieval phase. Project report. SKB IPR-08-13, Svensk Kärnbränslehantering AB.

SKB, 2008. Äspö Hard Rock Laboratory. Status Report. January–March 2008. SKB IPR-08-14, Svensk Kärnbränslehantering AB.

Goudarzi R, Åkesson M, Hökmark H, 2008. Temperature Buffer Test. Sensors data report (Period: 030326–080101) Report No:11. SKB IPR-08-16, Svensk Kärnbränslehantering AB.

Wass E, Nyberg, G, 2007. Hydro Monitoring Program. Report for 2007. SKB IPR-08-19, Svensk Kärnbränslehantering AB.

Äspö Hard Rock Laboratory. Status Report. April – June 2008. SKB IPR-08-20, Svensk Kärnbränslehantering AB.

Goudarzi R, Johannesson L-E, 2008. Prototype Repository. Sensors data report (Period: 010917–080601). Report No:19. SKB IPR-08-21, Svensk Kärnbränslehantering AB.

Technical documents

Four technical documents have been published during 2008.

International technical documents

One international technical document has been published during 2008.

