

Appendix 7

Backfill in section 2

**Total pressure\ Backfill \ Section 2 (030508-081201)
Geokon**

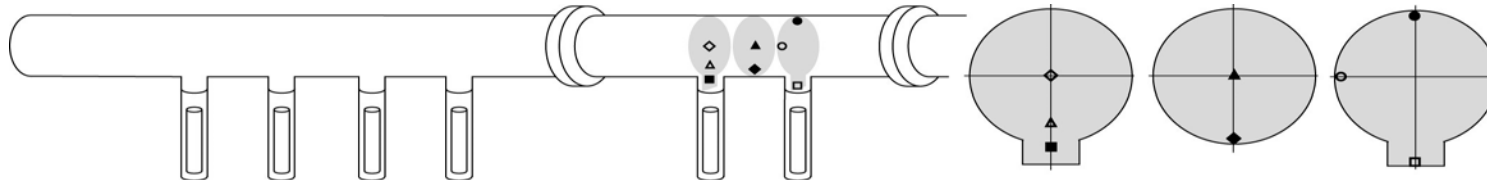
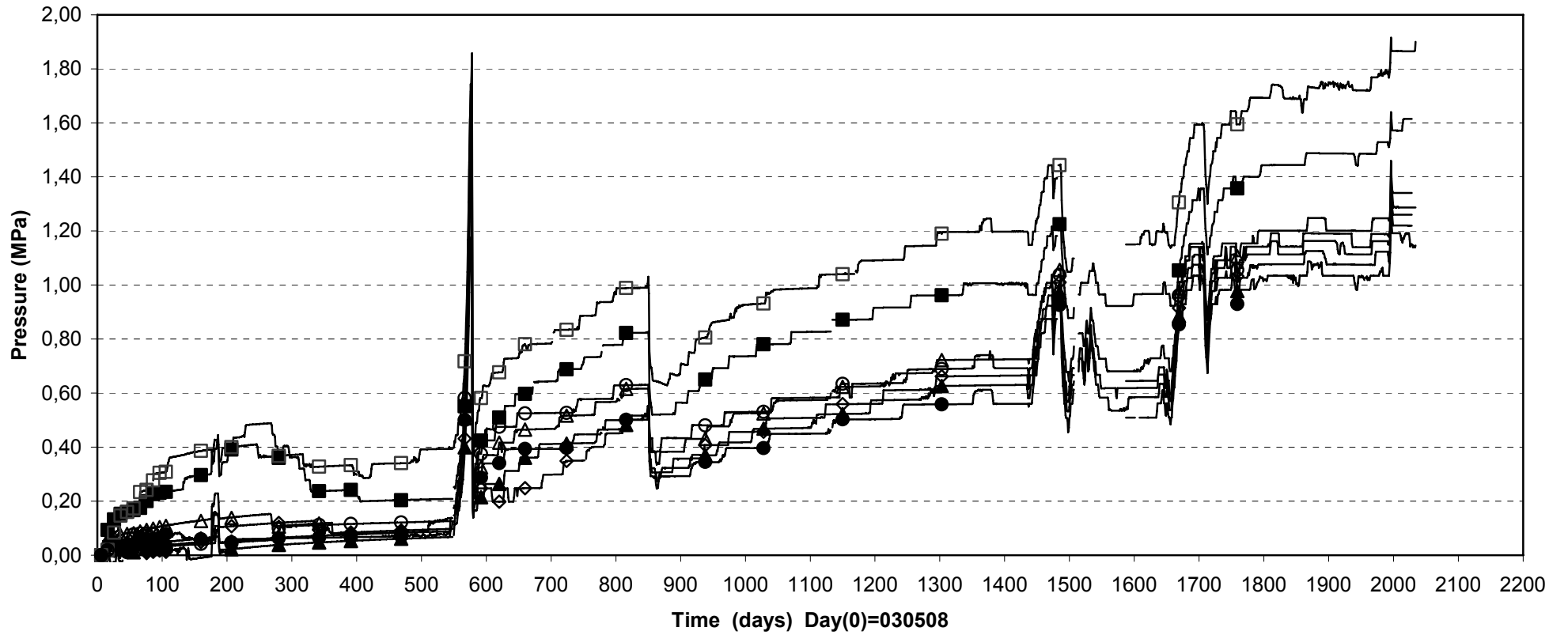

◇ PFA02 (E5\0\0\3551)	△ PFA03 (E5\0\ -1.75\3551)	■ PFA04 (E5\0\ -2.6\3551)
▲ PFA08 (F5-6\0\0\3548)	◆ PFA09 (F5-6\0\ -2.3\3548)	□ PFA13 (E6\0\ -3.15\3545)
○ PFA14 (E6\ -2.3\0\3545)	● PFA15 (E6\0\2.3\3545)	

Prototype\ Backfill \ Section 2 (030508-081201)
 Total pressure - Kulite

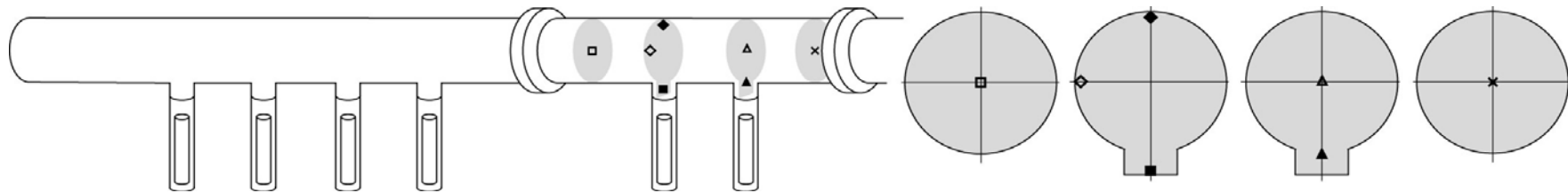
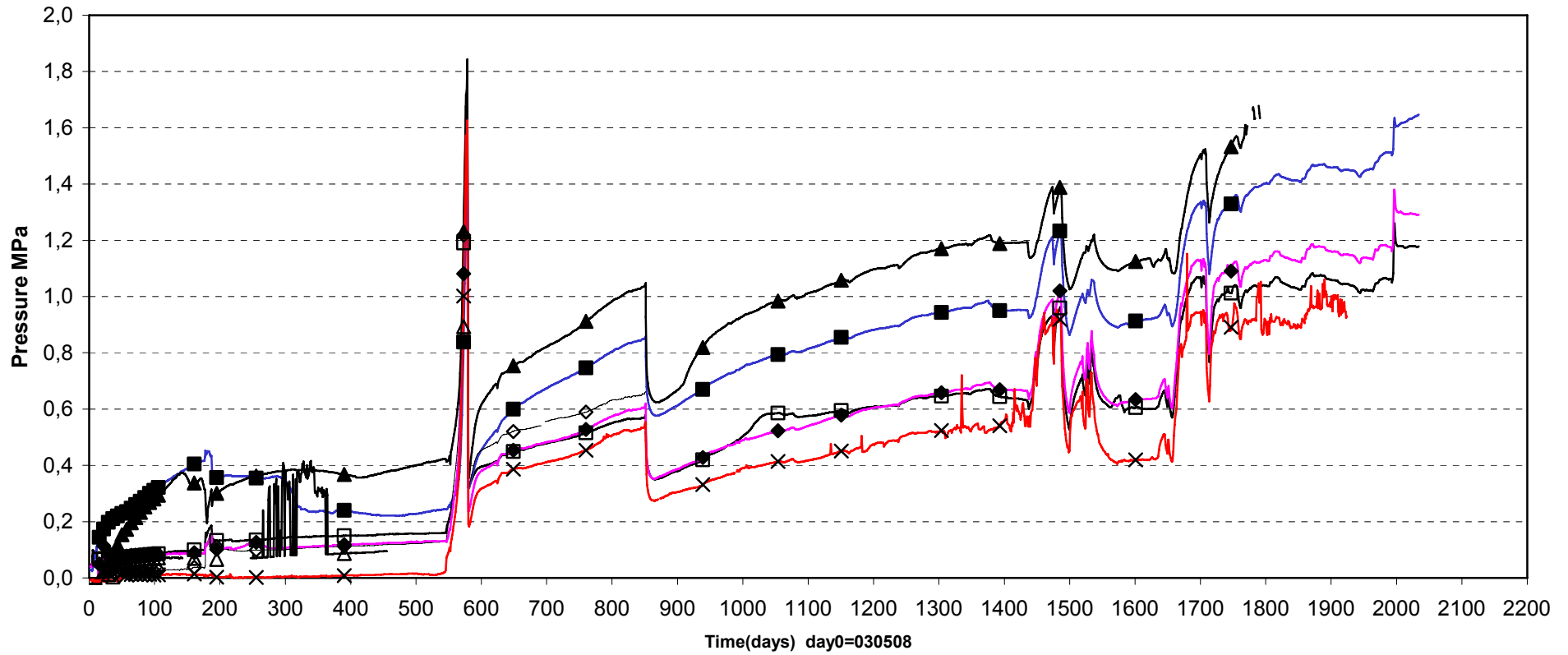

□ PFA01 (Inner part\0\0\3556)	■ PFA05 (E5\0\ -3.15\3551)	◇ PFA06 (E5\ -2.3\0\3551)	◆ PFA07 (E5\0\2.3\3551)
△ PFA10 (E6\0\0\3545)	▲ PFA12 (E6\0\ -2.6\3545)	× PFA16 (In front of plug\0\0\3539)	

Prototype\Backfill \Section2\ Inner part (030508-081201)
 Suction - Wescor

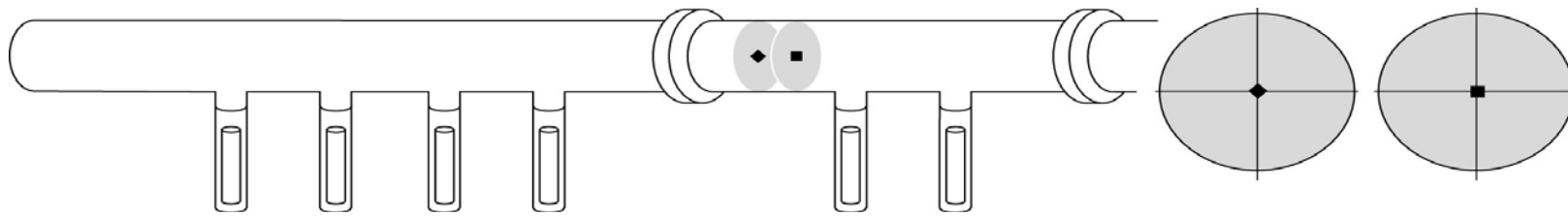
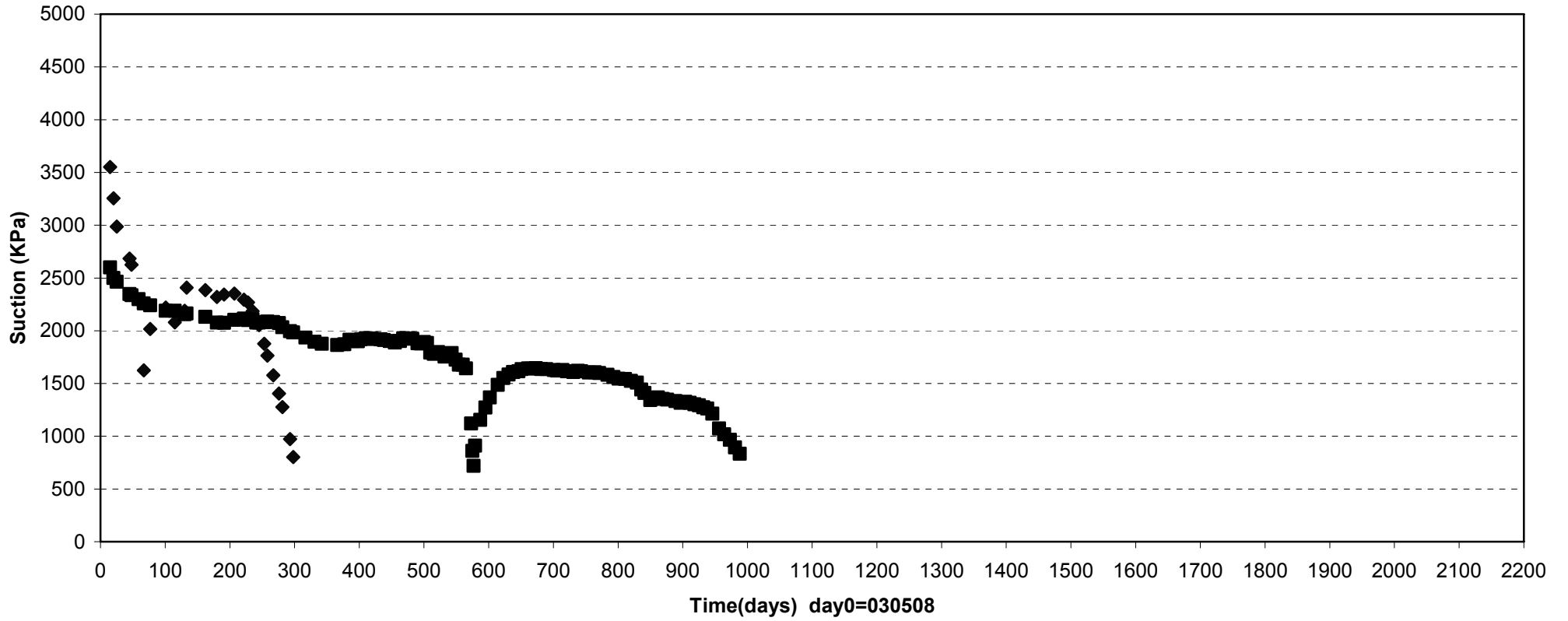

◆ WFA01(Inner part\0\0\3556) ■ WFA02(Inner part\0\0\3554)

Prototype\Backfill\ Above dep.hole 5 (030508-081201)
 Suction - Wescor

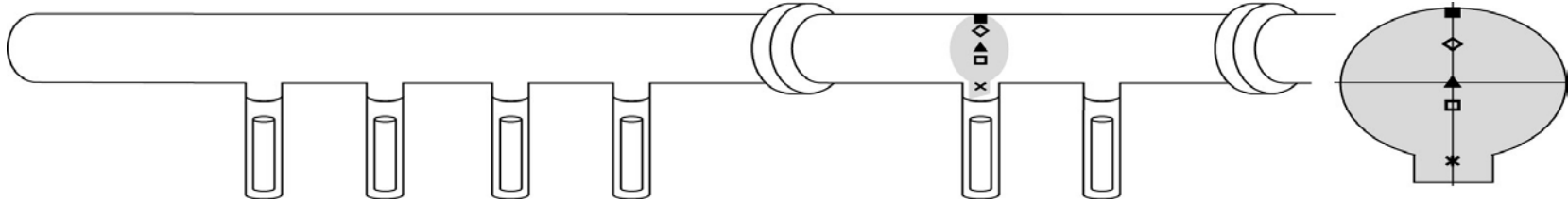
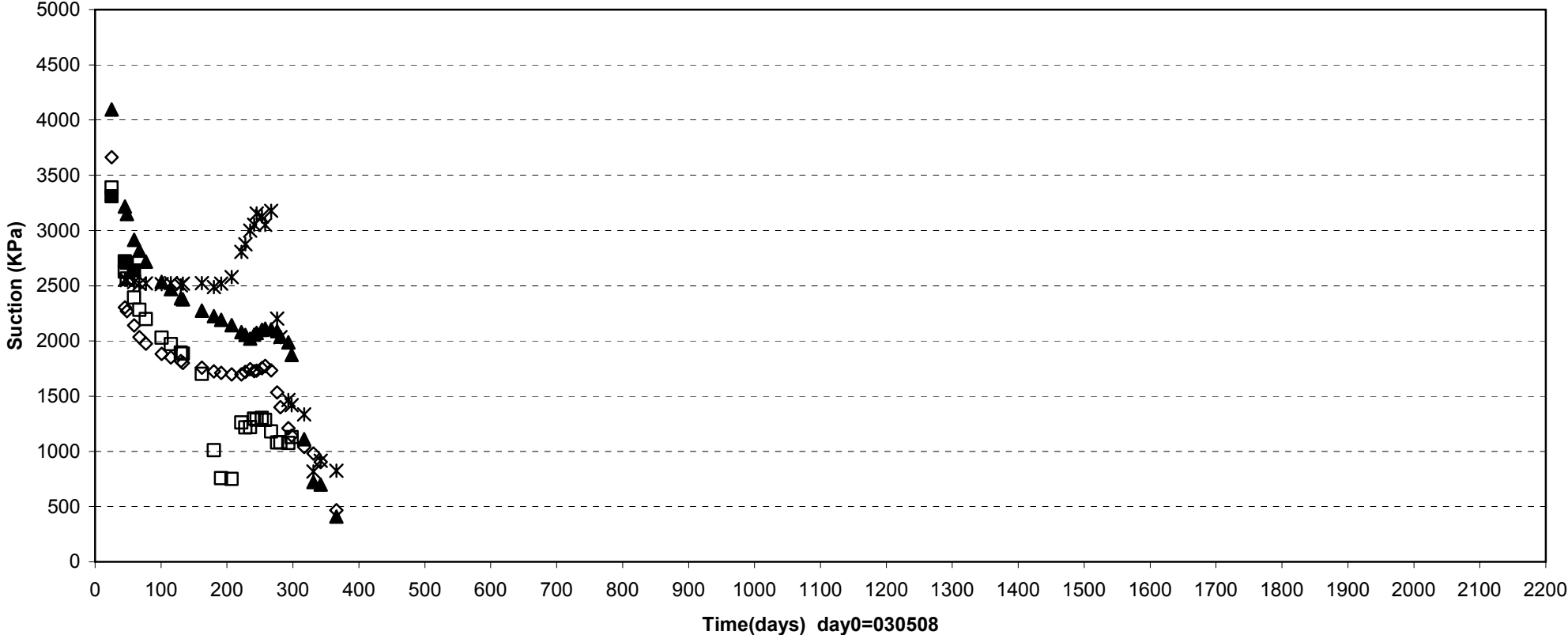

WFA03(E5\0\2.3\3551)
 WFA04(E5\0\1.25\3551)
 WFA05(E5\0\0\3551)
 WFA06(E5\0\0.8\3551)
 WFA08(E5\0\2.6\3551)

**Prototype\Backfill\ Above dep.hole 5 (030508-081201)
Suction - Wescor**

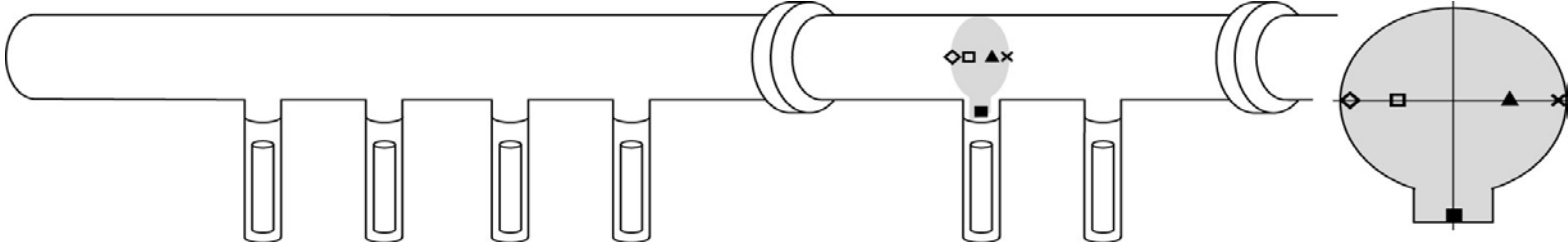
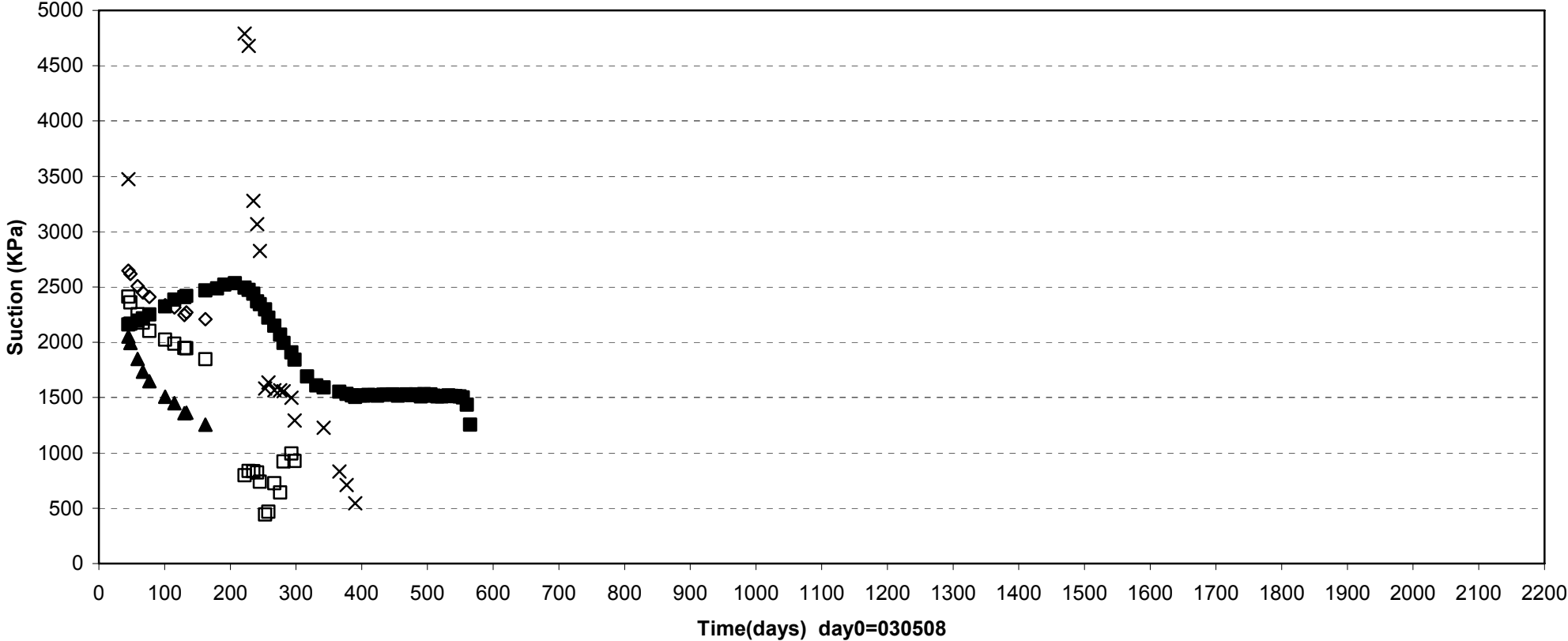

WFA09(E5\0\ -3.15\3551)
 WFA10(E5\ -2.3\0\3551)
 WFA11(E5\ -1.25\0\3551)
 WFA12(E5\1.25\0\3551)
 WFA13(E5\2.3\0\3551)

Prototype\Backfill \ Between dep.hole 5 and hole 6 (030508-081201)
 Suction - Wescor

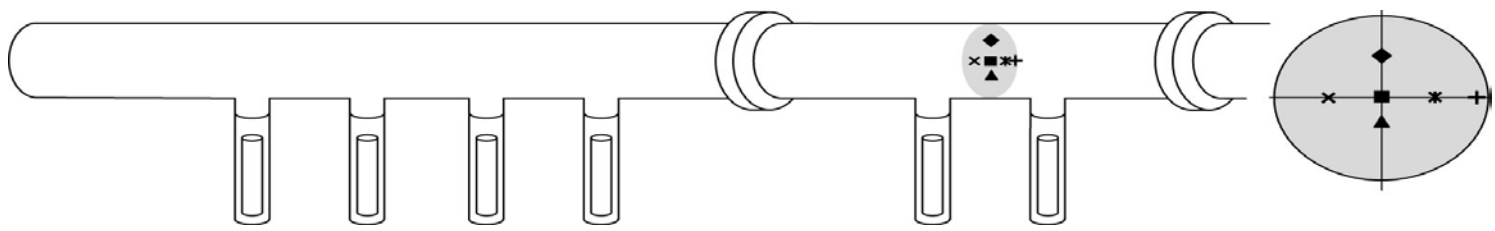
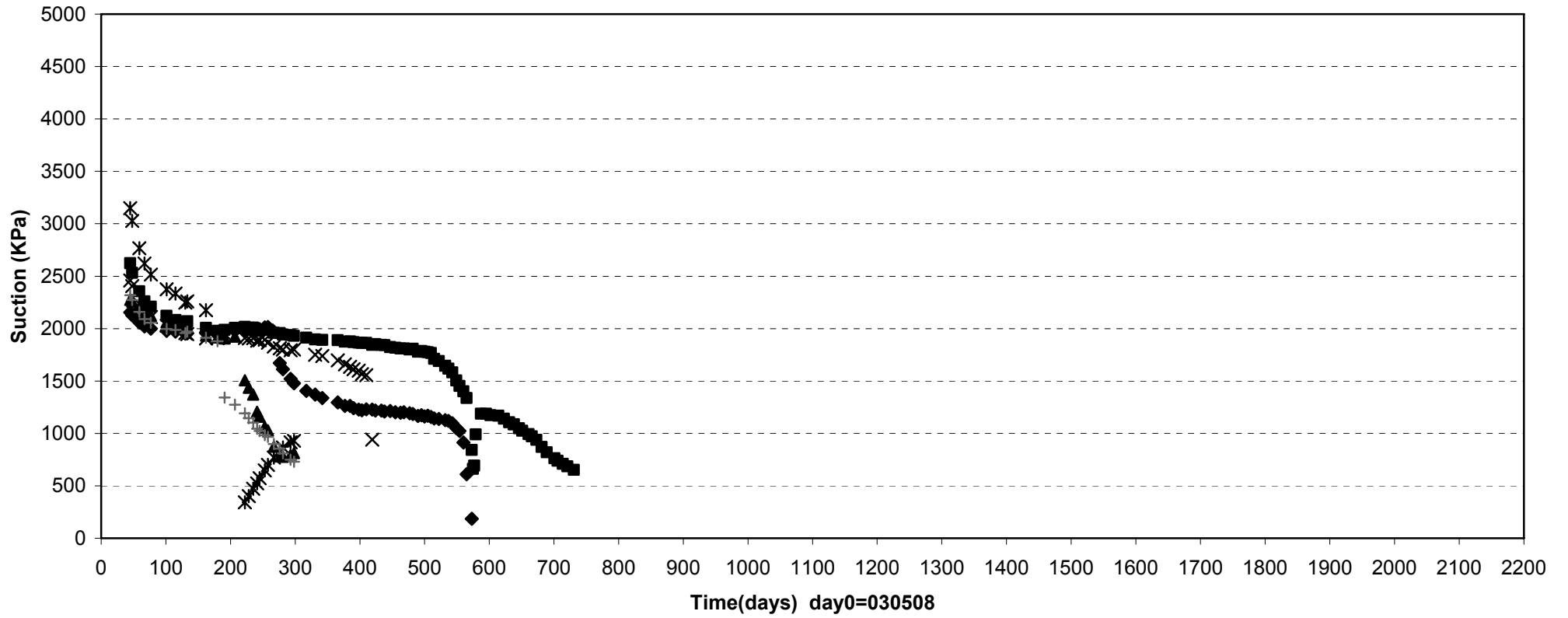

- ◆ WFA15(F5-6\0\1.25\3548) ■ WFA16(F5-6\0\0\3548) ▲ WFA17(F5-6\0\0.8\3548) × WFA18(F5-6\1.25\0\3548)
- ✱ WFA19(F5-6\1.25\0\3548) + WFA30(E5-6\0\2.3\3548)

Prototype\Backfill \Section2\ Above dep.hole 6 (030508-081201)
 Suction - Wescor

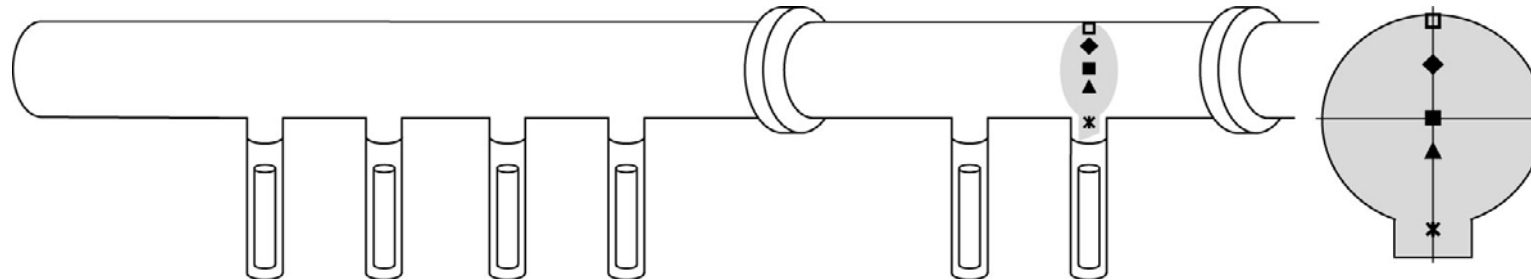
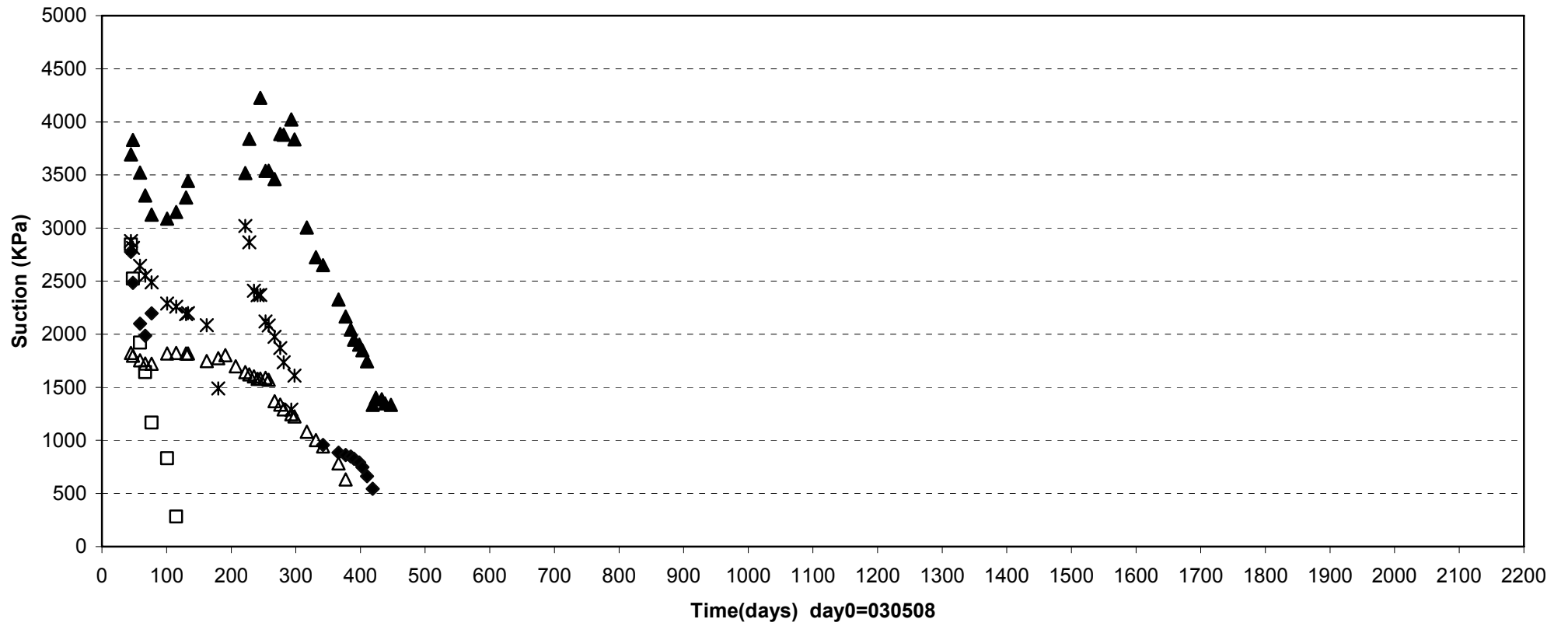

□ WFA20(E6\0\2.3\3545) ◆ WFA21(E6\0\1.25\3545) ■ WFA22(E6\0\0\3545) ▲ WFA23(E6\0\0.8\3545) ✱ WFA25(E6\0\2.6\3545) △ WFA24(E6\0\1.75\3545)

Prototype\Backfill\Section2\ Above dep.hole 6 (030508-081201)
 Suction - Wescor

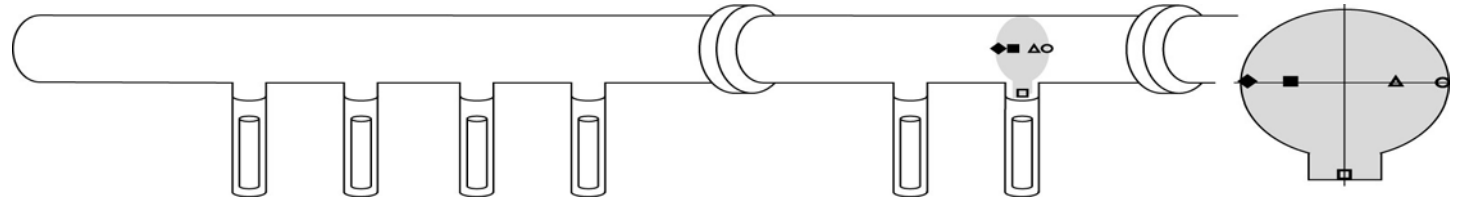
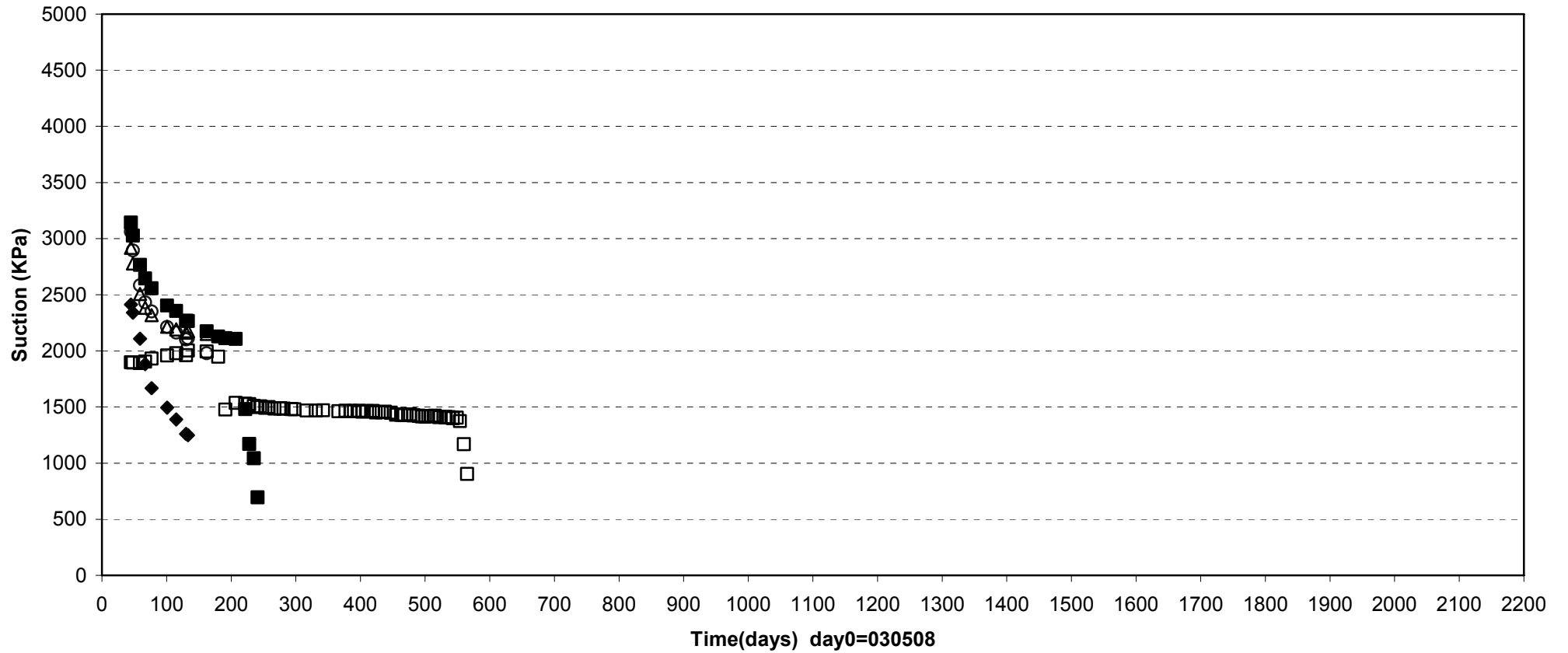

○ WFA07(E6\2.3\0\3545) □ WFA26(E6\0\3.15\3545) ◆ WFA27(E6\2.3\0\3545) ■ WFA28(E6\1.25\0\3545) △ WFA29(E6\1.25\0\3545)

Prototype\Backfill \Section2 \ In front of plug (030508-081201)
 Suction - Wescor

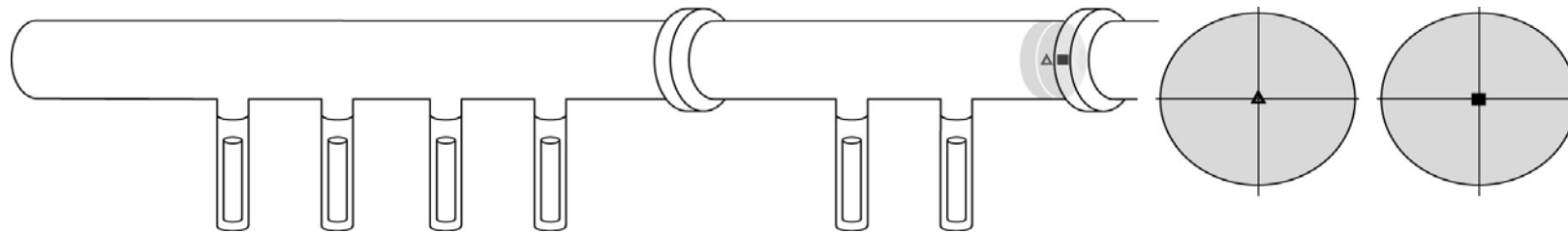
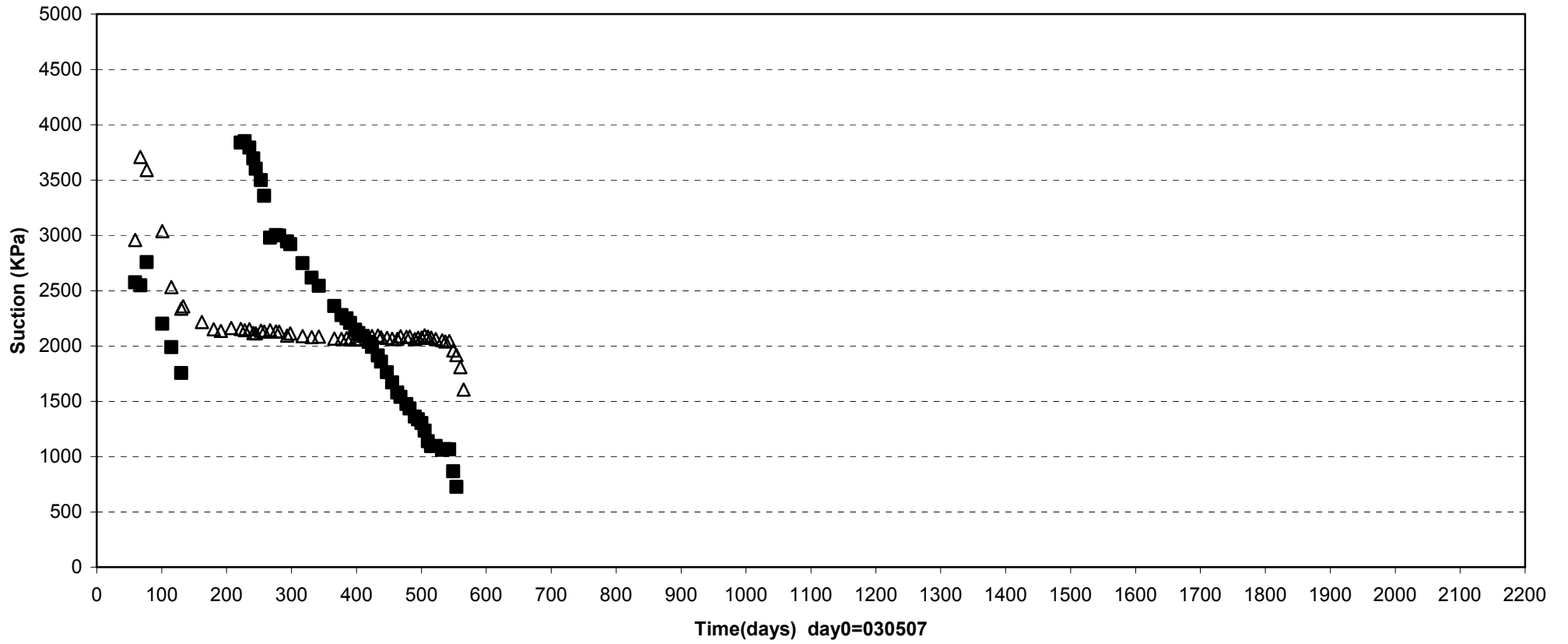

△ WFA31(In front of plug\0\0\3540) ■ WFA32(In front of plug\0\0\3539)

Prototype\Backfill \Over hole 5 (030508-081201)
Pore pressure - Geokon

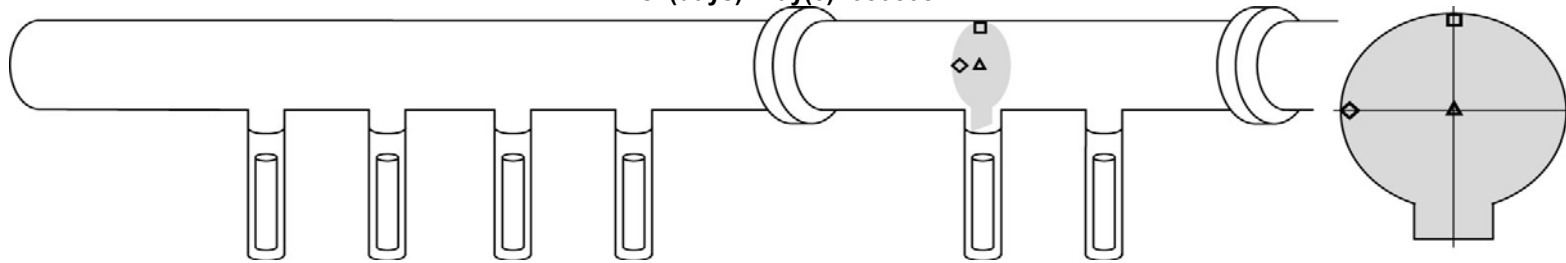
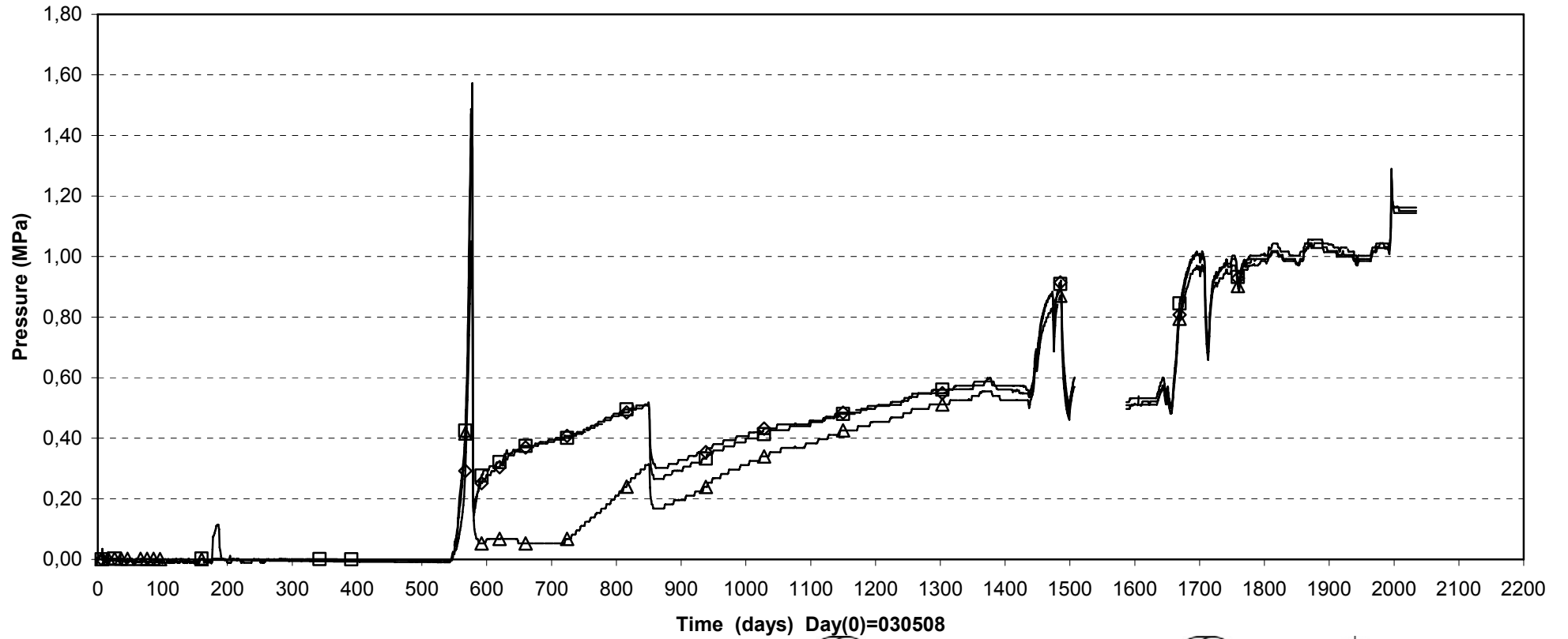

△ UFA03 (E5\0\0\3551)
◇ UFA07 (E5\0\1.75\3551)
□ UFA08 (E5\0\2.3\3551)

Prototype \Backfill \ Over hole 6 (030508-081201)
Pore pressure - Geokon

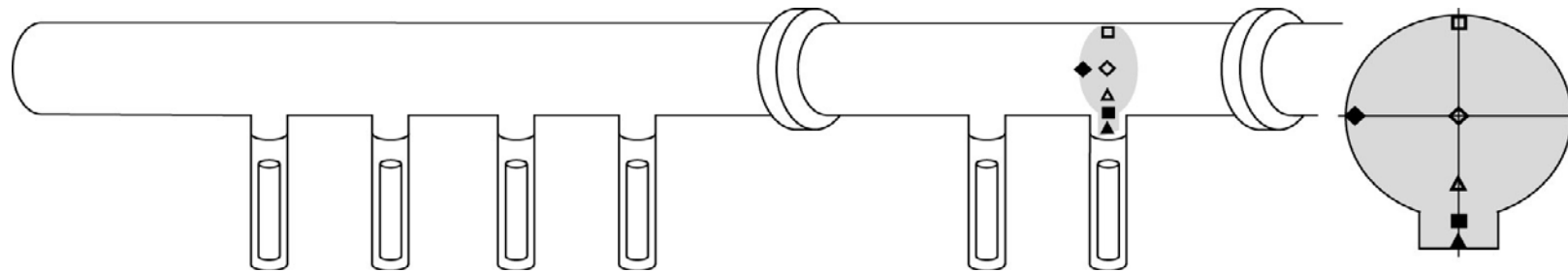
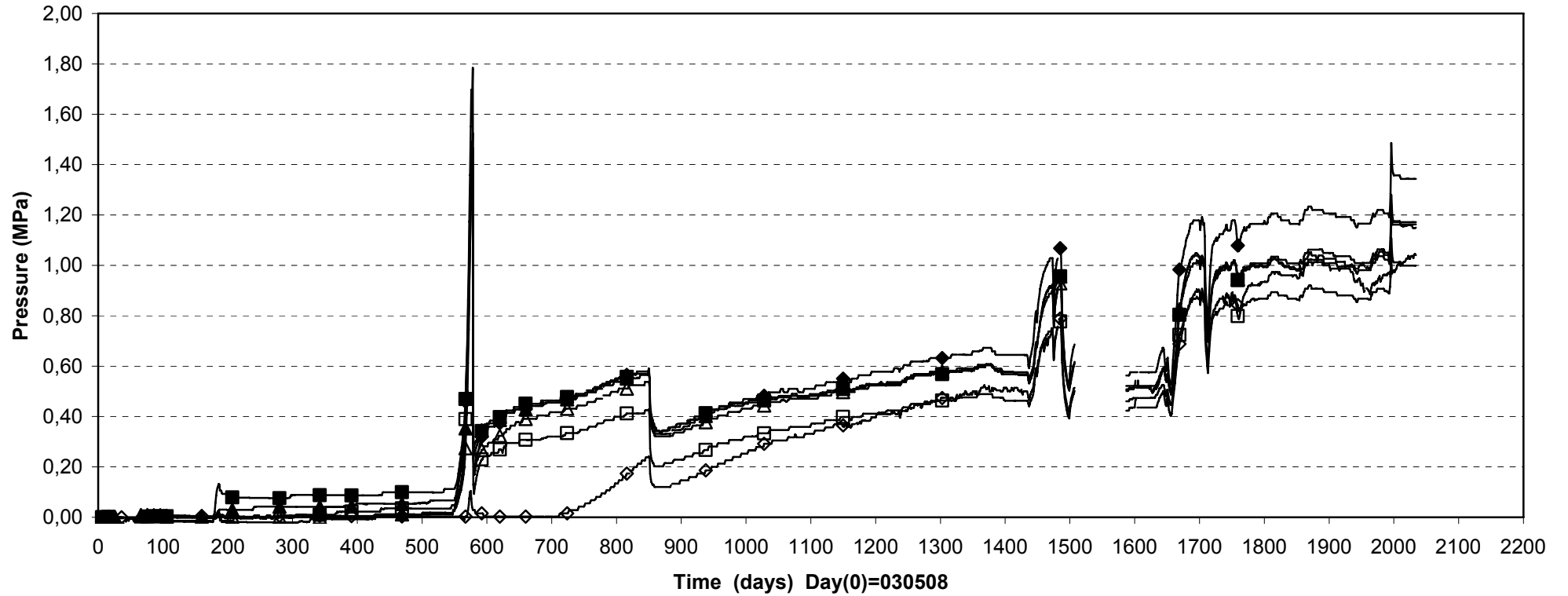

- | | | |
|----------------------------|----------------------------|---------------------------|
| ◇ UFA11 (E6\0\0\3545) | △ UFA12 (E6\0\ -1.75\3545) | ■ UFA13 (E6\0\ -2.6\3545) |
| ▲ UFA14 (E6\0\ -3.15\3545) | ◆ UFA15 (E6\ -2.3\0\3545) | □ UFA16 (E6\0\2.3\3545) |

Prototype\Backfill \ Section2 (030508-081201)
 Pore pressure - Geokon

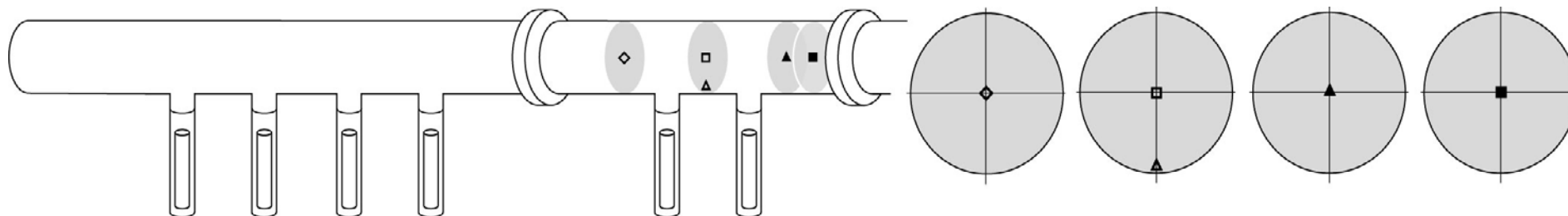
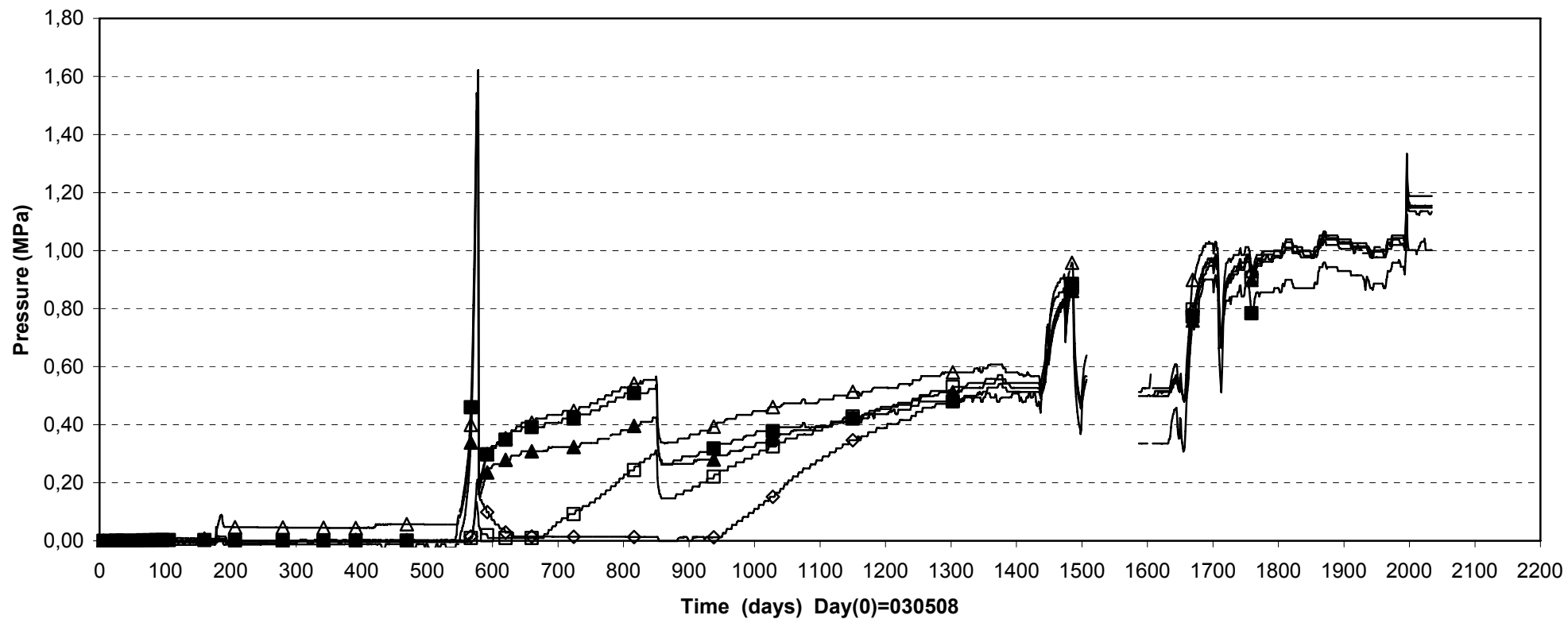

- ◇ UFA02 (Inner part\0\0\3554.1)
- UFA09 (F5-6\0\0\3548)
- △ UFA10 (F5-6\0\2.0\3548)
- ▲ UFA17(E5\2.3\0\3551)
- UFA18 (In front of plug\0\0\3539)

Prototype\ Backfill \ Section 2 (030508-081201)

Pore pressure - Kulite

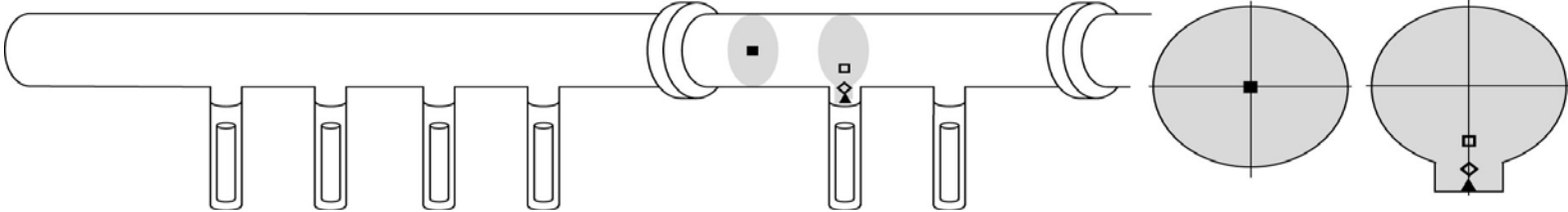
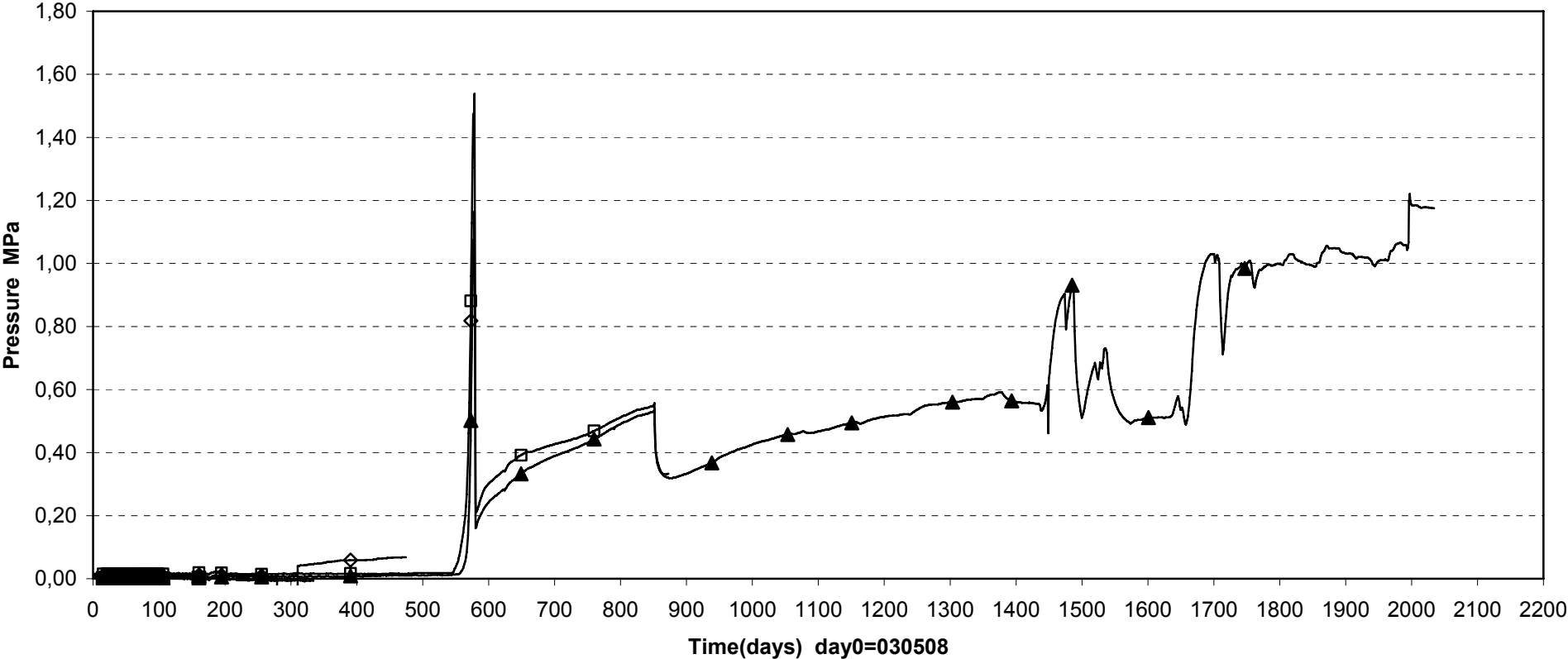

■ UFA01 (Inner part\0\0\3556) □ UFA04 (E5\0\ -1.75\3551) ◇ UFA05 (E5\0\ -2.6\3551) ▲ UFA06 (E5\0\ -3.15\3551)

Prototype\ Backfill \ Above dep.hole5 (030508-081201)
 Temperature - Pentronic

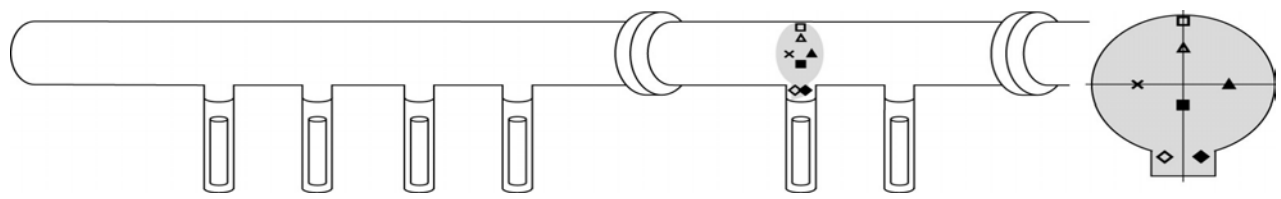
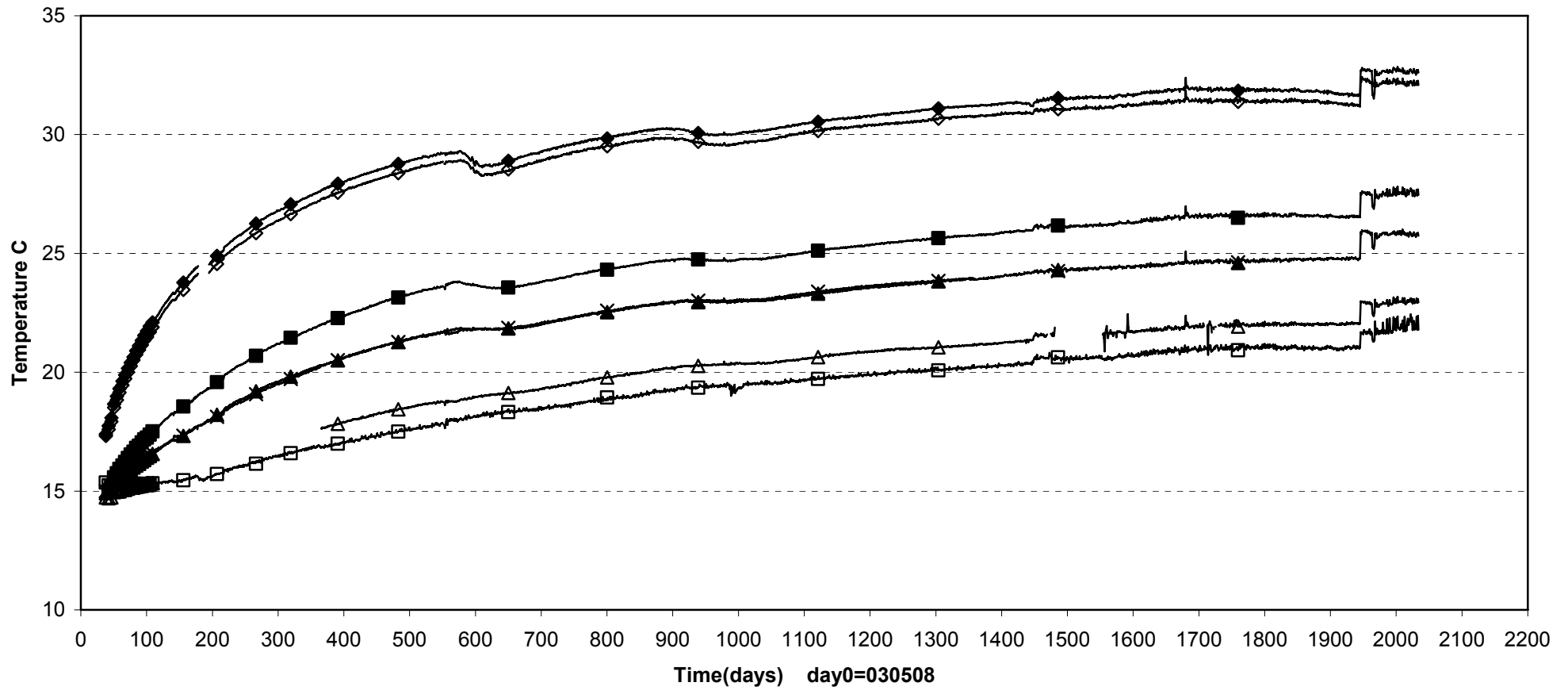

- | | | | |
|--------------------------|-------------------------|-------------------------|--------------------------|
| □ TFA01(E5\0.2.3\3551) | △ TFA02(E5\0.1.25\3551) | ■ TFA03(E5\0.0.8\3551) | ◇ TFA04(E5\0.5\2.6\3551) |
| ◆ TFA05(E5\0.5\2.6\3551) | × TFA06(E5\1.25\0\3551) | ▲ TFA07(E5\1.25\0\3551) | |

Prototype \ Backfill \ Between dep.hole 5-6 (030508-081201)
 Temperature - Pentronic

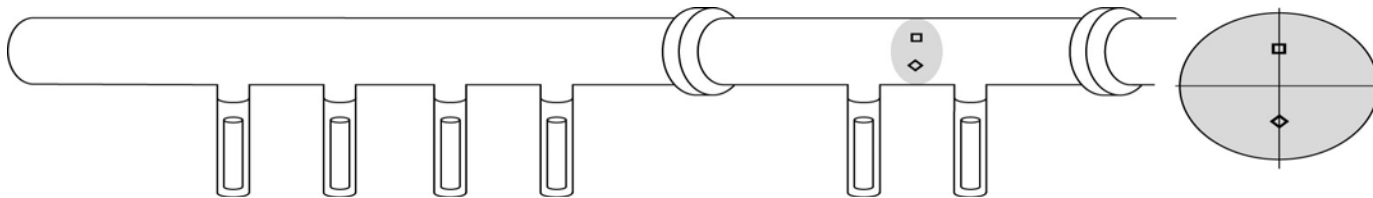
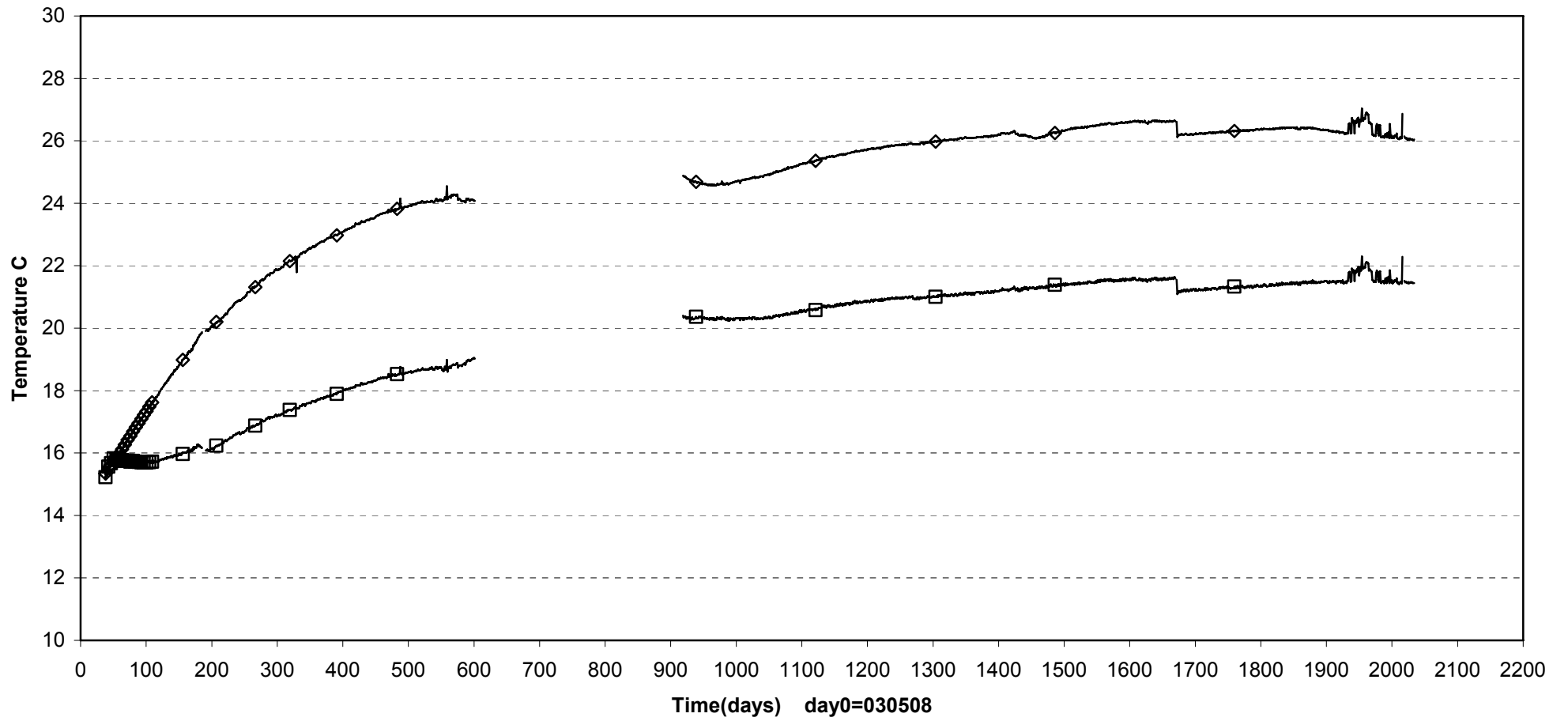

□ TFA08(F5-6\0\1.25\3548) ◇ TFA09(F5-6\0\1.25\3548)

Prototype\ Backfill \ Above dep.hole6 (030508-081201)
 Temperature - Pentronic

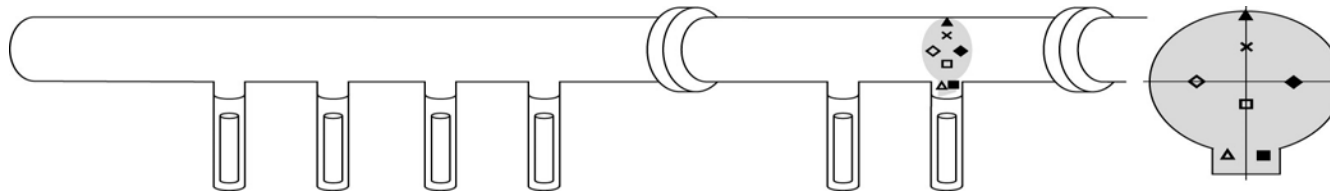
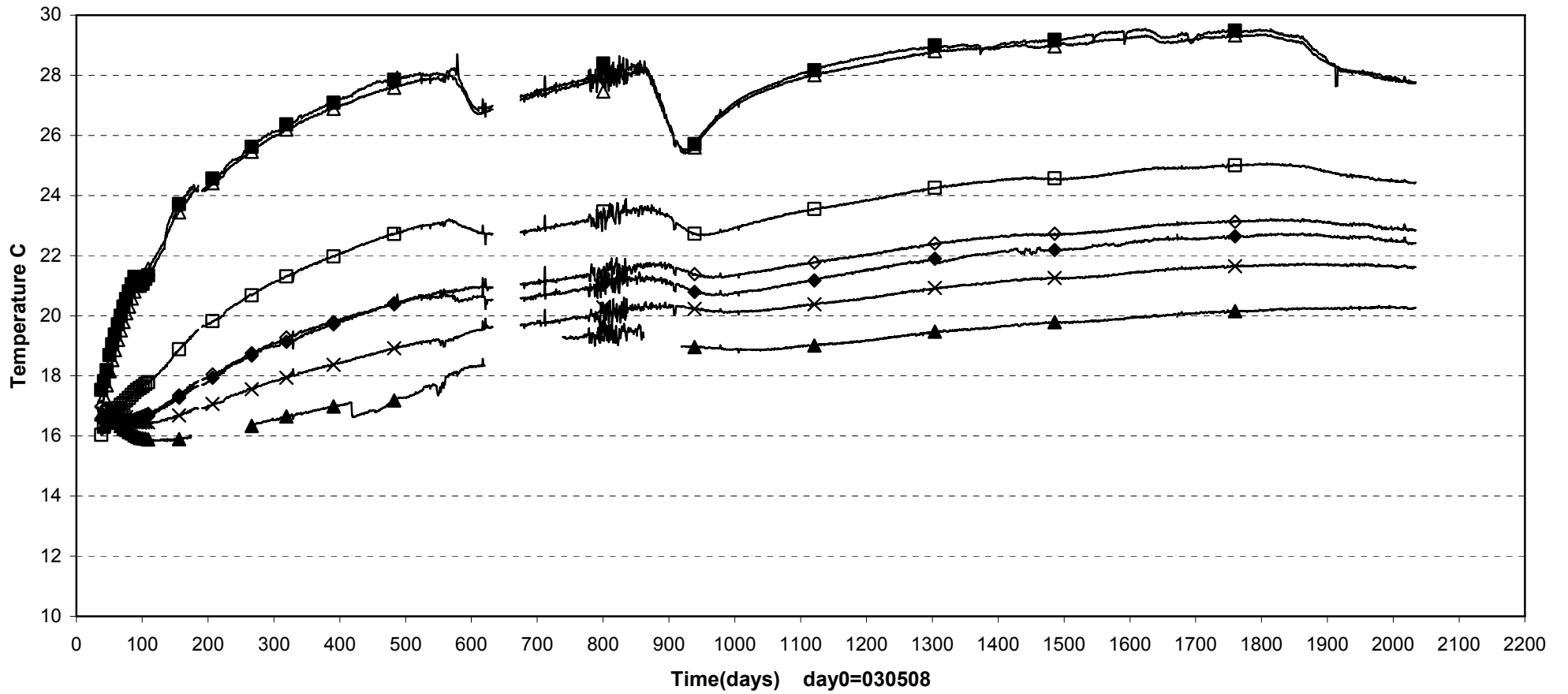

- | | | | |
|--------------------------|-------------------------|-------------------------|--------------------------|
| ▲ TFA10(E6\0\2.3\3545) | × TFA11(E6\0\1.25\3545) | □ TFA12(E6\0\0.8\3545) | △ TFA13(E6\0.5\2.6\3545) |
| ■ TFA14(E6\0.5\2.6\3545) | ◇ TFA15(E6\1.25\0\3545) | ◆ TFA16(E6\1.25\0\3545) | |

Appendix 8

Canister displacement tracking

Bárcena, I.



Aitemin
Centro Tecnológico

**PROTOTYPE REPOSITORY IN
OPERATION**

**CANISTER DISPLACEMENT
TRACKING**

I. Bárcena

January 2009

Contents

1	Layout	291
2	General comments	293
3	Deposition hole 3	295
3.1	Vertical sensors	295
3.2	Horizontal sensors	295
4	Deposition hole 6	297
4.1	Vertical sensors	297
4.2	Horizontal sensors	297
5	DATA PLOT deposition hole 3	299
6	DATA PLOT deposition hole 6	300
7	MONITORING SCREENS	301

1 Layout

The measurement of displacements is carried out in Section 1 on the canister in deposition hole 3. In Section 2 the displacements are measured on the canister in deposition hole 6. In deposition hole 3 six sensors are grouped into one measuring section, while in deposition hole 6 there are two measuring sections, at the bottom and on top of the canister, as shown in Figure 1.

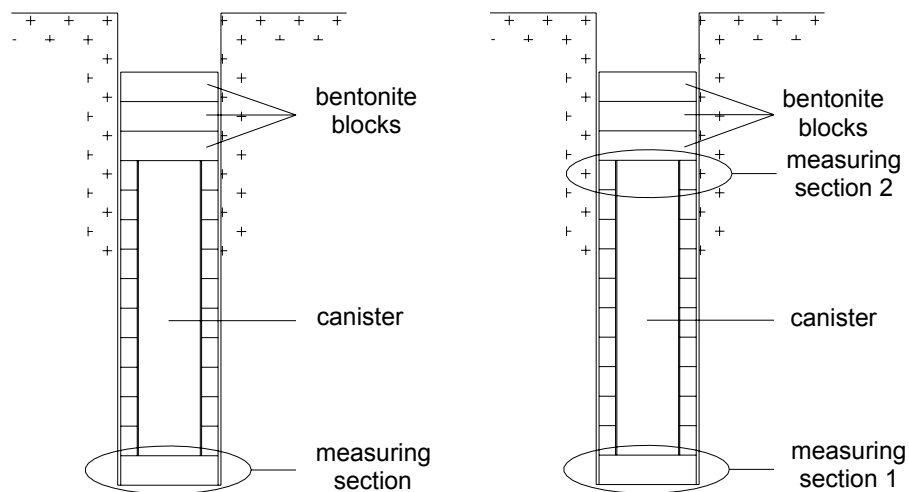

Figure 1. Location of measuring sections for deposition hole 3 (left) and deposition hole 6 (right)

For deposition hole No. 3 three sensors, named MCA30001 to MCA30003, have been placed in vertical position into holes drilled into the bottom bentonite block. These three sensors determine the vertical displacement of the canister, as well as any possible tilt. The points where the sensors are attached to the canister are the same as for the horizontal sensors.

The other three displacement sensors for deposition hole 3, named MCA30004 to MCA30006, are placed horizontally at the top of the lower bentonite block, close to the lower lid of the canister and attached to it, in a 120° radial disposition. Thus, the sensors will be always in a horizontal position, so that the horizontal displacement of the canister can be measured. The sensors have been placed so as to avoid interfering with other sensors installed in the block. Figure 2 illustrates the position of the six sensors.

For deposition hole 6 three sensors, named MC6001 to MC6003, have been placed in vertical position in the same way as for deposition hole 3. The horizontal sensors, named MCA60004 to MCA60006, have been placed in the same position as in deposition hole 3, but in the tenth bentonite ring, attached to the upper lid of the canister. Figure 3 shows the position of the sensors in this deposition hole.

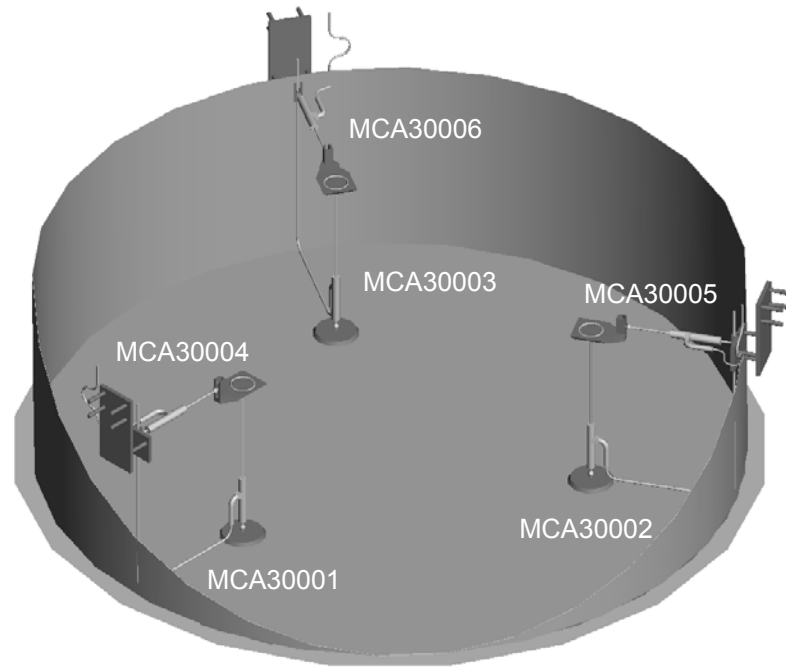

Figure 2. General view of sensors in deposition hole 3.

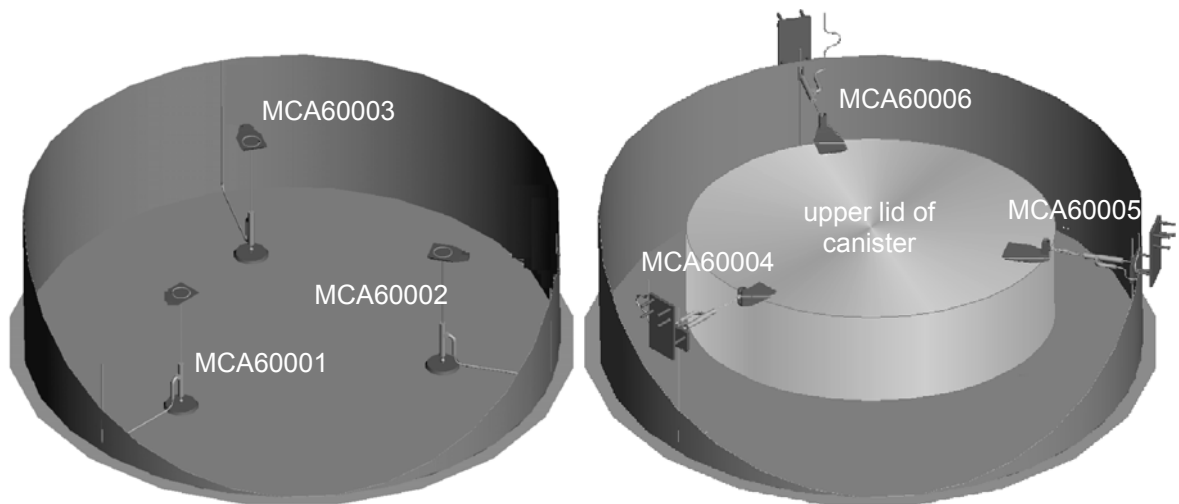

Figure 3. General view of vertical (left) and horizontal (right) sensors in deposition hole 6.

2 General comments

This is the eleventh “Prototype Repository in Operation” report issued for SKB, and the eighth semi-annual one, and contains data up to 081201 (days 2632 and 2034 for dep. holes 3 and 6).

Monitoring is carried out since 010623 in deposition hole 3 and since 030429 in deposition hole 6. Day 0 corresponds to 010917 for deposition hole 3 and to 030508 for deposition hole 6. Negative values correspond to a retraction of the transducer, which means vertical sinking or horizontal approaching to the rock surface, depending on the transducer position.

It can be clearly noticed in both holes the moment when the protection plastic sheet was removed, right before the backfilling of the tunnel. At that point, the sensors started registering displacements due to the bentonite swelling.

According to the measures carried out prior to the buffer installation, the water inflow in deposition hole 6 is two times that of deposition hole 3. This could be somewhat noticed when comparing the results from both holes, as the registered displacements in deposition hole 6 were much bigger in one year than those of deposition hole 3 in three years, and those differences have been increasing over the years.

The tunnel drainage was closed on 041101 (days 1141 and 543 for dep. holes 3 and 6) and re-opened on day 041206 (days 1176 and 578 for dep. holes 3 and 6). There was a power cut in all the canisters from 041202 (days 1172 and 574 for dep. holes 3 and 6) to 041215 (days 1185 and 587 for dep. holes 3 and 6).

In deposition hole 3, the closure and subsequent re-opening of the tunnel drainage seemed to have a high influence. In comparison, the power cut had little effect in general in this hole.

On the contrary, no significant effect from the drainage closure and re-opening could be noticed in deposition hole 6, where the effects from the power cut could be more clearly seen.

A major problem was detected in the computer of the Data Acquisition System in September 2005. As a consequence, no data could be registered from 050925 (days 1469 and 871 for dep. holes 3 and 6) to 060207 (days 1604 and 1006 for dep. holes 3 and 6), when the computer was checked “in situ” and put again in operation. On 060408 (days 1664 and 1066 for dep. holes 3 and 6) the computer failed again, so no data was registered from that date until the problem was fixed on 060616 (days 1733 and 1135 for dep. holes 3 and 6) by replacing the computer’s full hard drive. Another fails in the computer resulted in data loss from 070813 (days 2156 and 1558 for dep. holes 3 and 6) to 070930 (days 2204 and 1606 for dep. holes 3 and 6) and from 080425 (days 2412 and 1814 for dep. holes 3 and 6) to 080513 (days 2430 and 1832 for dep. holes 3 and 6).

The computer failed again in September 2008, so no data could be registered from 080930 (days 2570 and 1972 for dep. holes 3 and 6) until the end of the reported period. A new computer is being configured to replace the existing one.

Two sensors out of the 12 installed have failed permanently during the monitoring phase. These are MCA30002, one of the vertical sensors in deposition hole 3, which failed on 020112 (day 117 for dep. hole 3), and horizontal sensor MCA60006 in deposition hole 6, which failed during the data blackout from 050925 to 060207 (days 871 to 1006 for dep. hole 6). Vertical sensor MCA60002 failed on 050428 (day 721 for dep. hole 6) and recovered on 050602 (day 756 for dep. hole 6), but afterwards, during certain periods registered oscillating values (not shown in the data plots), so some doubts remain about its reliability.

The results obtained in both deposition holes are described hereafter. Monitoring screens correspond to data of 080601 (days 2449 and 1851 for dep. holes 3 and 6).

3 Deposition hole 3

3.1 Vertical sensors

Two vertical sensors are still in operation in this deposition hole. After an initial small rise of about 0.5 mm, the sensors showed a fast canister sinking that reached about 2 mm below the initial level, when, most likely due to the re-equilibration of pressures below and above the canister, the decrease ceased and the canister started to rise again.

From day 1163 (041123), a fast sink of the canister could be noticed, in both vertical sensors at the same time. This could be due to the increase of pressure on top of the canister caused by the closure of the tunnel drainage, which was done 23 days before, on day 1141 (041101). The canister sank 3 mm in two weeks, until day 1176 (041206) when the drainage was opened again. On that point the canister experienced a fast rise, of one mm in one day.

Afterwards one of the vertical sensors (MCA30003) kept showing an elongation at a similar slow rate as before the events, while in the other vertical sensor still operative (MCA30001) the trend changed to a slight retraction. This could indicate that a small canister tilting has been taking place, although the third value for defining the plane of the canister base is unavailable, and no clear signs of tilting have been noticed in the corresponding horizontal sensors.

The retraction trend of sensor MCA30001 stopped about two years ago, being this sensor in a nearly constant value since. Lately, the elongation of sensor MCA30003 seems to have stopped too.

3.2 Horizontal sensors

At the start of the monitoring phase, two of the horizontal sensors registered an initial small retraction, while the third one registered a similar elongation, all in the order of half of millimetre. This could indicate a horizontal displacement of the canister. Afterwards, the two sensors showing retraction changed to elongations of about 0.5 mm and 1.5 mm. One of the changes was very fast. No changes were registered in the third sensor, so it is not clear that this is due to a horizontal displacement of the canister. A possible explanation for this behaviour is that it is due to the vertical movement of the canister, although in principle the anchoring points of the horizontal sensors were conceived not to be affected by vertical displacements of the canister.

No changes were registered afterwards until 041127 (day 1167 for dep. hole 3), when one of the horizontal sensors showed a fast elongation, followed by a retraction. This behaviour could reflect again the vertical displacement of the canister detected in the same dates, given that the shape of the plot matched exactly the vertical movement and that the other two horizontal sensors did not show any displacement.

The retraction trend shown by sensor MCA30005 seems to be slowing down lately, while sensor MCA30006 shows a fast elongation of about 0.5 mm, and sensor MCA30004 remains still. Hence, a clear correlation to a movement of the canister, either horizontal or vertical, cannot be established so far, so further tracking is necessary.

4 Deposition hole 6

4.1 Vertical sensors

The vertical sensors have maintained their trends from the start of the monitoring phase, showing a constant rise of the canister. Although one of the sensors started increasing later than the other two, all the three have been in similar values until the first data blackout, what indicates that no tilting of the canister had taken place up to that moment. Lately, the rate seems to be stabilising, with values over 12 mm in the two reliable sensors. The third one dropped below zero, but as already commented, some doubts remain about its reliability. This could be explained also by a break of the attachment canister-sensor.

4.2 Horizontal sensors

The horizontal sensors showed some fast initial movement at first, with elongation of two sensors and retraction of the third one, what could indicate a canister movement towards this one in the order of 1 mm. Afterwards, one of the elongated sensors, MCA60005, started increasing at a rate similar to the vertical sensors, reaching almost 11 mm and still increasing. These sensors are provided with sliding anchorages at both ends so to register only horizontal movements of the canister independently of any vertical movement. However, in this case the plot shape suggests the elongation of this sensor corresponding to the vertical movement of the canister, due to the sticking of one of the sliding anchorages.

The other two sensors have remained more or less constant except for an elongation of between 1 mm and 2 mm occurred during a few months from about 041228 (day 600 for dep. hole 6), following the closure and re-opening of the tunnel drainage. Sensor MCA60006 failed during the data blackout, so no information could be obtained from it afterwards. No changes in the trends are noticed during the last two and a half years.

5 DATA PLOT deposition hole 3

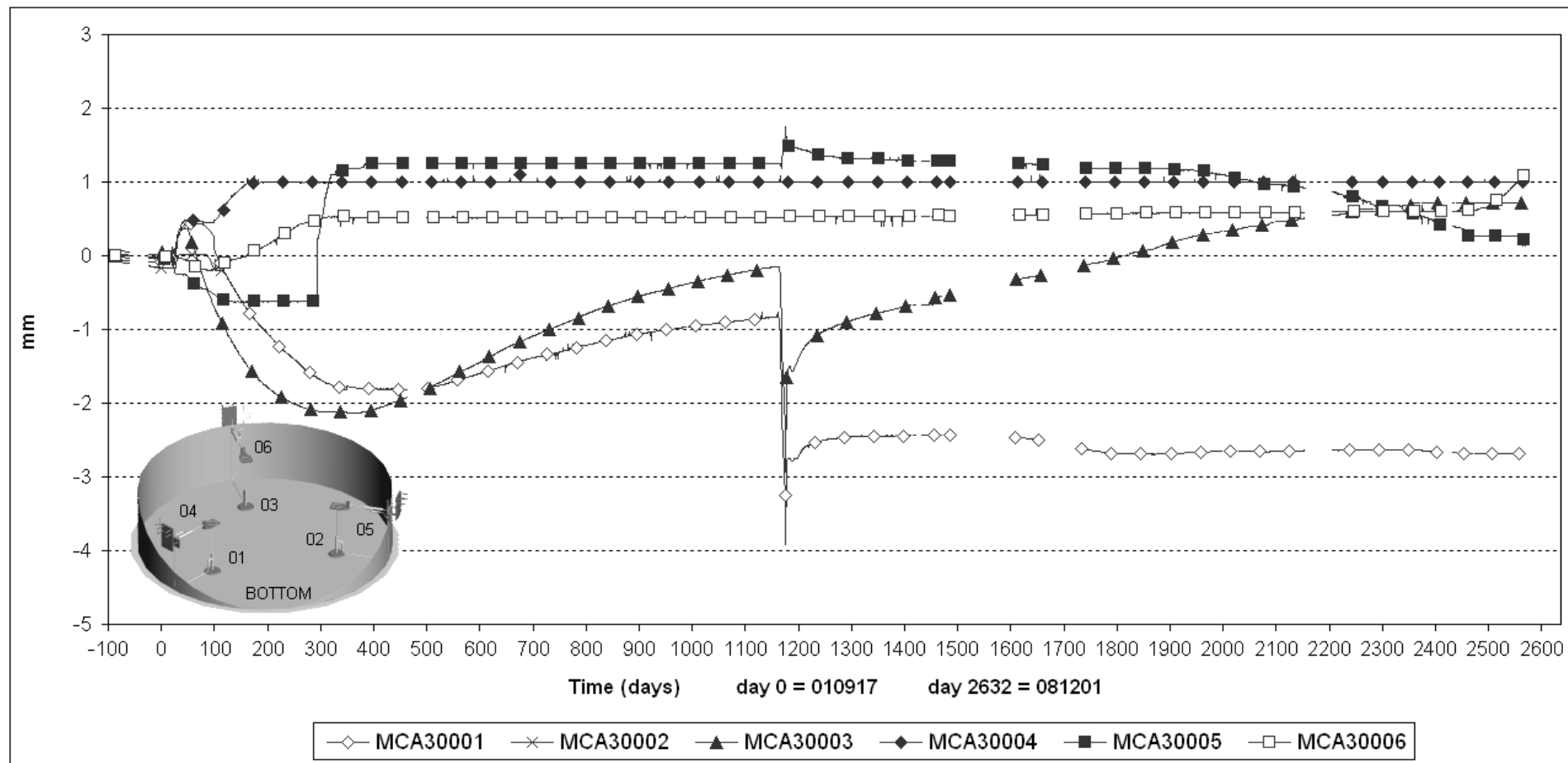

6 DATA PLOT deposition hole 6

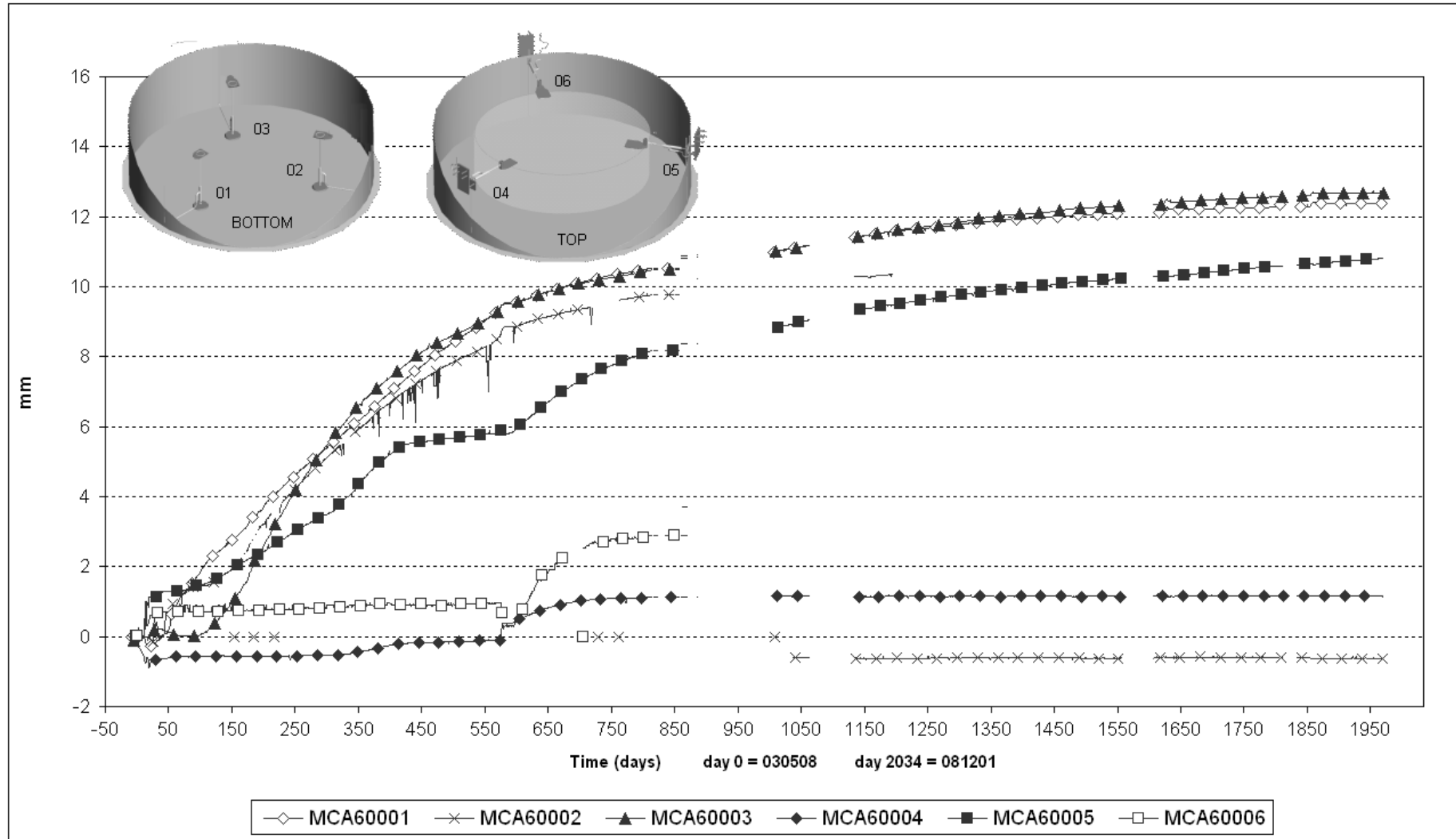

7 MONITORING SCREENS

Signal

Displacement

Rel. Displ.

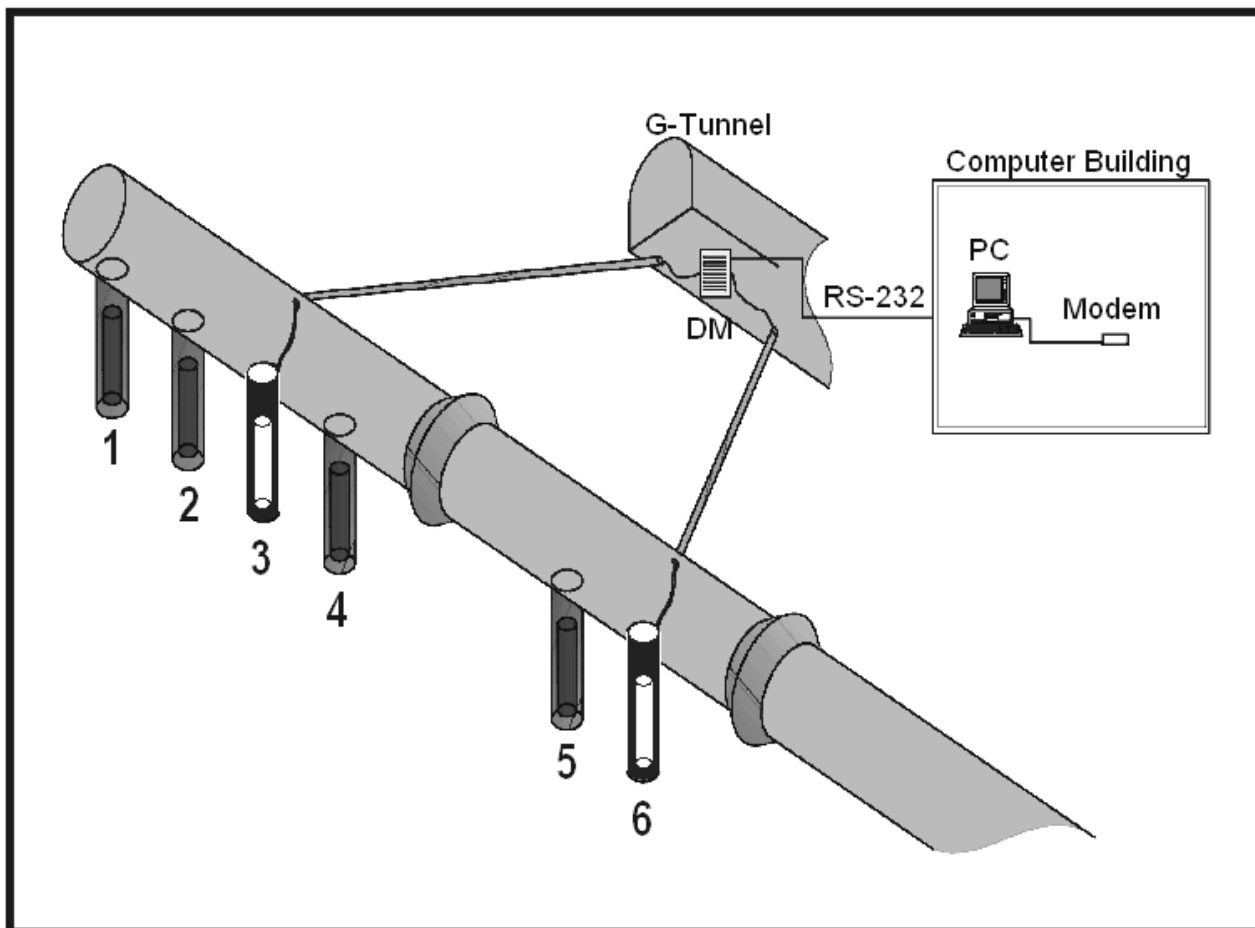

Deposition Hole 3

MCA30001	-2,68014 mm
MCA30002	no signal
MCA30003	0,71203 mm
MCA30004	1,00038 mm
MCA30005	0,21720 mm
MCA30006	1,09449 mm

Deposition Hole 6

MCA60001	12,39285 mm
MCA60002	-0,61961 mm
MCA60003	12,68963 mm
MCA60004	1,17553 mm
MCA60005	10,81437 mm
MCA60006	no signal

12:00:03 01/12/08

DEPOSITION HOLE 3

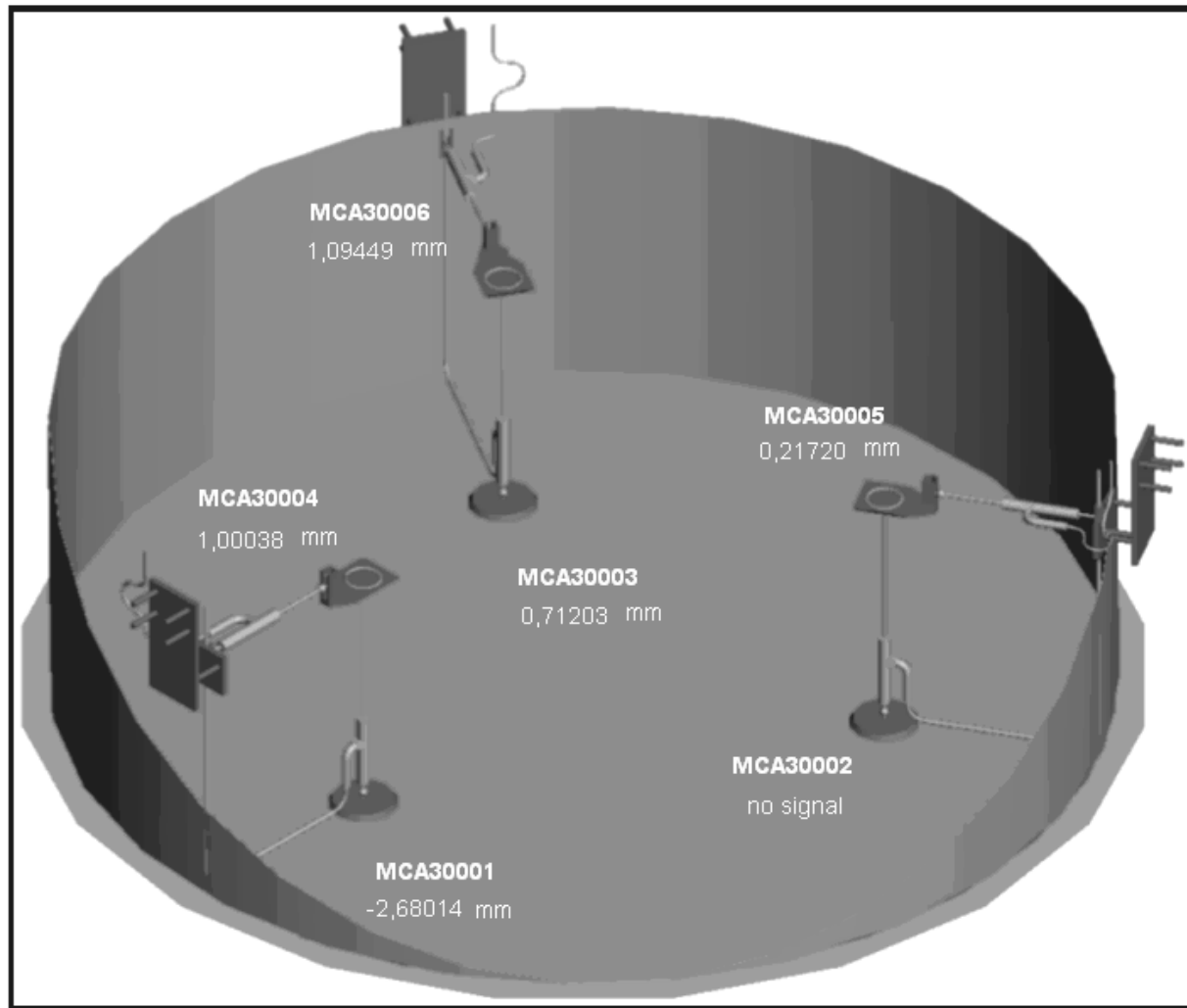

Signal Displacement

Rel. Displ.

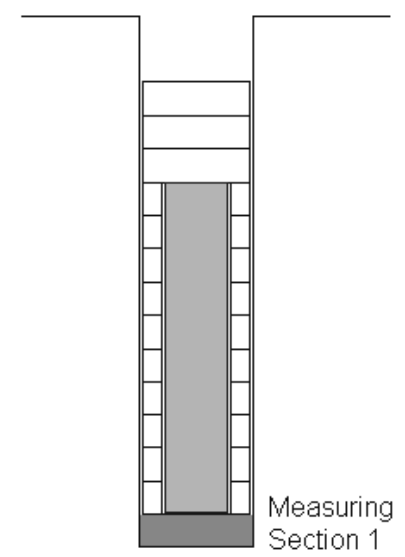

BACK

12:01:27 01/12/08

DEPOSITION HOLE 6

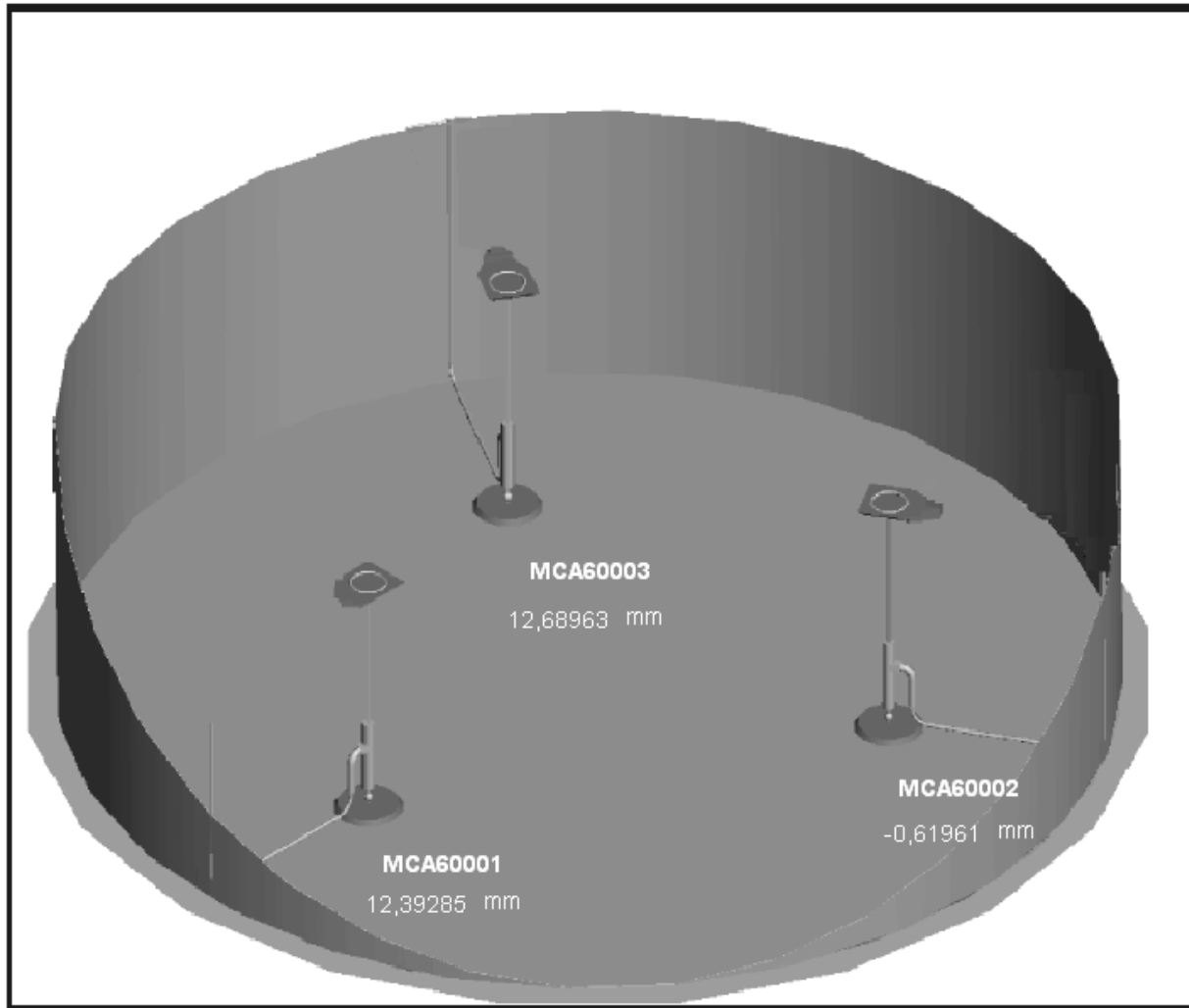

Signal Displacement

Rel. Displ.

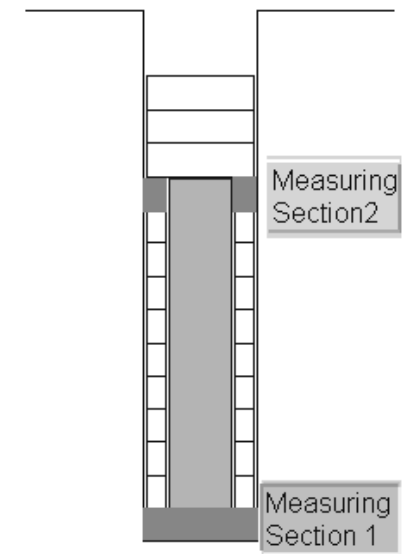

BACK

12:01:57 01/12/08

DEPOSITION HOLE 6

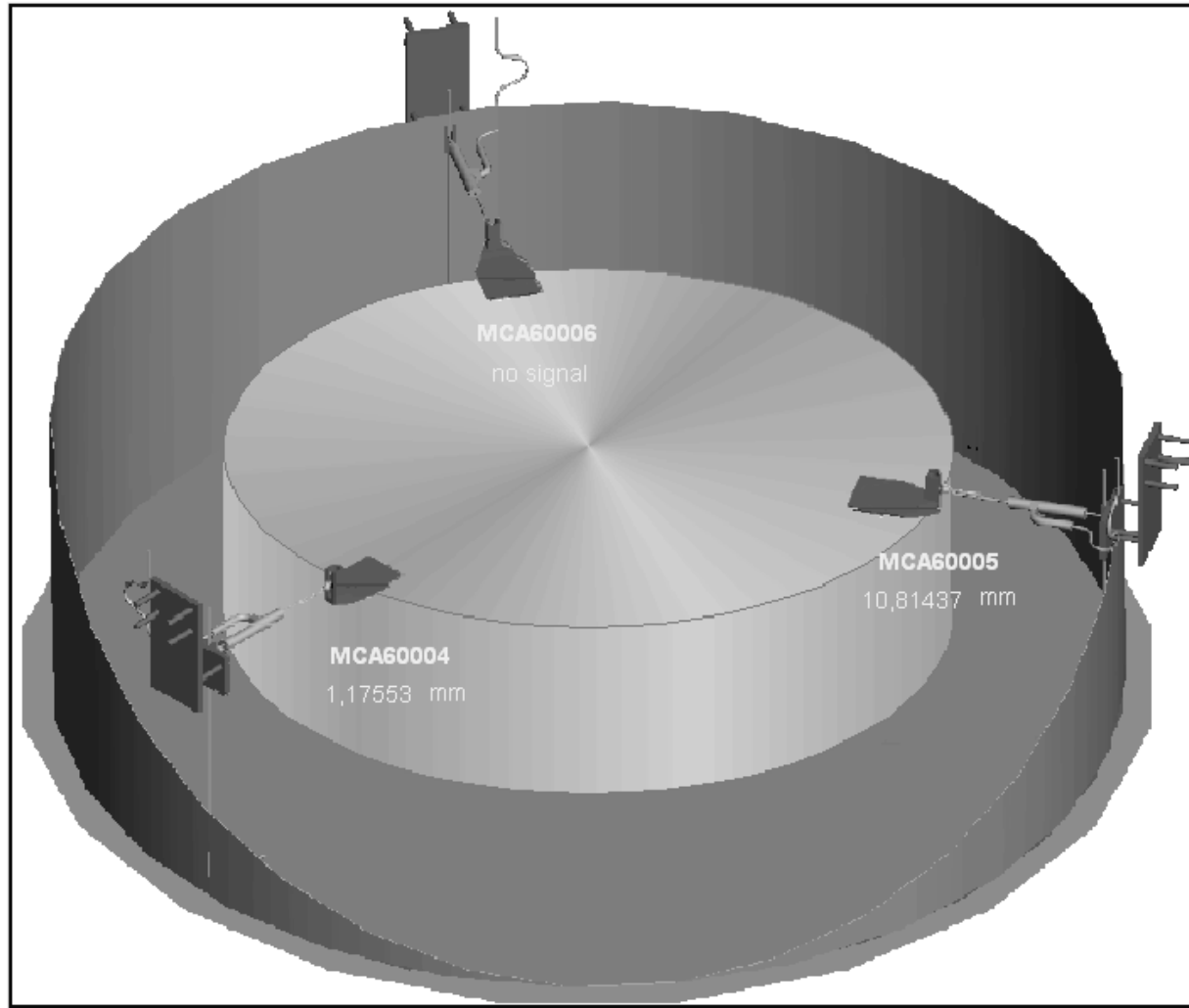

Signal Displacement

Rel. Displ.

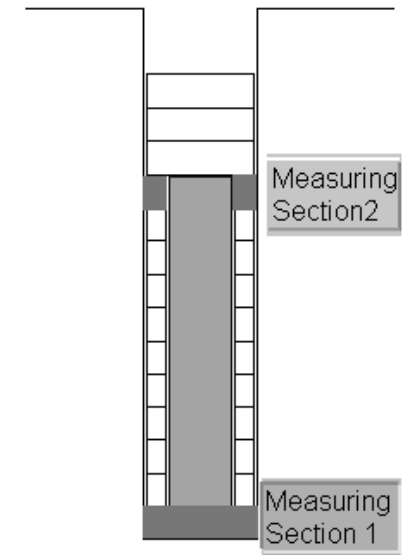

BACK

12:02:16 01/12/08

Appendix 9

Geoelectric monitoring

Wieczorek Klaus, GRS



Gesellschaft für Anlagen-
und Reaktorsicherheit
(GRS) mbH

Prototype Repository Project

**Data Report
Geoelectric Monitoring**

Status: 26 February 2009

Written by: WIE, ROT

Approved by: ROT

Contents

1	Introduction	311
2	Backfill Section 1	313
2.1	Layout of electrode array in the backfill of section 1	313
2.2	Tomograms of the backfill array in section 1	314
2.3	Actual Interpretation	324
3	Backfill Section 2	327
3.1	Layout of electrode array in the backfill of section 2	327
3.2	Tomograms of the backfill array in section 2	327
3.3	Actual Interpretation	335
4	Rock Section 2	337
4.1	Layout of electrode array in the rock between deposition boreholes 5 and 6	337
4.2	Tomograms of electrode arrays in the rock	338
4.3	Actual Interpretation	348
5	Buffer in Borehole 5 in Section 2	349
5.1	Layout of electrode array in the buffer of deposition boreholes 5	349
5.2	Tomograms of electrode array in the buffer	350
5.3	Actual Interpretation	355

1 Introduction

Within the frame of research activities in the prototype repository at Äspö GRS employs measurements of electrical resistivity to monitor water uptake in the drift backfill, the borehole buffer, and desaturation effects around one of the deposition boreholes.

The electrical resistivities in the buffer, the backfill, and around the boreholes are determined by use of multi-electrode arrays. The arrays consist of electrode chains. The resistivity distribution in the areas between the chains is determined by means of tomographic dipole-dipole measurements. The recording unit for these arrays is controlled remotely from Braunschweig / Germany via a telephone connection, which allows daily measurements of the in-situ resistivity distribution. From the measured apparent resistivity values the "true" resistivity distributions in the different parts are computed applying the latest inversion software.

In the geoelectric measurements advantage is taken of the dependence of the electrical resistivity in materials on the water (solution) content. In order to interpret the resistivity values in terms of water content the data are to be compared with laboratory calibration results which are available for the different materials.

In the following, the calculated inversion data for the different arrays are provided in the form of tomograms. Additional data for smaller time periods can be made available on demand.

2 Backfill Section 1

2.1 Layout of electrode array in the backfill of section 1

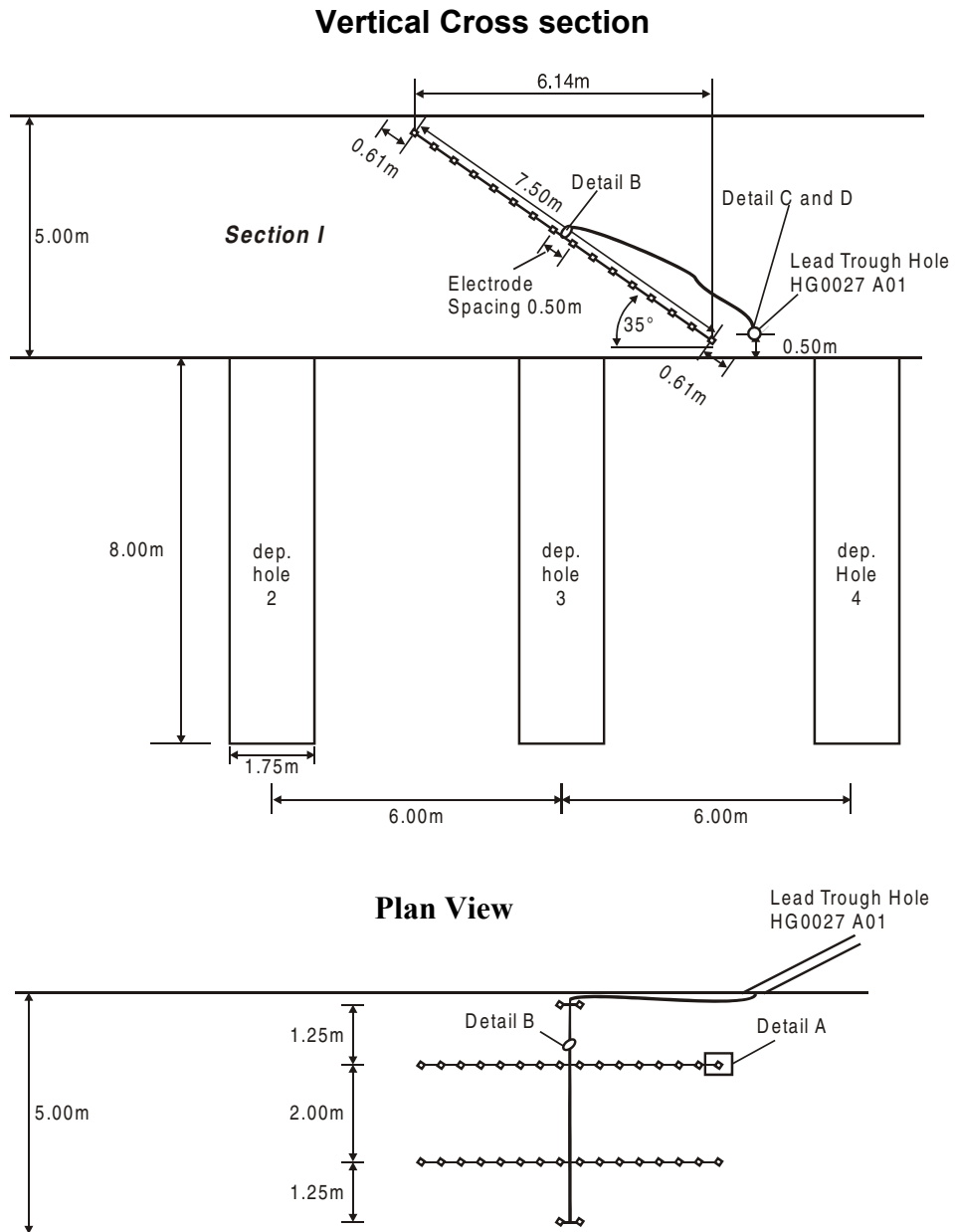
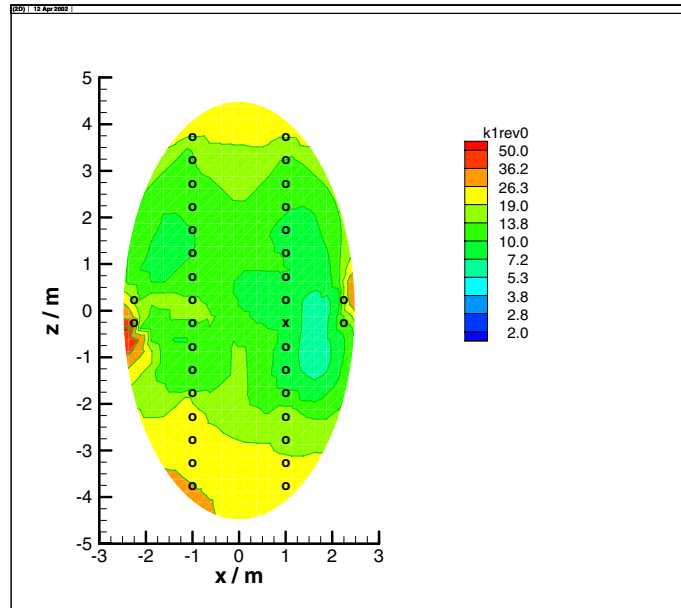
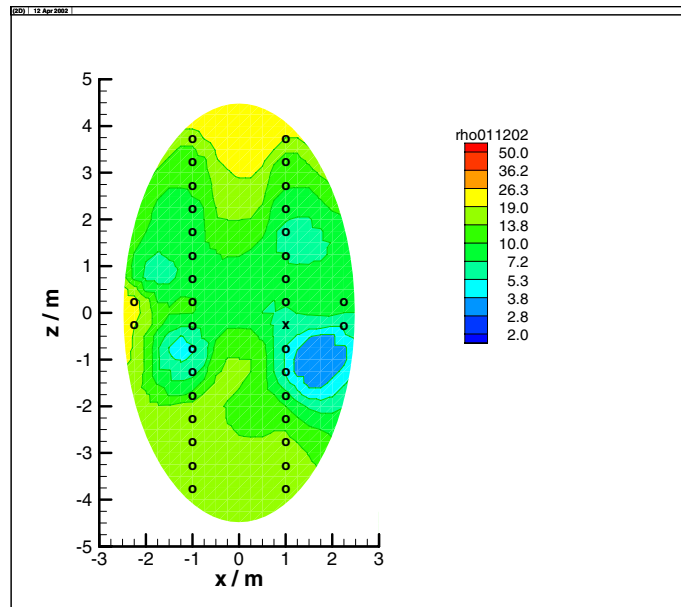

Figure 2-1. Electrode array in the backfill in section 1.

2.2 Tomograms of the backfill array in section 1



2001-10-27



2001-12-02

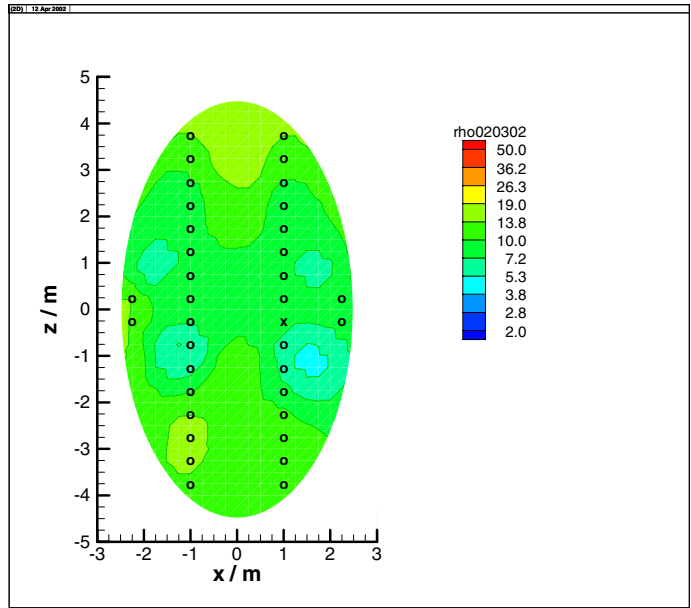

2002-03-02

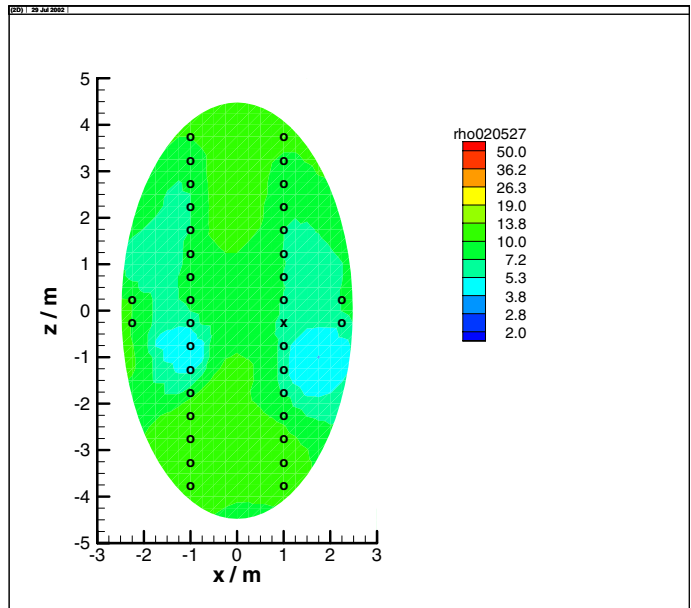

2002-05-27

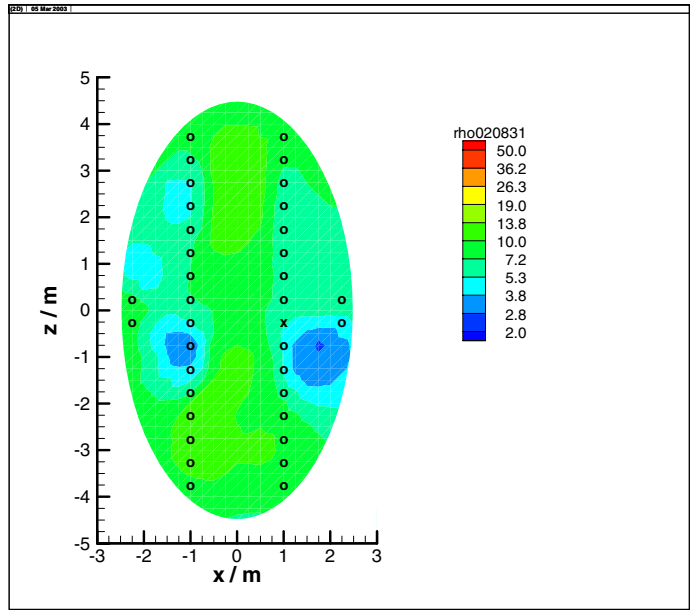

2002-08-31

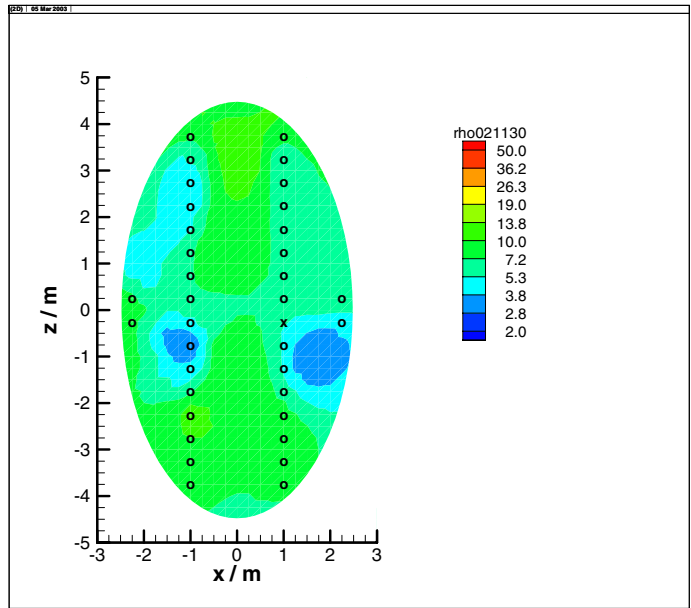

2002-11-30

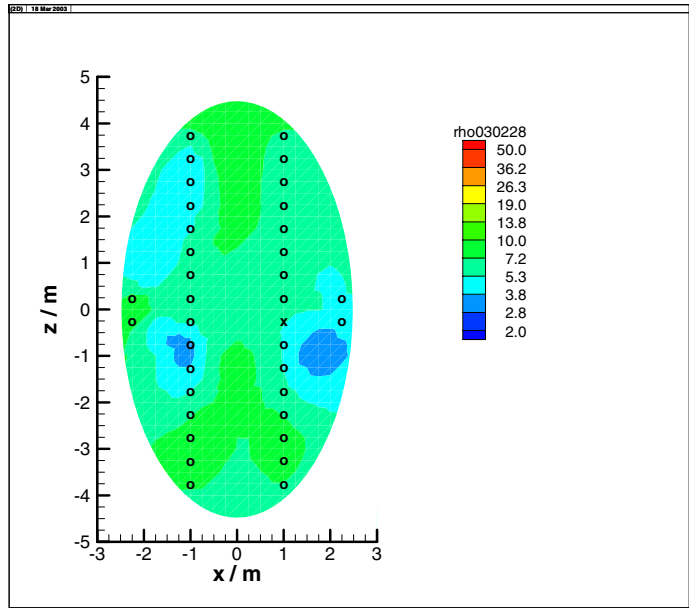

2003-02-28

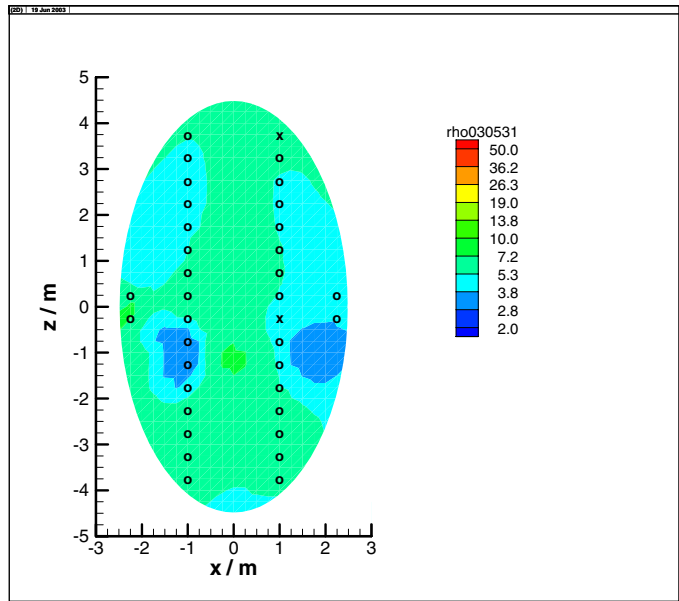

2003-05-31

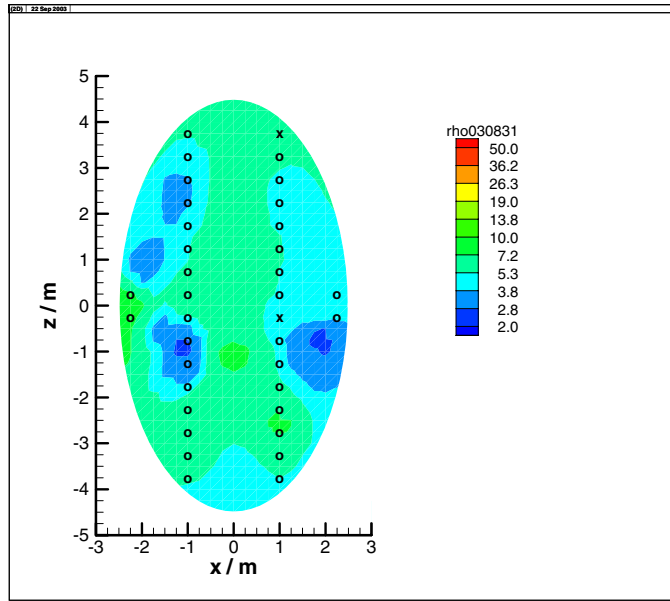

2003-08-31

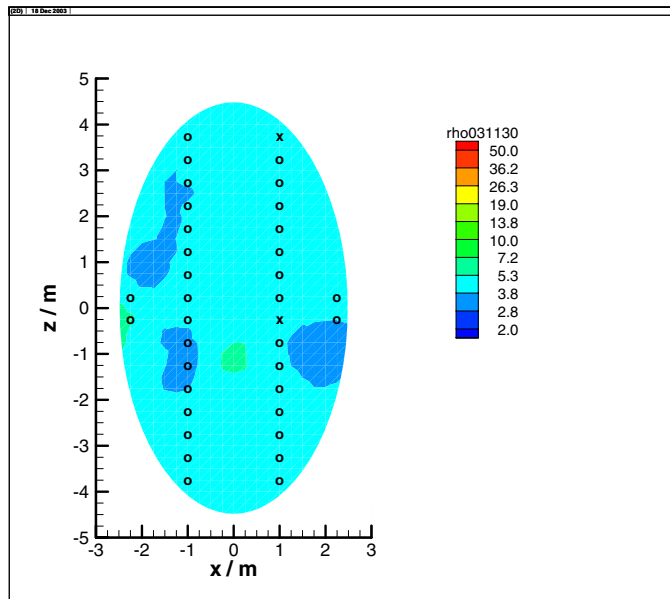

2003-11-30

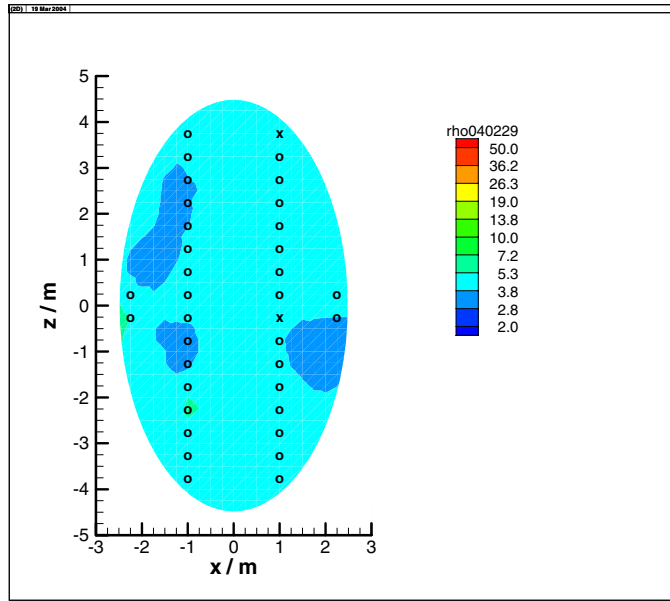

2004-02-29

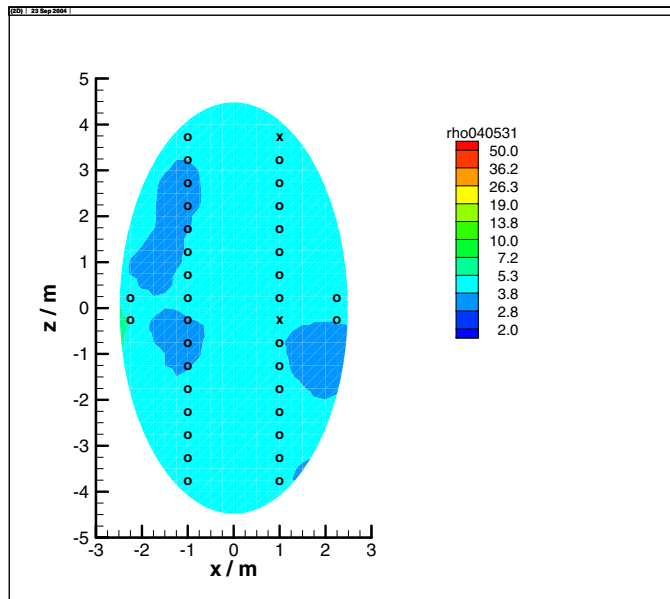

2004-05-31

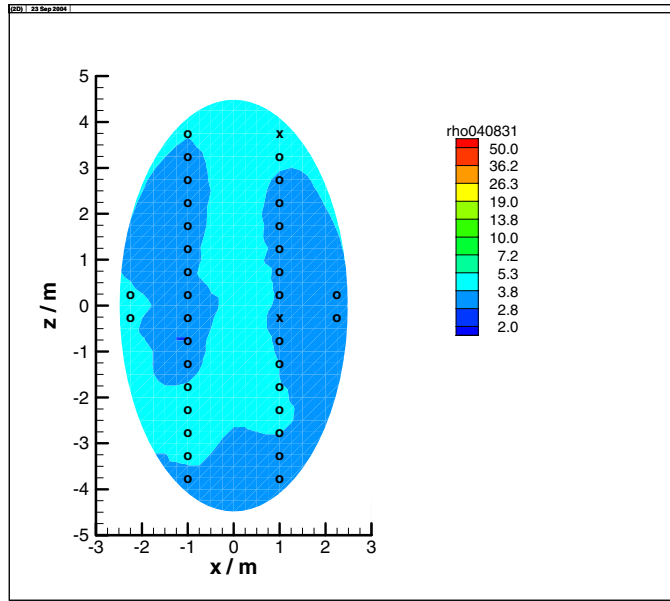

2004-08-31

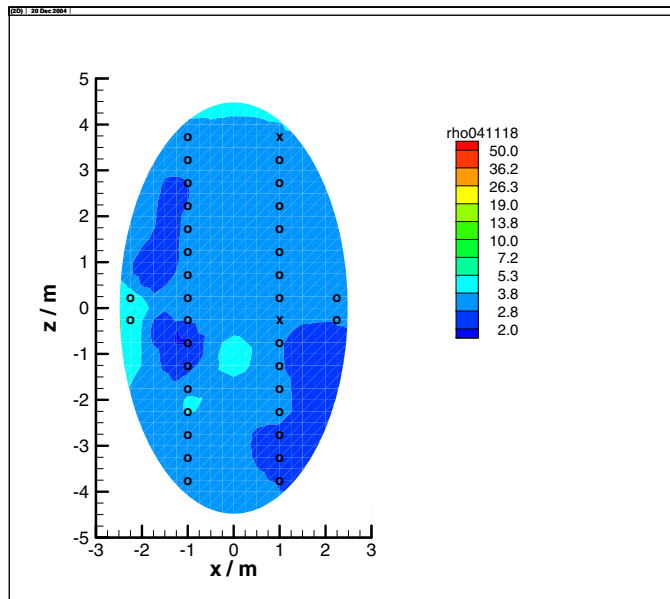

2004-11-18

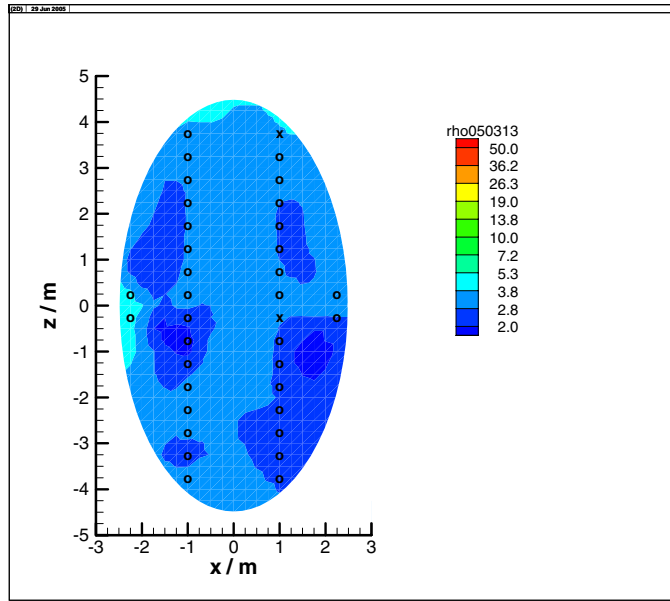

2005-03-13

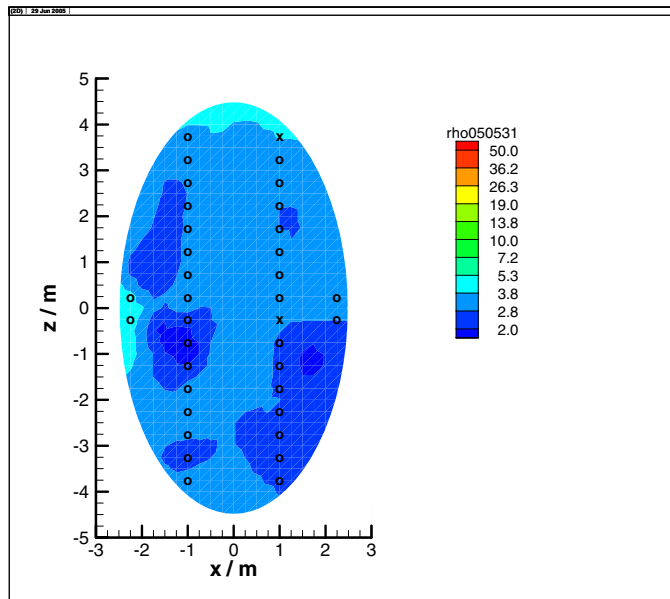

2005-05-31

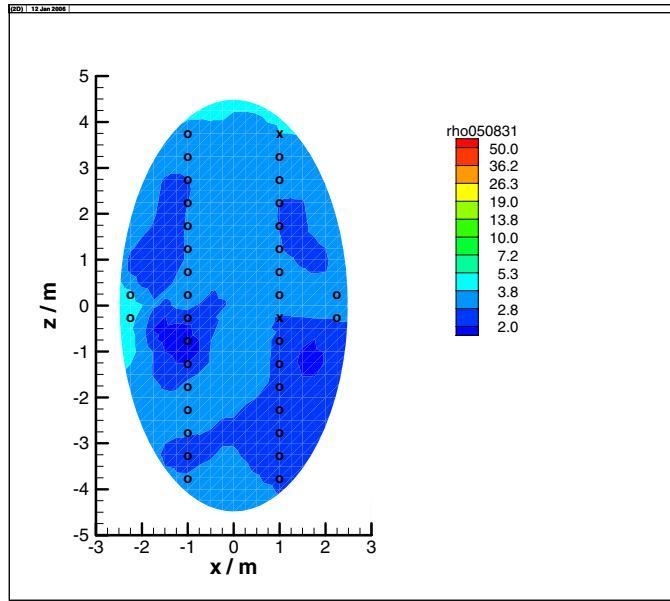

2005-08-31

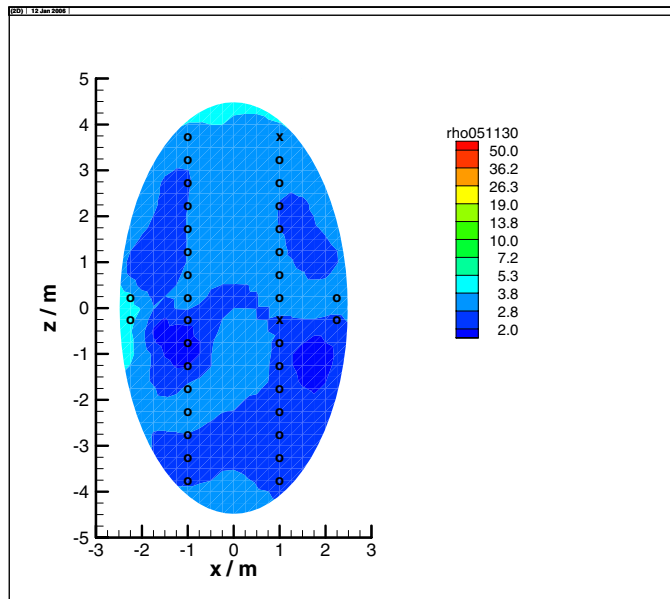

2005-11-30

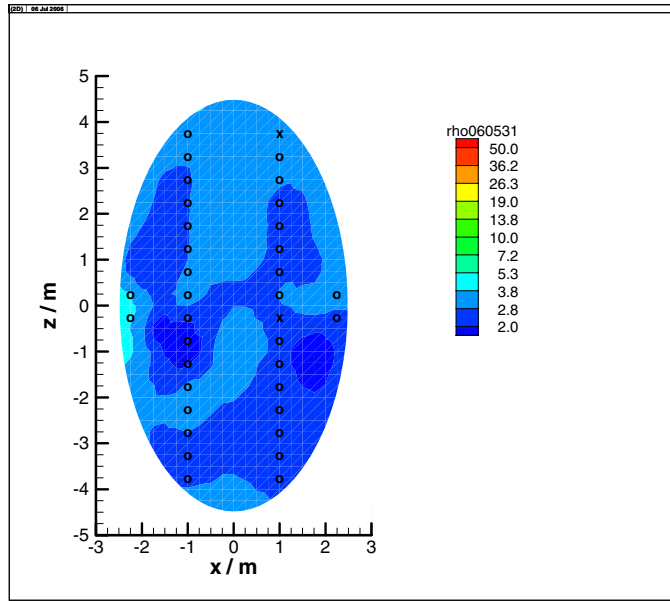

2006-05-31

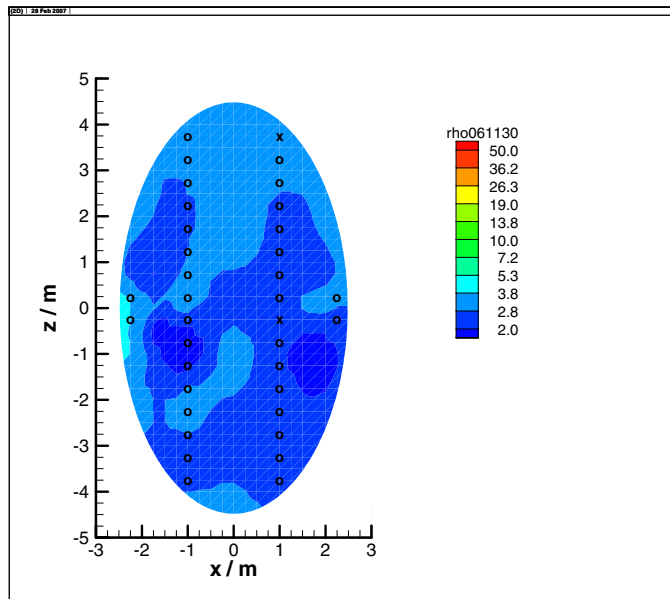

2006-11-30

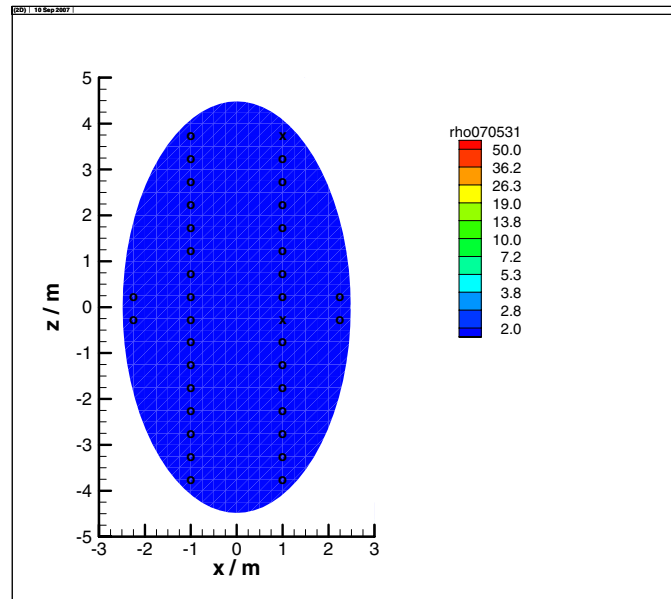

2007-05-31

2.3 Actual Interpretation

The initial resistivity value of the backfill in October 2001 is about 10 to 14 Ωm corresponding to a water content of 13 to 14%. In the following month the resistivity reduces to about 7 to 10 Ωm which corresponds to a water content of about 14 to 16%. However, this reduction in resistivity is most likely generated by the wet (light blue) areas close to the electrode chains. These wet areas are the consequence of moistened backfill used during installation of the electrodes for better covering of the electrode chains. From then on, the resistivity decreases continuously, starting near the drift walls and progressing into the drift centre. From November 2004 on, a very homogeneous resistivity distribution was reached; with a value around 3 Ωm corresponding to a water content of 21 - 22 %.

Besides the overall trend, minor changes in the tomograms from month to month are visible near the edges of the gallery, especially a light blue area on the right side of the tomograms is more or less pronounced. These are no real anomalies, but are caused by the fact that inaccuracies in the measurements can lead to the accumulation of "ghost" anomalies in areas of lower sensitivity. The areas of lower sensitivity are typically the edges of the model. In case of the blue area on the right side of the tomograms, the sensitivity is more reduced because one of the electrodes (marked with an "x" in the tomograms) is not active, as its cable broke after installation during backfilling.

The resistivity is also slightly decreased by the temperature increase in the backfill. The temperature increase can result in a resistivity reduction by not more than 1 Ωm .

On May 2, 2003, the upper right electrode (also marked with an "x" in the tomogram from May 31, 2003) was lost. The reason is probably a cable failure. It is not clear whether this is already a corrosion effect.

The tomogram of May 2007 shows that the resistivity was below $2.8 \Omega\text{m}$ everywhere in the backfill then. To get more detailed information, the tomograms below show the resistivity distribution of May 2007, November 2007, and September 2008 in a higher resolution. Resistivity was in fact below $2 \Omega\text{m}$ in all of the backfill during 2007, with the values near the walls being slightly lower than in the center. In 2008, however, resistivity seems to have increased again. The respective tomograms show a slight increase in the entire cross section and a center of elevated resistivity above $5 \Omega\text{m}$ near the tunnel roof. The reason for this is unclear at the time being; the resistivity evolution has to be monitored further.

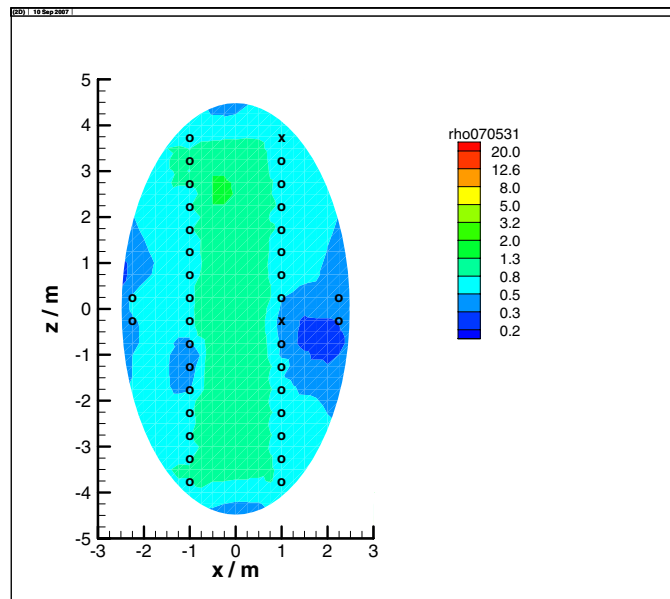

2007-05-31 (higher resolution)

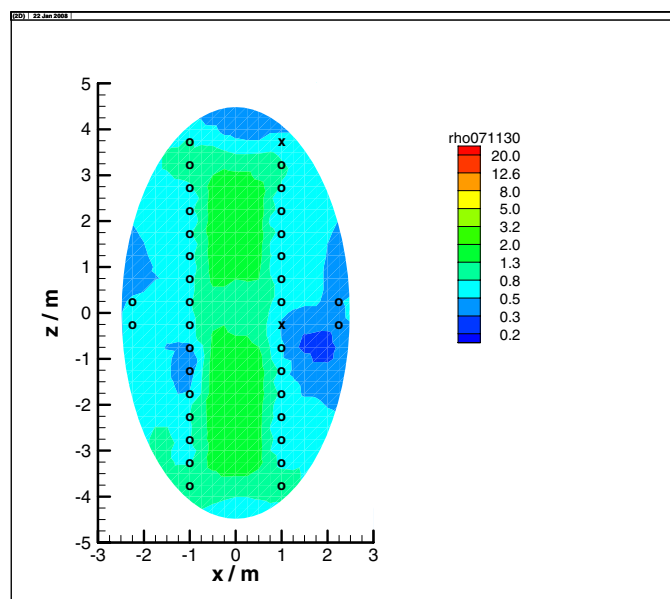

2007-11-30 (higher resolution)

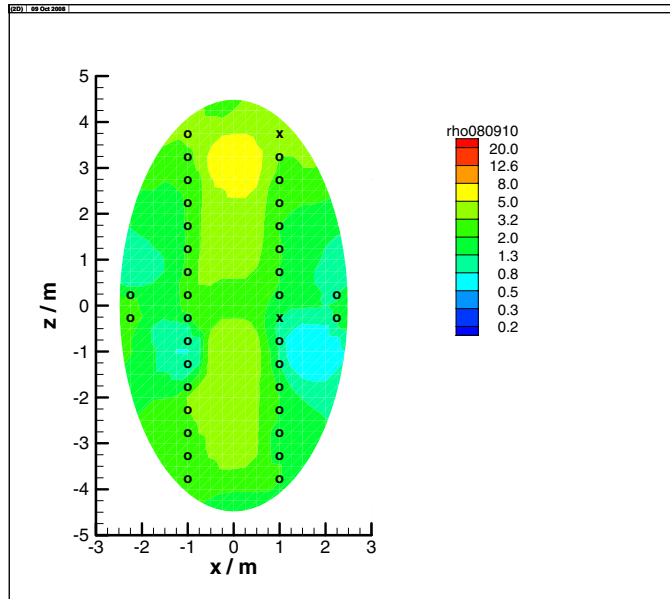

2008-09-10 (higher resolution)

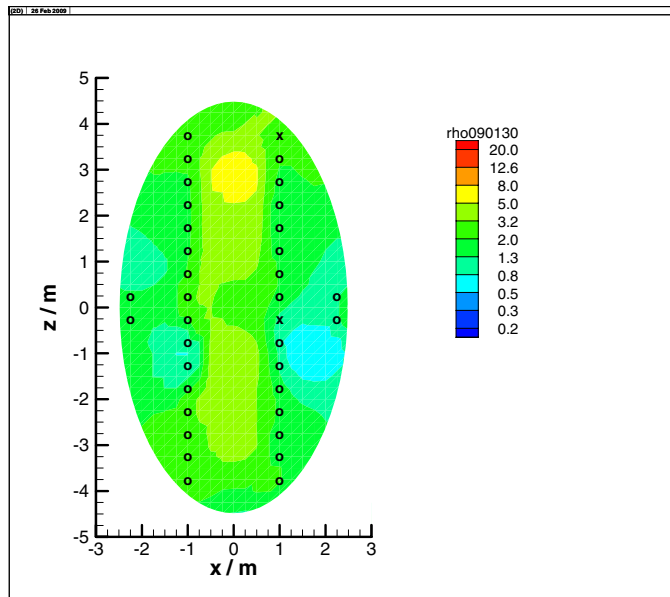

2009-01-30 (higher resolution)

3 Backfill Section 2

3.1 Layout of electrode array in the backfill of section 2

The array layout in the backfill of section 2 is identical to that located in section 1, except for the fact that the array has been placed above deposition borehole #6 instead of #3.

3.2 Tomograms of the backfill array in section 2

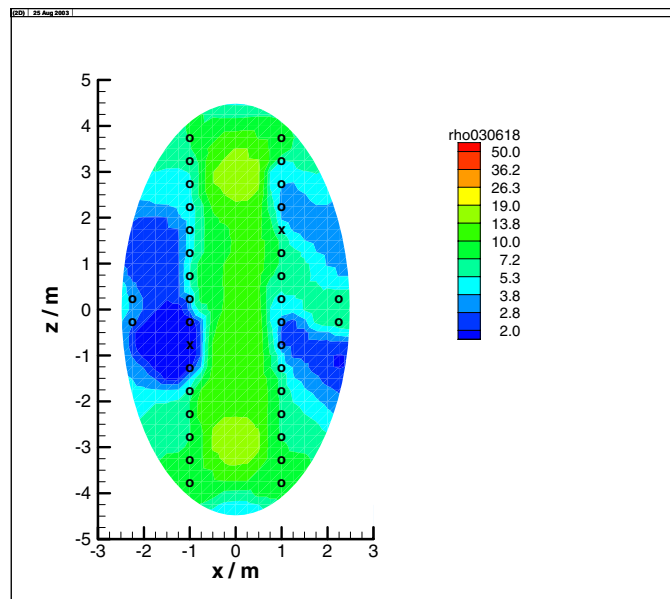

2003-06-18

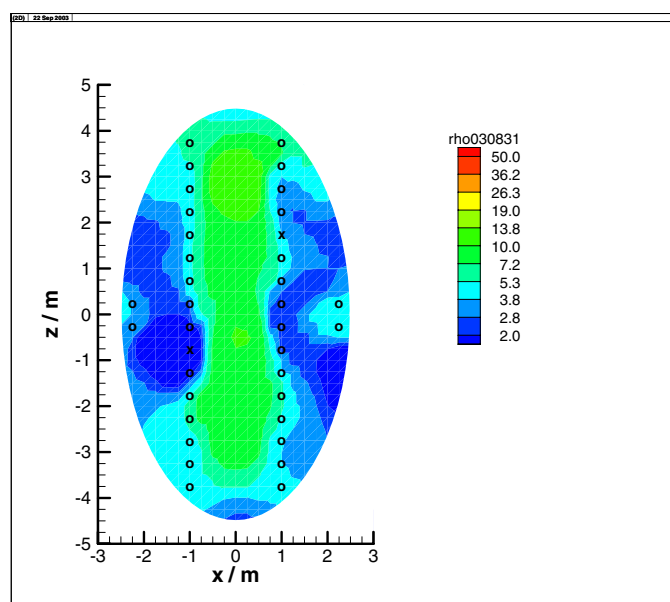

2003-08-31

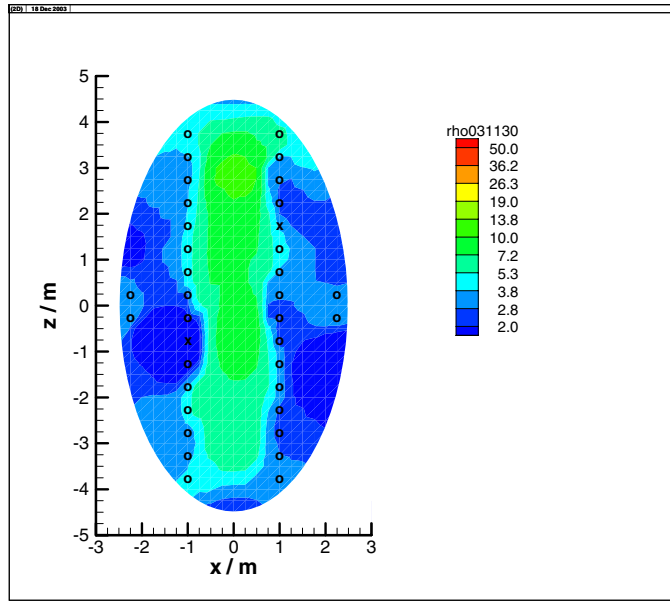

2003-11-30

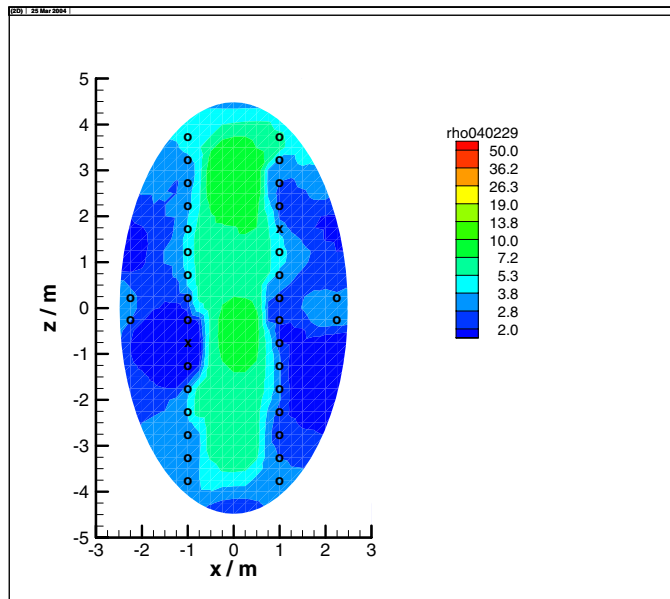

2004-02-29

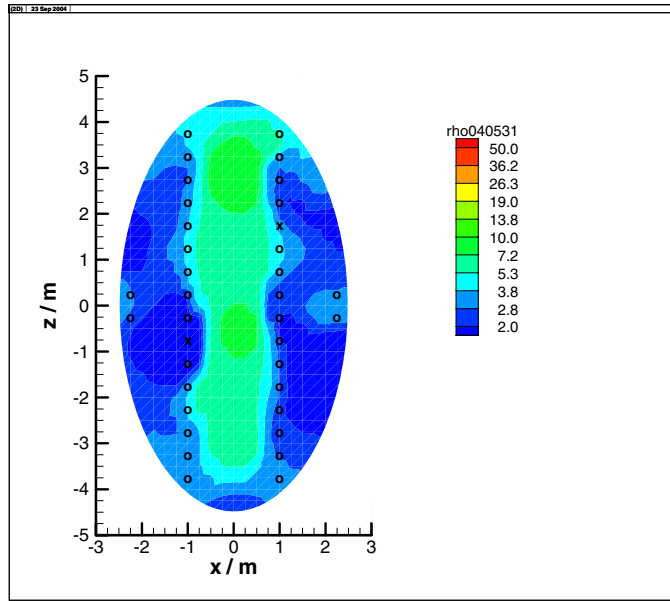

2004-05-31

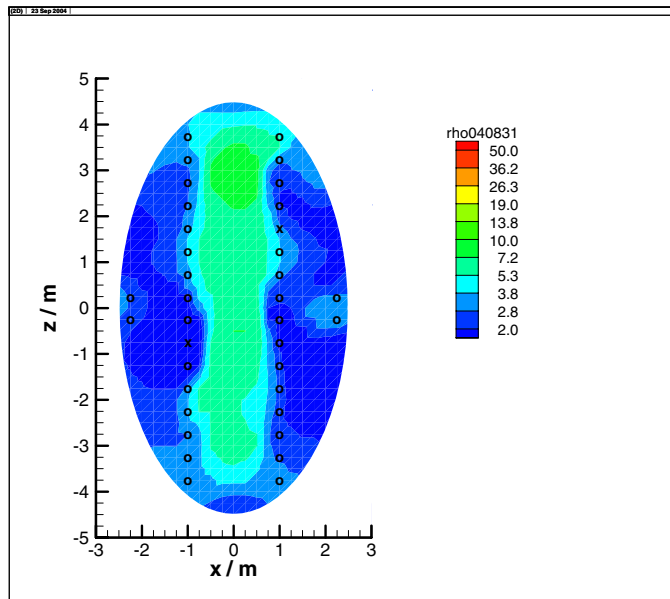

2004-08-31

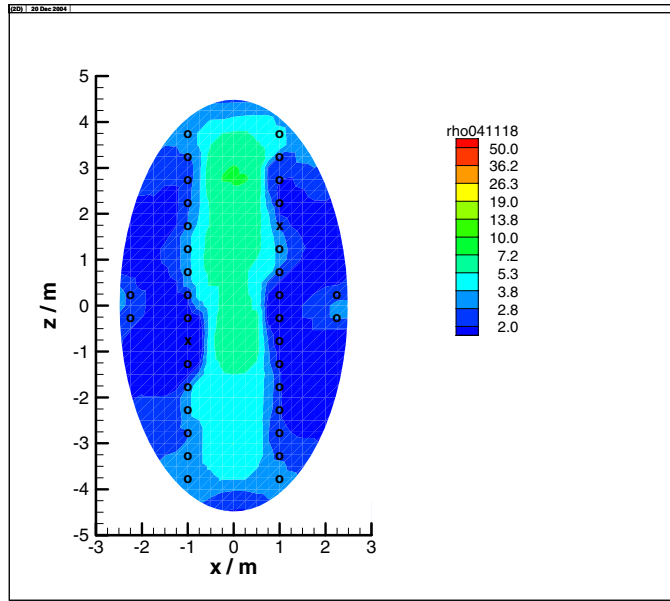

2004-11-18

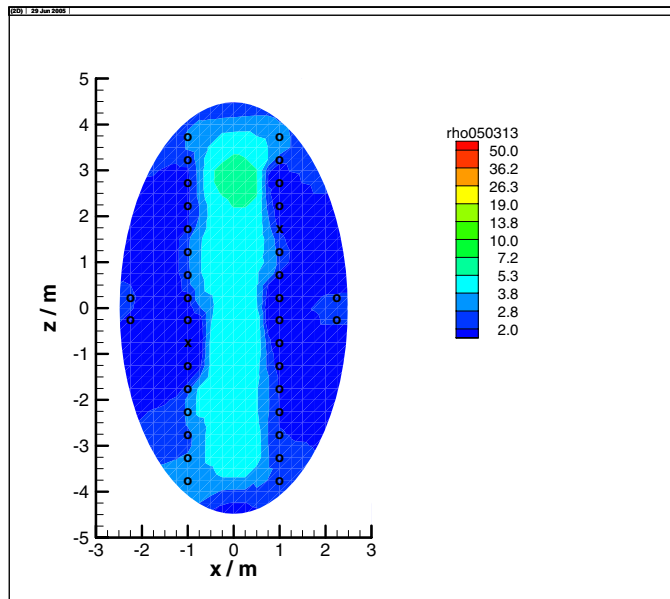

2005-03-13

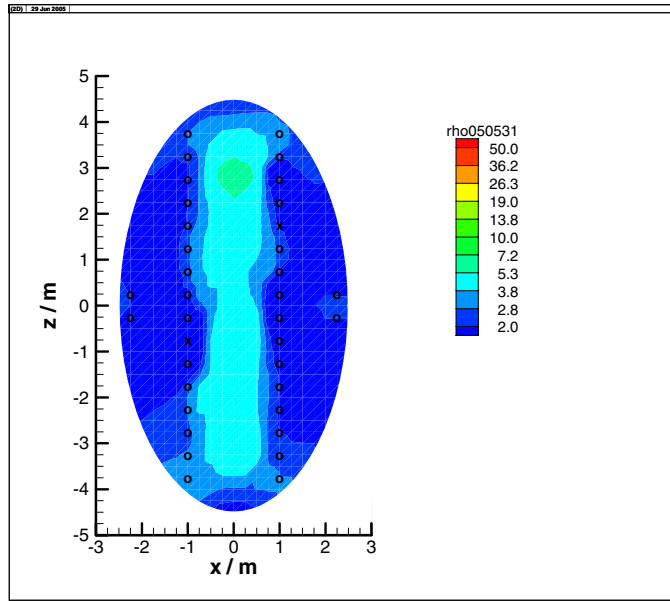

2005-05-31

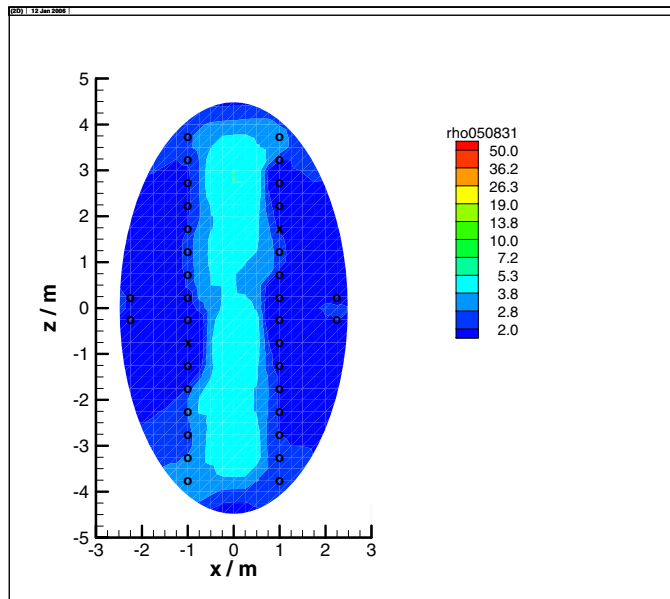

2005-08-13

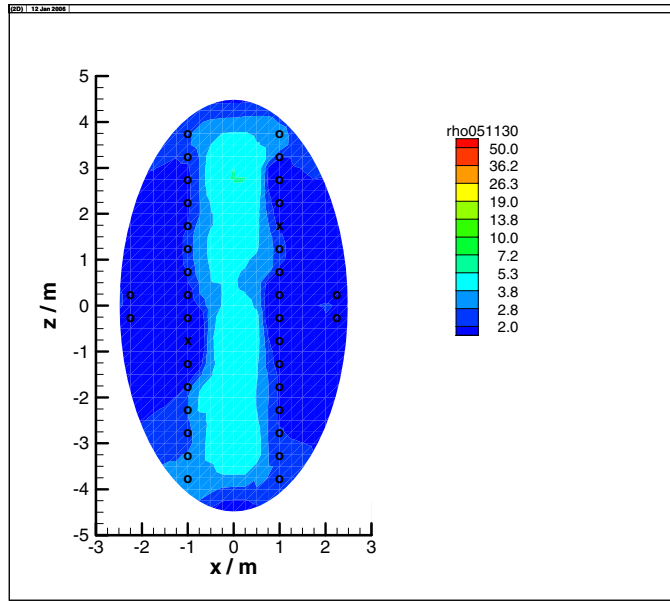

2005-11-30

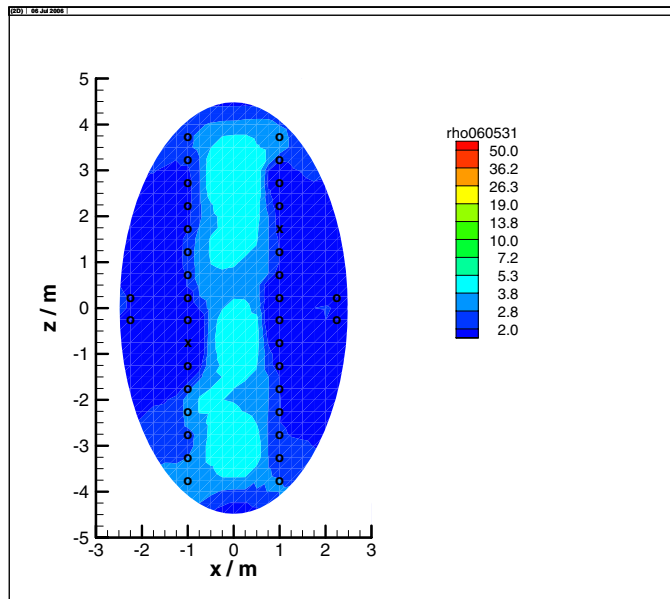

2006-05-31

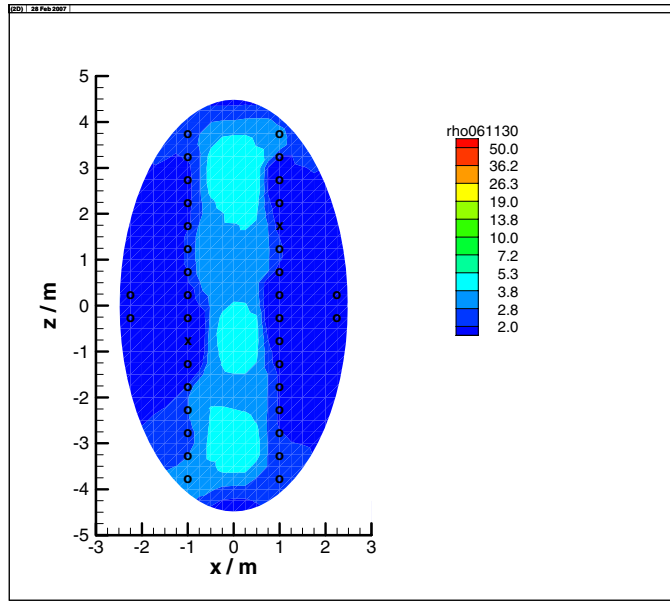

2006-11-30

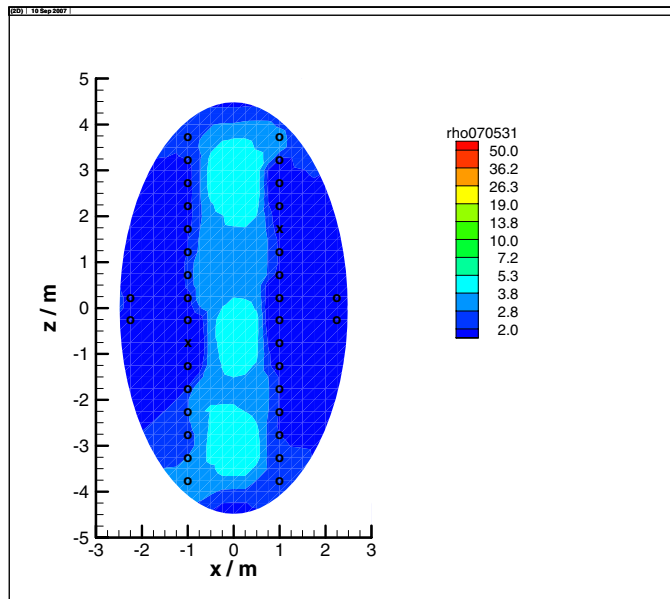

2007-05-31

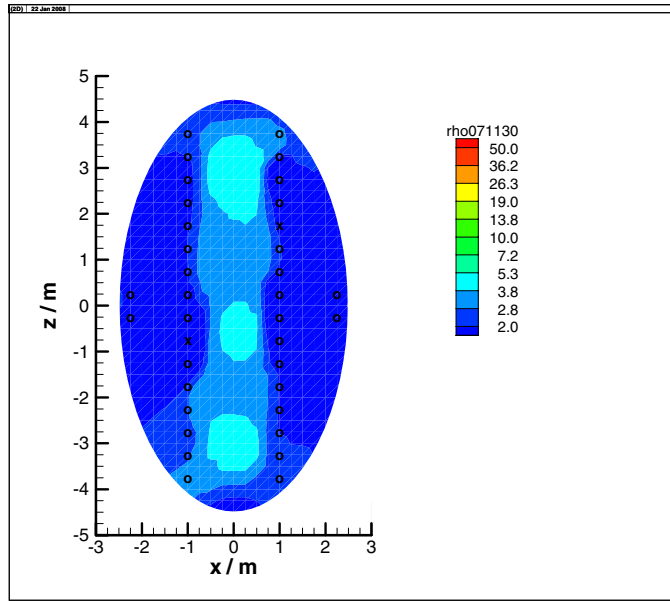

2007-11-30

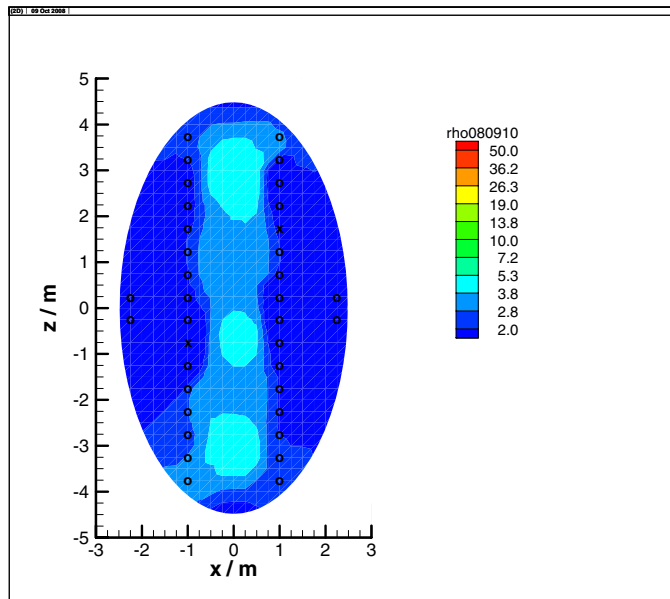

2008-09-10

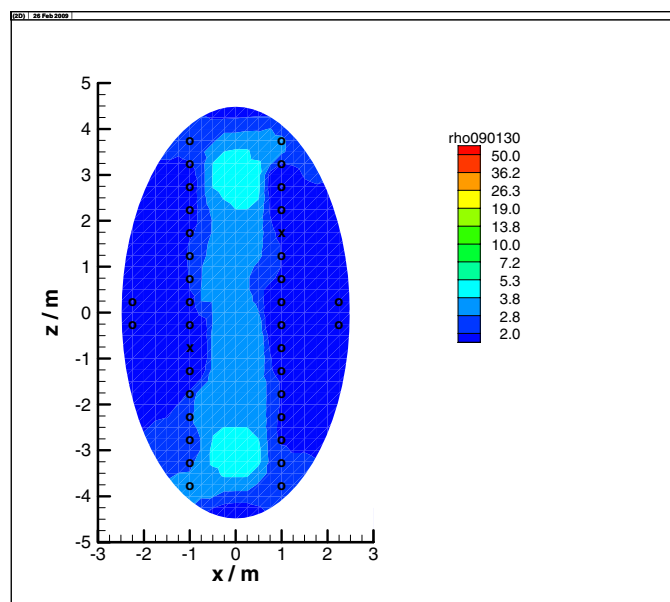

2009-01-30

3.3 Actual Interpretation

The first measurement performed on June 18, 2003 in section 2 shows a much lower resistivity than the early measurements in section 1. Obviously, the backfill had a considerably higher water content already during installation. This observation was also made during instrumentation. Resistivity is decreasing further from the drift walls. Close to the walls it ranges below $3 \Omega\text{m}$; the backfill is therefore not far from full saturation. In the centre resistivity has decreased to values around $3 \Omega\text{m}$ corresponding to a water content of 21 to 22%. The central area of higher resistivity has been continuously decreasing in size until now. In particular, the surprising evolution encountered in section I has not been found here.

4 Rock Section 2

4.1 Layout of electrode array in the rock between deposition boreholes 5 and 6

A) Vertical cross section

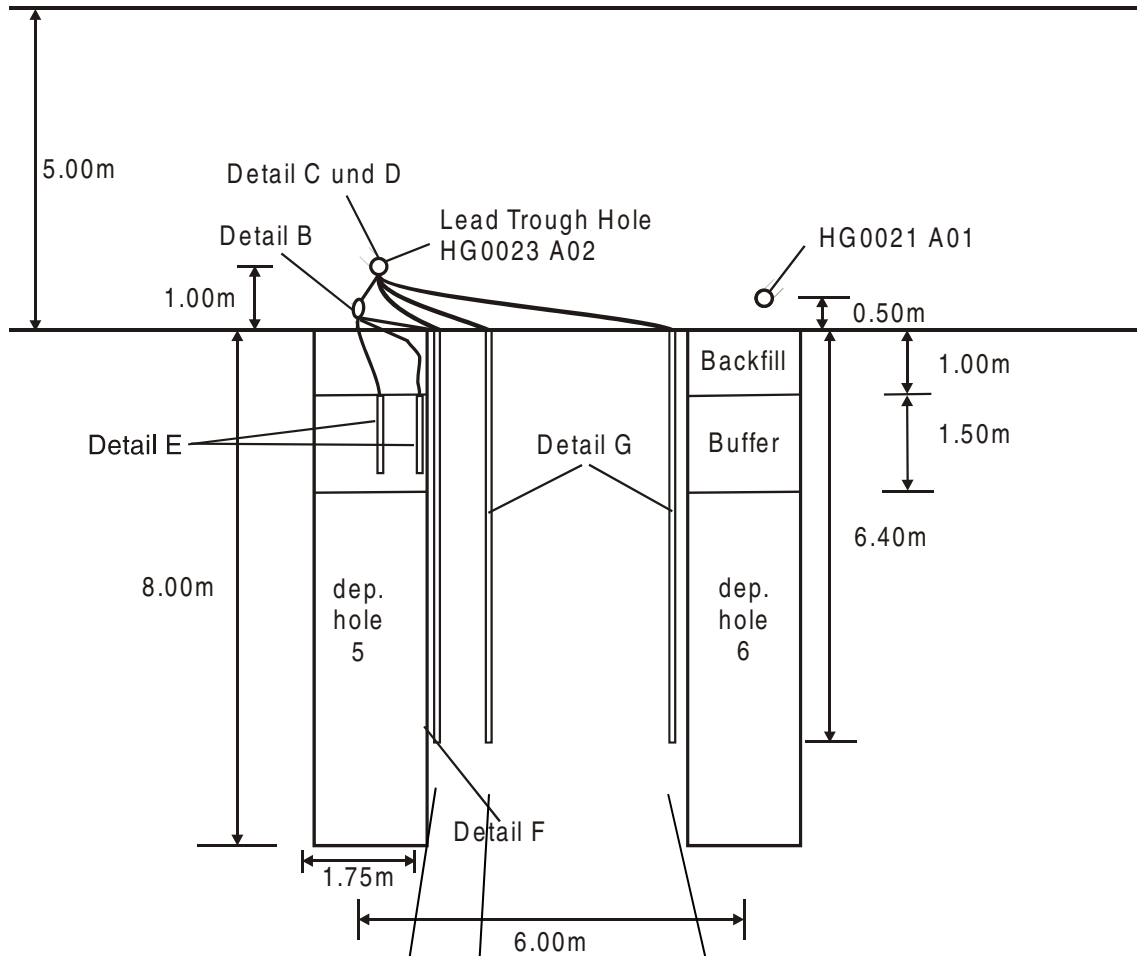

B) Plan view

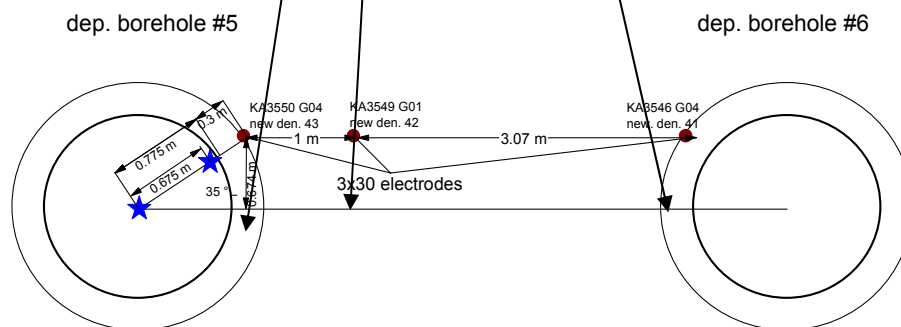

4.2 Tomograms of electrode arrays in the rock

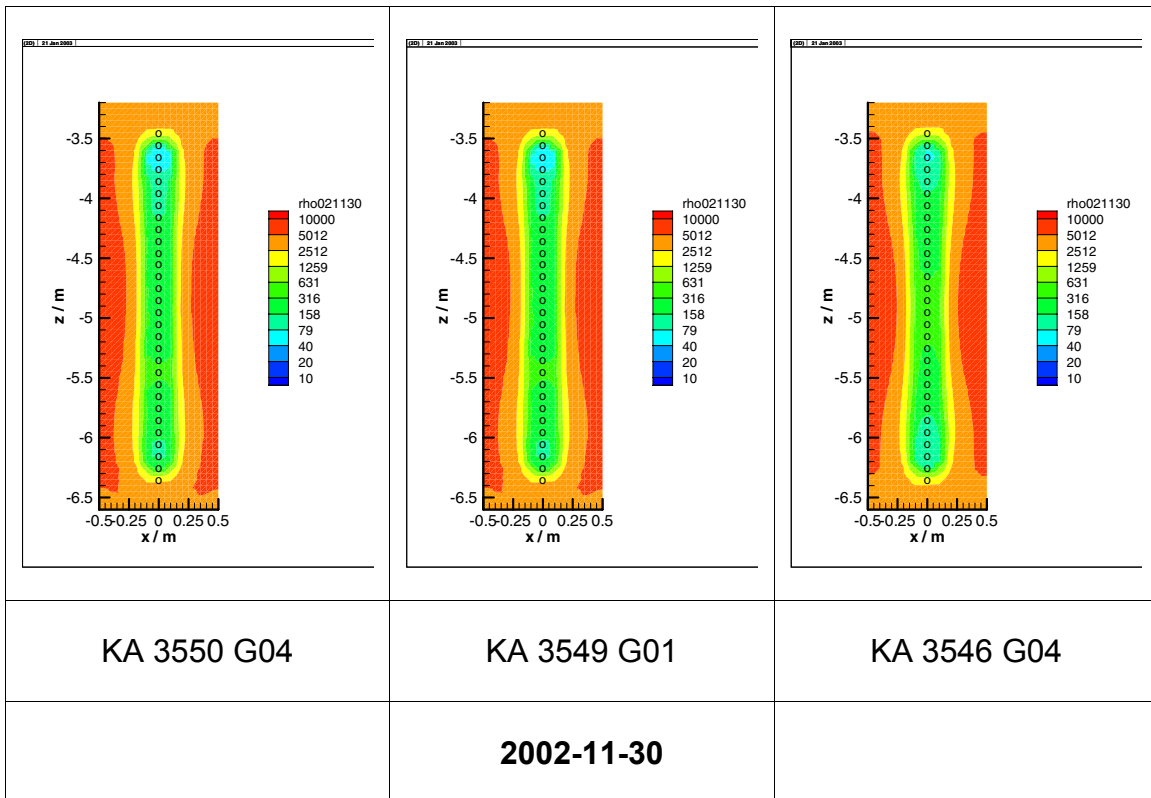
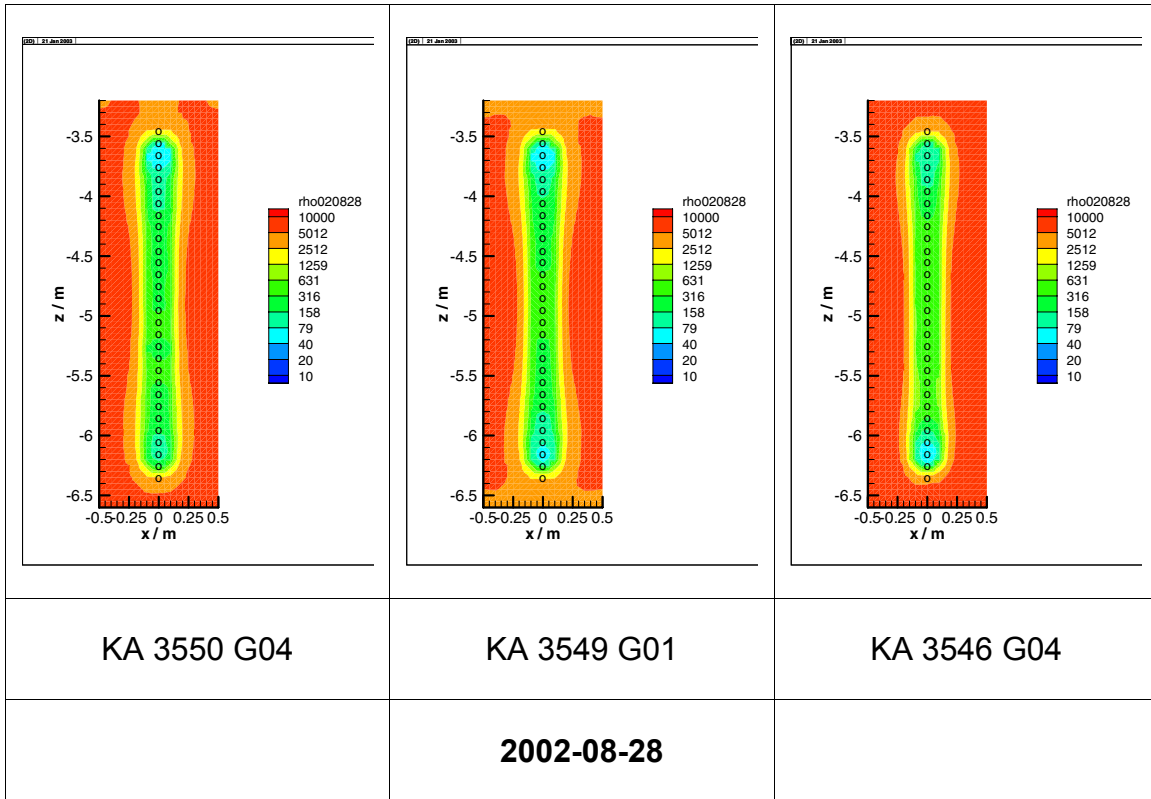

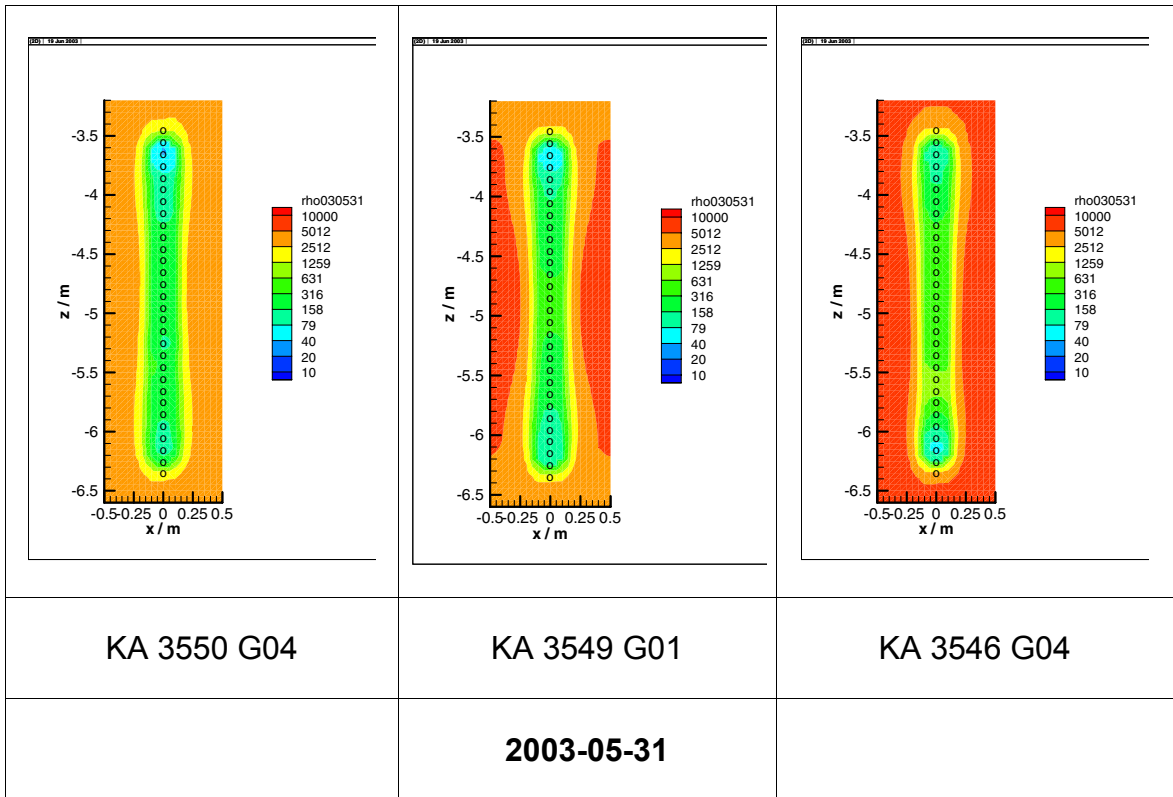
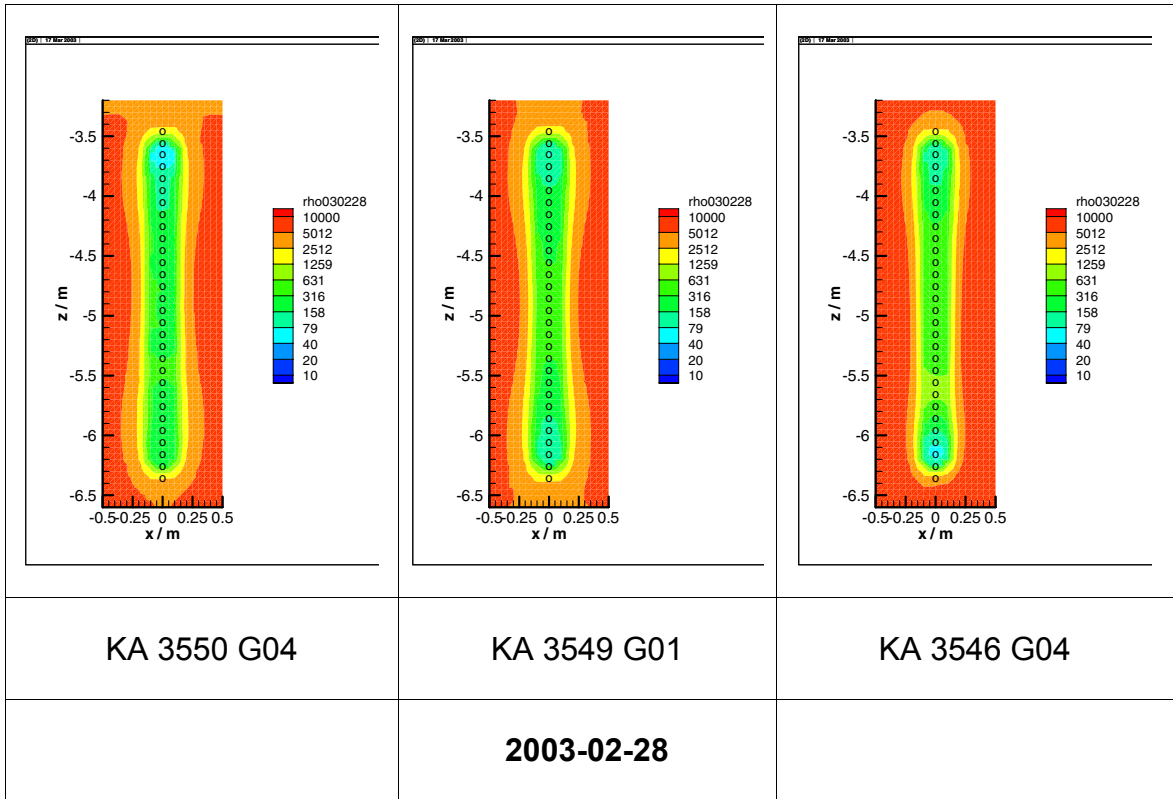

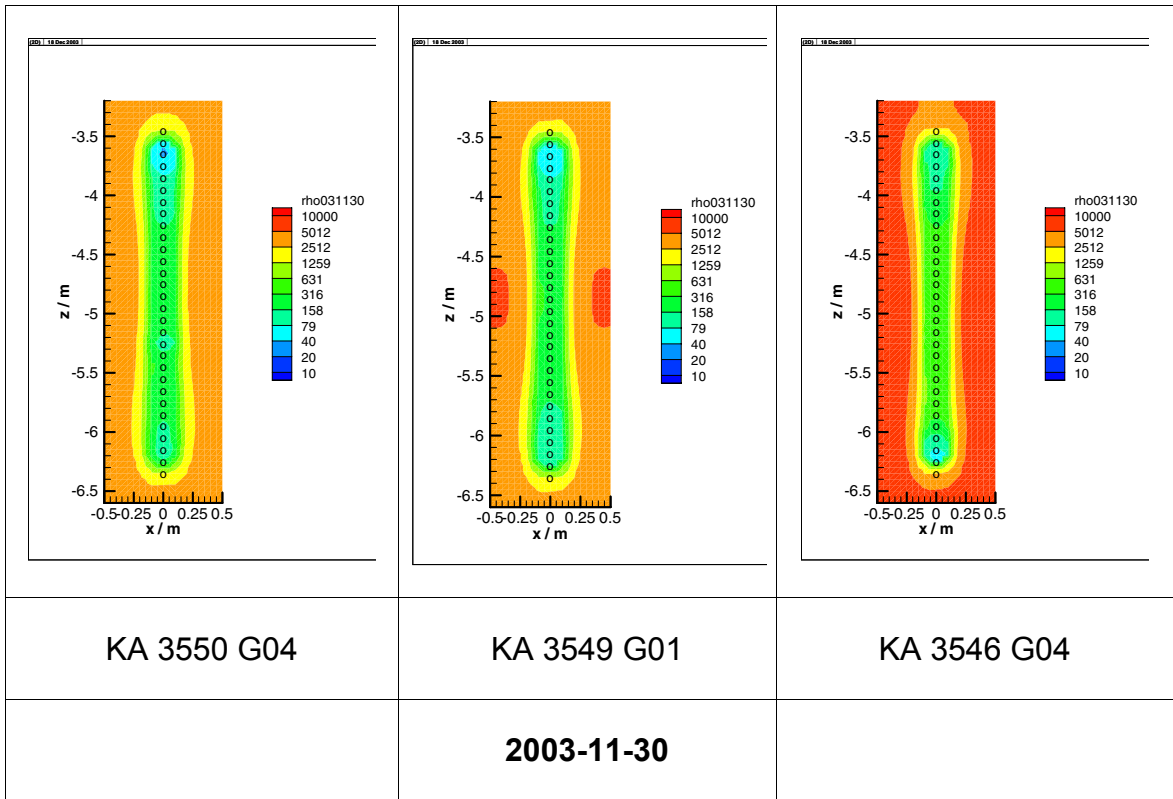
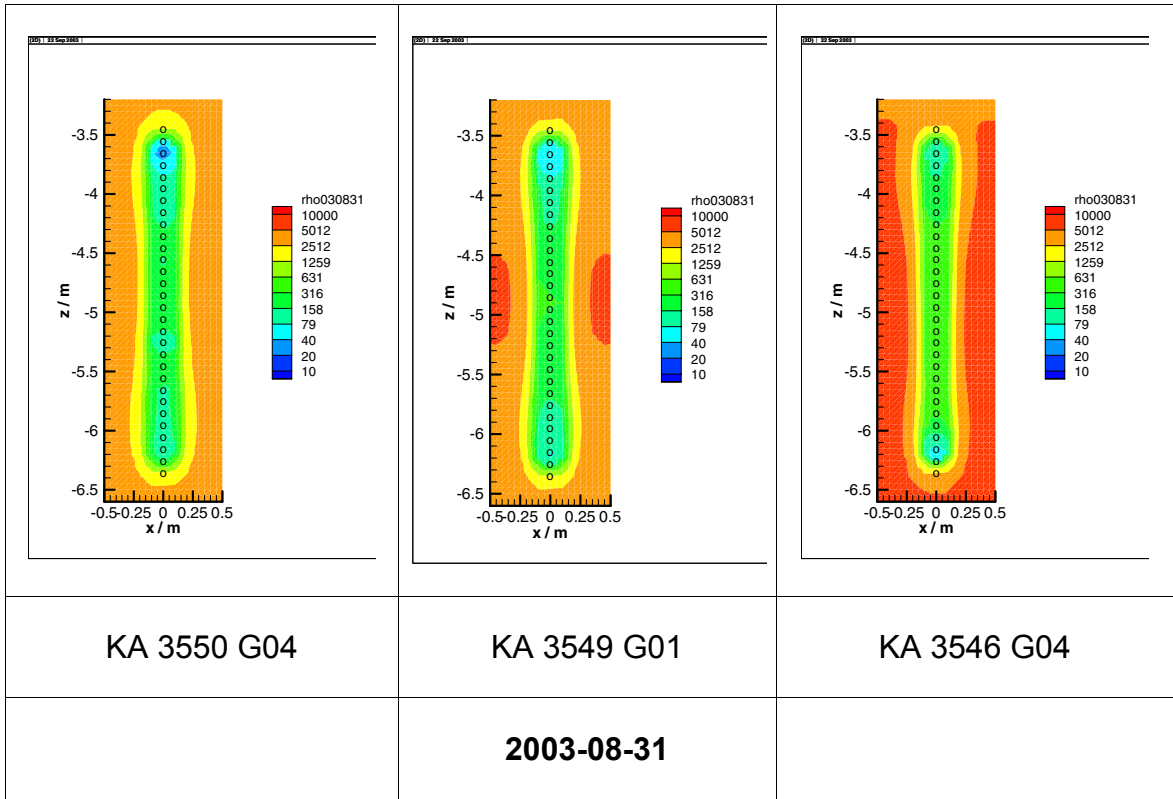

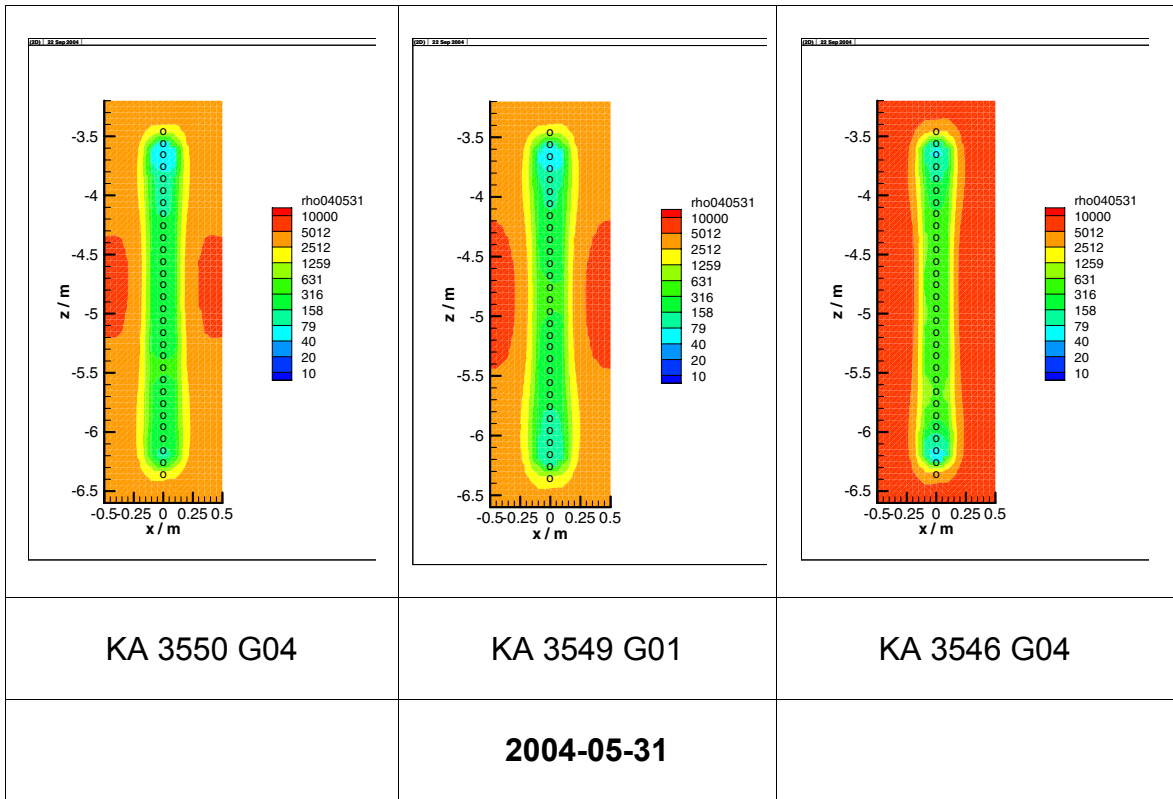
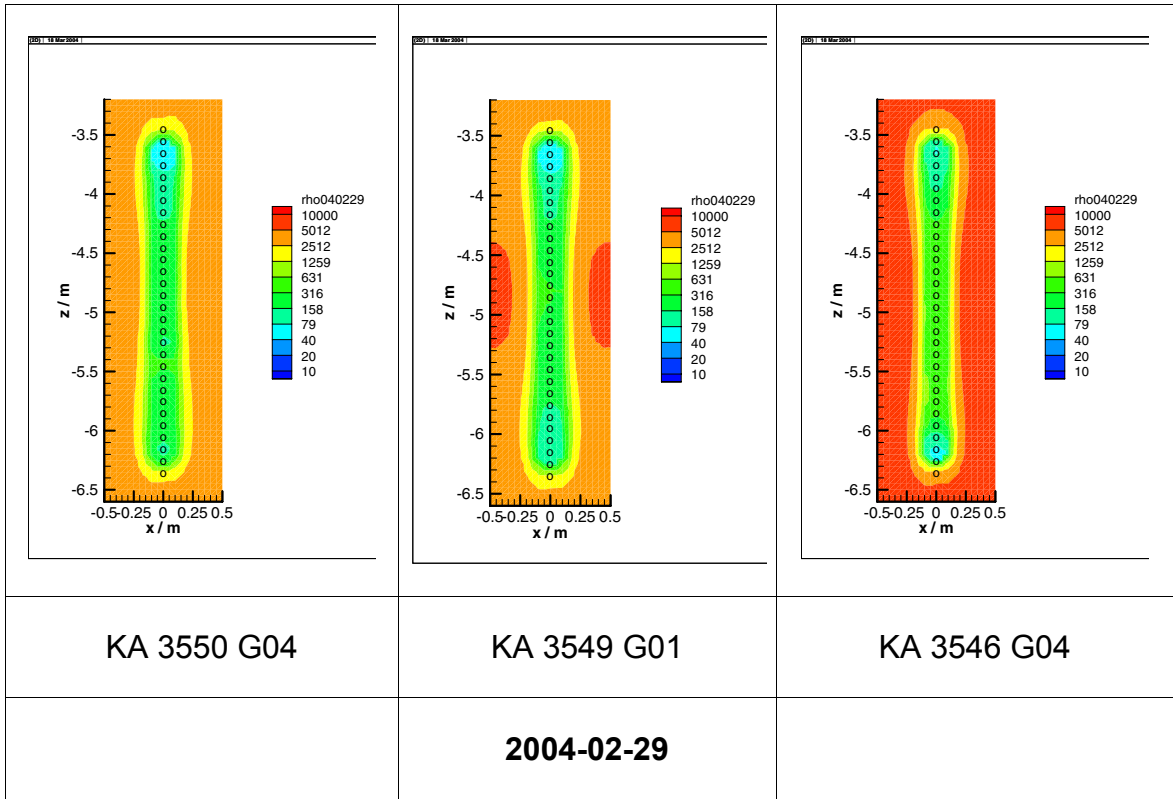

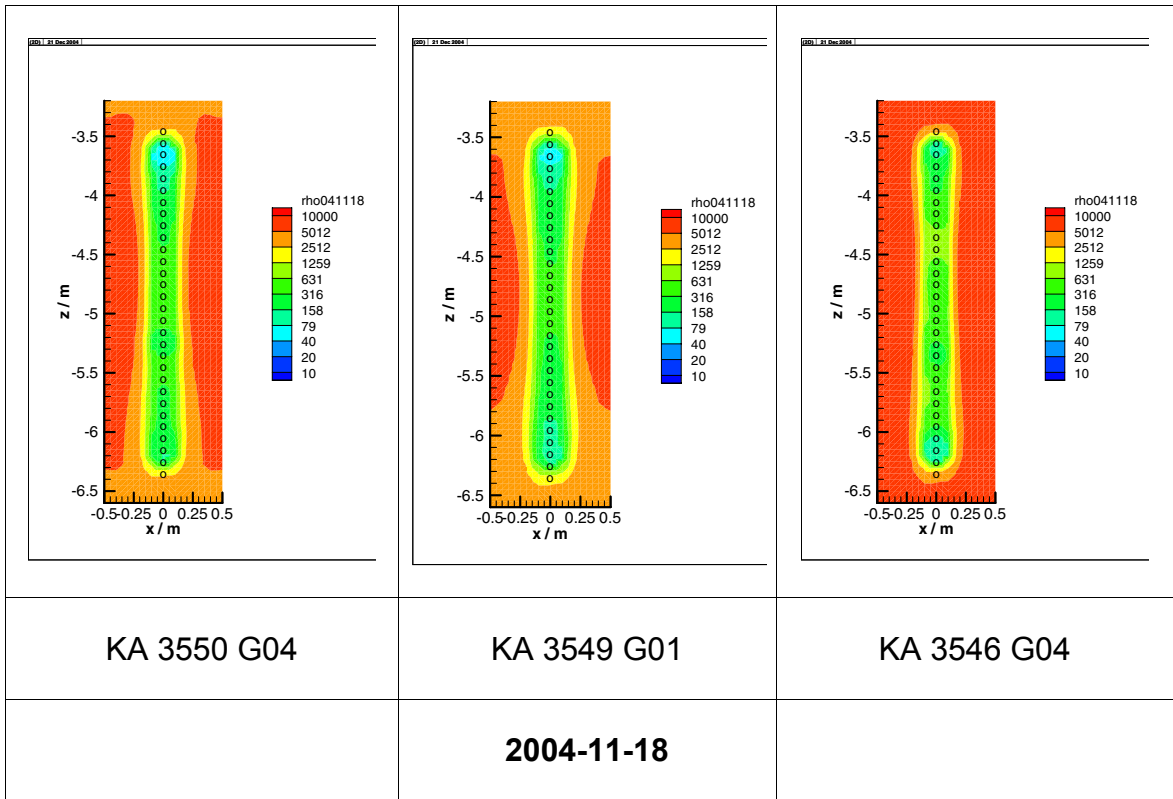
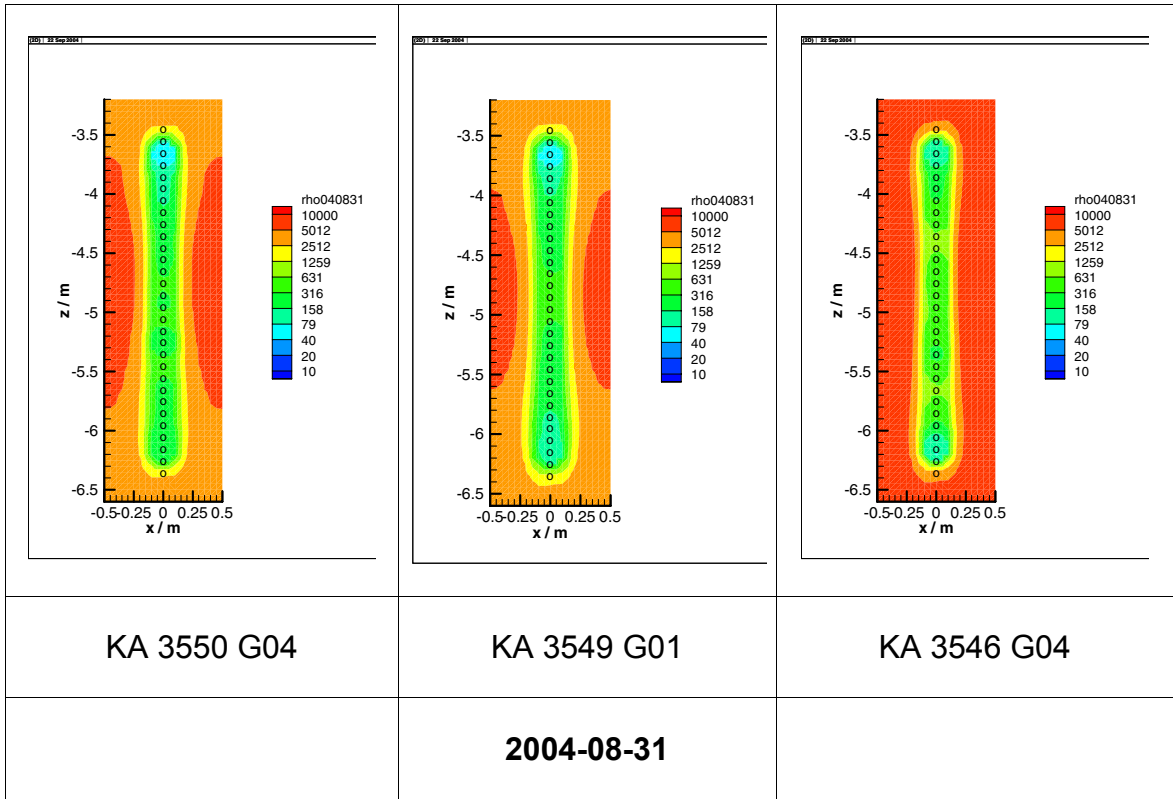

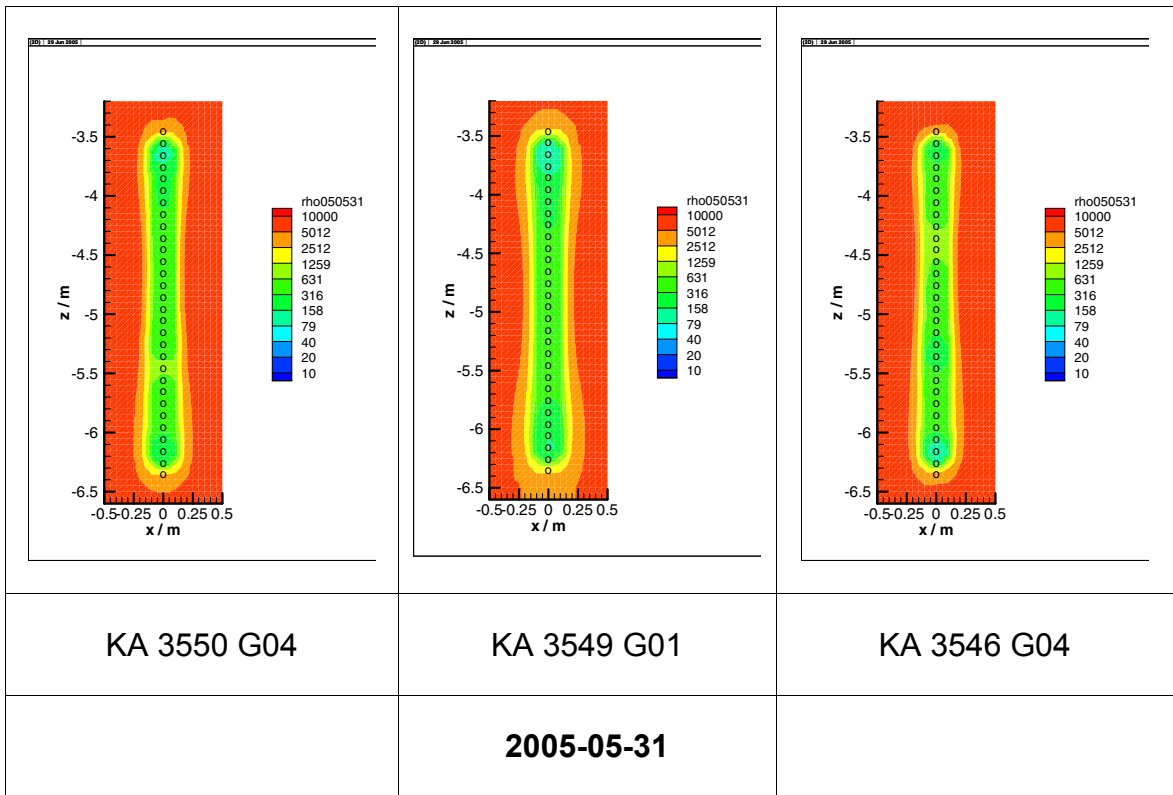
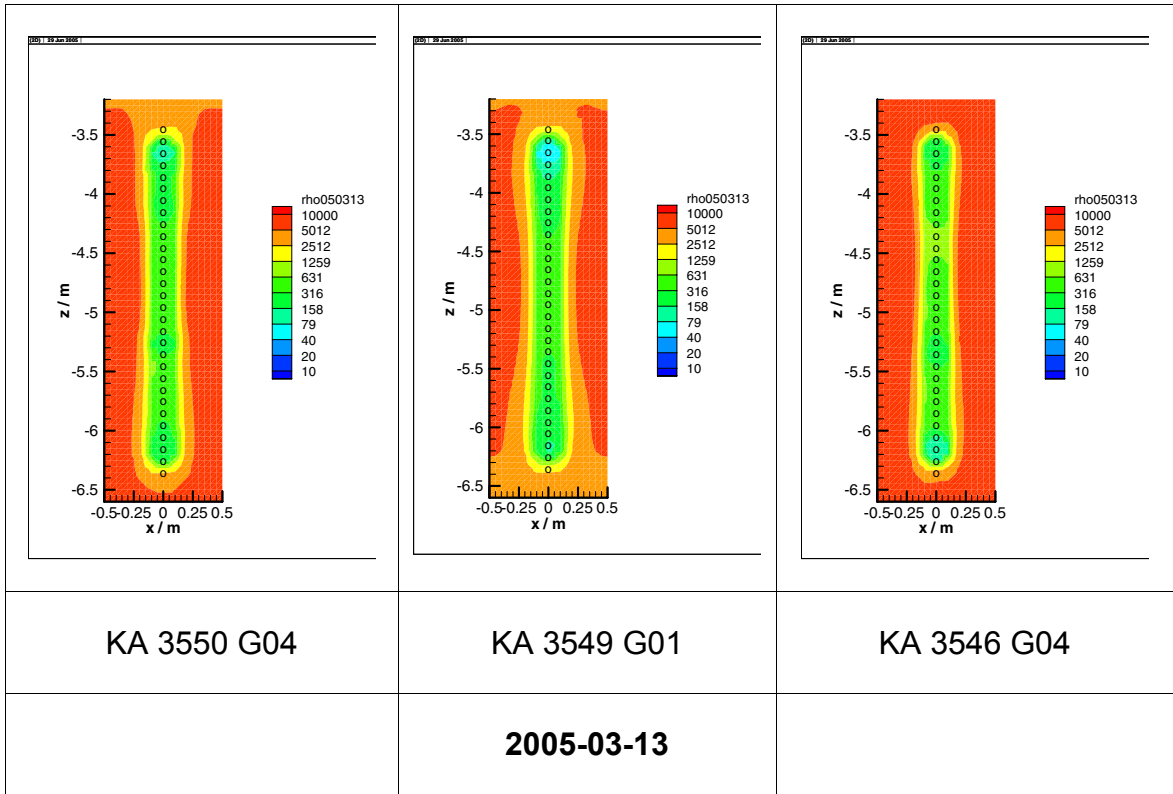

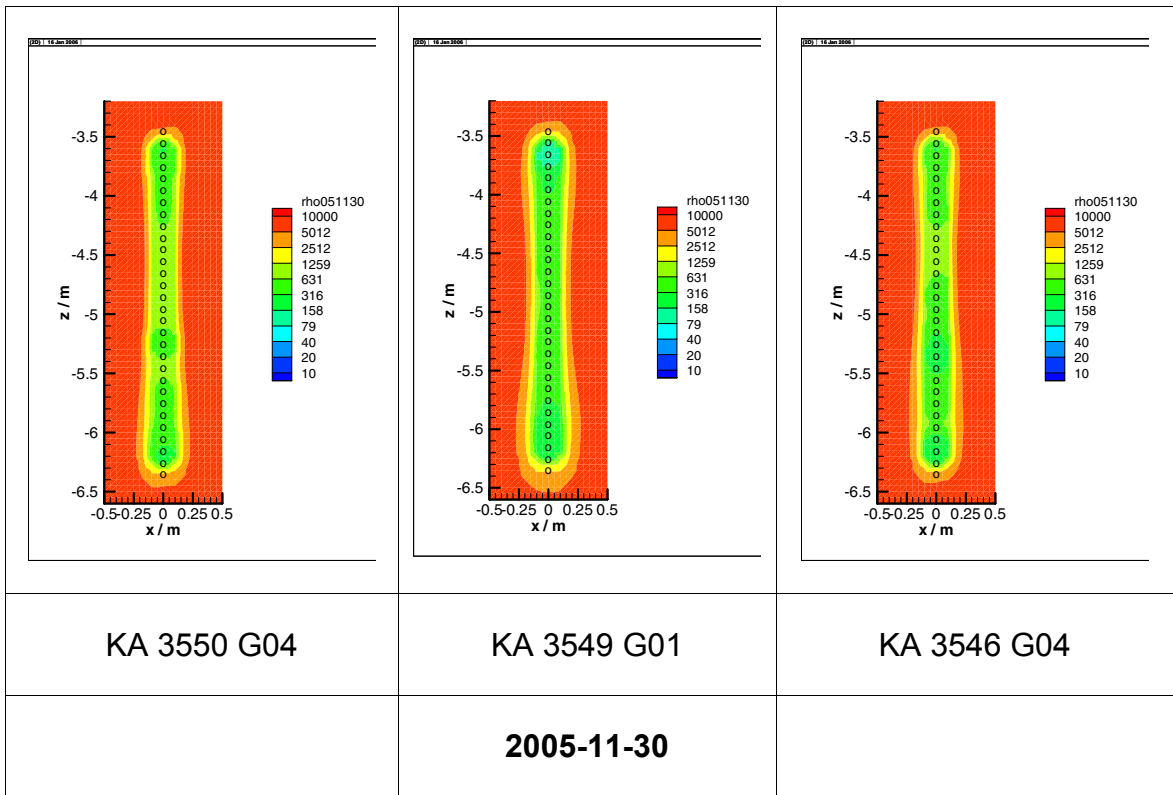
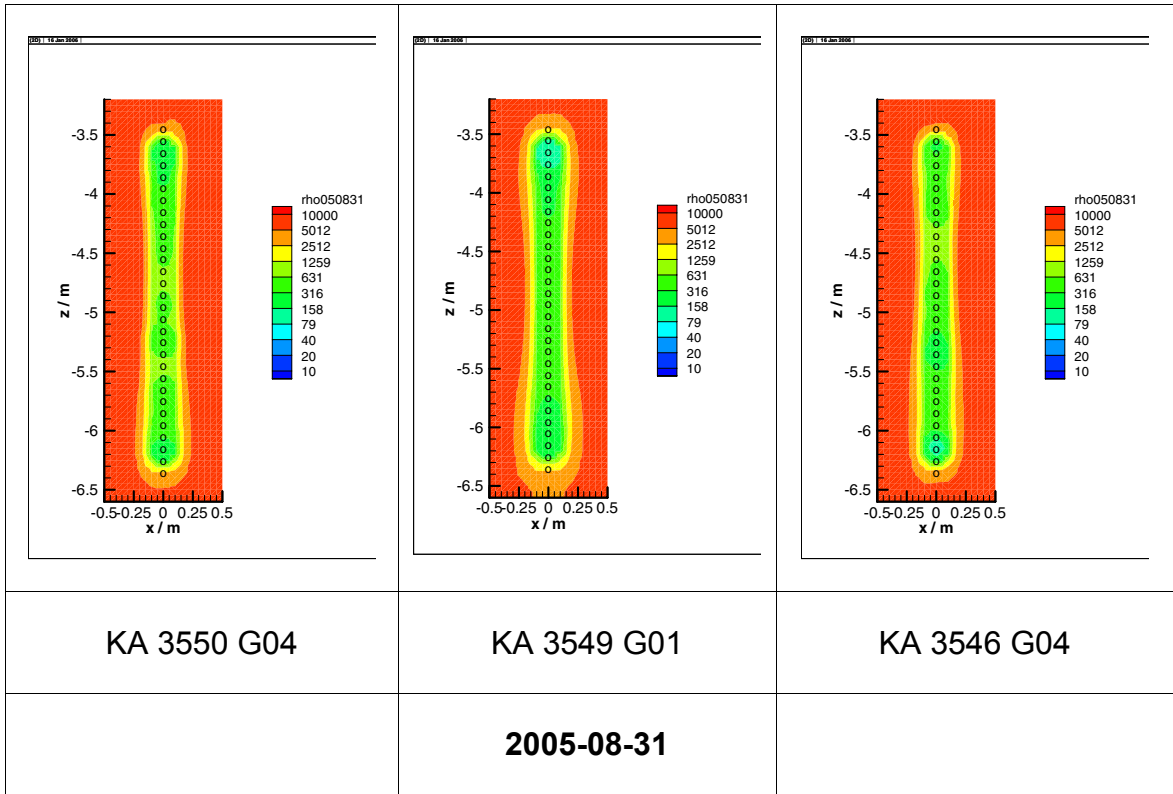

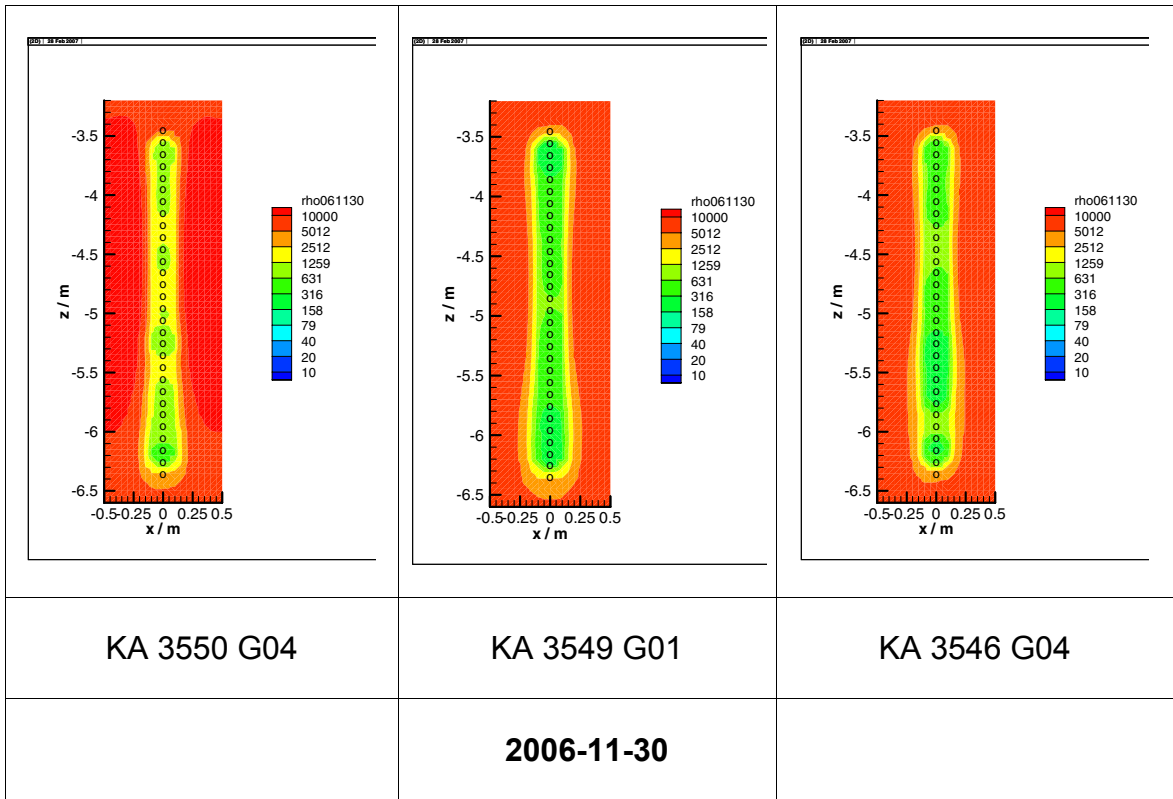
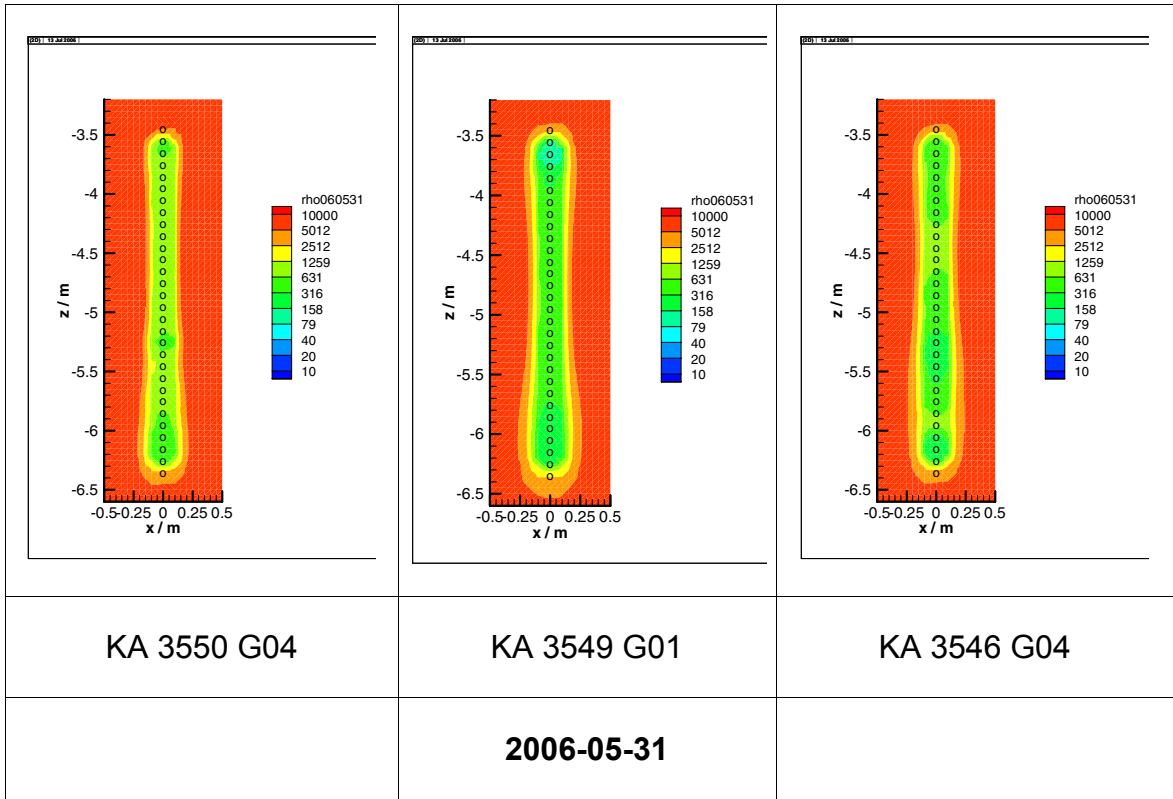

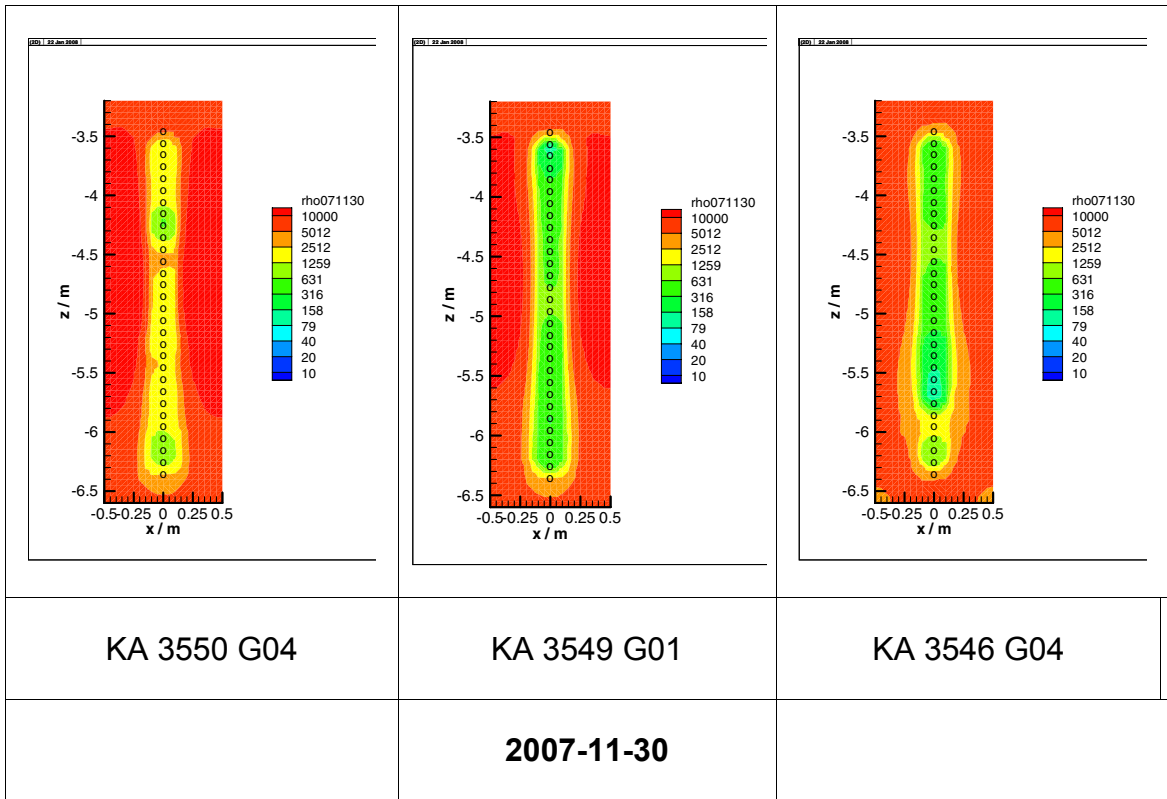
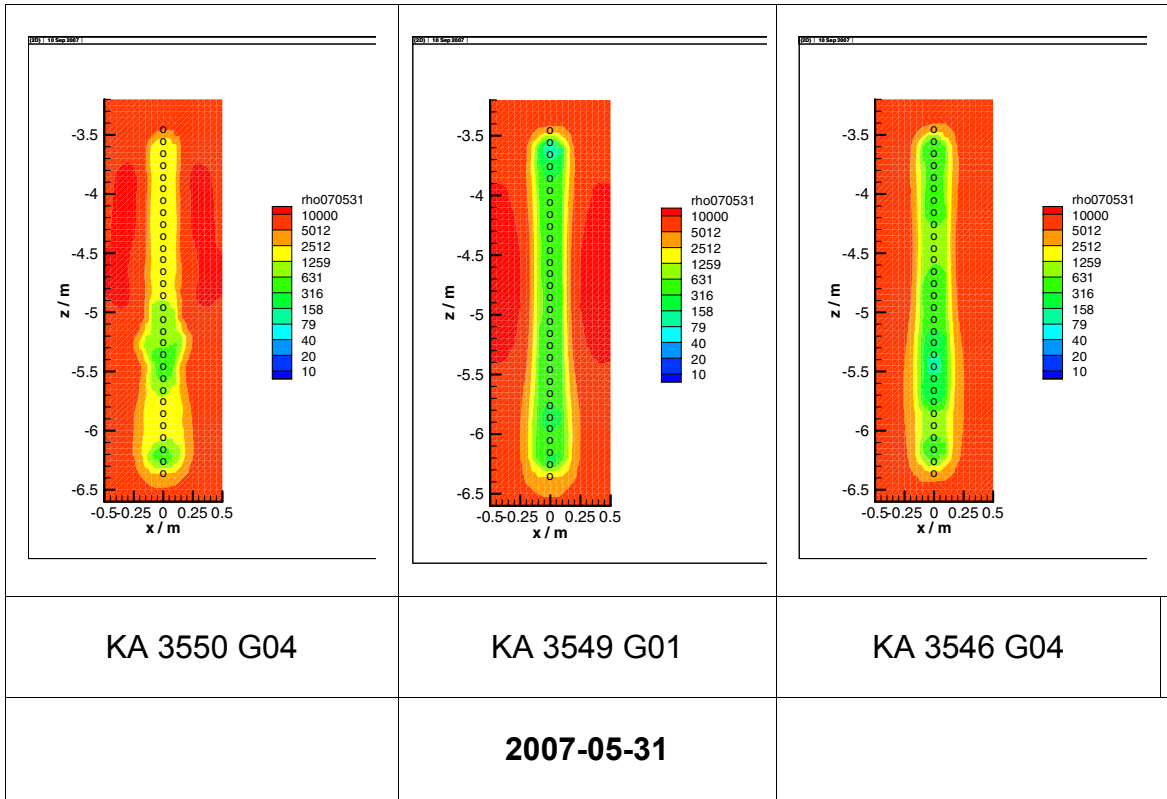

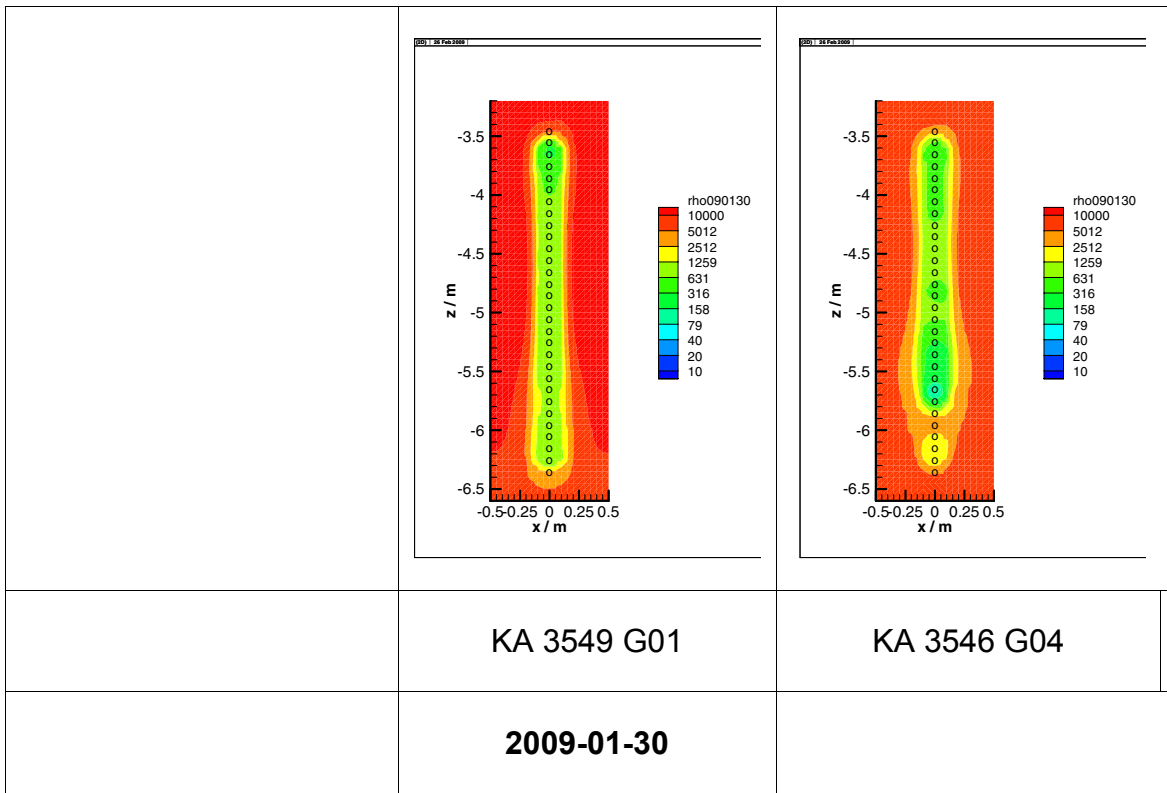
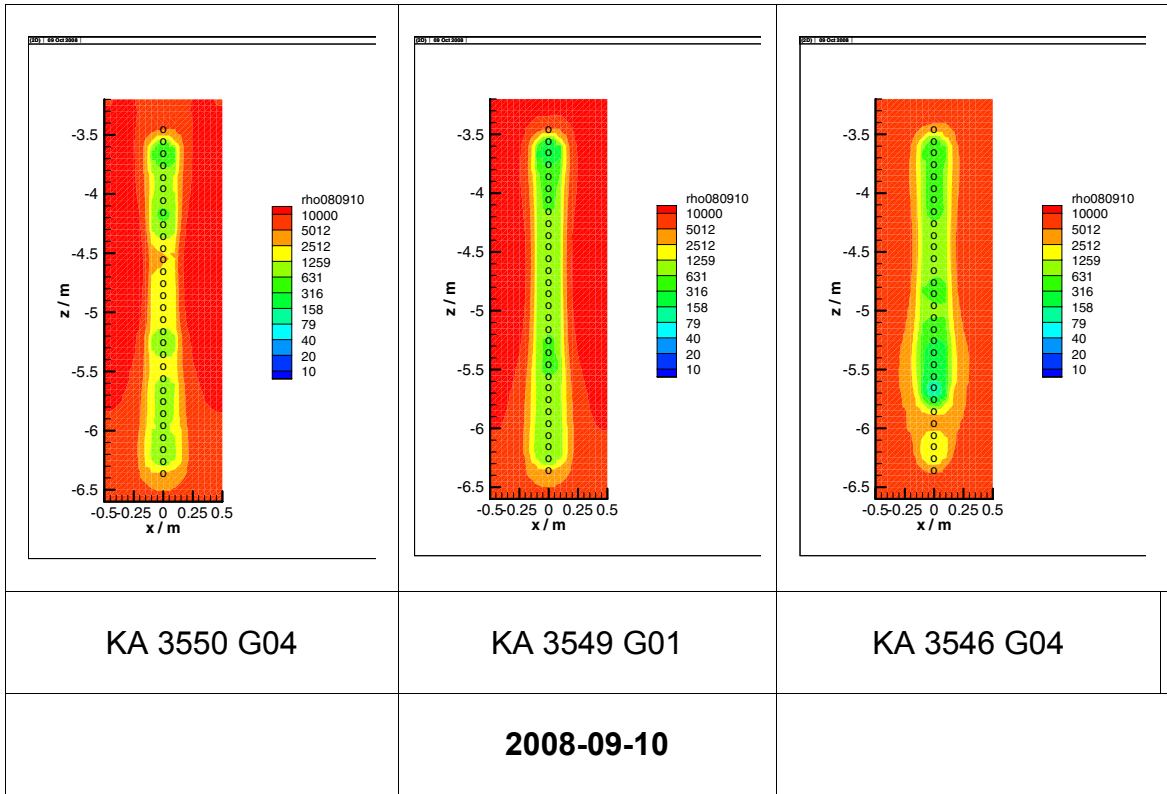

4.3 Actual Interpretation

The resistivity distributions along the three electrode chains installed in the rock are quite similar to each other and show no significant variation in time until April 2003. Close to the electrodes, the resistivity ranges around 200 Ωm . This value characterizes the water-saturated concrete used for backfilling the electrode boreholes. Further away from the boreholes, the resistivity rises to values of 2000 to 7000 Ωm which is characteristic for water-saturated granite.

From April 2003 on, there is a slight decrease in resistivity in the rock near deposition hole #5. This coincides with installation of the buffer which also stopped the pumping of water from the open deposition hole. Apparently, this had caused a slight desaturation of the rock which recovered. From February 2004, resistivity seems to increase again. This becomes very visible from May 2006 on and might be caused by a drying of the concrete backfill of the electrode hole and possibly of the surrounding rock. Near the deposition hole #6, no such effect was detected.

At the end of 2008, the complete electrode chain near deposition hole #5 failed, probably due to a cable failure. Therefore, no tomogram of January 2009 is shown for this chain.

5 Buffer in Borehole 5 in Section 2

5.1 Layout of electrode array in the buffer of deposition boreholes 5

The array is made up of the electrodes located in the buffer at the top of deposition hole #5 (see figure) and of the electrodes in the upper part of borehole KA 3550 G04 in the rock (see figure in section 4.1).

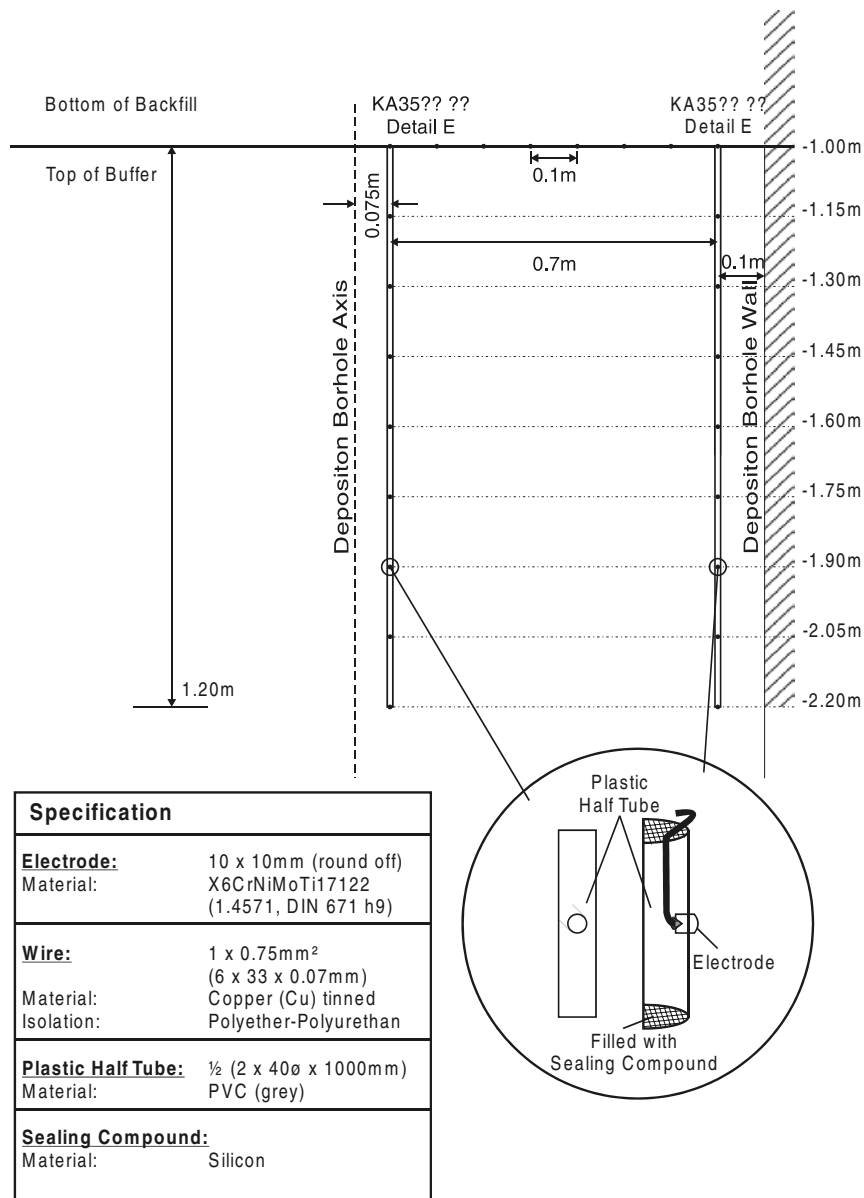

ELECTRODE DETAIL E VERS 01.CDR

5.2 Tomograms of electrode array in the buffer

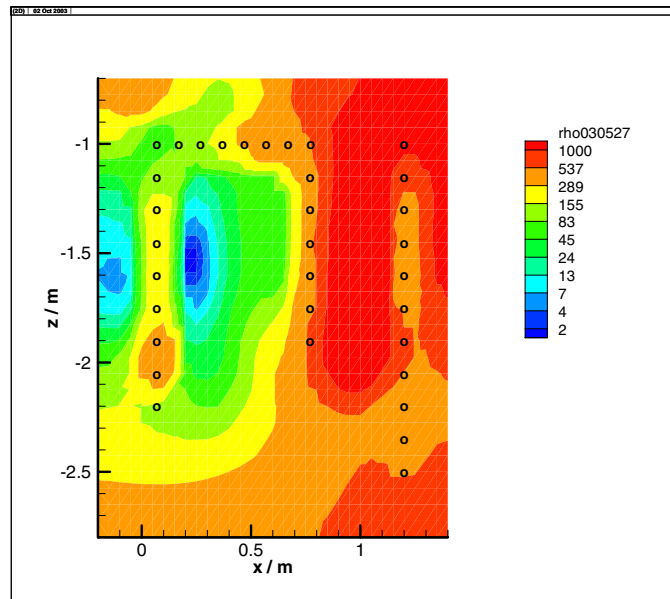

2003-05-27

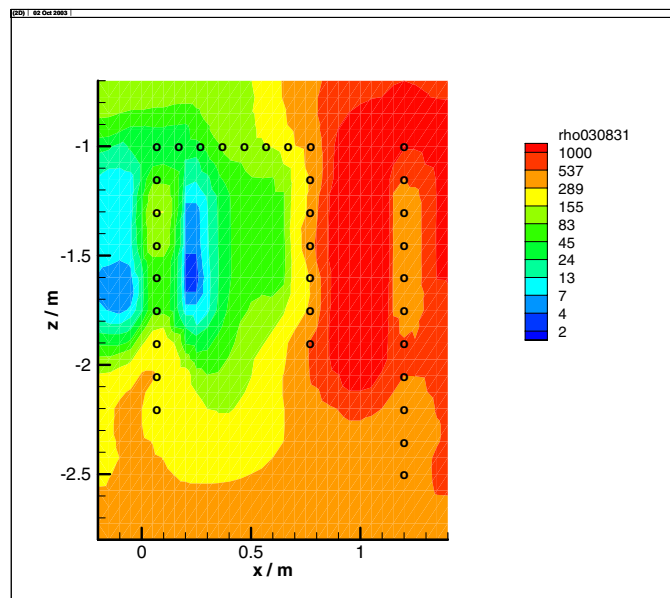

2003-08-31

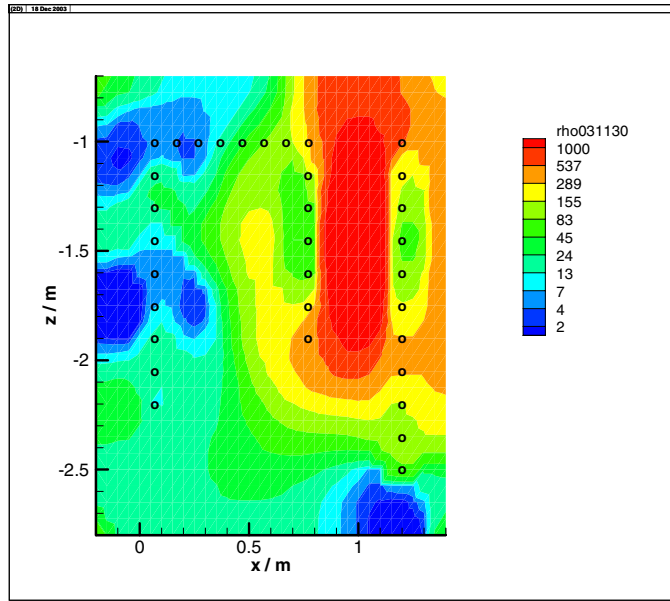

2003-11-30

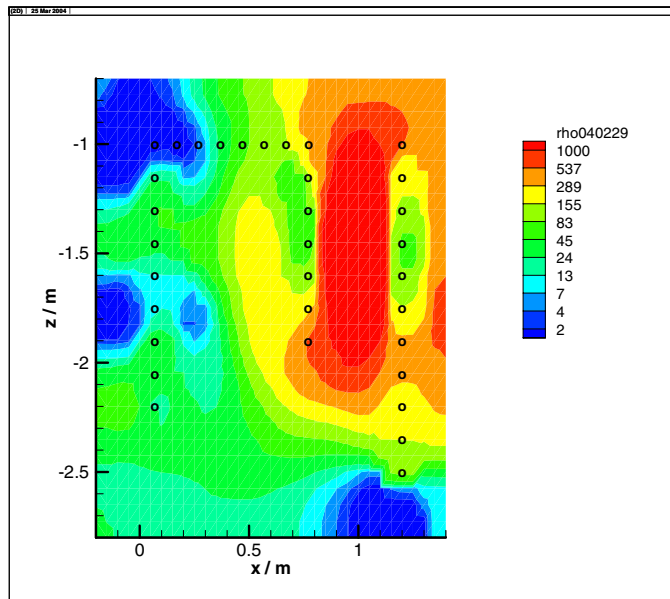

2004-02-29

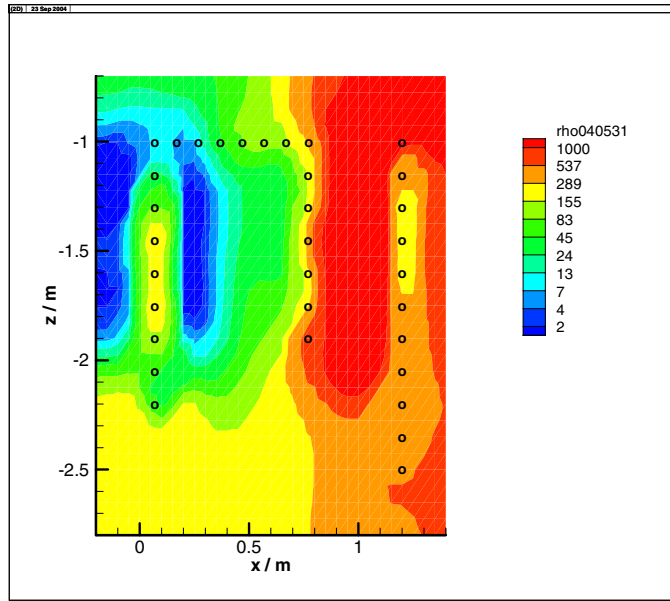

2004-05-31

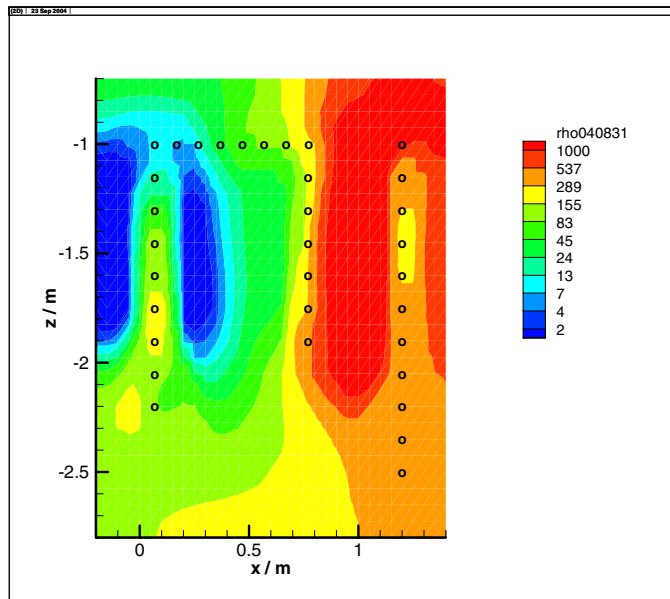

2004-08-31

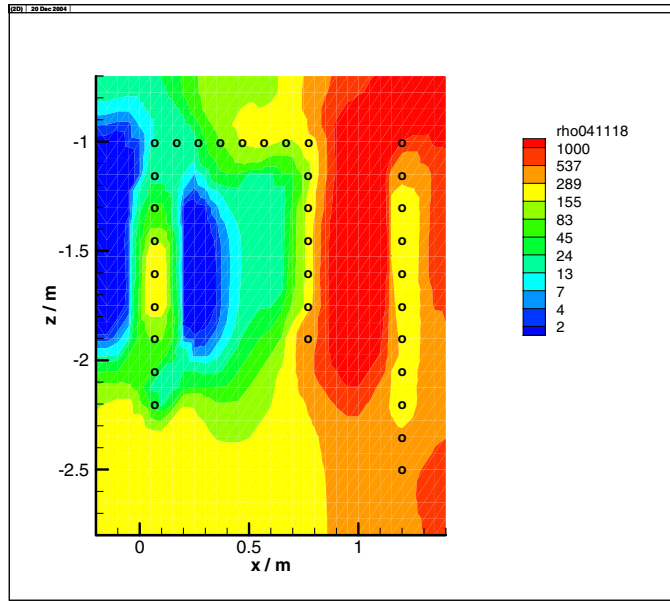

2004-11-18

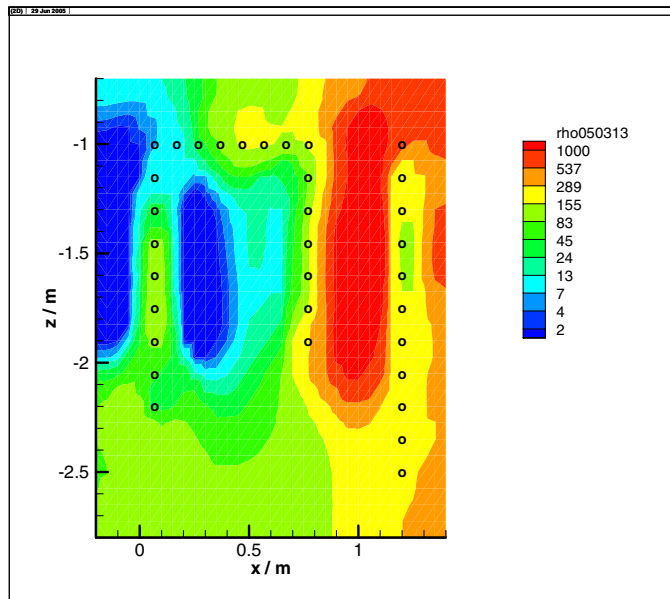

2005-03-13

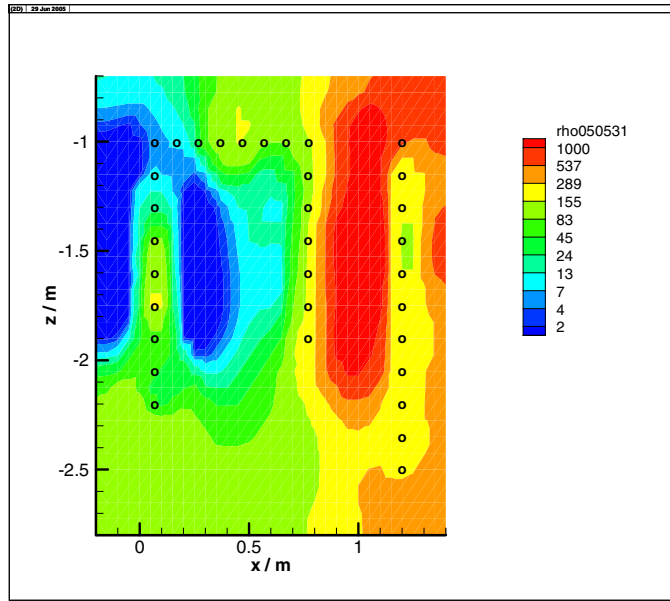

2005-05-31

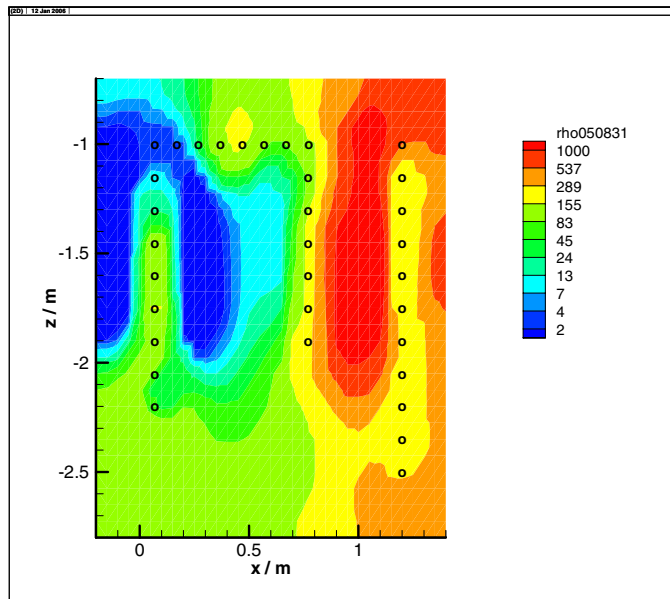

2005-08-31

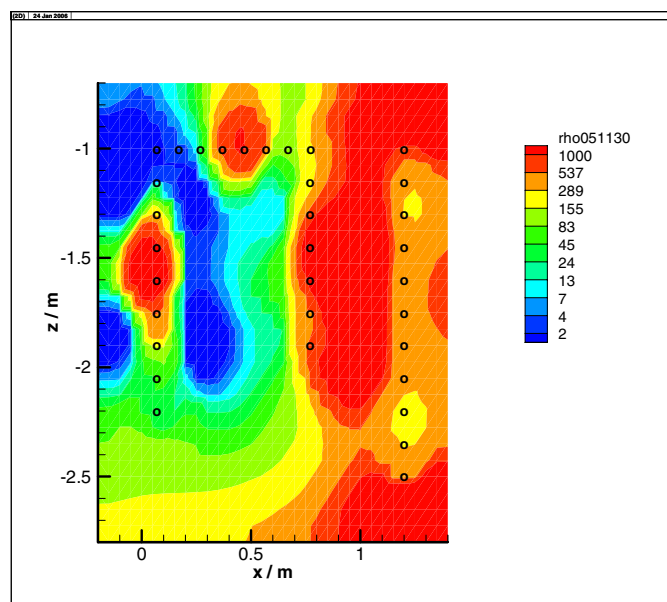

2005-11-30

5.3 Actual Interpretation

The tomogram of May 2003 (first measurement) shows the high resistivity (above 1000 Ωm) of the rock on the right side and the low resistivity of the buffer (below 80 Ωm). The picture is somewhat distorted by the fact that along the electrode chains the resistivity is increased compared to the undisturbed buffer. The increased resistivity along the electrode chains can be attributed to the refilling of the electrode boreholes with bentonite powder produced during borehole drilling. It was, however, expected that the difference would diminish with time, especially if the buffer takes up water. The tomograms of the following months show a progressing decrease of resistivity in the buffer. While the overall behaviour is rather clear, it is difficult to interpret buffer resistivity in terms of water content. In nearly all the buffer monitored by the array the resistivity has decreased to values below 24 Ωm by November 2004 and below 13 Ωm by end of May 2005. The tomogram of November 2005 shows two high resistivity anomalies in the buffer. These are not real, but result from the fact that two electrodes have been lost between September and November, 2005. The accuracy of the results is reduced by the loss of electrodes. From November 2005 on, more electrodes failed (possibly due to corrosion) so that a tomographic evaluation was no longer possible. The injection current of the electrode pairs which are still working is still increasing, which is a hint to a further decrease in resistivity, meaning the buffer is still taking up water.

Appendix 10

Stress and strain in the rock

BBK

STRESS AND STRAIN MEASUREMENT OF THE ROCK MASS PROTOTYPE TEST AT ÄSPÖ

Measuring period

2008-06-01 – 2008-11-30

Johan Aasma

Kennert Röshoff

2009-04-20

ÅF Infrastruktur, Frösundaleden 2a, Solna SE-169 99 Stockholm, Sweden

Tel switchboard. 010-505 00 00 Fax. 08-650 58 77

1 Extent

BBK AB and NCC Teknik have, on commission of SKB, ÄSPÖ Hard Rock Laboratory, performed rock mechanical measurements in the Prototype tunnel at Äspö. The measurement program comprises registration of the stress and strain response around the two deposition holes during drilling and heating of the rock mass.

In the first phase, the response of the rock mass was monitored during the drilling of the two canister holes. The second phase, which is the subject of this report, includes the response registered during a heating phase. The heating experiment started on 2003-05-08 and will continue for about five years.

The goal of the instrumentation is to monitor the stress, strain and deformation changes due to heating of the rock mass surrounding the deposition holes. Instrumentation has been installed to monitor the relative changes in intact rock as well as across fractures.

The commission extends over field measurement and evaluation.

BBK AB is responsible for measuring equipment, the mobilization, field measurement, the computer processing. BBK AB and NCC Teknik are responsible for the interpretation and reporting of the measurements.

This report presents the measurement results during the period of the heating phase from 2008-06-01 to 2008-11-31.

2 Technical background

2.1 Summary of instruments installed

The instrumentation for monitoring rock mechanical response was installed in two stages. The instruments used to monitor the drilling phase of the canister boreholes were installed within vertically drilled boreholes located 0.3m from the periphery of the deposition hole. These instruments are referred to as primary instruments in the following section. Following drilling of the deposition holes, complementary instruments were then installed within boreholes drilled from within the deposition holes.

The following numbers and types of instruments were selected for installation to allow monitoring of stresses and strains within the host rock surrounding the deposition holes.

Table 2.1. Summary of primary instruments.

Parameter measured	Instrument type	Total number installed
Compressive stress change in intact rock	Geokon model 4350 biaxial stressmeter	8
Compressive and tensile stress change in intact rock	Geokon model 4360-1 Soft stress cell	8
Vertical movements in intact rock, over single fractures and within fracture zones	Geokon model 4430 deformation meter	17
Vertical strain measurements in intact rock and over single fractures	Geokon model 4200 strain gauge	7

Table 2.2. Summary of complementary instruments.

Parameter measured	Instrument type	Total number installed
Horizontal deformation perpendicular to the axis of the deposition hole	Geokon model 4430 displacement transducer	32
Vertical strains beneath the deposition hole	Geokon model 4200 strain gauge	8

The layout of the primary instruments around the deposition holes is shown in Figures 2.1 and 2.2. A total of eight 60mm diameter boreholes (four around each of the two deposition holes) were drilled. The majority of the instruments were installed within these boreholes. These holes are designated as A, C, E and G- 5 and 6. In addition, a total of four 76mm diameter boreholes (two at each deposition hole) were drilled to shallower depths to allow installation of the soft stress cell meters. These larger diameter holes are designated as H and D-5 and 6.

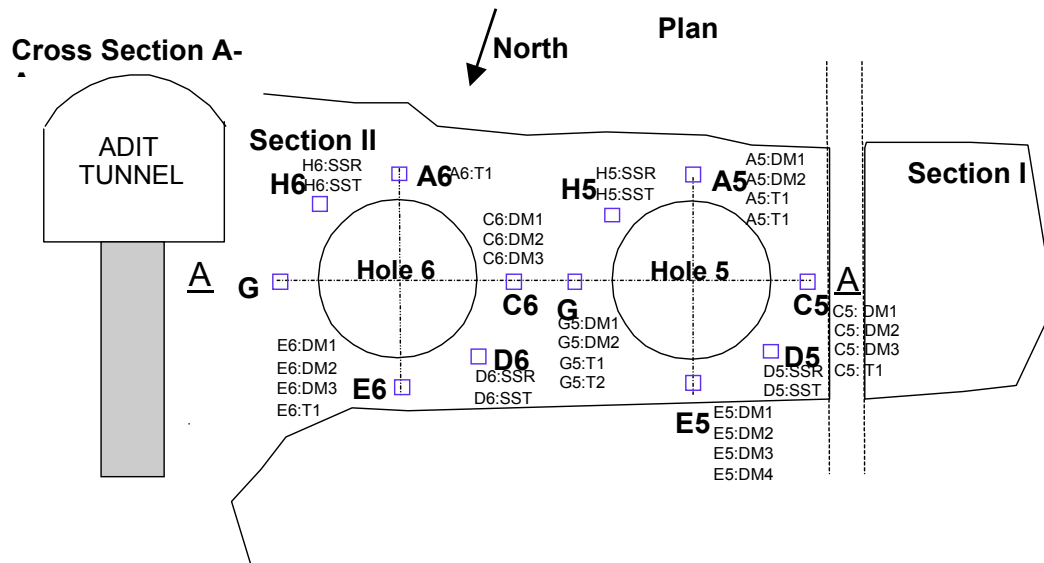

Figure 2.1 Primary instrument locations in plan view.

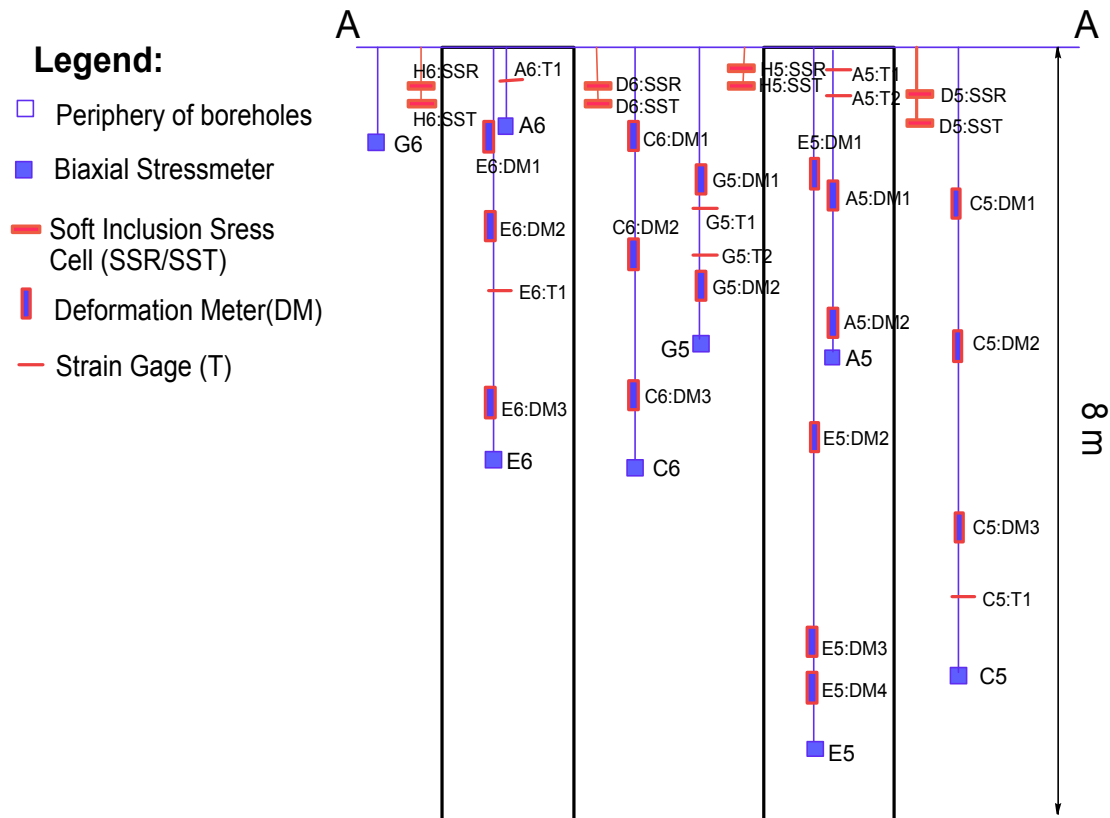

Figure 2.2 Primary instrument locations in elevation view.

Installation of the complementary instruments took place following drilling of ten boreholes having about a 75mm diameter from within the two deposition boreholes. The locations of these ten boreholes are shown schematically as well as in plan and elevation in Figures 2.3 to 2.6. The instruments installed within these boreholes consisted of displacement transducers ranging in length from 0.3m to 1.2m, and strain gauges which were 0.15m in length.

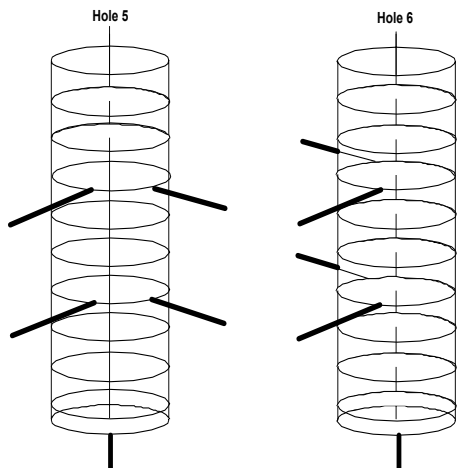

Figure 2.3 Schematic view of complementary boreholes.

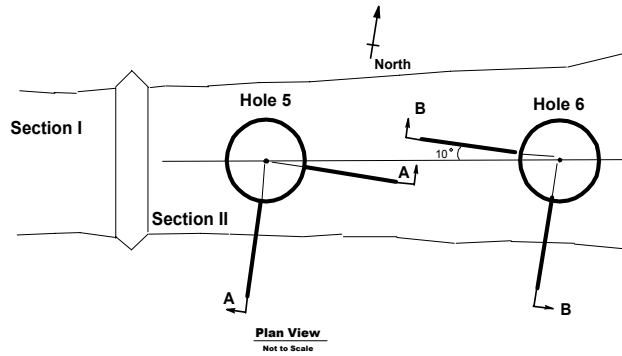

Figure 2.4 Plan view of complementary boreholes.

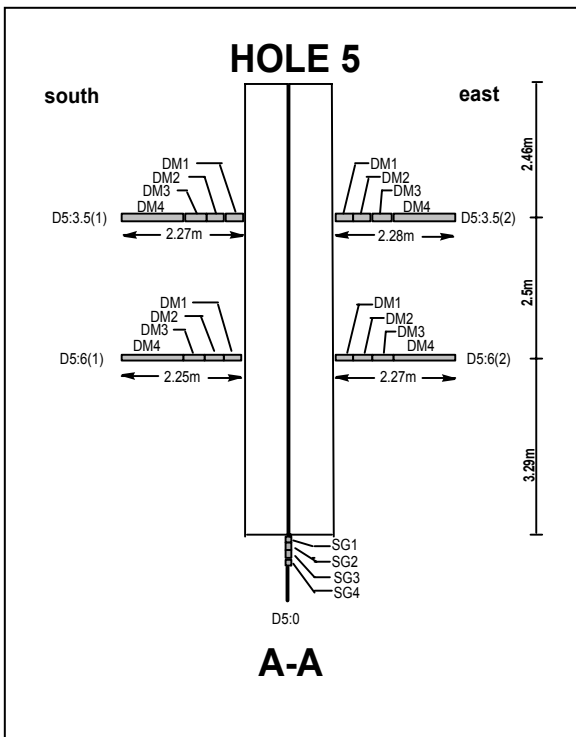

Figure 2.5 Elevation view of complementary instruments in Deposition Hole 5.

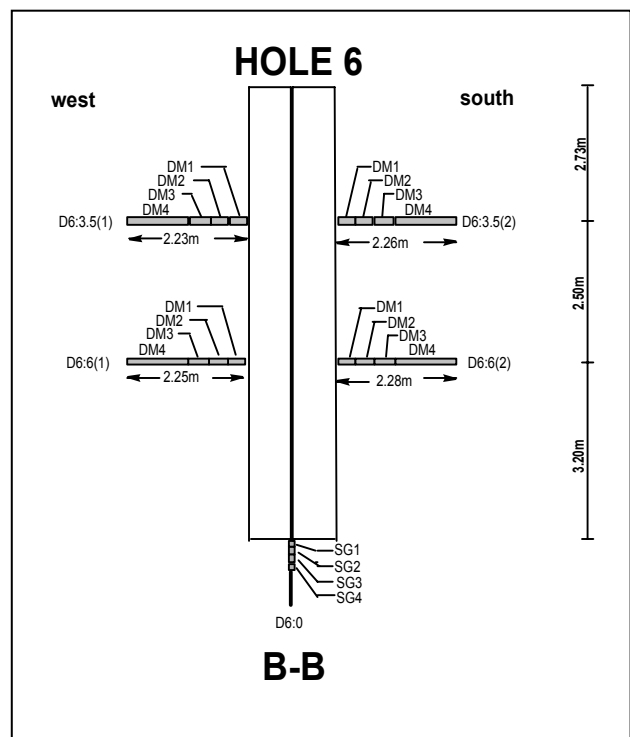
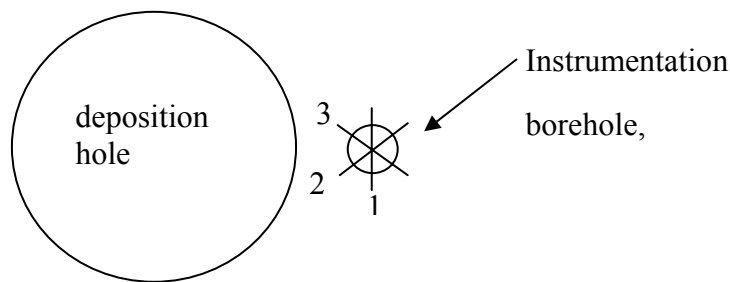

Figure 2.6 Elevation view of complementary instruments in Deposition Hole 6.

2.2 Stress measurements

2.2.1 Vibrating wire embedment biaxial stressmeters

The Geokon model 4350 vibrating wire biaxial stressmeter was installed for monitoring stress changes. This instrument was designed to measure compressive stress changes in rock, salt, concrete or ice. The instrument consists of a stiff high-strength steel cylinder, which is grouted into a BX (60 mm) size borehole. Stress changes in the host material cause the cylinder to deform, and the deformations in the plane perpendicular to the borehole are measured by means of two sets of three vibrating wire sensors spaced at 60° intervals (measurements are made at two levels within the cylinder). The gauges also include two longitudinal strain sensors and temperature sensors. The deformation of the steel cylinder, and resulting changes in resonate frequency of the vibrating wires, are used to determine both the magnitude and orientation of the change in stress in the host material.



Installation of the stressmeter gage is accomplished by inserting the gage into a grout-filled borehole using a setting tool and self-aligning setting rod. The stress cell is orientated so that the first vibrating wire is orientated tangentially to the canister hole. The second wire is orientated 60° from tangential direction and the third wire is orientated 120° from tangential direction.

2.2.2 Vibrating wire soft inclusion stress cell

The Geokon model 4360 soft inclusion stress cell is designed to measure changes in borehole diameters caused by changes in stress in rock and concrete. In use, an instrumented steel ring is installed in a borehole and pre-stressed in place by forcing platens into contact with the borehole walls. A vibrating wire strain gage measures the deformation of the ring, which is also the deformation of the borehole. Both compressive and tensile measurements can be made. Unlike the biaxial stressmeters that contain sets of 3 vibrating wires, the soft stress cells measure deformation changes in only one direction. For this reason the soft stress cells are installed in pairs to measure stress changes tangential and radial to the deposition holes.

2.3 Deformation gages

Deformations around the deposition holes are measured with deformation gages installed both within the same boreholes used for the biaxial stressmeters, as well as in the horizontal complementary boreholes.

The Geokon model 4430 Deformation gage is designed to measure longitudinal deformations in boreholes. The deformation meter consists of a tube with an anchor at each end. Within the tube a beam of graphite will transfer any distance changes between the two anchors to a vibrating wire sensor. In each deformation meter a temperature sensor is included for temperature corrections.

2.4 Embedded strain gages

At some particular locations, Geokon model 4200 strain gages have been installed over single fractures. This model gauge is designed for direct embedment in cast concrete and for installation in grouted boreholes. A steel wire is tensioned between two end blocks and the strain of the wire is measured using the vibrating wire principle. Deformations in the rock mass induced movements of the hard cement causing the two end blocks to move in relation to each other across a joint, thereby altering the tension in the wire. The tension in the wire is measured by plucking the wire and measuring its resonant frequency of vibration using an electromagnetic coil.

2.5 Cement

Special expansive grout was used to insure that the gage is in complete contact with the surrounding rock. The instruments are grouted in special cement from Denmark named Densitop T2. This cement is chosen to have as similar properties as the rock as possible. The compression strength is 150 Mpa. The coefficient of expansion is approximate 8.5 microstrain/C° that is similar to hard rock as granite and as 85 % of common concrete.

2.6 Registration

Two datalogger type Campbell CR10X have recorded the measurements, which have typically been recorded once every four hours during the period 2008-06-01 to 2008-11-30.

3 Computer processing of field data

3.1 Evaluation of stresses from biaxial stressmeters

The stress changes are evaluated from the measured deformations registered by the vibrating wires.

3.2 Radial deformations

Radial deformation for each of the vibrating wires are calculated with the equation:

$$V_r = (R_1 - R_0) * \text{Gagefactor} \quad (\text{mm/ digit})$$

V_r = Radial deformation for each of the vibrating wires

R_1 = Deformation reading in digits (= frequency² / 1000)

R_0 = Deformation zero reading in digits (= frequency² / 1000)

3.3 Calculation of deformation to stresses

The magnitude and the direction of the stress changes are determined from the measured radial deformation of the sensor in three directions.

The equations below give the magnitude and the direction of the maximum stress increase and reduction in a plane perpendicular to the borehole axes:

Maximal stress increase

$$p = \frac{1}{2} \left[\frac{1}{3B} \left((2V_{r_1} - V_{r_2} - V_{r_3})^2 + 3(V_{r_2} - V_{r_3})^2 \right)^{1/2} + \frac{1}{3A} (V_{r_1} + V_{r_2} + V_{r_3}) \right]$$

V_{r_1} = Radial deformation for vibrating wire 1

V_{r_2} = Radial deformation for vibrating wire 2

V_{r_3} = Radial deformation for vibrating wire 3

A, B = Coefficients depending on the sensor geometry and the material properties

Maximal stress reduction

$$q = \left[\frac{1}{3A} (V_{r_1} + V_{r_2} + V_{r_3}) - p \right]$$

The angle of the maximal stress increase

The angle in the plane perpendicular to the borehole axes is measured clockwise from the tangential direction of the canister hole.

$$\theta = \frac{1}{2} \cos^{-1} \left[\frac{V_n - A(p+q)}{B(p-q)} \right]$$

3.4 Evaluation of stress from soft inclusion stress cells

The eight soft inclusion stress cells each contain one vibrating wire which is mounted at a 90° angle from measured direction of stress. Therefore an increase in the readings in digits indicates a reduction on borehole diameter.

The change in the diameter of the borehole is calculated as follows:

$$D = (R_1 - R_0) * G$$

Where R_1 and R_0 are the current and initial readings respectively, in units of digits (frequency² / 1000), and

G is the gage factor in units of (mm/digit)

3.5 Evaluation of deformation

Deformation measurements taken with the Geokon Model 4430 deformation meters were calculated as temperature compensated deformation with the following equations:

$$\text{Deformation}_{\text{corr}} = ((R_1 - R_0) * C) + ((T_1 - T_0) * K) + L_c$$

Where R_1 and R_0 are the current and initial readings respectively, in units of digits (frequency² / 1000),

T_1 and T_0 are the current and initial temperatures respectively in C°,

C is the gage specific calibration factor

K is the thermal coefficient based on the following equation:

$$K = ((R_1 * M) + B) * C$$

$$\text{Where } M = 0.000295, \text{ and } B = 1.724$$

L_c is the gage length correction based on the following equation:

$$L_c = (17.3 * 10^{-6}) * (\text{Length of the deformation meter} - \text{transducer length}) * (T_1 - T_0)$$

For the gages installed at the Prototype project the transducer length is 267 mm

3.6 Evaluation of strain

Strain measurements taken with the Geokon Model 4200 gages were calculated as temperature compensated strain with the following equation:

$$\mu\epsilon_{true} = (R_1 - R_0) * GF * B + (T_1 - T_0)(C_1 - C_2)$$

$\mu\epsilon_{true}$ = temperature compensated microstrain

R_1 and R_0 = Digits reading

GF = theoretical gage factor

B = batch calibration factor

C_1 and C_2 are the coefficients of expansion of steel and concrete, 12.2 microstrain/ C° and 8.5 microstrain/ C° .

3.7 Material parameters

Material parameters used in the calculations are as the following:

- Young's modulus of intact rock 69 Gpa
- Poisson's ratio of intact rock 0.25
- Coefficients of expansion of steel 12.2 microstrain/ C°
- Coefficients of expansion of concrete 8.5 microstrain/ C°

3.8 Processing

The raw data which have been collected using Multilogger software have been processed using Microsoft Excel software.

4 Results

4.1 Overview and comments

The measurement results are presented graphically for each of the sensors in the following sections for the primary and complementary instruments. It should be noted that the readings are currently uncompensated for the temperature effects.

A new multiplexer was installed in early June and readings were very good for a while. The recordings were not continuous over the period with a major break from September through out the period. A short circuit shut down datalogger 1 due to major water problem. It seems that water is still coming in to mux1.

4.1.1 Biaxial stress meter results

The readings are, until early September due to water problem, stable. Some problems with noise and communication that have been noticed previous periods can be seen during this period. It seems that the problems have decreased from the last period.

In Sensor C5, E5, C6, E6 and G6 there were problems with most of the wires throughout this period and no recordings were made.

There are no or very small changes in stress around canister hole 5 and 6. The temperature has also been rather constant.

4.1.2 Soft inclusion stress cell

There have been very small or no stress changes for the sensors around deposition hole 5 and 6. Generally the stress sensors are showing very steady values with small or almost no noise throughout the period. The temperature readings are, however, still somewhat unstable. No major changes since last period.

4.1.3 Deformation measurements in vertical primary boreholes

The deformation meters display stable readings with very small changes. However, some minor noise in some sensors can be over the entire period.

4.1.4 Strain measurements in vertical primary boreholes

The readings are stable and indicate no changes over the period when no readings were made. Some minor problem with noise can be seen.

4.1.5 Deformation measurements in D5 horizontal complementary boreholes

Still no communication with D5_6_2Def1 and D5_35_1Def_1, otherwise all readings are stable and there are small or no changes in deformation. Minor problems with noise.

4.1.6 Deformation measurements in D6 horizontal complementary boreholes

There is still some noise around D6:6(1) and D6:6(2). The readings are mostly stable with no or small changes.

4.1.7 Strain measurements in complementary boreholes

The readings from the strain gauges at deposition hole 5 are stable with small changes and steady temperature

The strain gauges show a decrease of noise at deposition hole 6 and the general tendencies show stable readings with no or very small changes in strain and unchanged temperature. However, the problem with the recording is evident due to the water problem.

4.2 Graphical presentation of results

4.2.1 Biaxial Stressmeter results

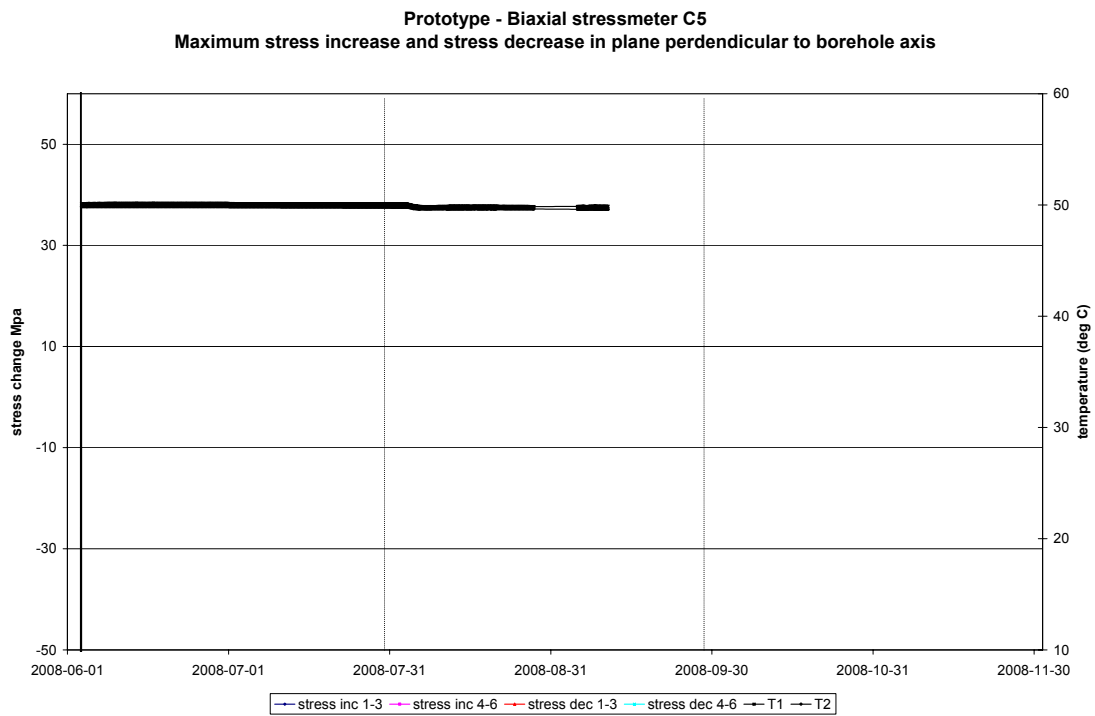
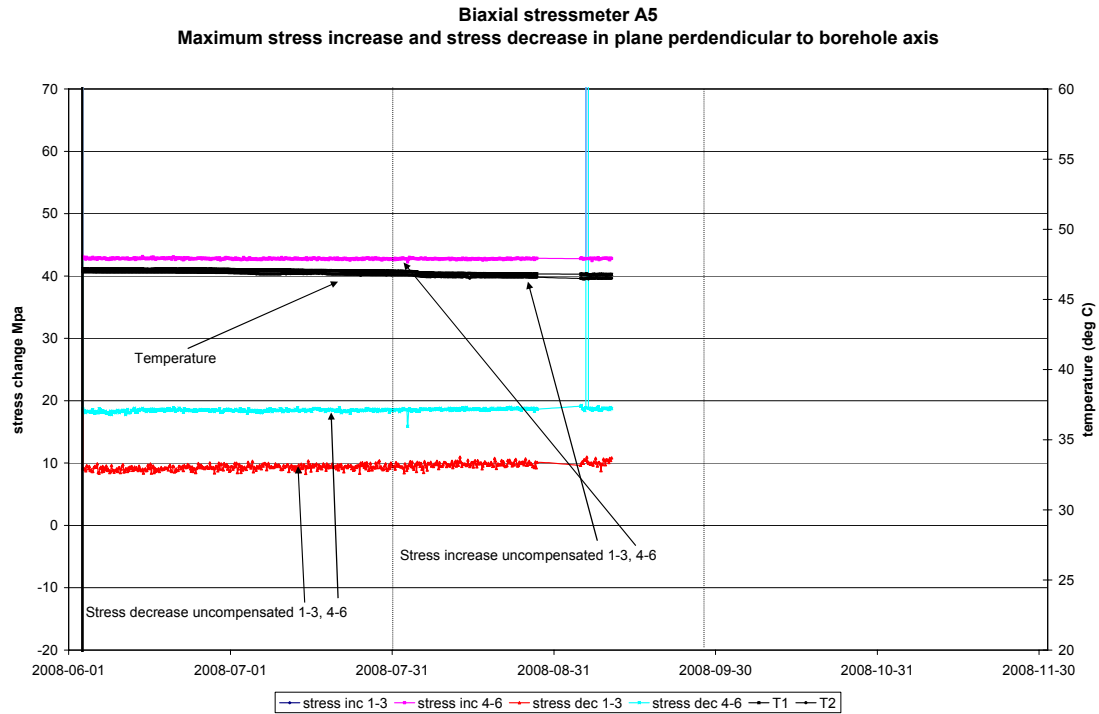

Biaxial stressmeter E5
Maximum stress increase and stress decrease in plane perpendicular to borehole axis

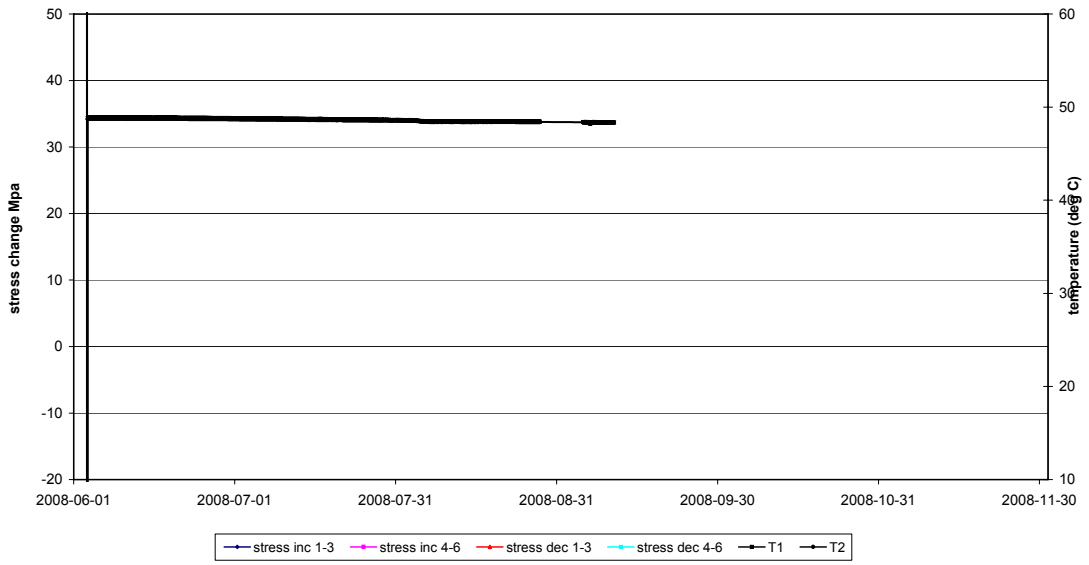

Biaxial stressmeter G5
Maximum stress increase and stress decrease in plane perpendicular to borehole axis

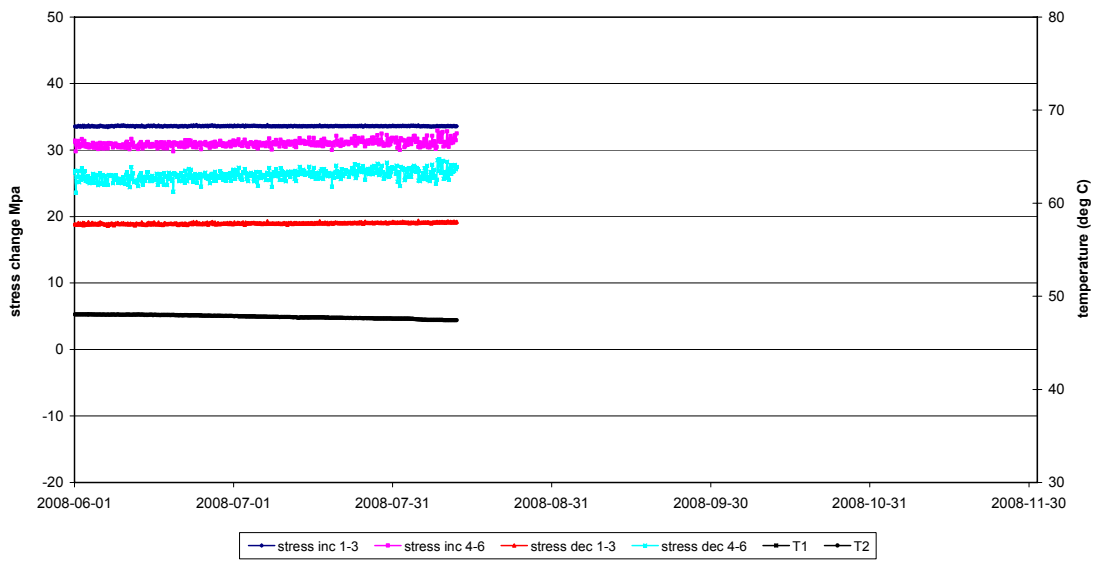

Biaxial stressmeter A5
Maximum stress increase and stress decrease in plane perpendicular to borehole axis

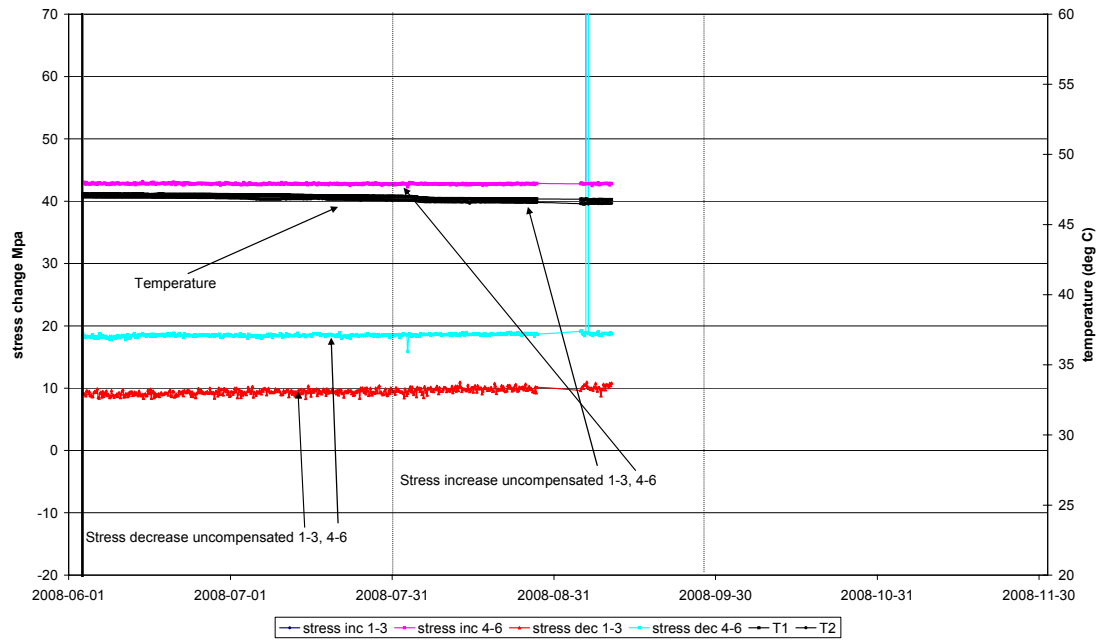

Biaxial stressmeter C6
Maximum stress increase and stress decrease in plane perpendicular to borehole axis

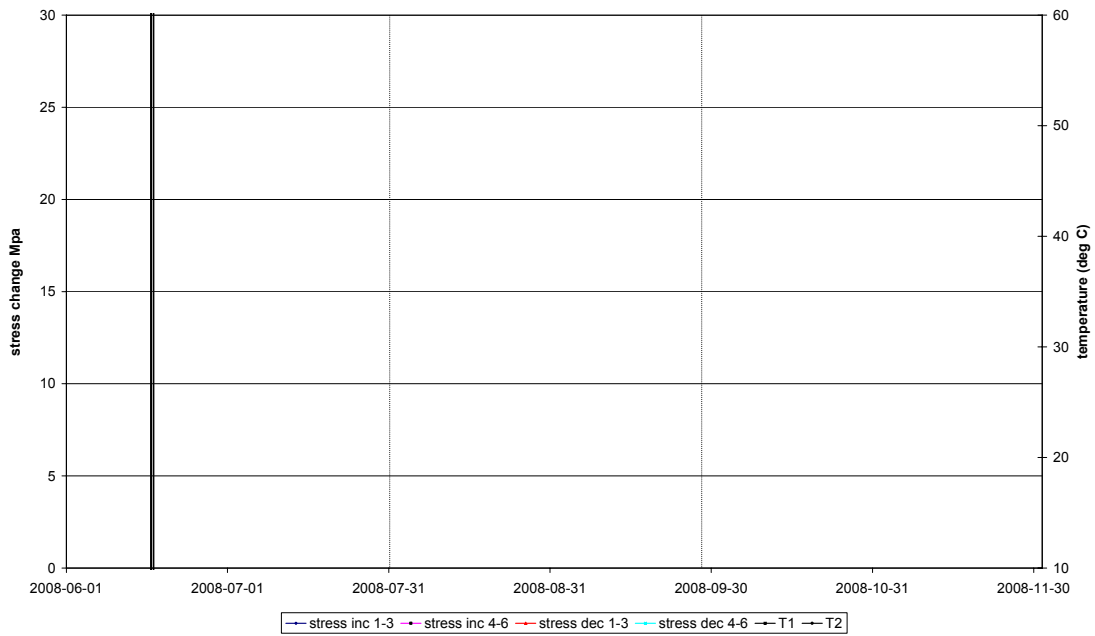

Biaxial stressmeter E6
Maximum stress increase and stress decrease in plane perpendicular to borehole axis

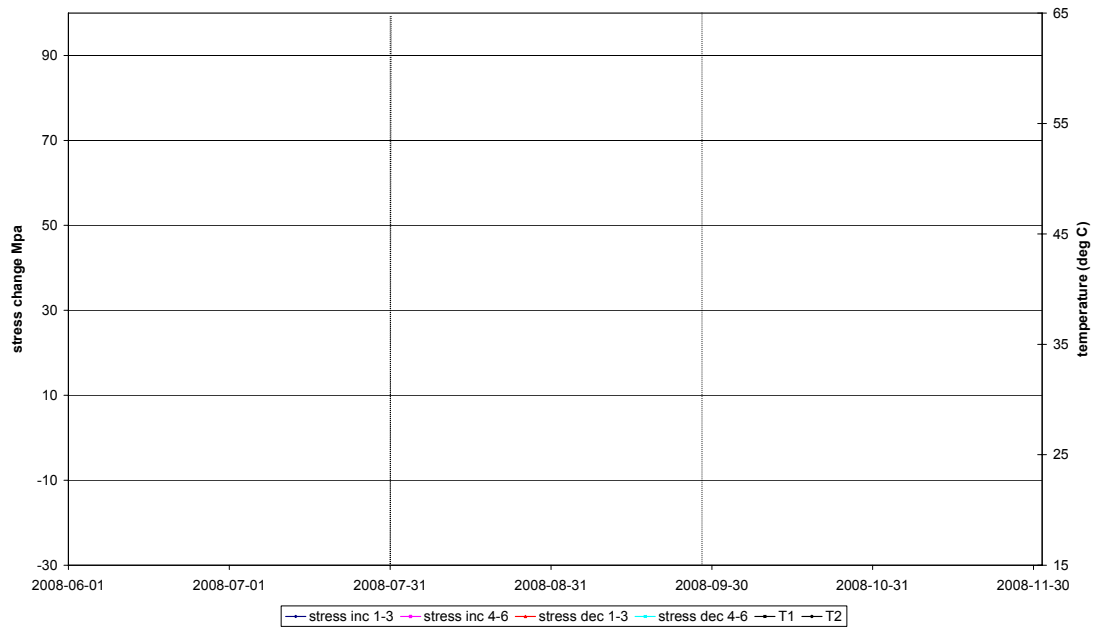

Biaxial stressmeter G6
Maximum stress increase and stress decrease in plane perpendicular to borehole axis

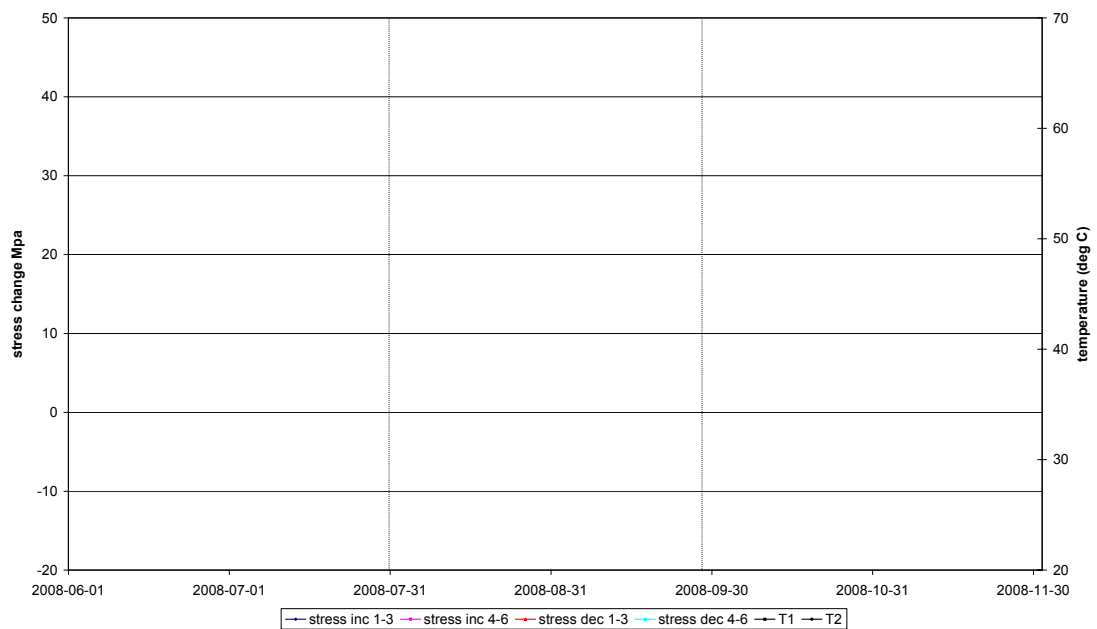

4.2.2 Soft inclusion stress cell results

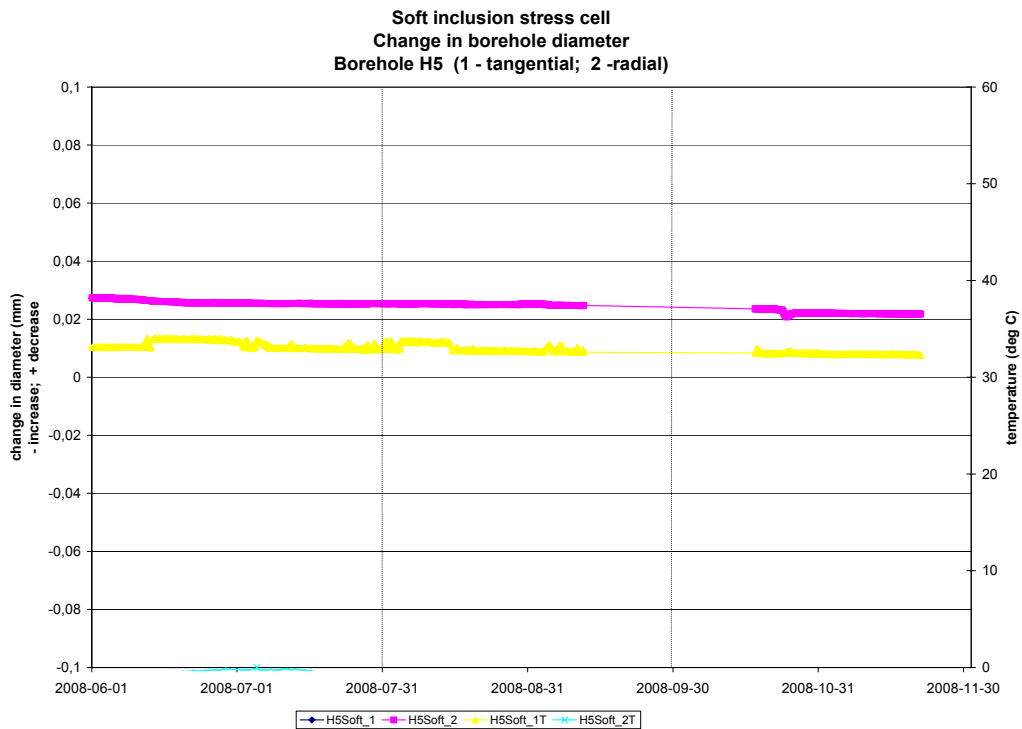
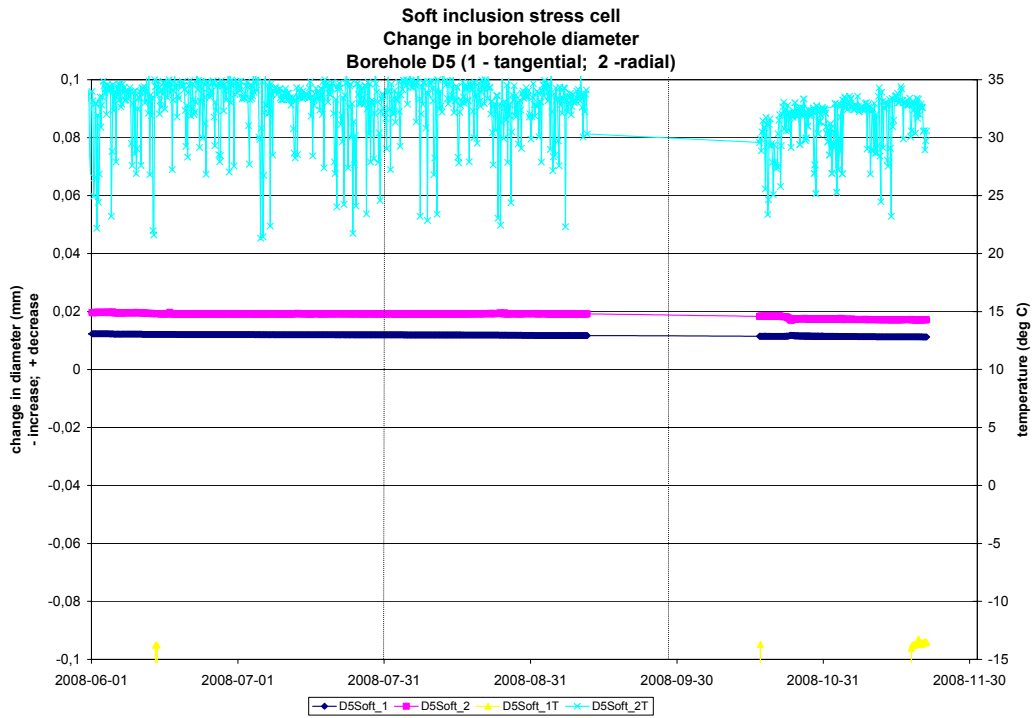

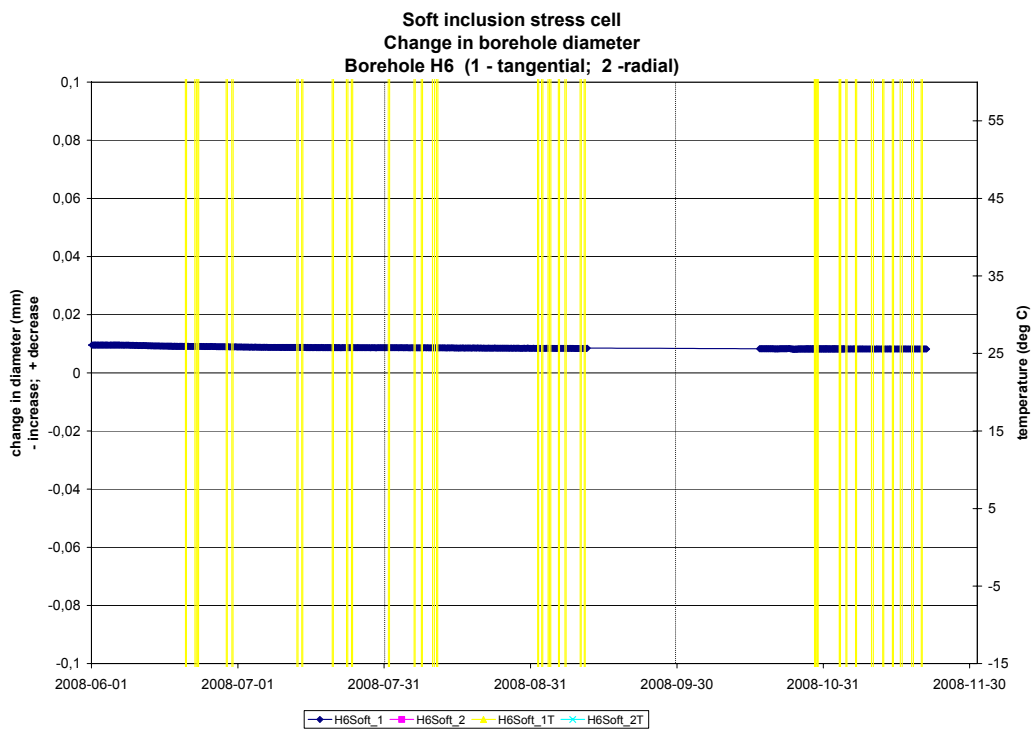
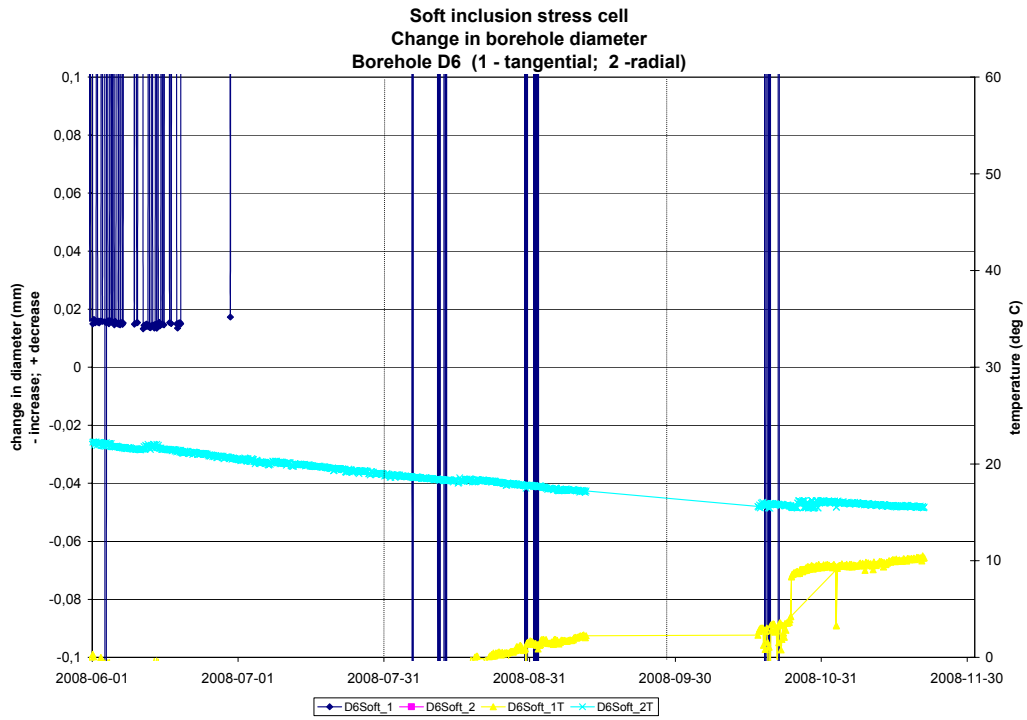

4.2.3 Deformation measurements in vertical primary boreholes

Vertical deformations adjacent to Deposition Hole 5
in Borehole E5

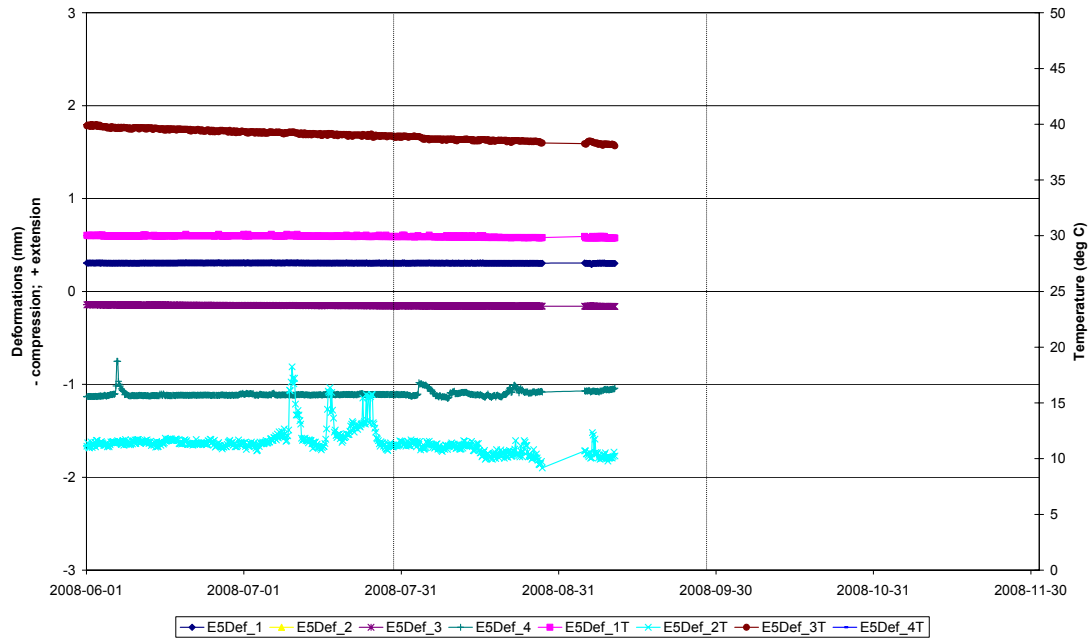

Vertical deformations adjacent to Deposition Hole 5
in Boreholes G5 and A5

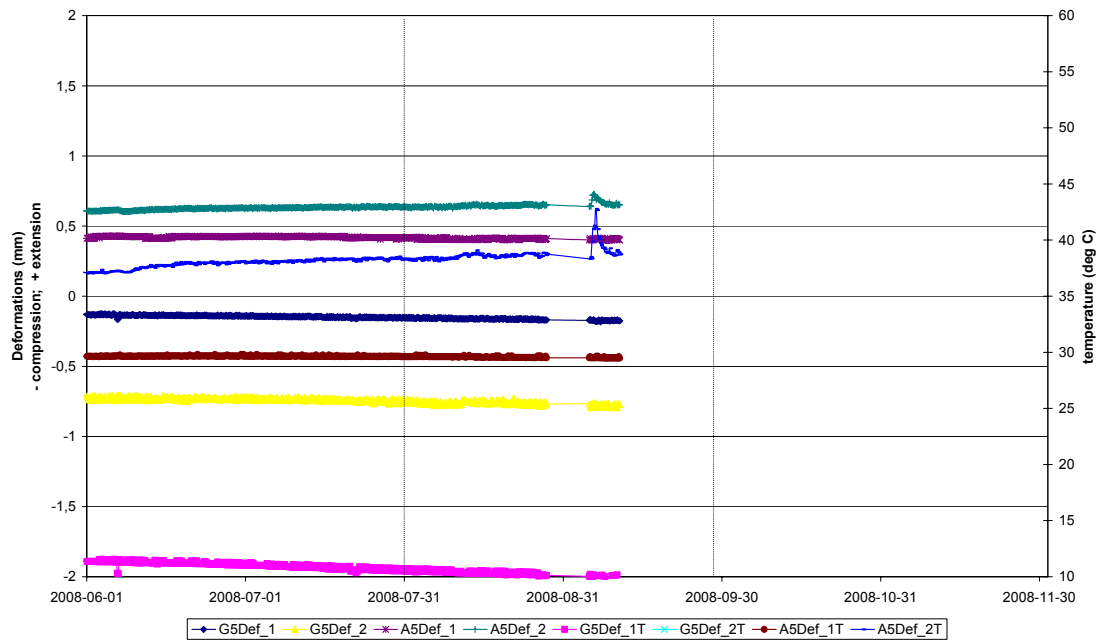

Vertical deformations adjacent to Deposition Hole 5
in borehole C5

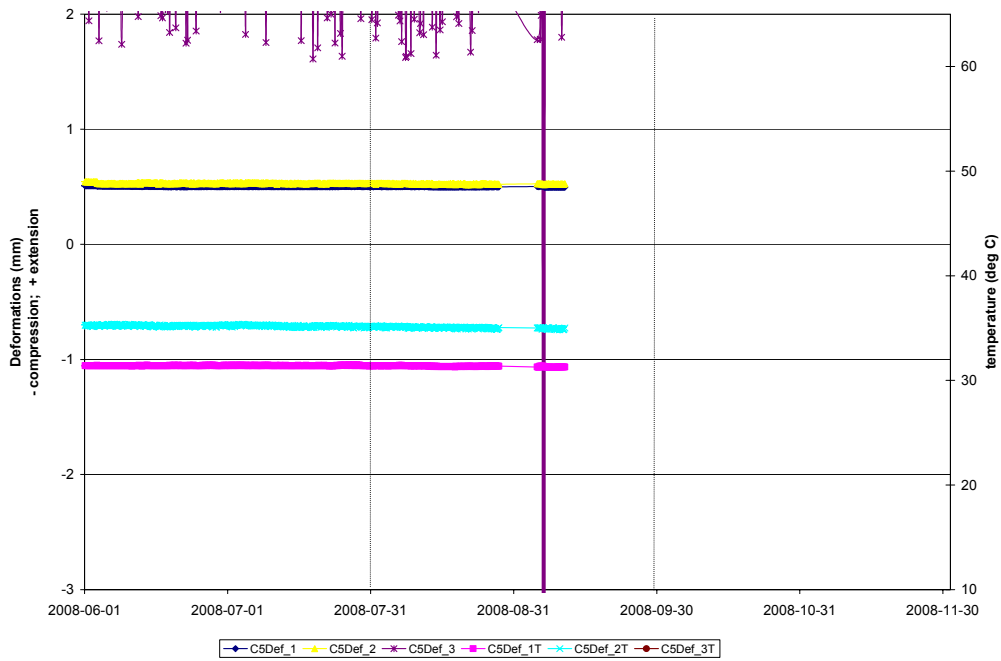

Vertical deformations adjacent to Deposition Hole 6
in borehole C6

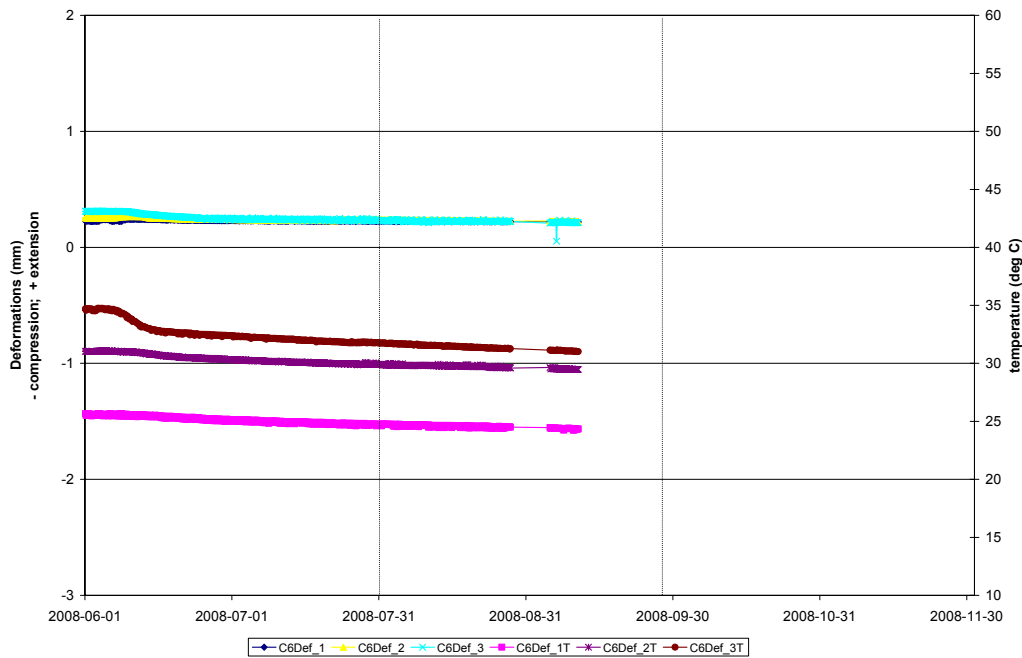

Vertical deformations adjacent to Deposition Hole 6
in borehole E6

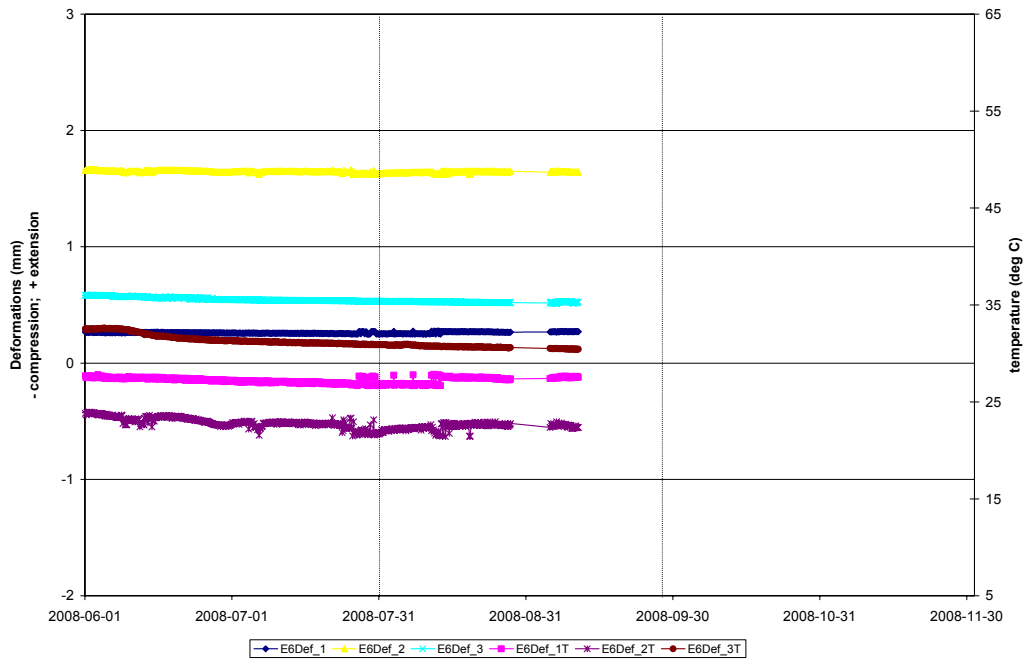

4.2.3 Strain measurements in vertical primary boreholes

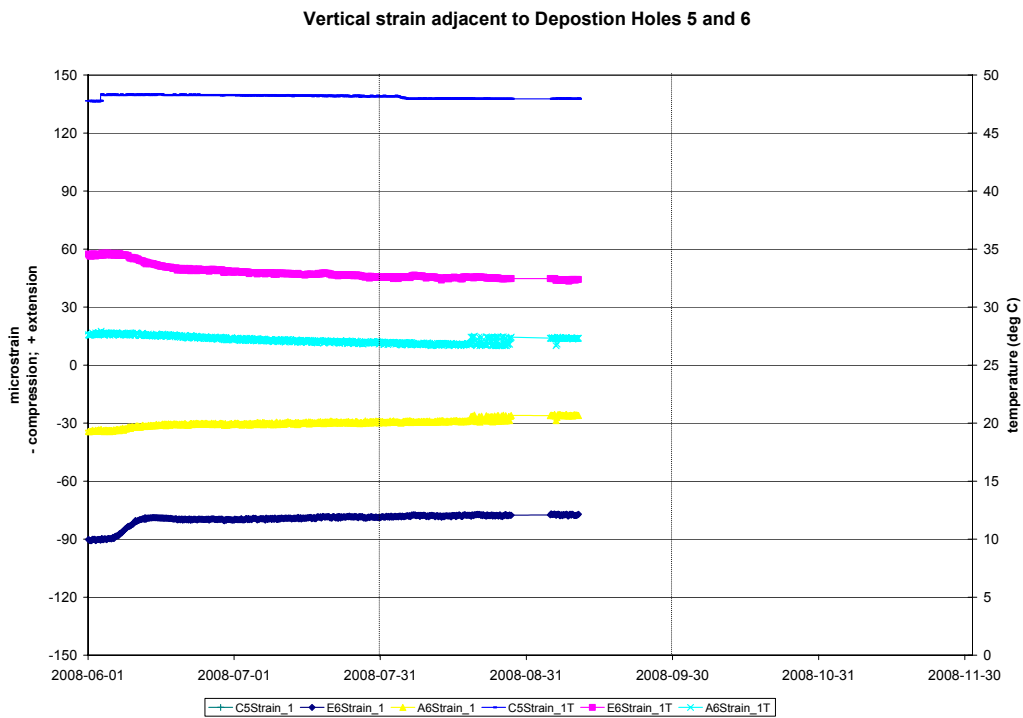
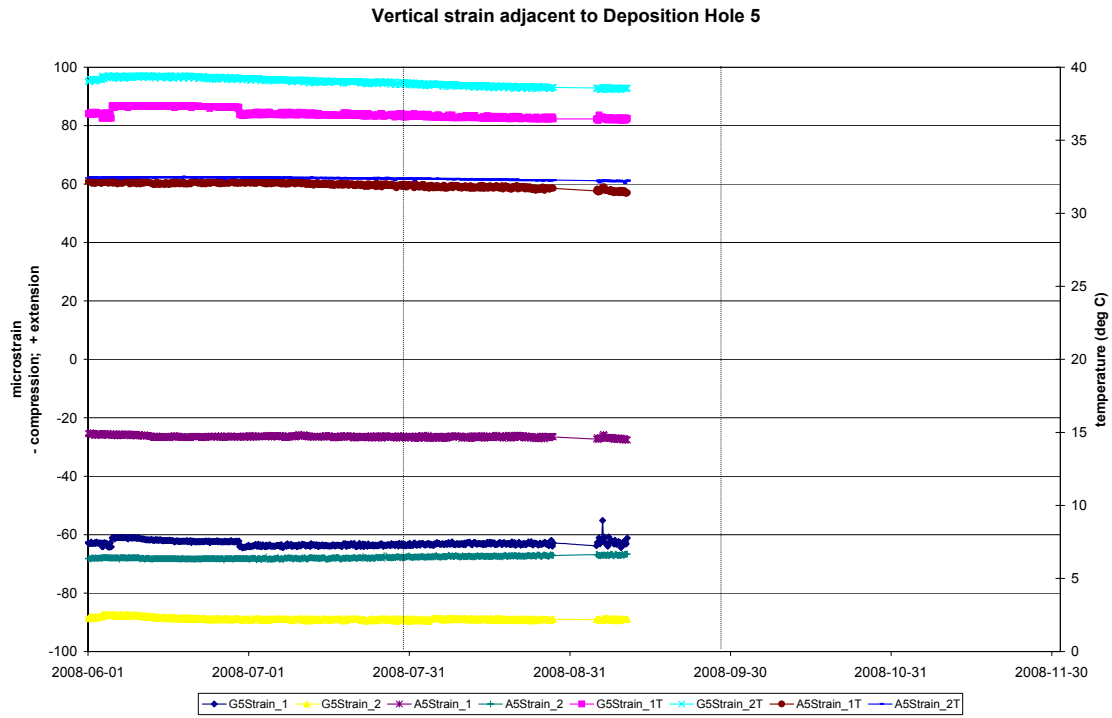

4.2.4 Deformation measurements in horizontal complementary boreholes

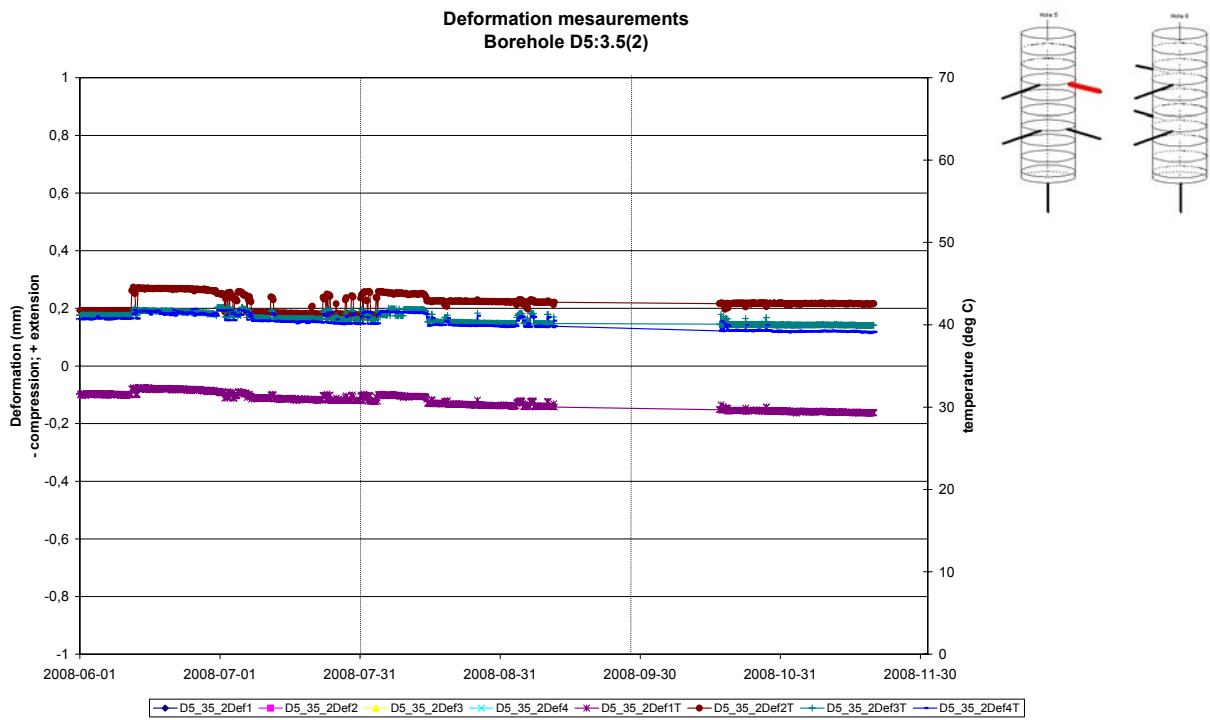
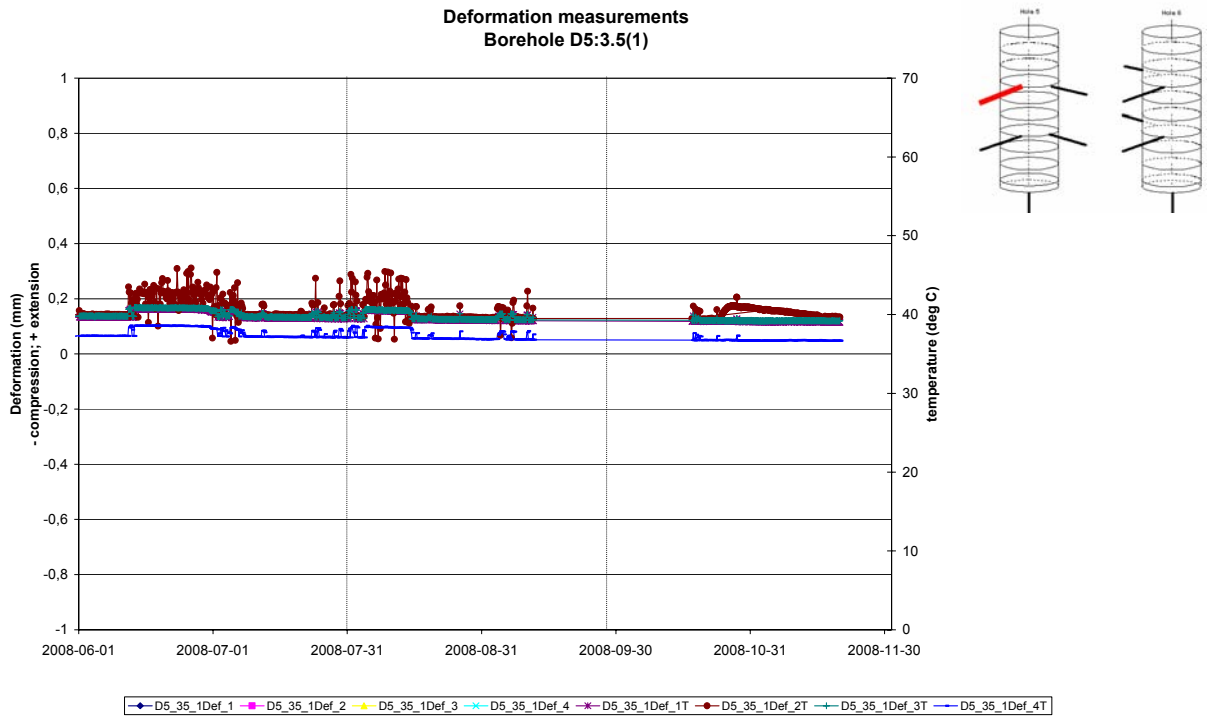

Deformation measurements
Borehole D5:6(1)

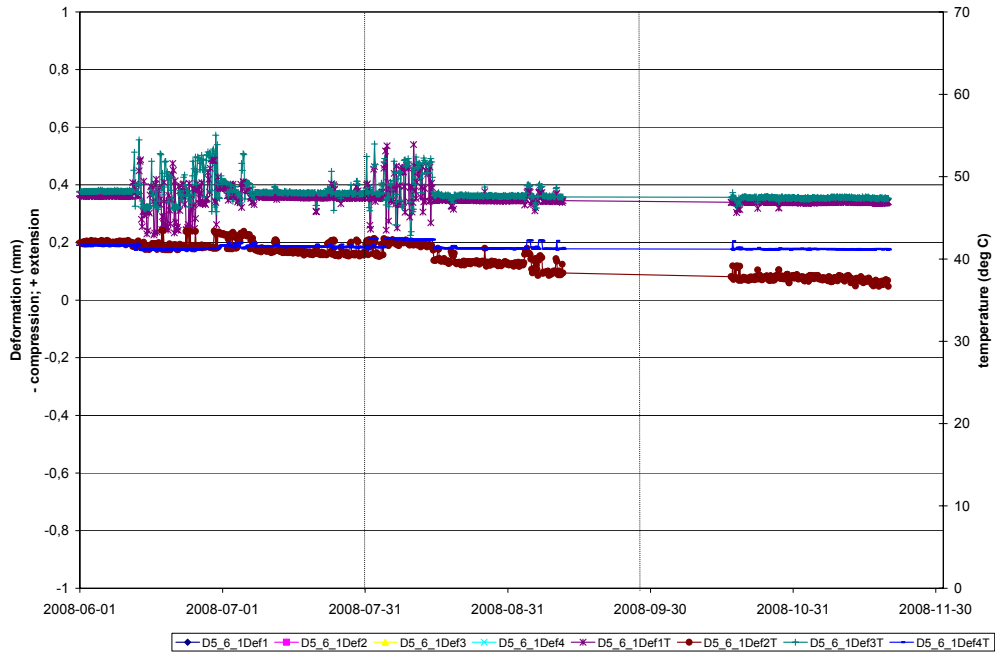

Deformation measurements
Borehole D5:6(2)

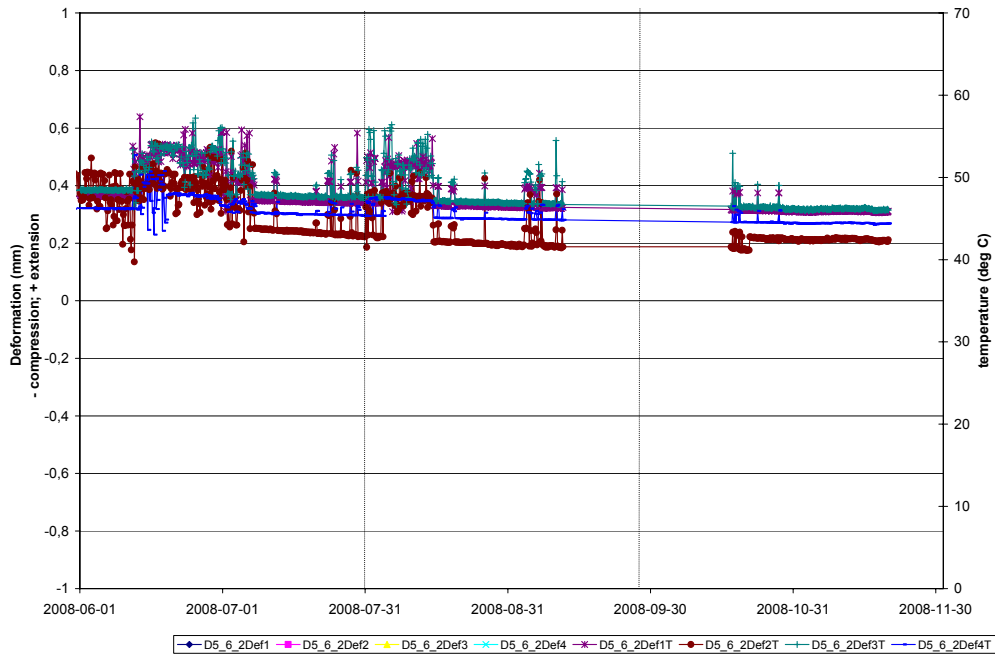

Deformation measurements
Borehole D6:3.5(1)

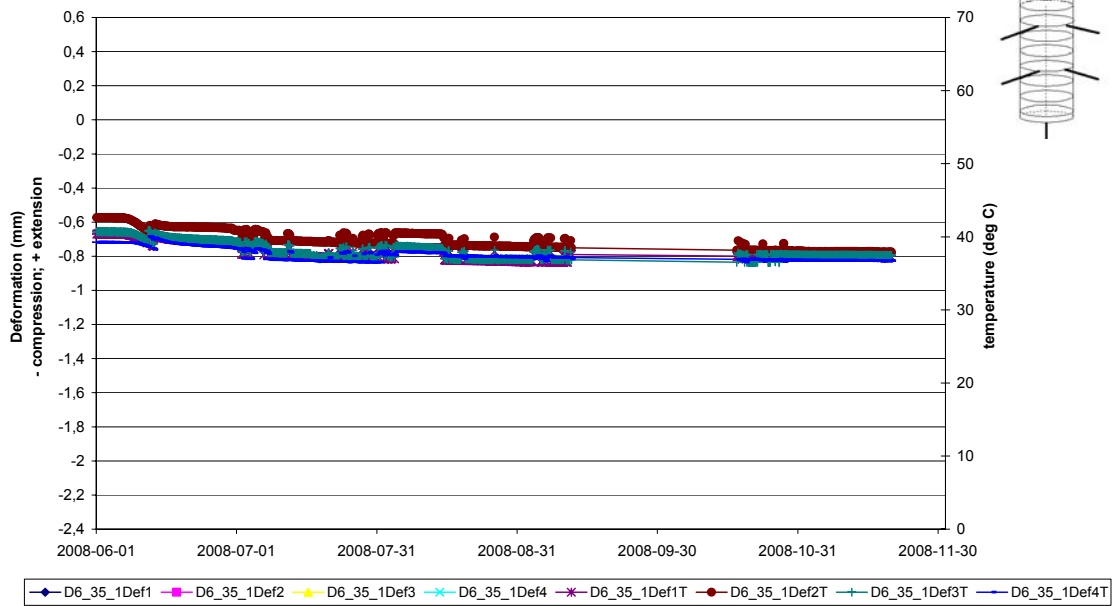

Deformation measurements
Borehole D6:3.5(2)

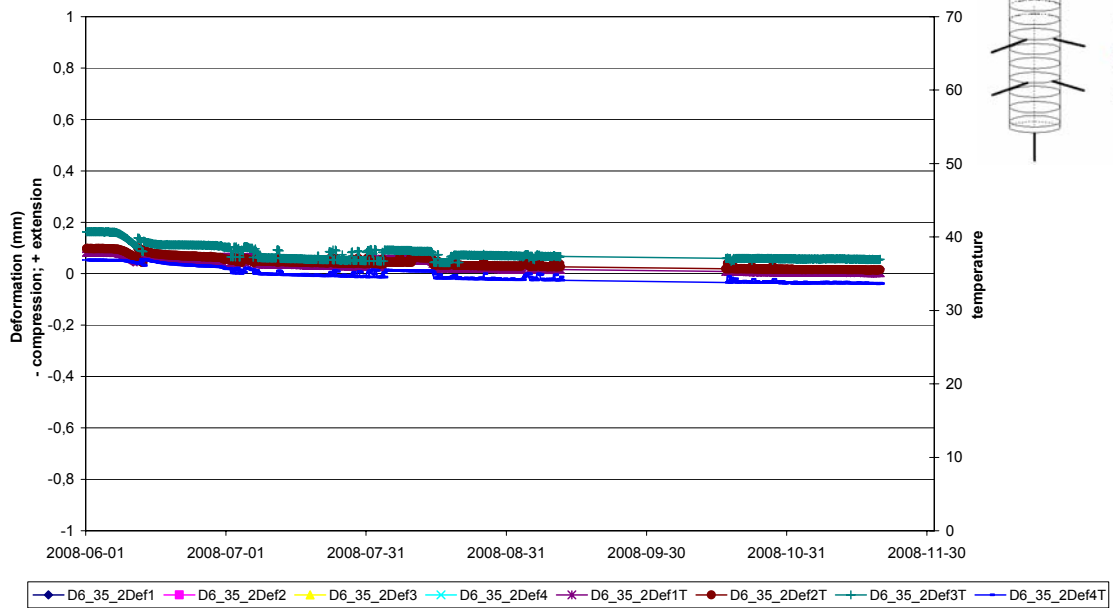

Deformation measurements
Borehole D6:6(1)

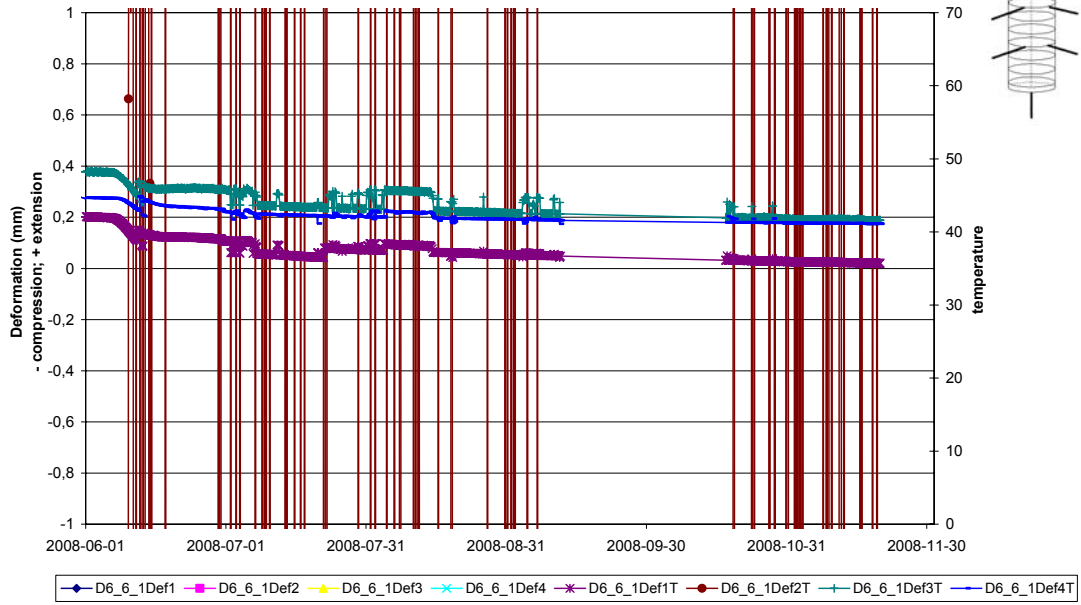

Deformation measurements
Borehole D6:6(2)

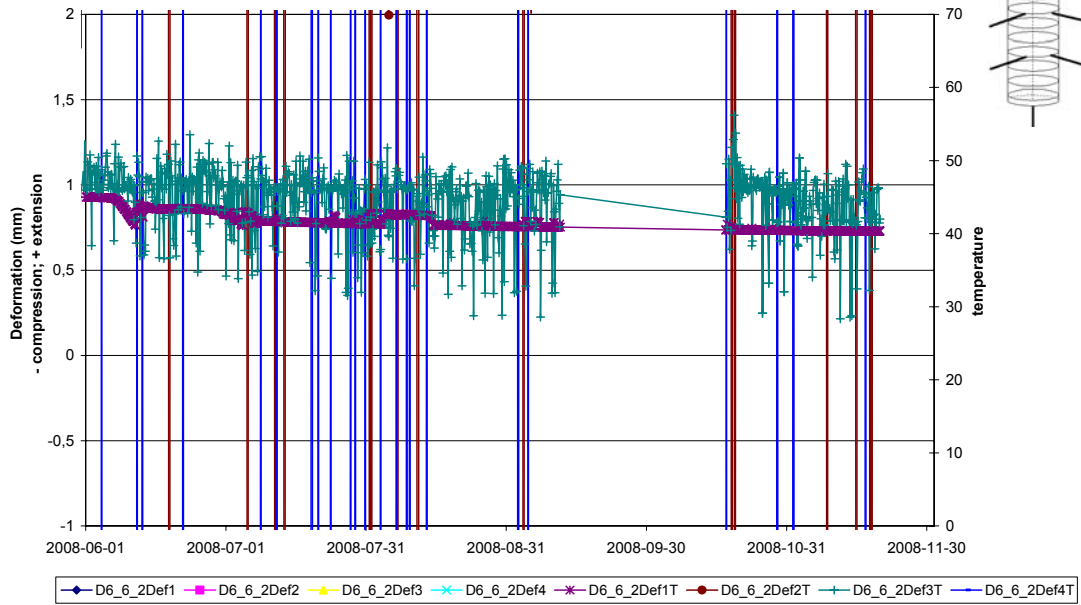

4.2.5 Strain measurements in complementary boreholes

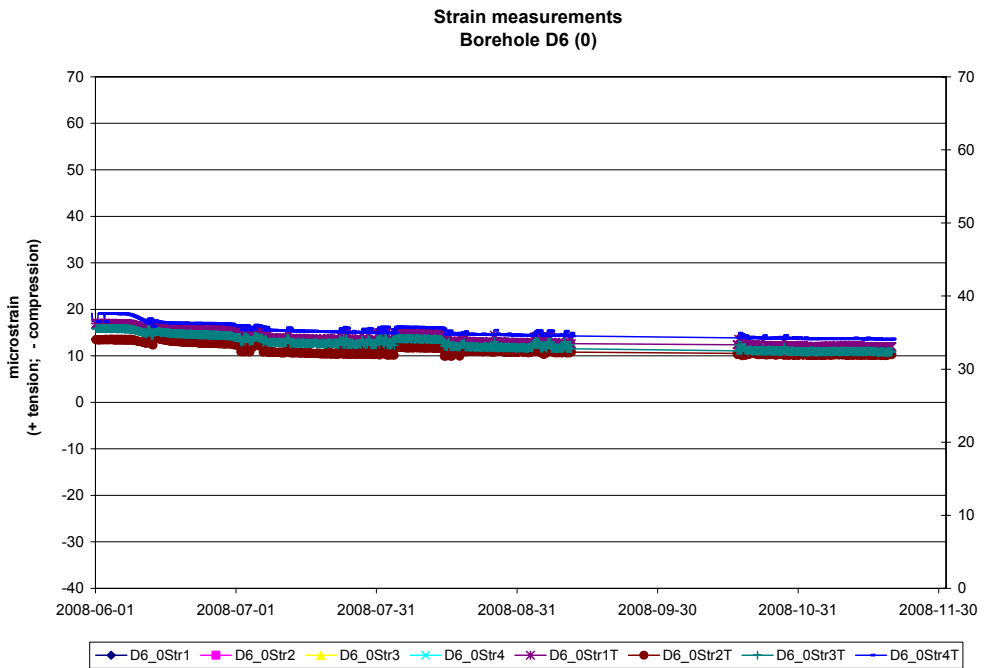
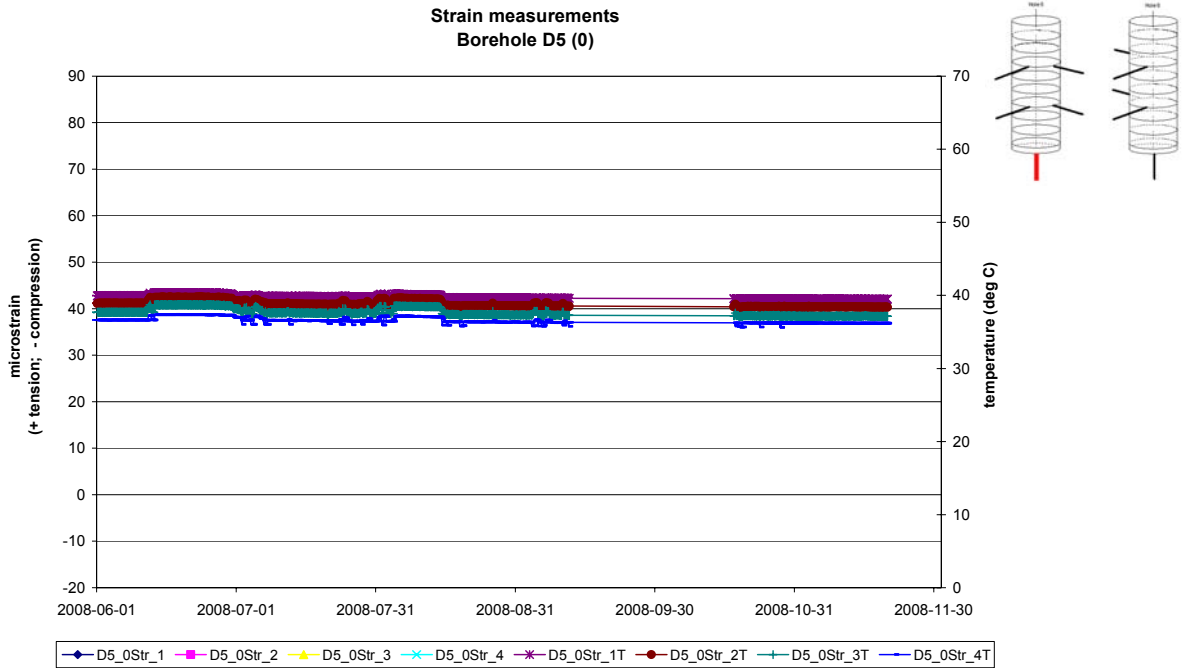

Appendix 11

Water pressure in the rock and flow measurements

Rhén I. and Forsmark T., SWECO Environment AB

Period 2001-09-01 – 2008-12-01

Water pressure measurements in the rockmass

Introduction

The hydraulic properties of the rock, geometry of tunnels and deposition holes, water pressure far away from the tunnels and the hydro-mechanical properties of the backfill and buffer govern the saturation of the buffer and backfill. It is important to measure the water pressure in the rock for the interpretation of the measurements in the buffer and backfill and to sample data useful for the modelling of the saturation process.

A short summary of the instrumentation follows below. For more details see (*Rhén et al, 2001*).

Measurements in the boreholes

A large number of boreholes are instrumented with one or several packers. In all packed-off sections, the water pressure is measured. Each borehole section is connected to a tube of polyamide that via lead-through holes ends in the G-tunnel. All pressure transducers are placed in the G-tunnel to facilitate easy calibration and exchange of transducers that are out of order. The transducers are connected to the HMS system at Äspö Laboratory and it is a flexible system for changing the logging frequency. The maximum scan frequency is 1/second. During periods with no hydraulic tests, preliminary the logging (storing a value in the data base) frequency is 2/hour with an automatic increase of the sampling frequency if the pressure change since last registration is larger than 2kPa. During hydraulic tests, the sampling frequency is up to 1 logging every 3rd second (maximum logging rate possible).

Instrumentation with bentonite packers in Section I

Section I will be in operation for a long time, possibly up to 20 years, and there will be no access to the instruments in the boreholes for a long period. It was decided to develop a new type of packer that was not dependent of an external pressure to seal-off the borehole sections. These packers are made of compacted bentonite with rubber coverage. For chemical reasons the bentonite is not allowed to be in contact with the surrounding water in the rock mass and therefore the packers have a cover made of polyurethane (PUR-rubber). This rubber also protected the packers against unwanted wetting during transport and installation. After installing all packers in a borehole, the compacted bentonite was wetted to make it swell and expanded against the borehole wall. This packer system is used in 14 boreholes with a length between 12 and 50 meters in the tunnel floor and the walls, see (*Rhén et al, 2001*).

Due to the expected high temperature near the deposition holes two boreholes (KA3574A and KA3576A) were equipped with stainless steel pipes instead of polyamide tubes.

In some sections used for circulation or hydrochemistry sampling purposes in Section I, a dummy is installed to reduce the water-filled volume of the section. Depending on the purpose the dummies were made either by high-density polyethylene (circulation sections) or PEEK (hydrochemistry sections) material. The dummy consists of two parts, positioned around the centre rod.

The packers were inserted into the borehole with Ø 20 mm massive stainless steel rods. A special designed manual-hoisting rig was used to insert the equipment into the boreholes. When the packers were at their correct position the equipment was attached to a locking device mounted on the tunnel wall at the borehole collar. Before insertion, the equipment was cleaned with a cleaner delivering hot steam (100 °C) at high pressure.

The instrument configuration for the boreholes provided with bentonite packers is summarised in Table 1 and illustrated in Figures 1 and 2.

Table 1 Instrumentation configuration in Section I. “Lead-through”: pipes between the packers.

Borehole:sec	Sec. length (m)	Type of section	Type of dummy	Packer length	Lead-through (no:diameter:type)
KA3563G:1	15 – 30.01	P		2 m	1:6/4:PA
KA3563G:2	10 – 13	P		2 m	2:6/4:PA
KA3563G:3	4 – 8	P		1 m	3:6/4:PA
KA3563G:4	1.5 – 3	P, C	HD	1 m	6:6/4:PA
KA3566G01:1	23.5 – 30.01	P		2 m	1:6/4:PA
KA3566G01:2	20 – 21.5	P, C	HD	2 m	4:6/4:PA
KA3566G01:3	12 – 18	P		2 m	5:6/4:PA
KA3566G01:4	7.3 – 10	P		1 m	6:6/4:PA
KA3566G01:5	1.5 – 6.3	P, F		1 m	8:6/4:PA
KA3566G02:1	19 – 30.1	P		1 m	1:6/4:PA
KA3566G02:2	16 – 18	P, C	HD	2 m	4:6/4:PA
KA3566G02:3	12 – 14	P		1 m	5:6/4:PA
KA3566G02:4	8 – 11	P		2 m	6:6/4:PA
KA3566G02:5	1.3 – 6	P, F		1 m	8:6/4:PA
KA3572G01:1	7.3 – 12.03	P		2 m	1:6/4:PA
KA3572G01:2	2.7 – 5.3	P, C	HD	2 m	4:6/4:PA
KA3573A:1	26 – 40.07	P		2 m	1:6/4:PA
KA3573A:2	21 – 24	P, F		2 m	3:6/4:PA
KA3573A:3	14.5 – 19	P		2 m	4:6/4:PA
KA3573A:4	10.5 – 12.5	P, F		2 m	6:6/4:PA
KA3573A:5	1.3 – 8.5	P		1 m	7:6/4:PA
KA3574G01:1	8 – 12.03	P		1 m	1:6/4:ST
KA3574G01:2	5.1 – 7	P		1 m	2:6/4:ST
KA3574G01:3	1.8 – 4.1	P, C	HD	1 m	5:6/4:ST
KA3576G01:1	8 – 12.01	P		2 m	1:6/4:ST
KA3576G01:2	4 – 6	P, HC	PE	1 m	2:6/4:ST, 1:1/8"/2:PE
KA3576G01:3	1.3 – 3	P		1 m	3:6/4:ST, 1:1/8"/2:PE

Borehole:sec	Sec. length (m)	Type of section	Type of dummy	Packer length	Lead-through (no:diameter:type)
KA3578G01:1	6.5 – 12.58	P		1 m	1:6/4:PA
KA3578G01:2	4.3 – 5.5	P, HC	PE	2 m	2:6/4:PA, 1:1/8"/2:PE
KA3579G:1	14.7 – 22.65	P		1 m	1:6/4:PA
KA3579G:2	12.5 – 13.7	P		1 m	2:6/4:PA
KA3579G:3	2.3 – 11.5	P		2 m	3:6/4:PA
KA3584G01:1	7 – 12	P		2 m	1:6/4:PA
KA3584G01:2	1.3 – 5	P		1 m	2:6/4:PA
KA3590G01:1	16 – 30	P		1 m	1:6/4:PA
KA3590G01:2	7 – 15	P, F, F		1 m	4:6/4:PA
KA3590G01:3	1.3 – 6	P, HC		1 m	5:6/4:PA, 1:1/8"/2:PE
KA3590G02:1	25.5 – 30.01	P, F		2 m	2:6/4:PA
KA3590G02:2	15.2 – 23.5	P		2 m	3:6/4:PA
KA3590G02:3	11.9 – 13.2	P, HC	PE	2 m	4:6/4:PA, 1:1/8"/2:PE
KA3590G02:4	1.3 – 9.9	P		1 m	5:6/4:PA, 1:1/8"/2:PE
KA3593G:1	25.2 – 30.02	P		1 m	1:6/4:PA
KA3593G:2	23.5 – 24.2	P, HC	PE	1 m	2:6/4:PA, 1:1/8"/2:PE
KA3593G:3	9 – 22.5	P		2 m	3:6/4:PA, 1:1/8"/2:PE
KA3593G:4	3 – 7	P, F		2 m	5:6/4:PA, 1:1/8"/2:PE
KA3600F:1	43 – 50.1	P		1 m	1:6/4:PA
KA3600F:2	40.5 – 42	P, HC	PE	1 m	2:6/4:PA, 1:1/8"/2:PE
KA3600F:3	20 – 39.5	P		2 m	3:6/4:PA, 1:1/8"/2:PE
KA3600F:4	1.3 – 18	P		1 m	4:6/4:PA, 1:1/8"/2:PE
KA3510A:1	125 – 150	P		1 m	1:6/4:PA
KA3510A:2	110 - 124	P, F		1 m	3:6/4:PA
KA3510A:3	75 - 109	P		1 m	4:6/4:PA
KA3510A:4	51 - 74	P		1 m	5:6/4:PA
KA3510A:5	4.5 - 50	P		1 m	6:6/4:PA
KG0021A01:1	42.5 – 48.82	P, HC		1 m	1:6/4:ST, 1:1/8"/2:PE
KG0021A01:2	37 – 41.5	P		1 m	2:6/4:PA, 1:1/8"/2:PE
KG0021A01:3	35 - 36	P, C	HD	1 m	5:6/4:PA, 1:1/8"/2:PE
KG0021A01:4	19 - 34	P		1 m	6:6/4:PA, 1:1/8"/2:PE
KG0021A01:5	5 - 18	P		1 m	7:6/4:PA, 1:1/8"/2:PE
KG0048A01:1	49 – 54.69	P, HC		1 m	1:6/4:ST, 1:1/8"/2:PE
KG0048A01:2	34.8 – 48	P		1 m	2:6/4:PA, 1:1/8"/2:PE
KG0048A01:3	32.8 – 33.8	P, C	HD	1 m	5:6/4:PA, 1:1/8"/2:PE
KG0048A01:4	13 – 31.8	P		1 m	6:6/4:PA, 1:1/8"/2:PE
KG0048A01:5	5 - 12	P		1 m	7:6/4:PA, 1:1/8"/2:PE

Type of section:

- P Pressure measurement
- C Circulation possible
- HC Hydrochemistry sampling
- F Flow

Materials:

- PA Polyamide
- ST Steel
- PE PEEK
- HD HD1000 (High Density Polyethylene)

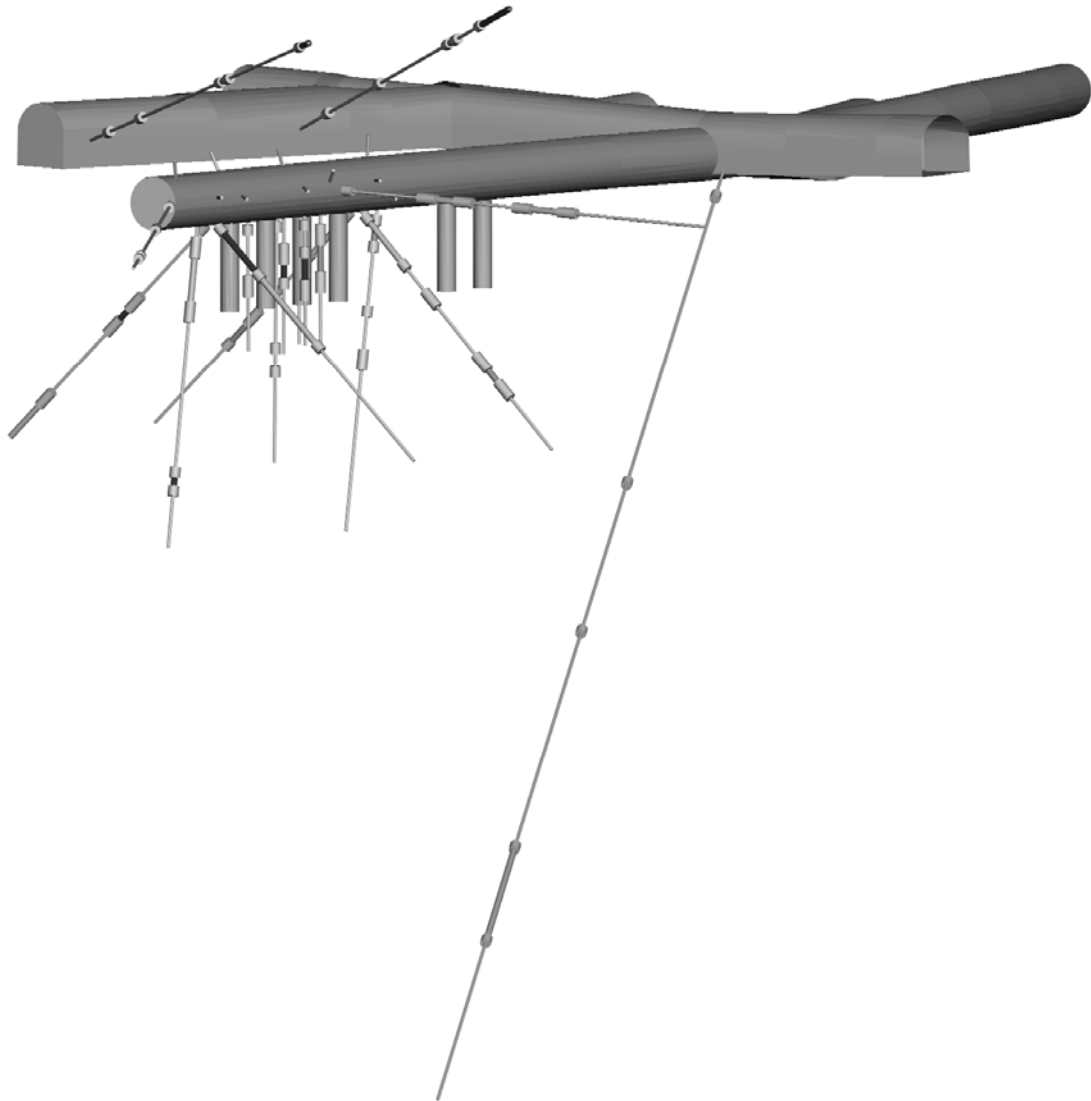

Figure 1. View of the drilled core holes in the Prototype Repository Section I. The length from the I-tunnel to the end of the TBM-tunnel is 90 m. The diameter of the TBM tunnel is 5 m and the diameter of the deposition holes is 1.75 m. The depth of the deposition holes is 8.37 m in the centre and 8.15 m along the deposition hole wall. The diameter of the core holes is 76 mm except for the short core holes in the roof of the TBM tunnel that have a diameter of 56 mm. The monitoring boreholes used in the presentation in this report are located in the inner part of the tunnel surrounding the area with the four innermost canister holes. Also included are two holes drilled from the G-tunnel and the long hole KA3510A drilled from the main tunnel.

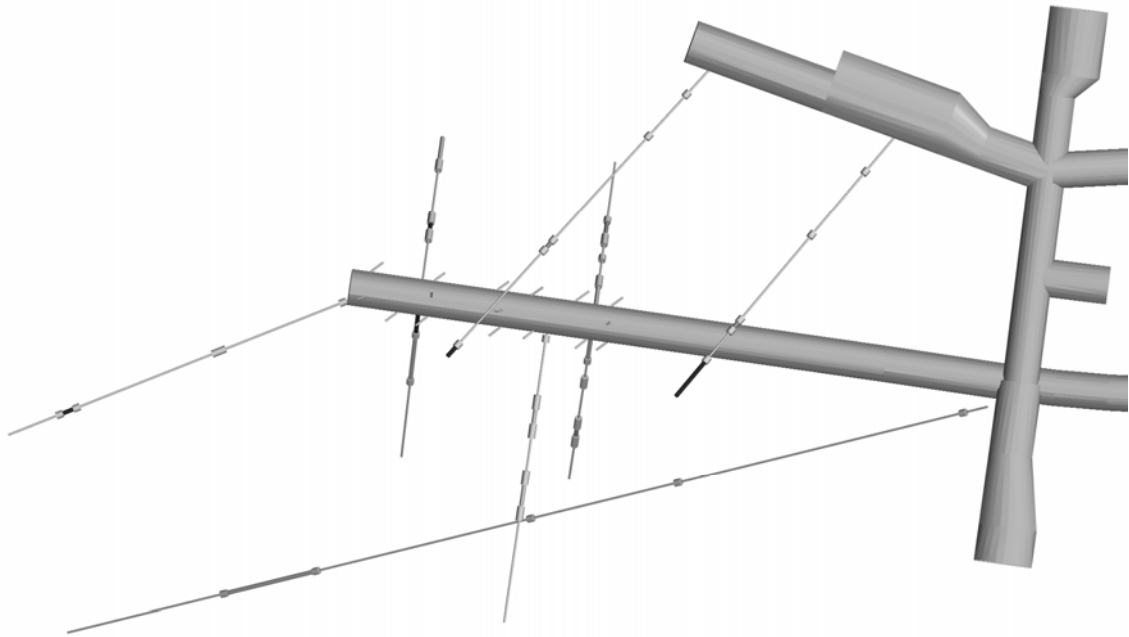

Figure 2. Overview of Sektion I in Prototype Repository.

Instrumentation with hydraulic packers in Section II

Fifteen boreholes are equipped with hydraulically expanded packers of one meters length to seal off at most five sections in one borehole. In ten of these boreholes one section also is instrumented with hydro-mechanical equipment adapted to measure small deformations in the solid rock and over selected fractures. Another borehole in the G-tunnel is instrumented with HM equipment as a reference. The borehole was drilled in the north tunnel wall and is not expected to be influenced by the stress changes around the Prototype tunnel.

Table 2 Instrumentation configuration in Section II. “Lead-through”: pipes between the packers.

Borehole:sec	Sec. length (m)	Type of section	Tubes/pipes (no:diameter:type)
KA3539G:1	18.6 – 30	P	1:4/2:PA, 1:6/4:PA
KA3539G:2	15.85 – 17.6	P, HM, C	2:4/2:PA, 3:6/4:PA, 3:4/2:ST, 2:8/6:ST
KA3539G:3	10 – 14.85	P, F	3:4/2:PA, 4:6/4:PA, 3:4/2:ST, 2:8/6:ST
KA3539G:4	4 – 9	P	4:4/2:PA, 4:6/4:PA, 3:4/2:ST, 2:8/6:ST
KA3542G01:1	27 – 30	P	1:4/2:PA, 1:6/4:PA
KA3542G01:2	21.3 – 26	P	2:4/2:PA, 1:6/4:PA
KA3542G01:3	18.6 – 20.3	P, HM,C	3:4/2:PA, 3:6/4:PA, 3:4/2:ST, 2:8/6:ST
KA3542G01:4	10.5 – 17.6	P	4:4/2:PA, 3:6/4:PA, 3:4/2:ST, 2:8/6:ST
KA3542G01:5	3.5 – 9.5	P	5:4/2:PA, 3:6/4:PA, 3:4/2:ST, 2:8/6:ST
KA3542G02:1	28.2 – 30.01	P	1:4/2:PA, 1:6/4:PA
KA3542G02:2	25.6 – 27.2	P, HM, C	2:4/2:PA, 3:6/4:PA, 3:4/2:ST, 2:8/6:ST
KA3542G02:3	21.5 – 24.6	P	3:4/2:PA, 3:6/4:PA, 3:4/2:ST, 2:8/6:ST
KA3542G02:4	9 – 20.5	P	4:4/2:PA, 3:6/4:PA, 3:4/2:ST, 2:8/6:ST
KA3542G02:5	2 – 8	P, F	5:4/2:PA, 4:6/4:PA, 3:4/2:ST, 2:8/6:ST
KA3544G01:1	11.65 – 12	P	1:4/2:ST, 1:6/4:ST
KA3544G01:2	8.9 – 10.65	P, HM, C	5:4/2:ST, 3:6/4:ST, 2:8/6:ST
KA3544G01:3	3.5 – 7.9	P	6:4/2:ST, 3:6/4:ST, 2:8/6:ST
KA3546G01:1	9.3 – 12	P	1:4/2:ST, 1:6/4:ST
KA3546G01:2	6.75 – 8.3	P, HM, C	5:4/2:ST, 3:6/4:ST, 2:8/6:ST
KA3546G01:3	1.5 – 5.75	P	6:4/2:ST, 3:6/4:ST, 2:8/6:ST
KA3548A01:1	21.5 – 30	P	1:4/2:PA, 1:6/4:PA
KA3548A01:2	11.75 – 20.5	P, F	2:4/2:PA, 2:6/4:PA
KA3548A01:3	8.8 – 10.75	P, HM, C	3:4/2:PA, 4:6/4:PA, 3:4/2:ST, 2:8/6:ST
KA3548A01:4	3 – 7.8	P	4:4/2:PA, 4:6/4:PA, 3:4/2:ST, 2:8/6:ST
KA3548G01:1	6-12	P	2:6/4:PA
KA3548G01:2	2-5	P	3:6/4:PA
KA3550G01:1	8.3 – 12.03	P	1:4/2:ST, 1:6/4:ST
KA3550G01:2	5.2 – 7.3	P, HM, C	5:4/2:ST, 3:6/4:ST, 2:8/6:ST
KA3550G01:3	1.8 – 4.2	P	6:4/2:ST, 3:6/4:ST, 2:8/6:ST
KA3550G05:1	1.5 – 3	P	1:4/2:ST, 1:6/4:ST
KA3551G05:1	1.5 – 3.1	P	1:4/2:ST, 1:6/4:ST
KA3552G01:1	7.05 – 12	P	1:4/2:ST, 1:6/4:ST
KA3552G01:2	4.35 – 6.05	P, HM, C	5:4/2:ST, 3:6/4:ST, 2:8/6:ST
KA3552G01:3	1.5 – 3.35	P	6:4/2:ST, 3:6/4:ST, 2:8/6:ST
KA3554G01:1	25.15 – 30.01	P	1:4/2:PA, 1:6/4:PA
KA3554G01:2	22.6 – 24.15	P, HM, C	2:4/2:PA, 3:6/4:PA, 3:4/2:ST, 2:8/6:ST
KA3554G01:3	14 – 21.6	P	3:4/2:PA, 3:6/4:PA, 3:4/2:ST, 2:8/6:ST
KA3554G01:4	5 – 13	P	4:4/2:PA, 3:6/4:PA, 3:4/2:ST, 2:8/6:ST

Borehole:sec	Sec. length (m)	Type of section	Tubes/pipes (no:diameter:type)
KA3554G01:5	1.5 – 4	P	5:4/2:PA, 3:6/4:PA, 3:4/2:ST, 2:8/6:ST
KA3554G02:1	22 – 30.01	P	1:4/2:PA, 1:6/4:PA
KA3554G02:2	15.9 – 21	P	2:4/2:PA, 1:6/4:PA
KA3554G02:3	13.2 – 14.9	P	3:4/2:PA, 1:6/4:PA
KA3554G02:4	10.5 – 12.2	P, HM, C	4:4/2:PA, 3:6/4:PA, 3:4/2:ST, 2:8/6:ST
KA3554G02:5	1.5 – 9.5	P	5:4/2:PA, 3:6/4:PA, 3:4/2:ST, 2:8/6:ST
KA3557G:1	15 – 30.04	P	1:4/2:PA, 1:6/4:PA
KA3557G:2	1.5 – 14	P	2:4/2:PA, 1:6/4:PA
KG0010B01:1	2.8 – 4.35	HM	3:4/2:ST, 2:8/6:ST

Type of section:

P Pressure measurement

C Circulation possible

HM Hydro-mechanical measurements

Materials:

PA Polyamide tube

ST Stainless steel pipe

F Flow

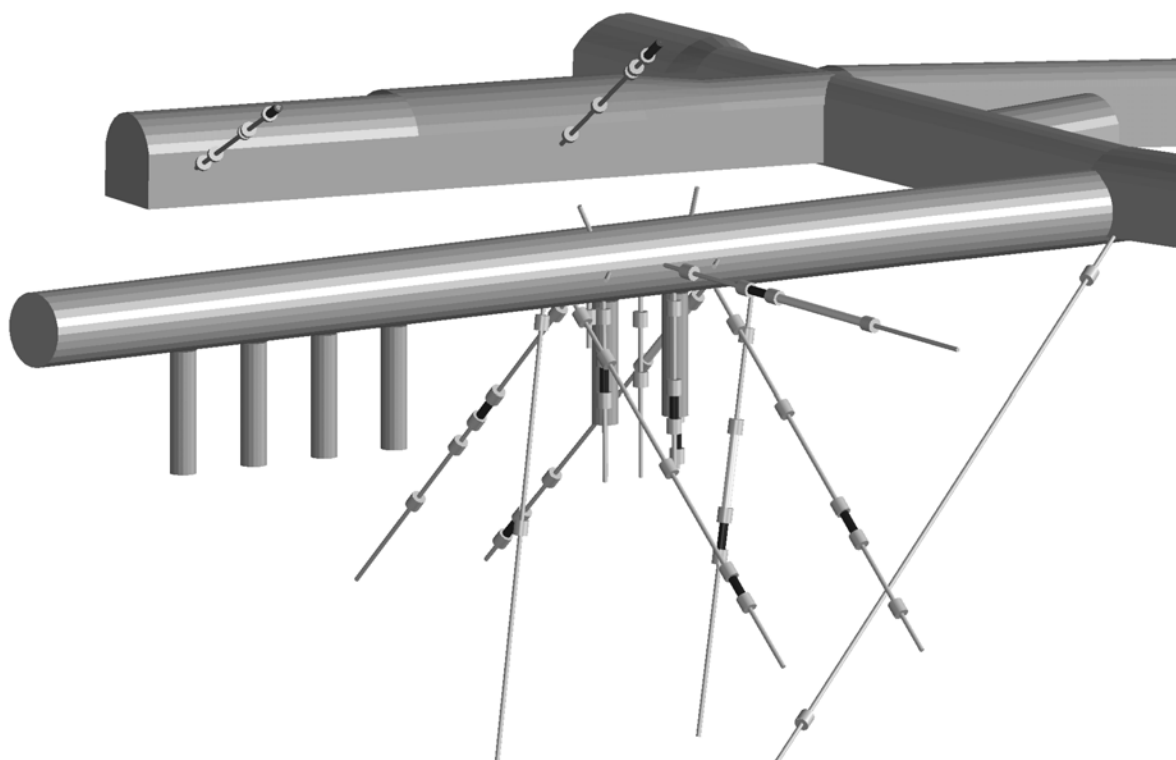

Figure 3. View of the drilled core holes in the Prototype Repository Section II. The length from the I-tunnel to the end of the TBM-tunnel is 90 m. The diameter of the TBM tunnel is 5 m and the diameter of the deposition holes is 1.75 m. The depth of the deposition holes is 8.37 m in the centre and 8.15 m along the deposition hole wall. The diameter of the core holes is 76 mm except for the short core holes in the roof of the TBM tunnel that have a diameter of 56 mm. The monitoring boreholes used in the presentation in this report are located in the inner part of the tunnel surrounding the area with the four innermost canister holes. Also included are two holes drilled from the G-tunnel and the long hole KA3510A drilled from the main tunnel.

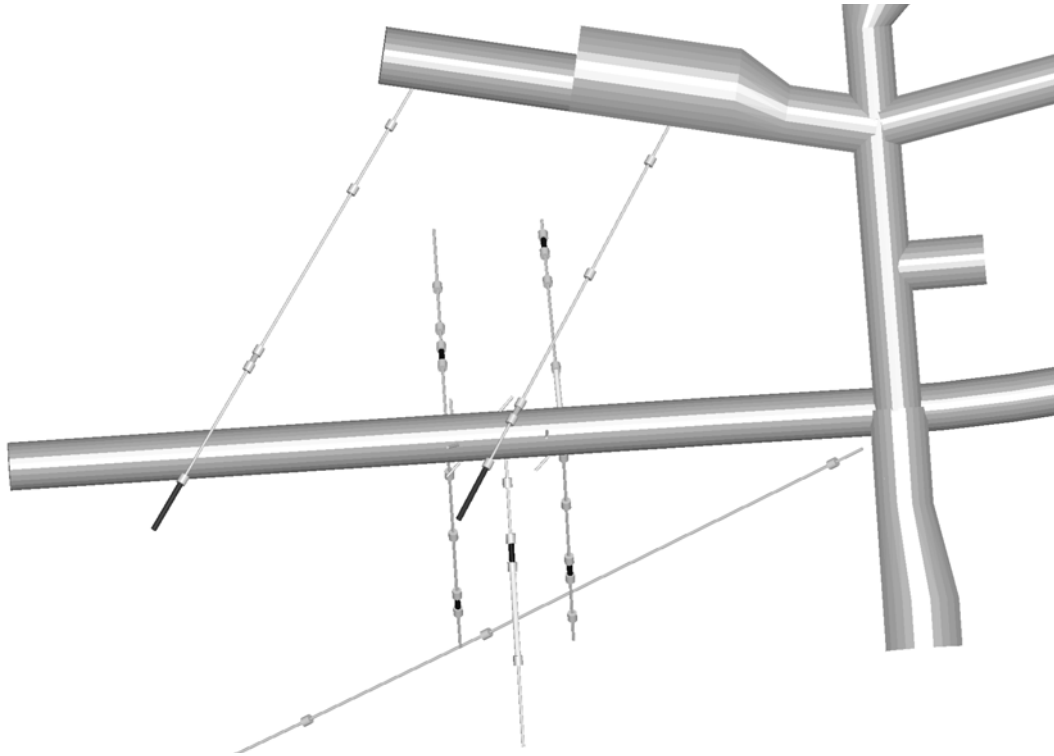

Figure 4. Overview of Sektion II in Prototype Repository.

Instrumentation with mechanical packers

Twenty-two short boreholes (2 m) in the tunnel roof and walls are equipped with mechanical packers, see *Table 3*. After insertion into the hole, the pulling of a nut on the centre pipe expanded the packer. Since these holes are directed upwards, the de-airation required an extra lead-through connected to a tube ending in the innermost part of the borehole. The de-airation was made during the backfilling and in boreholes with very little flow the de-airation was made by filling water through the outer tube.

Table 3. Boreholes instrumented with mechanical packers
 (“Inclination”: inclination of the borehole).

Borehole	Borehole length (m)	Inclination (°)
KA3543A01	2.06	-0.8
KA3543I01	2.06	70.5
KA3548D01	2.06	2.7
KA3552A01	2.06	-2.8
KA3552H01	2.1	58.2
KA3553B01	2.02	-37.7
KA3563A01	2.06	-7.7
KA3563D01	approx. 2	2.8
KA3563I01	2.15	73
KA3566C01	2.1	3.5
KA3568D01	2.3	-2.3
KA3573C01	2.05	34.9
KA3574D01	2.05	12.6
KA3578C01	2.09	-5.4
KA3578H01	1.9	59.1
KA3579D01	2	-1
KA3588C01	2.04	-4
KA3588D01	1.9	-1.8
KA3588I01	1.96	65.6
KA3592C01	2.1	4.4
KA3597D01	2.22	3.1
KA3597H01	2.06	55.1

Calibration intervals

Recalibration of pressure transducers are made a couple of times every year.

Pressure measurements

In this section pressure measurements of all monitored holes in the Prototype repository is shown in plots below. The pressure values plotted are daily mean values. The definition of day 0 is the day the heating of canister 1 started, i.e. 2001-09-17. In Table 4 the dates of the starting of the heaters in all canisters are presented.

Table 4 Starting of heaters in canisters.

Canister in deposition hole	Date
1 (DA3587G)	2001-09-17
2 (DA3581G)	2001-09-24
3 (DA3575G)	2001-11-10
4 (DA3569G)	2001-11-24
5 (DA3551G)	2003-05-08
6 (DA3545G)	2003-05-23

The position of pressure measurement is indicated for all observation sections.

In general sections close to the prototype rock wall indicate lower pressure head than further away from the prototype.

In the longer holes the section closest to the wall have a lower head than sections deeper into the rockmass.

A pressure drop 2002-05-07 for most of the observation sections are shown in the plots. The most major pressure change happens in the lowest section of KA3566G02 (approx. 70 m) but are also clearly visible for section 2-4 of the same borehole. The pressure recovered during the evening of 2002-12-02. The cause for the pressure change is unknown.

Several sections have had a slight decreasing trend since the summer of 2002. This trend was in most cases discontinued after 2004-11-01 when the draining of Section I was closed down.

The instrumentation of boreholes in Section II started 2002-11-06 and continued until the beginning of December 2002. Several sections indicate a pressure drop around 2002-11-11 which probably is caused by the installation work.

The sections of KA3510A show a drop of pressure during the the first week of December 2002. The pressure is quickly re-established. Probably the cause for this was the on-going monitoring work in Section II.

During the period 2003-05-08 until 2003-05-15 a total of 19 hydraulic tests (TC 1) were done in several of the boreholes in Section I and II. The tests caused groundwater pressure interference in the whole of the prototype repository area. Since the tests were mostly short-time tests it is only shown in some of the borehole section plots.

During the summer 2003 (2003-07-13 to 2003-08-05) no pressure data was recorded. In some of the long boreholes inclined to the south of the prototype show a pressure drop in mid-August.

The packers in KA3550G01 were deflated 2003-08-18 and has not been possible to re-inflate again. The reason is probably a tube leakage.

Hydraulic single hole tests were done in nine boreholes during 2003-10-21 – 10-23 (TC 2). The tests caused groundwater pressure interference in the whole of the prototype repository area. Since the tests were mostly short-time tests it is only shown in some of the borehole section plots.

The packers in five boreholes were deflated around Oct 30 – Nov 1, 2003. This was probably generated by a tube leakage which in its turn emptied the water in the pressure vessel and finally emptied the gas tube connected to it. The boreholes whose packers were deflated were KA3542G01, KA3542G02, KA3544G01 and KA3548A01. It was possible to inflate the packers in three of the four boreholes on 2003-11-10. It was not possible to restore the status of KA3544G01. This pressure drop is observed in several other borehole observation sections.

Hydraulic single hole tests were done in eight boreholes during 2004-02-02 – 02-04 (TC 3). The tests caused groundwater pressure interference in the whole of the prototype repository area. Since the tests were mostly short-time tests it is only shown in some of the borehole section plots.

A pressure drop of around 700 kPa in KA3566G01:4 is observed 2004-02-25. It remained so for some weeks before recovering, but dropped again in May and remains that way at the end of the month. This pattern was observed in this section during the spring 2003. The following investigation showed a faulty data-scan coupling (corrosion) which were replaced 2004-08-10.

Hydraulic single hole tests were done in eight boreholes during 2004-08-11 – 08-18 (TC 4). The tests caused groundwater pressure interference in the whole of the prototype repository area. Since the tests were mostly short-time tests it is only shown in some of the borehole section plots.

During the period 2005-01-19 until 2005-01-28 a total of 26 hydraulic tests (TC 5) were done in several of the boreholes in Section I and II. The tests caused groundwater pressure interference in the whole of the prototype repository area. Since the tests were mostly short-time tests it is only shown in some of the borehole section plots.

During week 36, starting 2005-09-05, several boreholes have a rather sudden drop in pressure which does not recover immediately. The reason is not known yet.

During week 39, starting 2005-10-01, pressure in KA3557G decreased rather suddenly. This was due to an empty gas pressure vessel, which has been replaced by now (January 2006).

Hydraulic single hole tests were done in eight boreholes during 2005-11-28 – 12-02 (TC 6). A total of 17 tests were done. The tests caused groundwater pressure interference in the whole of the prototype repository area. Since the tests were mostly short-time tests it is only shown in some of the borehole section plots.

In KA3573A the pressure in section 3 suddenly decreases around 200 kPa 2006-02-12/13. This is the initial phase as it turned out later, see below, of the total pressure loss of that section.

In KA3566G01 sections 2 and 3, and 4 and 5 respectively are short-cut from 2006-03-03. The reason is not known.

A pressure drop in several borehole sections on the south side of the prototype repository is observed from approximately 2006-04-18. At the same time the drainage from Section 1 increases from 1.5 to 9 L/min. Section KA3573A:3 which loses most of its pressure head is believed to lead groundwater, together with sections KA3573A:2 & 4, into the Section 1 backfill. In earlier investigations this borehole had flowrates over 50 L/min (*Rhén, Forsmark, 2001*). The following borehole/sections are affected by this pressure drop event: KA3510A:3-5, KA3539G, KA3542G01, KA3548A01, KA3554G01, KA3566G01:1, KA3573A:2-4, KA3590G01:1-2, KG0021A01:1-4 and KG0048A01:1-4. The pressure decrease is probably a result of a leaking tube or a tube coupling from KA3573A:3. The pressure in KA3573A:3 is now at the same level as the pressure in the backfill (around 500 kPa).

The pressure drop in KA3557G in July 2006 is due to HMS maintenance work.

Hydraulic single hole tests were done in eight boreholes during 2006-09-25 – 09-29 (TC 7). A total of 17 tests were done. The tests caused groundwater pressure interference in the whole of the prototype repository area. Since the tests were mostly short-time tests it is only shown in some of the borehole section plots.

In November/December 2006, dilution measurements were made in KA3539G:2, KA3542G01:3, KA3542G02:2, KA3546G01:2, KA3548A01:3, KA3552G01:2, KA3554G01:2, KA3554G02:4, KA3563G:4, KA3566G01:2, KA3566G02:2, KA3572G01:2, KA3574G01:3, KG0021A01:3 and KG0048A01:3.

The work with excavating a new tunnel niche from I-niche, for sealing experiments, commenced in March 2007. The project is called “Sealing of Tunnel at Great Depth”. Since it is situated rather close to the Prototype Repository it is expected to influence the pressure levels around the prototype.

During the period March – December 2007, the drilling and testing of three boreholes in niche I, KI0010B01, KI0014B01 and KI0016B01 causes major pressure head fluctuations in most of the observation sections in the prototype repository. The overall groundwater head level decreases during this period but late in the period seems to recover. The new boreholes are drilled within the project “Sealing of Tunnel at Great Depth”.

The pressure transducers in KA3510A were taken out of operation 2007-08-20. The reason is the on-going tunnel construction works in the I-niche. They were taken in operation again in August 2008.

KA3566G02 transducers does not seem to work properly since the start of the “Sealing of Tunnel at Great Depth” project in the summer of 2007.

Hydraulic single hole tests were done in eight boreholes during 2007-10-15 – 10-19 (TC 8). A total of 17 tests were done. The tests caused some groundwater pressure interference in the prototype repository area.

Fan grouting have been done within the project “Sealing of Tunnel at Great Depth” during several periods November 2007 until May 2008. Especially the fan grouting campaign 2007-11-26 to 2007-11-29 result in pressure level increase in several of the boreholes in the prototype repository including KA3542G01, KA3542G02, KA3548A01, KA3554G01 and KA3554G02.

Hydraulic single hole tests were done in eight boreholes during 2008-10-20 – 10-24 (TC 9). A total of 17 tests were done. During testing of KA3552G01 a sudden flowrate increase occurred together with a pressure increase. This was caused by a probable tube failure. The packers are now deflated and the hole can not be used further on. The pressure increase is noticed in KA3542G01, KA3543A01, KA3548D01, KA3544G01, KA3546G01, KA3548G01, KA3550G01 and KA3553B01.

In Table 5 the pressure sensor status 2008-12-01 is estimated based on pressure head data. It is to be noted as an estimation only.

Table 5. Apparent pressure sensor status.

Borehole:sec	Secup (m)	Seclow (m)	Pressure status 2008-12-01	Comment
KA3510A:1	125.00	150.00	OK	
KA3510A:2	110.00	124.00	OK	
KA3510A:3	75.00	109.00	OK	
KA3510A:4	51.00	74.00	OK	
KA3510A:5	4.50	50.00	OK	
KA3539G:1	18.60	30.00	OK	
KA3539G:2	15.85	17.60	OK	
KA3539G:3	10.00	14.85	OK	
KA3539G:4	4.00	9.00	OK	
KA3542G01:1	27.00	30.00	OK	
KA3542G01:2	21.30	26.00	OK	
KA3542G01:3	18.60	20.30	OK	
KA3542G01:4	10.50	17.60	OK	
KA3542G01:5	3.50	9.50	OK	
KA3542G02:1	28.20	30.01	OK	
KA3542G02:2	25.60	27.20	OK	
KA3542G02:3	21.50	24.60	OK	
KA3542G02:4	9.00	20.50	OK	
KA3542G02:5	2.00	8.00	OK	
KA3543A01:1	0.65	2.06	OK	
KA3543I01:1	0.65	2.06	Not OK?	Air in borehole section?
KA3544G01:1	11.65	12.00	Not OK	Shortcut between sections.
KA3544G01:2	8.90	10.65	Not OK	Shortcut between sections.
KA3544G01:3	3.50	7.90	Not OK	Shortcut between sections.
KA3546G01:1	9.30	12.00	OK	
KA3546G01:2	6.75	8.30	OK	
KA3546G01:3	1.50	5.75	OK	
KA3548A01:1	21.50	30.00	OK	
KA3548A01:2	11.75	20.50	OK	
KA3548A01:3	8.80	10.75	OK	
KA3548A01:4	3.00	7.80	OK	
KA3548D01:1	0.65	2.06	OK	
KA3548G01:1	6.00	12.00	OK	
KA3548G01:2	2.00	5.00	OK	
KA3550G01:1	8.30	12.03	Not OK	Shortcut between sections.
KA3550G01:2	5.20	7.30	Not OK	Shortcut between sections.
KA3550G01:3	1.80	4.20	Not OK	Shortcut between sections.
KA3550G05:1	1.50	3.00	OK	
KA3551G05:1	1.50	3.10	OK	
KA3552A01:1	0.65	2.06	Not OK?	Air in borehole section?
KA3552G01:1	7.05	12.00	Not OK	Probable tube failure in section 2
KA3552G01:2	4.35	6.05	Not OK	Probable tube failure in section 2
KA3552G01:3	1.50	3.35	Not OK	Probable tube failure in section 2
KA3552H01:1	0.65	2.10	Not OK?	Air in borehole section?
KA3553B01:1	0.65	2.02	OK	
KA3554G01:1	25.15	30.01	OK	
KA3554G01:2	22.60	24.15	OK	
KA3554G01:3	14.00	21.60	OK	
KA3554G01:4	5.00	13.00	OK	

Borehole:sec	Secup (m)	Seclow (m)	Pressure status 2008-12-01	Comment
KA3554G01:5	1.50	4.00	Not OK	Unrealistic values after 2008-03-20
KA3554G02:1	22.00	30.01	OK	
KA3554G02:2	15.90	21.00	OK	
KA3554G02:3	13.20	14.90	OK	
KA3554G02:4	10.50	12.20	OK	
KA3554G02:5	1.50	9.50	Not OK	Unrealistic values after 2006-07-11
KA3557G:1	15.00	30.04	OK	
KA3557G:2	1.50	14.00	Not OK	Unrealistic values after 2008-11-01
KA3563A01:1	0.65	2.06	OK	
KA3563D01:1	0.65	2.01	OK	
KA3563G:1	15.00	30.01	OK	
KA3563G:2	10.00	13.00	OK	
KA3563G:3	4.00	8.00	OK	
KA3563G:4	1.50	3.00	OK	
KA3563I01:1	0.65	2.15	OK	
KA3566C01:1	0.65	2.1	OK	
KA3566G01:1	23.50	30.01	OK	
KA3566G01:2	20.00	21.50	OK	
KA3566G01:3	12.00	18.00	OK	
KA3566G01:4	7.30	10.00	Not OK	Shortcut between sections 4 and 5
KA3566G01:5	1.50	6.30	Not OK	Shortcut between sections 4 and 5
KA3566G02:1	19.00	30.10	Not OK	Pressure drop May 2007. All sections shortcut!
KA3566G02:2	16.00	18.00	Not OK	Pressure drop May 2007. All sections shortcut!
KA3566G02:3	12.00	14.00	Not OK	Pressure drop May 2007. All sections shortcut!
KA3566G02:4	8.00	11.00	Not OK	Pressure drop May 2007. All sections shortcut!
KA3566G02:5	1.30	6.00	Not OK	Pressure drop May 2007. All sections shortcut!
KA3568D01:1	0.65	2.30	OK	
KA3572G01:1	7.30	12.03	OK	
KA3572G01:2	2.70	5.30	OK	
KA3573A:1	26.00	40.07	Not OK	Probable tube failure in section 3
KA3573A:2	21.00	24.00	Not OK	Probable tube failure in section 3
KA3573A:3	14.50	19.00	Not OK	Probable tube or tube coupling failure
KA3573A:4	10.50	12.50	Not OK	Probable tube failure in section 3
KA3573A:5	1.30	8.50	Not OK	Probable tube failure in section 3
KA3573C01:1	0.65	2.05	OK	
KA3574D01:1	0.65	2.05	OK	
KA3574G01:1	8.00	12.03	OK	
KA3574G01:2	5.10	7.00	Not OK?	Sudden pressure increase 2008-09-01
KA3574G01:3	1.80	4.10	OK	
KA3576G01:1	8.00	12.01	OK	
KA3576G01:2	4.00	6.00	OK	
KA3576G01:3	1.30	3.00	OK	
KA3578C01:1	0.65	2.09	OK	
KA3578G01:1	6.50	12.58	OK	
KA3578G01:2	4.30	5.50	OK	
KA3578H01:1	0.65	1.90	OK	
KA3579D01:1	0.65	2.00	Not OK	Air in borehole section?

Borehole:sec	Secup (m)	Seclow (m)	Pressure status 2008-12-01	Comment
KA3579G:1	14.70	22.65	OK	
KA3579G:2	12.50	13.70	OK	
KA3579G:3	2.30	11.50	Not OK	Air in borehole section?
KA3584G01:1	7.00	12.00	OK	
KA3584G01:2	1.30	5.00	OK	
KA3588C01:1	0.65	2.04	OK	
KA3588D01:1	0.65	1.90	OK	
KA3588I01:1	0.65	1.96	OK	
KA3590G01:1	16.00	30.00	Not OK?	Shortcut between sections.
KA3590G01:2	7.00	15.00	Not OK?	Shortcut between sections.
KA3590G01:3	1.30	6.00	OK	
KA3590G02:1	25.50	30.01	OK	
KA3590G02:2	15.20	23.50	OK	
KA3590G02:3	11.90	13.20	OK	
KA3590G02:4	1.30	9.90	OK	
KA3592C01:1	0.65	2.01	Not OK?	Air in borehole section?
KA3593G:1	25.20	30.02	Not OK	Unprobable low pressure in section
KA3593G:2	23.50	24.20	OK	
KA3593G:3	9.00	22.50	OK	
KA3593G:4	3.00	7.00	OK	
KA3597D01:1	0.65	2.22	Not OK?	Air in borehole section?
KA3597H01:1	0.65	2.06	OK	
KA3600F:1	43.00	50.10	OK	
KA3600F:2	40.50	42.00	OK	
KA3600F:3	20.00	39.50	OK	
KA3600F:4	1.30	18.00	OK	
KG0021A01:1	42.50	48.82	OK	
KG0021A01:2	37.00	41.50	OK	
KG0021A01:3	35.00	36.00	OK	
KG0021A01:4	19.00	34.00	OK	
KG0021A01:5	5.00	18.00	OK	
KG0048A01:1	49.00	54.69	OK	
KG0048A01:2	34.8	48	OK	
KG0048A01:3	32.80	33.80	OK	
KG0048A01:4	13.00	31.80	OK	
KG0048A01:5	5.00	12.00	OK	

Drainage of Section I

The drainage system in Section I was shut down 2004-11-01. It resulted in a major pressure increase in most borehole sections close to the prototype tunnel. The pressure increased until 2004-12-06.

The drained water amount was approximately 2.5 L/min. The flowrate of weir MG0004G decreased accordingly with the same order of magnitude after November 1.

The drainage system was re-opened 2004-12-06 due to electrical problems with the canister heaters. It is still open (2008-06-01). The pressure in most borehole sections within Section I decreased rapidly again after the re-opening while the pressures in Section II decreased more slowly.

In mid-April 2006 the flowrate from Section 1 rather suddenly increases to 9 L/min, while pressure decreases in several boreholes on the south side of the prototype. This is a result of tube failure in borehole section KA3573A:3.

Packer functionality status in Section II

The packers are of the type PU53 or PU72. All packers have an inflation length of one meter and the minimum and maximum packer expansion pressure is 6.5 bar and 65 bar respectively. They are expanded by means of water, pressurised by nitrogen gas in a pressure vessel. A regulator controls the magnitude of the inflation pressure. The stainless steel pressure vessel is connected to the packers by a high-pressure 6/4-mm polyamide tube, type Tecalan. A check valve unit with a manometer is mounted on the packer inflation line. In order to avoid accidental deflation the check valve unit also includes a stop valve.

In Table 6 below are listed the borehole packers that have ceased to function for some reason.

Table 6. Packer functionality status in Section II.

Packer tube label	Borehole	Status 2008-12-01	Date of inflation pressure failure	Date of re-inflation pressure
XRA1100	KA3539G	OK		
XRA1200	KA3542G01	OK	2003-10-30	2003-11-10
XRA1300	KA3542G02	OK	2003-10-30	2003-11-10
XRA1600	KA3544G01	Not functioning due to tube leakage	2003-10-30	–
XRA1700	KA3546G01	OK		
XRA1800	KA3548A01	OK	2003-10-30	2003-11-10
XRA2000	KA3548G01	OK		
XRA2100	KA3550G01	Not functioning due to tube leakage	2003-08-18	–
XRA2200	KA3550G05	OK		
XRA2300	KA3551G05	OK		
XRA2500	KA3552G01	Not functioning due to tube leakage	2008-10-23	–
XRA2800	KA3554G01	OK		
XRA2900	KA3554G02	OK		
XRA3000	KA3557G	OK	ca 2005-10-01	Jan 2006

Deformation measurements in Section II

Deformation measurements of fractures in borehole sections with Hydro-Mechanical anchors in Section II are on-going but no results are available yet.

Flow measurements

Earlier estimations and measurements of inleaking ground water amounts to the tunnel system are presented in (*Forsmark T, Rhén I, 2001*) and (*Rhén I, Forsmark T, 2001*).

Data from eight flow weirs are presented in this data report.

A weir at the tunnel G opening measures the inleaking amounts from this tunnel. The weir was taken in operation in January 2002-01-21 and is named MG0004G. The water from MG0004G is led to PG5. The pumped water amounts from Section I mentioned above was prior to to November 1, 2004, when the drainage of Section I was closed down, included in the rates from this weir station which is clearly shown in the diagram below.

The weir MF0061G halfway down tunnel F measures today the inleaking amounts from the first half of tunnel F, see plot of this weir. Earlier, until autumn 2001, inleaking water from tunnel G was led to tunnel F and weir MF0061G thereby to some extent explaining the high flowrate during that period. The inleaking water in tunnel J+ is included in the flowrate of MF0061G.

The weir MA3426G measures the flow rates from the south part of tunnel J and tunnel A chainage 3426 – 3514 m. Until December 2003 the inleaking amounts from tunnel section 3515 – 3600 was included in the presented flowrate. The inleaking water in tunnel I is included in this weir's flowrate.

In December 2003 three new flow measurement weirs were constructed in the A-tunnel outside Section II plug. They are called MA3515G, MA3525G and MA3535G (in operation 2003-12-10). The water from these three weirs is led to MA3426G. Continuous measurement is done since the spring of 2004. Manual measurements done in december 2003 show a flowrate for MA3515G of 0.175 – 0.19 L/min, for MA3525G of 1.15 – 1.25 L/min and for MA3535G of 0.38 – 0.45 L/min. The increase of flow during October 2004 was caused by yet unknown causes, but it is believed that the final grouting that was done around Plug 2 October 8, 2004 is the cause to it. The flow rates have now decreased once again.

Two weirs have, during the winter 2004/2005, been constructed inside niches I and J+. They are called MI0008G (in operation 2005-01-20) and MJ0033G (in operation 2005-01-20) respectively. The water from MI0008G is led to MA3426G. The water from MJ0033G is led to MF0061G. MI0008G is included in the continuously measurement program (HMS) while MJ0033G is measured manually approximately every fortnight. The readings from MI0008G have however not been correct since August 2005 and therefor no readings are presented since then. Manual readings will be made in the future. A manual reading 2006-06-26 shows a flow of 2.85 L/min which is within the same order of magnitude as the flow readings of the pre-August 2005 period.

MI0008G was plugged 2007-08-02 during the preparations of the construction of Tunnel S which will start inside niche I and the water is led to MA3426G.

The automatic registration of flow in MA3515G, MA3525G and MA3535G were cancelled during autumn 2007 due to the on-going tunnel construction work in the I-niche.

The flowrate in MA3426G have been extremely high during the period June until November 2007. This is due to that inleaking water from the new boreholes KI0010B01 and KI0016B01 together with the water previously measured in MI0008G is led to MA3426G. A single rate measurement 2007-10-18 gives a flowrate from KI0010B01 of 44 L/min and from KI0016B01 of 7 L/min.

As a probable result of the fan grouting campaign within the project “Fintätning av tunnel på stort djup” 2007-11-26 to 2007-11-29 the flowrate in MA3426G decrease considerably, from levels around 70 L/min down to levels of around 25 L/min.

Water sampling

Water sampling for chemical analysis have been done at several occasions, see *Table 7*. Each one of them may have an short-lived effect on the hydrostatic pressure in the rockmass. In some cases the flowing of a section continued for several days and the following pressure response is clearly shown in the subsequent plot.

Table 7. Water sampling dates in boreholes close to the Prototype Repository. Start and stop of times are for the flowing of the section.

Borehole	Start date/time	Stop date/time	Secup	Seclow	Section number
KA3600F	2001-10-15 10:30:00	2001-10-15 10:45:00	40.50	42.00	2
KA3600F	2001-10-15 10:45:00	2001-10-15 11:15:00	43.00	50.10	1
KA3573A	2002-09-24 10:30:00	2002-09-24 11:00:00	26.00	40.07	1
KA3573A	2002-09-24 11:40:00	2002-09-24 13:40:00	21.00	24.00	2
KA3600F	2002-09-25 11:00:00	2002-09-25 13:40:00	40.50	42.00	2
KA3600F	2002-09-25 11:25:00	2002-09-25 11:44:00	43.00	50.01	1
KA3510A	2002-12-12 08:30:00	2002-12-12 08:50:00	4.50	50.00	5
KA3510A	2002-12-12 08:30:00	2002-12-12 08:52:00	110.00	124.00	2
KA3510A	2002-12-12 10:30:00	2002-12-12 11:04:00	75.00	109.00	3
KA3539G	2003-05-23 09:48:00	2003-05-23 09:53:00	15.85	17.60	2
KA3542G01	2003-06-02 09:28:00	2003-06-02 09:54:00	18.60	20.30	3
KA3548A01	2003-06-02 09:57:00	2003-06-02 10:15:00	8.80	10.75	3
KG0048A01	2003-06-03 10:06:00	2003-06-03 10:12:00	32.80	33.80	3
KA3554G01	2003-06-03 10:31:00	2003-06-03 10:38:00	22.60	24.15	2
KA3542G02	2003-06-04 11:09:00	2003-06-04 12:49:00	25.60	27.20	2
KA3566G02	2003-06-04 12:30:00	2003-06-04 17:30:00	16.00	18.00	2
KG0021A01	2003-06-30 11:03:00	2003-06-30 11:09:00	35.00	36.00	3
KA3554G02	2003-06-30 15:23:00	2003-06-30 21:40:00	10.50	12.20	4
KA3600F	2003-07-03 13:51:00	2003-07-03 13:53:00	40.50	42.00	2
KA3572G01	2003-08-11 15:28:00	2003-08-28 15:00:00	2.70	5.30	2
KG0021A01	2003-09-18 09:40:00	2003-09-18 09:55:00	35.00	36.00	3
KG0048A01	2003-09-18 09:45:00	2003-09-18 09:55:00	32.80	33.80	3

Borehole	Start date/time	Stop date/time	Secup	Seclow	Section number
KA3542G01	2003-09-24 09:15:00	2003-09-24 09:30:00	18.60	20.30	3
KA3539G	2003-09-24 09:20:00	2003-09-24 09:35:00	15.85	17.60	2
KA3548A01	2003-09-24 09:30:00	2003-09-24 10:00:00	8.80	10.75	3
KA3554G01	2003-09-24 09:30:00	2003-09-24 10:00:00	22.60	24.15	2
KA3573A	2003-09-25 09:00:00	2003-09-25 10:00:00	26.00	40.07	1
KA3600F	2003-09-25 09:00:00	2003-09-25 09:45:00	43.00	50.10	1
KA3600F	2003-09-25 09:30:00	2003-09-25 10:00:00	40.50	42.00	2
KA3542G02	2003-09-26 11:20:00	2003-09-26 11:35:00	2.00	8.00	5
KA3573A	2003-09-29 10:20:00	2003-09-29 10:40:00	21.00	24.00	2
KA3566G02	2003-09-29 11:00:00	2003-09-29 13:50:00	16.00	18.00	2
KA3590G01	2003-09-30 09:00:00	2003-09-30 12:45:00	16.00	30.00	2
KA3539G	2004-02-16 10:50:00	2004-03-22 11:26:00	15.85	17.60	2
KA3548A01	2004-02-16 12:13:00	2004-02-16 12:31:00	8.80	10.75	3
KA3600F	2004-02-17 09:55:00	2004-02-17 10:11:00	40.50	42.00	2
KG0021A01	2004-02-17 10:27:00	2004-02-17 10:43:00	35.00	36.00	3
KA3539G	2004-02-17 11:30:00	2004-02-17 11:31:00	15.85	17.60	2
KG0048A01	2004-03-02 09:24:00	2004-03-02 09:40:00	32.80	33.80	3
KA3554G01	2004-03-02 10:04:00	2004-03-02 10:17:00	22.60	24.15	2
KA3542G02	2004-03-02 10:22:00	2004-03-02 13:15:00	2.80	8.00	5
KA3590G01	2004-03-03 21:36:00	2004-03-03 21:36:00	7.00	15.00	2
KA3572G01	2004-04-02 10:35:00	2004-04-07 10:15:00	2.70	5.30	2
KA3573A	2004-09-21 09:23:00	2004-09-22 09:54:00	26.00	40.07	1
KA3600F	2004-09-21 09:23:00	2004-09-22 10:03:00	43.00	50.10	1
KA3573A	2004-09-22 09:2200	2004-09-22 10:03:00	21.00	24.00	2
KA3600F	2004-09-22 09:18:00	2004-09-22 09:44:00	40.50	42.00	2
KA3542G01	2004-11-09 09:02:00	2004-11-09 10:11:00	18.60	20.30	3
KA3590G01	2004-11-15 11:16:00	2005-01-20 09:40:00	7.00	15.00	2
KA3554G02	2004-11-19 08:30:00	2004-11-22 16:50:00	10.50	12.20	4
KA3566G02	2004-11-19 08:30:00	2004-11-22 09:53:00	16.00	18.00	2
KA3566G02	2005-02-03 10:20	2005-03-10 14:00	16.00	18.00	2
KA3573A	2005-09-26 10:5800	2005-09-26 10:58:00	21.00	24.00	2
KA3600F	2005-09-26 10:42:00	2005-09-26 10:42:00	40.50	42.00	2
KA3510A	2005-10-03 09:24:00	2005-10-03 09:29:00	110.00	124.00	2
KA3573A	2005-10-05 10:30:00	2005-10-05 11:05:00	26.00	40.07	1
KA3600F	2005-10-07 09:20:00	2005-10-07 10:03:00	43.00	50.10	1
KA3510A	2005-10-07 12:15:00	2005-10-07 12:38:00	110.00	124.00	2
KA3554G01	2006-07-11 14:45:00	2006-07-12 14:45:00	22.60	24.15	2
KA3539G	2006-07-11 16:08:00	2006-07-11 18:35:00	15.85	17.60	2
KA3548A01	2006-07-11 17:35:00	2006-07-11 18:15:00	8.80	10.75	3
KA3600F	2006-07-12 09:37:00	2006-07-12 10:04:00			2
KA3572G01	2006-07-12 10:00:00	2006-07-18 15:35:00			2
KA3542G01	2006-07-12 10:52:00	2006-07-12 11:17:00	18.60	20.30	3
KG0021A01	2006-07-12 13:40:00	2006-07-12 14:29:00	35.00	36.00	3
KG0048A01	2006-07-12 14:42:00	2006-07-12 15:36:00	32.80	33.80	3
KA3590G01	2006-07-13 09:55:00	2006-07-13 16:00:00			2

Borehole	Start date/time	Stop date/time	Secup	Seclow	Section number
KA3566G02	2006-07-13 10:10:00	2006-07-13 19:25:00	16.00	18.00	2
KA3542G02	2006-07-13 14:37:00	2006-07-13 17:13:00	2.80	8.00	5
KA3554G02	2006-07-14 13:00:00	2006-07-17 16:30:00	10.50	12.20	4
KA3510A	2006-09-20 08:30:00	2006-09-20 08:35:00			
KA3542G02	2006-09-20 08:35:00	2006-09-20 08:40:00	25.60	27.20	2
KA3554G01	2006-09-20 08:35:00	2006-09-20 08:40:00	22.60	24.15	2
KA3573A	2006-10-02 10:15:00	2006-10-02 10:37:00	21.00	24.00	2
KA3600F	2006-10-02 09:50:00	2006-10-02 10:10:00	40.50	42.00	
KA3573A	2006-10-03 09:50:00	2006-10-03 10:17:00	26.00	40.07	1
KA3600F	2006-10-03 09:50:00	2006-10-03 10:13:00	43.00	51.10	
KA3554G01	2007-01-09 09:05:00	2007-01-09 09:57:00			
KA3600F	2007-01-09 14:32:00	2007-01-09 14:58:00			
KA3548A01	2007-01-09 15:03:00	2007-01-09 15:30:00			
KA3539G	2007-01-09 16:08:00	2007-01-09 16:53:00			
KA3572G01	2007-01-10 09:30:00	2007-01-16 10:33:00			
KA3542G01	2007-01-10 10:25:00	2007-01-10 10:49:00			
KA3566G02	2007-01-11 08:57:00	2007-01-11 16:35:00			
KA3590G01	2007-01-15 09:07:00	2007-01-15 14:37:00			
KA3554G02	2007-01-15 09:12:00	2007-01-16 10:39:00			
KA3542G02	2007-01-15 09:30:00	2007-01-15 11:13:00			
KA3542G01	2007-03-28 09:49:00	2007-03-29 10:13:00	18.60	20.30	3
KA3542G01	2007-03-29 09:15:00	2007-03-29 09:45:00	21.30	26.00	2
KG0021A01	2007-01-10 09:50:00	2007-01-10 10:21:00	35.00	36.00	3
KG0048A01	2007-01-10 13:59:00	2007-01-10 14:26:00	32.80	33.80	3

References

Forsmark T, Rhén I, 2001. Äspö HRL – Prototype repository. Hydrogeology - Injection test campaign 2. flow measurement of DA3575G01, groundwater salinity, ground water leakage into G-, I- and J-tunnels. SKB IPR-01-31.

Rhén I, Forsmark T, Torin L, 2001. Äspö HRL – Prototype repository. Hydrogeological, hydrochemical and temperature measurements in boreholes during the operation phase of the prototype repository. Tunnel section I. SKB IPR-01-32.

Rhén I, Forsmark T, Magnusson J, Alm P, 2003. Äspö HRL – Prototype repository. Hydrogeological, hydrochemical, hydromechanical and temperature measurements in boreholes during the operation phase of the prototype repository. Tunnel section II. SKB IPR-03-22.

Rhén I, Forsmark T, 2001. Äspö HRL – Prototype repository. Hydrogeology, Summary report of investigations before the operation phase. SKB IPR-01-65.

KA3510A PRESSURE HEAD

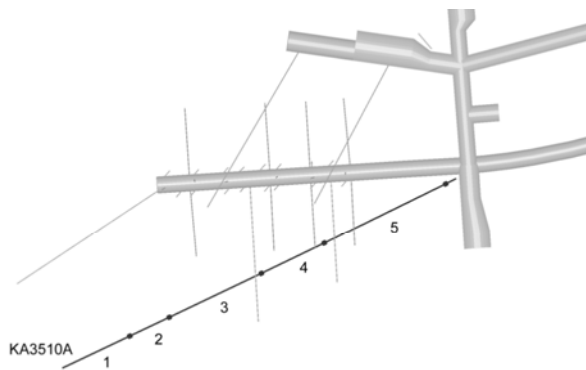
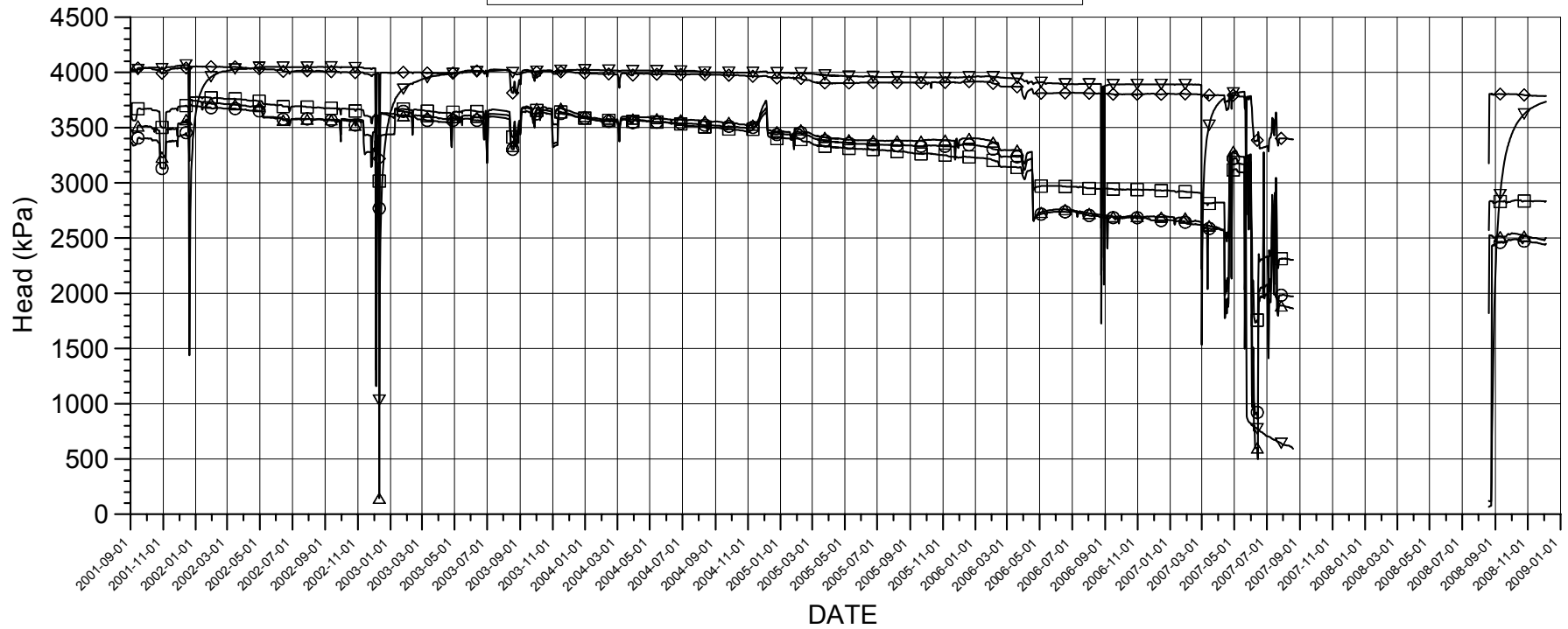

Events

Start backfilling of section I 2001-09-03
 Stop backfilling of section I 2001-11-20
 Casting of inner plug finalized 2001-12-19
 Start backfilling of section II 2003-04-29
 Stop backfilling of section II 2003-06-27
 Casting of outer plug finalized 2003-09-11
 Start drilling of Fine Sealing Project 2007-03-12
 Start grouting of Fine Sealing Project 2007-11-19

Borehole sections

▽ A:1 125 m - 150 m
 ◇ A:2 110 m - 124 m
 □ A:3 75 m - 109 m
 ○ A:4 51 m - 74 m
 △ A:5 4.5 m - 50 m

P_KA3510A.GRF 2008-12-10

KA3539G PRESSURE HEAD

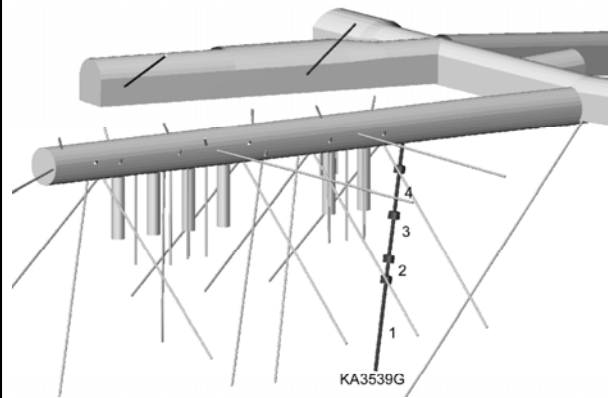
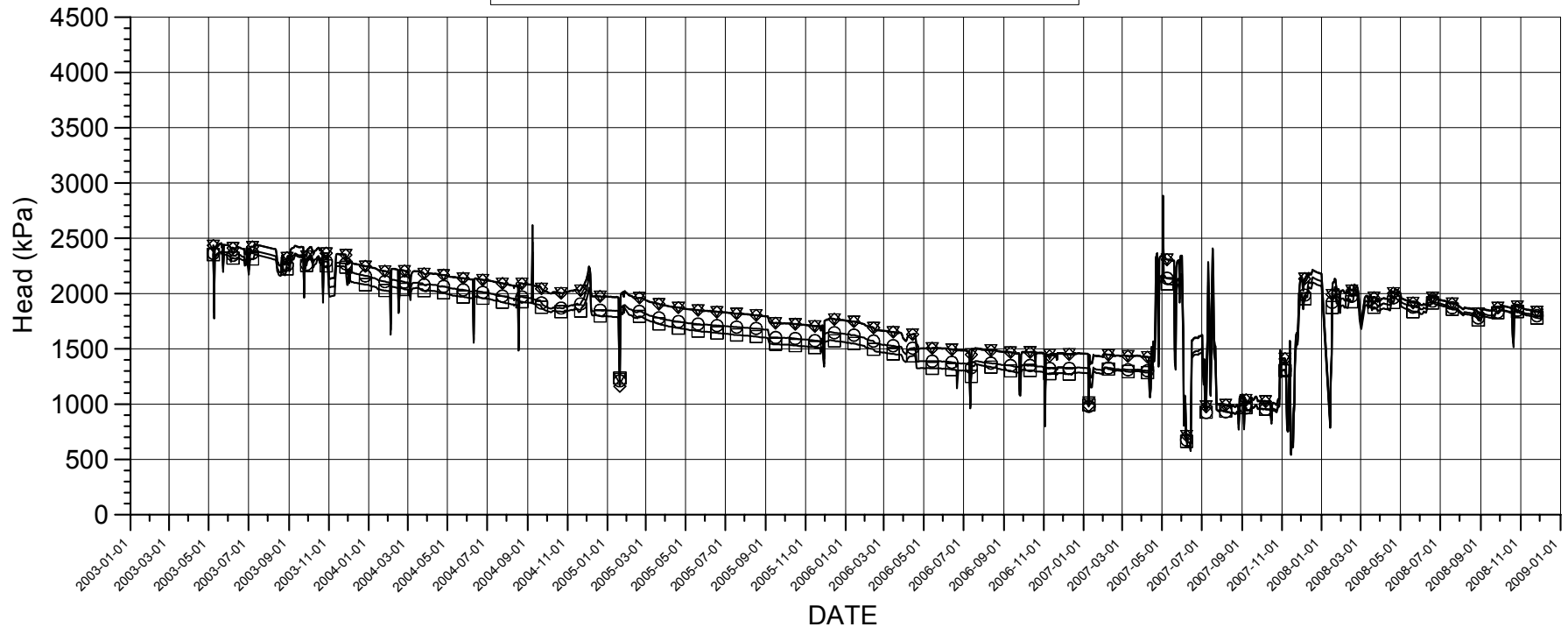

- Events**
- Start backfilling of section I 2001-09-03
 - Stop backfilling of section I 2001-11-20
 - Casting of inner plug finalized 2001-12-19
 - Start backfilling of section II 2003-04-29
 - Stop backfilling of section II 2003-06-27
 - Casting of outer plug finalized 2003-09-11
 - Start drilling of Fine Sealing Project 2007-03-12
 - Start grouting of Fine Sealing Project 2007-11-19

- Borehole sections**
- ▽ — ▽ G:1 18.6 m - 30 m
 - ◇ — ◇ G:2 15.85 m - 17.6 m
 - — □ G:3 10 m - 14.85 m
 - — ○ G:4 4 m - 9 m

KA3542G01 PRESSURE HEAD

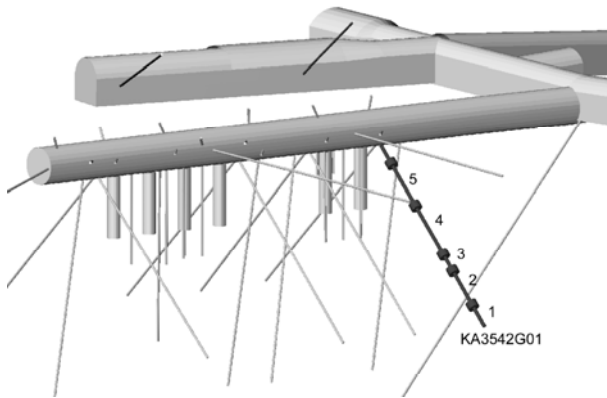
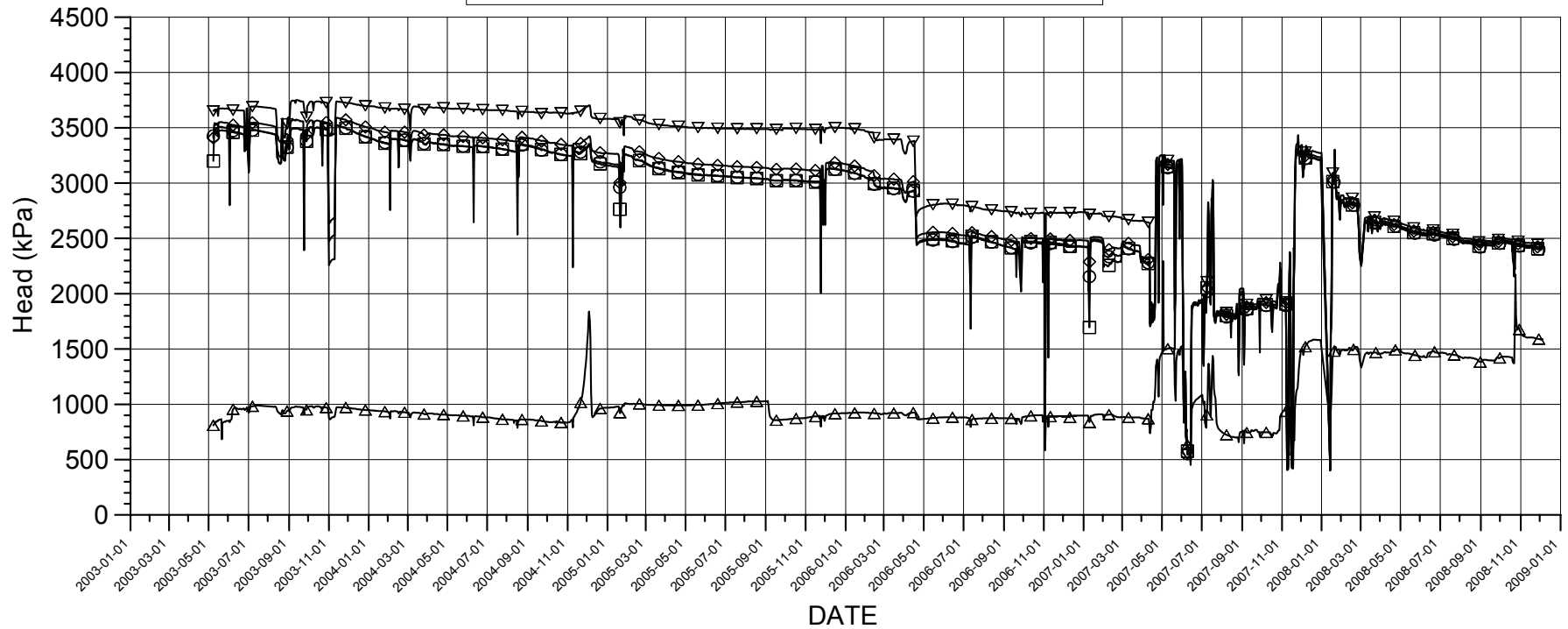

Events

- Start backfilling of section I 2001-09-03
- Stop backfilling of section I 2001-11-20
- Casting of inner plug finalized 2001-12-19
- Start backfilling of section II 2003-04-29
- Stop backfilling of section II 2003-06-27
- Casting of outer plug finalized 2003-09-11
- Start drilling of Fine Sealing Project 2007-03-12
- Start grouting of Fine Sealing Project 2007-11-19

Borehole sections

- ▽ G01:1 27 m - 30 m
- ◇ G01:2 21.3 m - 26 m
- G01:3 18.6 m - 20.3 m
- G01:4 10.5 m - 17.6 m
- △ G01:5 3.5 m - 9.5 m

P_KA3542G01.GRF 2008-12-10

KA3542G02 PRESSURE HEAD

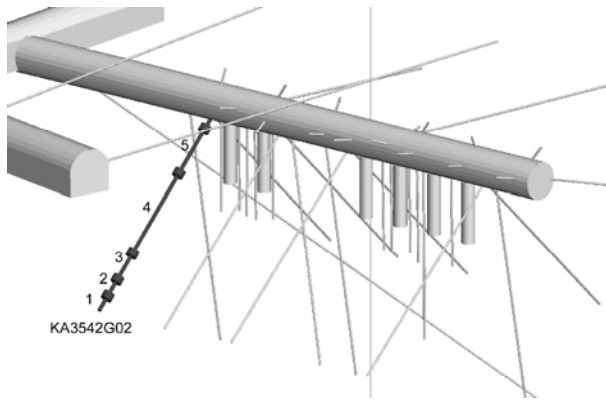
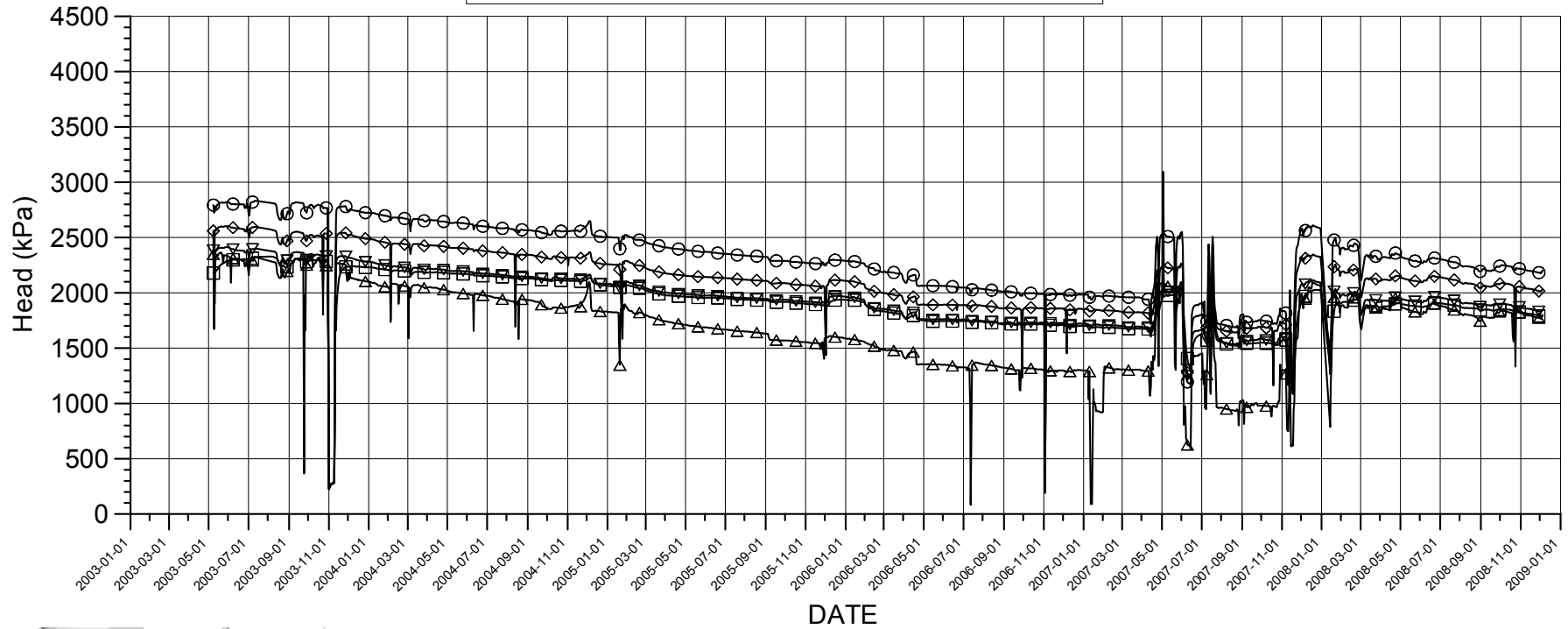

Events

- Start backfilling of section I 2001-09-03
- Stop backfilling of section I 2001-11-20
- Casting of inner plug finalized 2001-12-19
- Start backfilling of section II 2003-04-29
- Stop backfilling of section II 2003-06-27
- Casting of outer plug finalized 2003-09-11
- Start drilling of Fine Sealing Project 2007-03-12
- Start grouting of Fine Sealing Project 2007-11-19

Borehole sections

- ▽ — ▽ G02:1 28.2 m - 30.01 m
- ◇ — ◇ G02:2 25.6 m - 27.2 m
- — □ G02:3 21.5 m - 24.6 m
- — ○ G02:4 9 m - 20.5 m
- △ — △ G02:5 2 m - 8 m

P_KA3542G02.GRF 2008-12-10

KA3543A01, KA3543I01, KA3548D01 PRESSURE HEAD

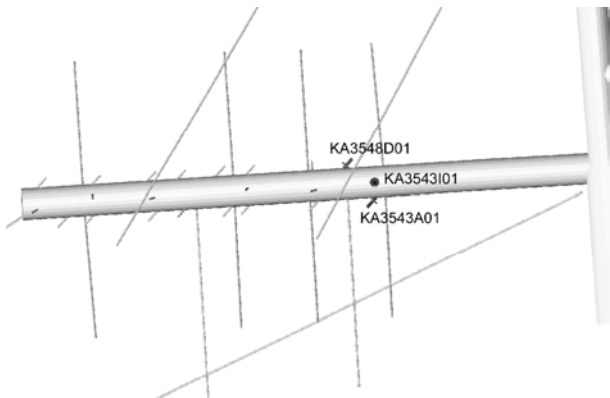
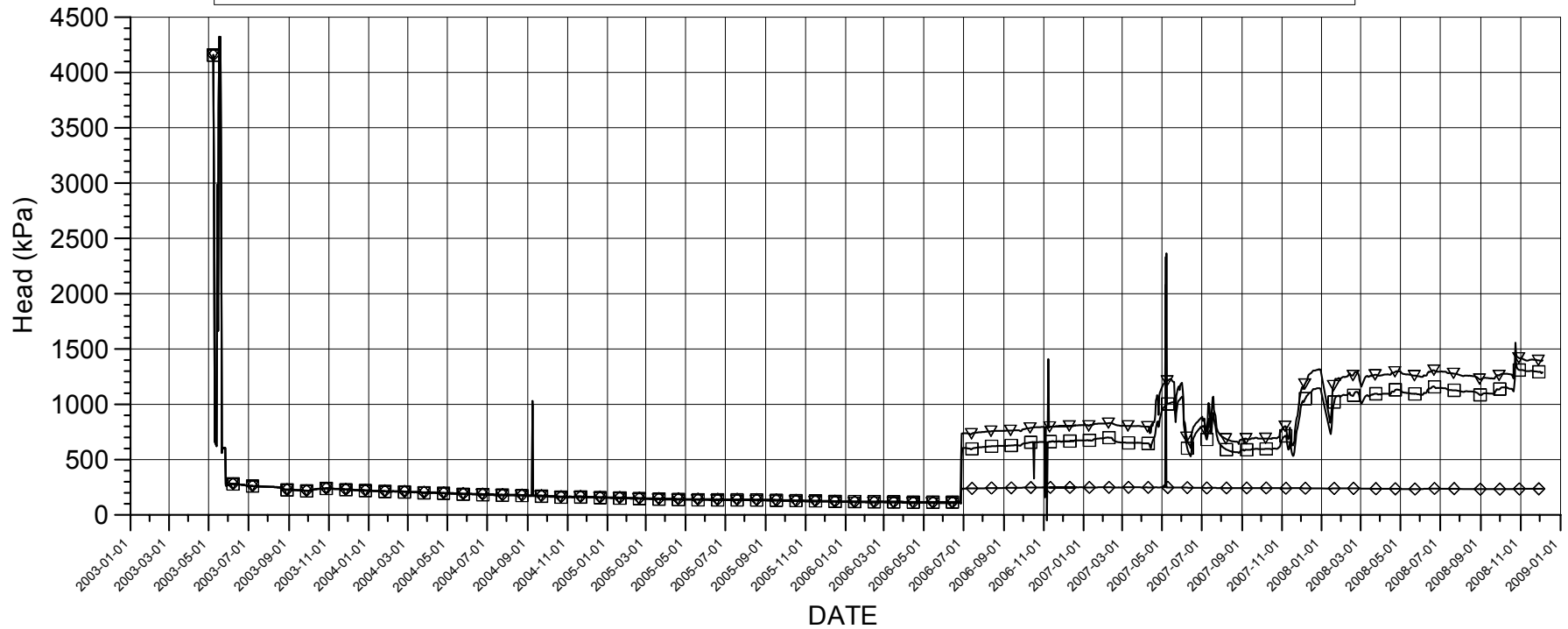

Events

- Start backfilling of section I 2001-09-03
- Stop backfilling of section I 2001-11-20
- Casting of inner plug finalized 2001-12-19
- Start backfilling of section II 2003-04-29
- Stop backfilling of section II 2003-06-27
- Casting of outer plug finalized 2003-09-11
- Start drilling of Fine Sealing Project 2007-03-12
- Start grouting of Fine Sealing Project 2007-11-19

Borehole sections

- ▽ KA3543A01:1 0.65 m - 2 m
- ◇ KA3543I01:1 0.65 m - 2 m
- KA3548D01:1 0.65 m - 2 m

KA3544G01 PRESSURE HEAD

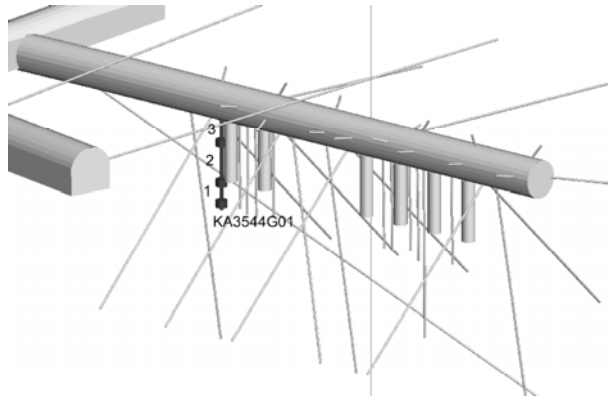
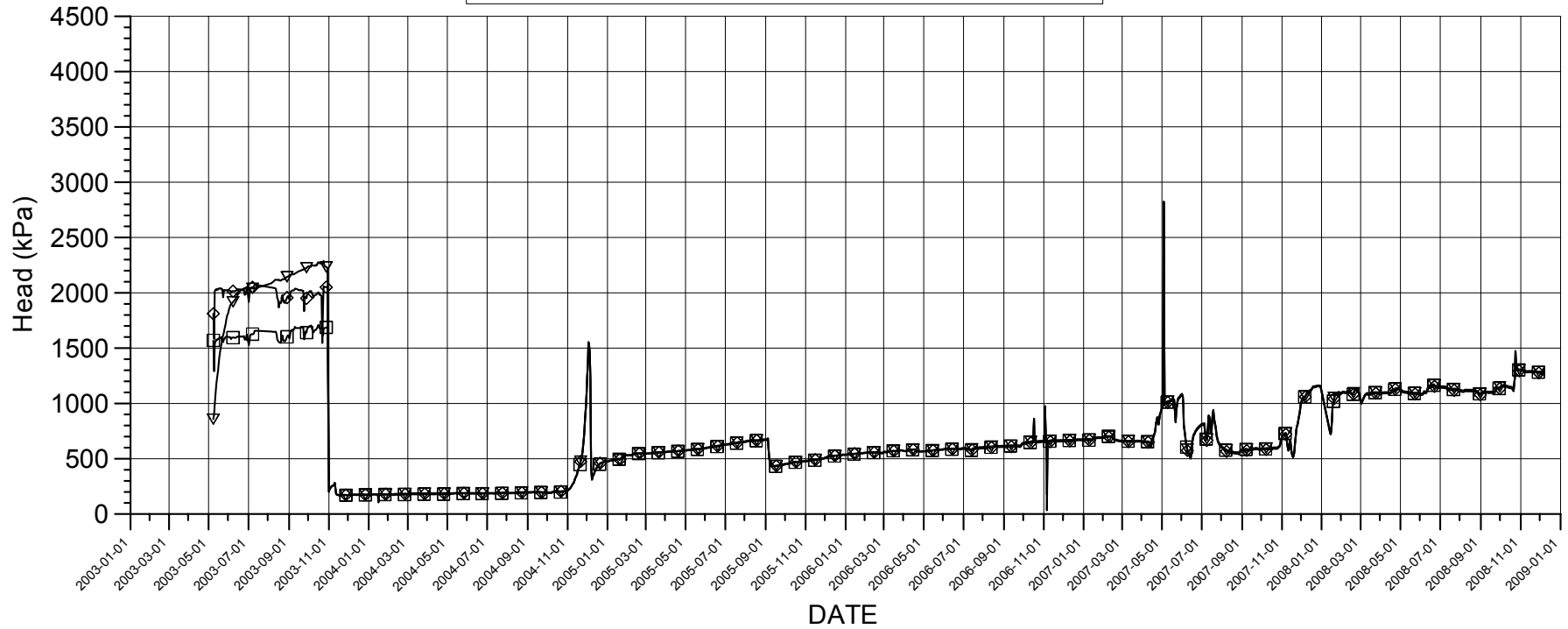

Events

- Start backfilling of section I 2001-09-03
- Stop backfilling of section I 2001-11-20
- Casting of inner plug finalized 2001-12-19
- Start backfilling of section II 2003-04-29
- Stop backfilling of section II 2003-06-27
- Casting of outer plug finalized 2003-09-11
- Start drilling of Fine Sealing Project 2007-03-12
- Start grouting of Fine Sealing Project 2007-11-19

Borehole sections

- ▽ G01:1 11.65 m - 12 m
- ◇ G01:2 8.9 m - 10.65 m
- G01:3 3.5 m - 7.9 m

KA3546G01 PRESSURE HEAD

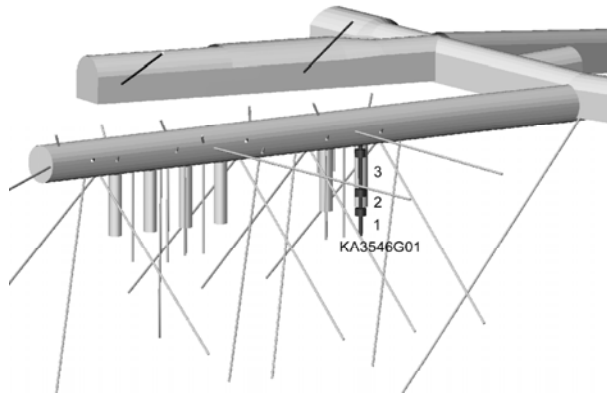
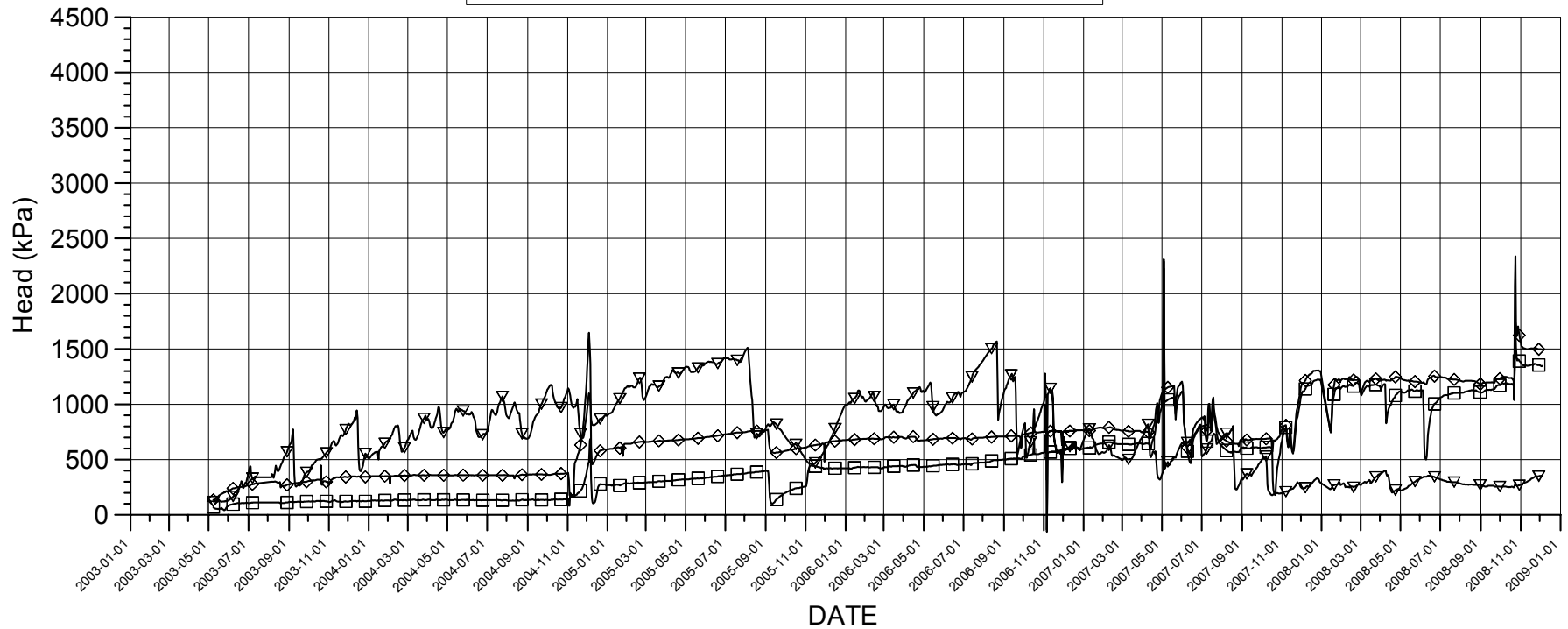

Events

- Start backfilling of section I 2001-09-03
- Stop backfilling of section I 2001-11-20
- Casting of inner plug finalized 2001-12-19
- Start backfilling of section II 2003-04-29
- Stop backfilling of section II 2003-06-27
- Casting of outer plug finalized 2003-09-11
- Start drilling of Fine Sealing Project 2007-03-12
- Start grouting of Fine Sealing Project 2007-11-19

Borehole sections

- ▽ — ▽ G01:1 9.3 m - 12 m
- ◇ — ◇ G01:2 6.75 m - 8.3 m
- — □ G01:3 1.5 m - 5.75 m

KA3548A01 PRESSURE HEAD

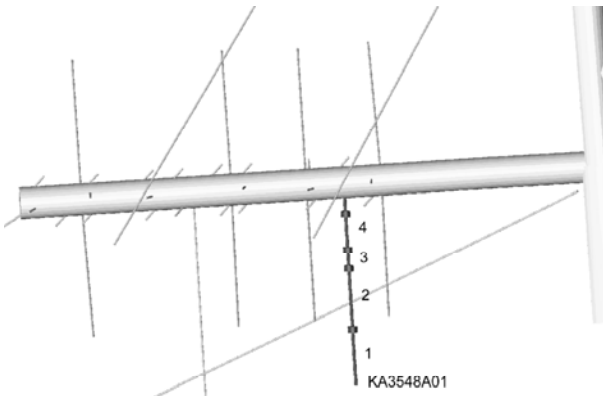
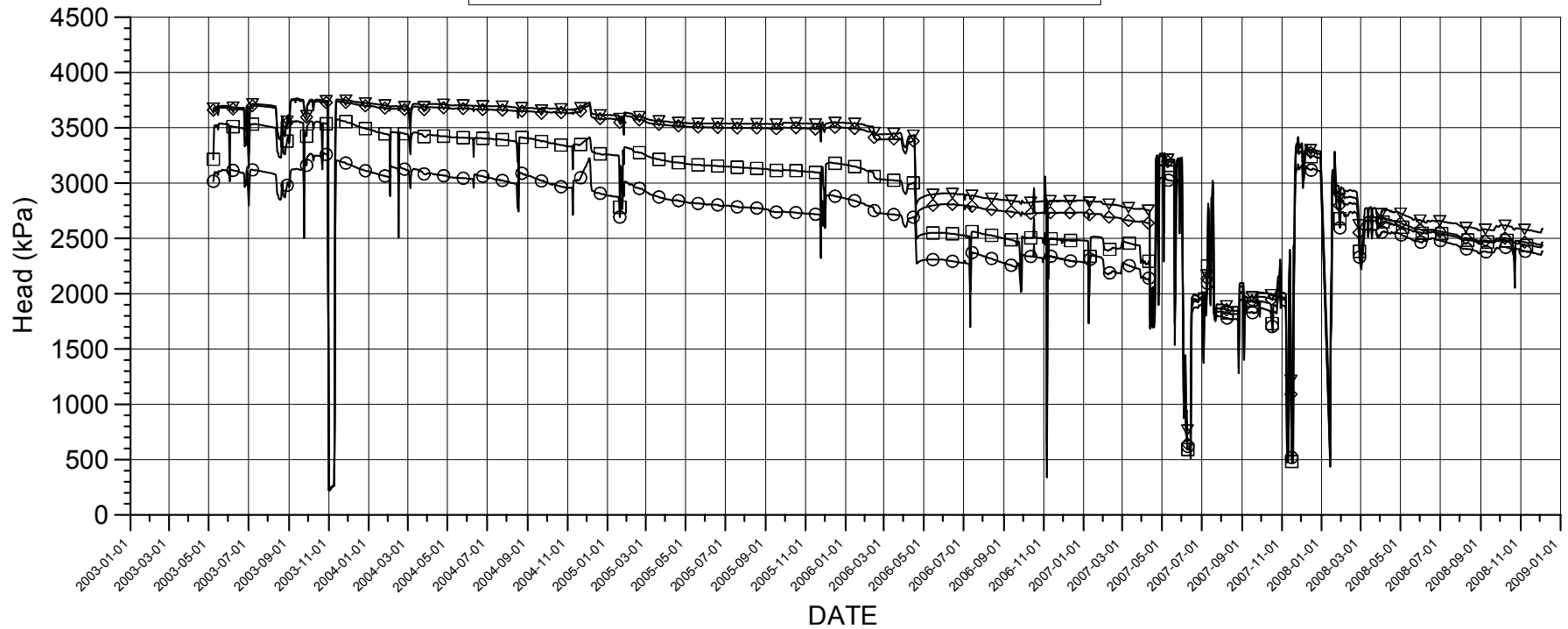

Events

- Start backfilling of section I 2001-09-03
- Stop backfilling of section I 2001-11-20
- Casting of inner plug finalized 2001-12-19
- Start backfilling of section II 2003-04-29
- Stop backfilling of section II 2003-06-27
- Casting of outer plug finalized 2003-09-11
- Start drilling of Fine Sealing Project 2007-03-12
- Start grouting of Fine Sealing Project 2007-11-19

Borehole sections

- ▽ — ▽ A01:1 21.5 m - 30 m
- ◇ — ◇ A01:2 11.75 m - 20.5 m
- — □ A01:3 8.8 m - 10.75 m
- — ○ A01:4 3 m - 7.8 m

KA3548G01 PRESSURE HEAD

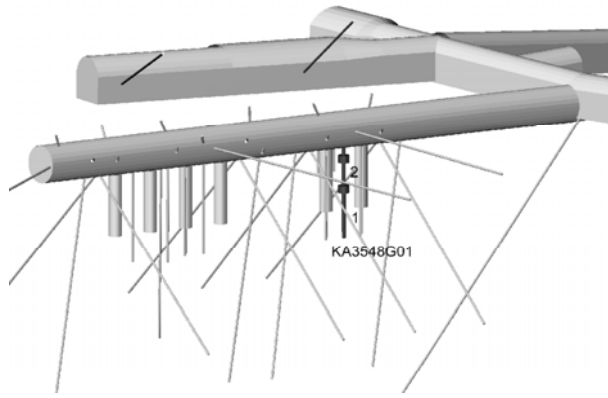
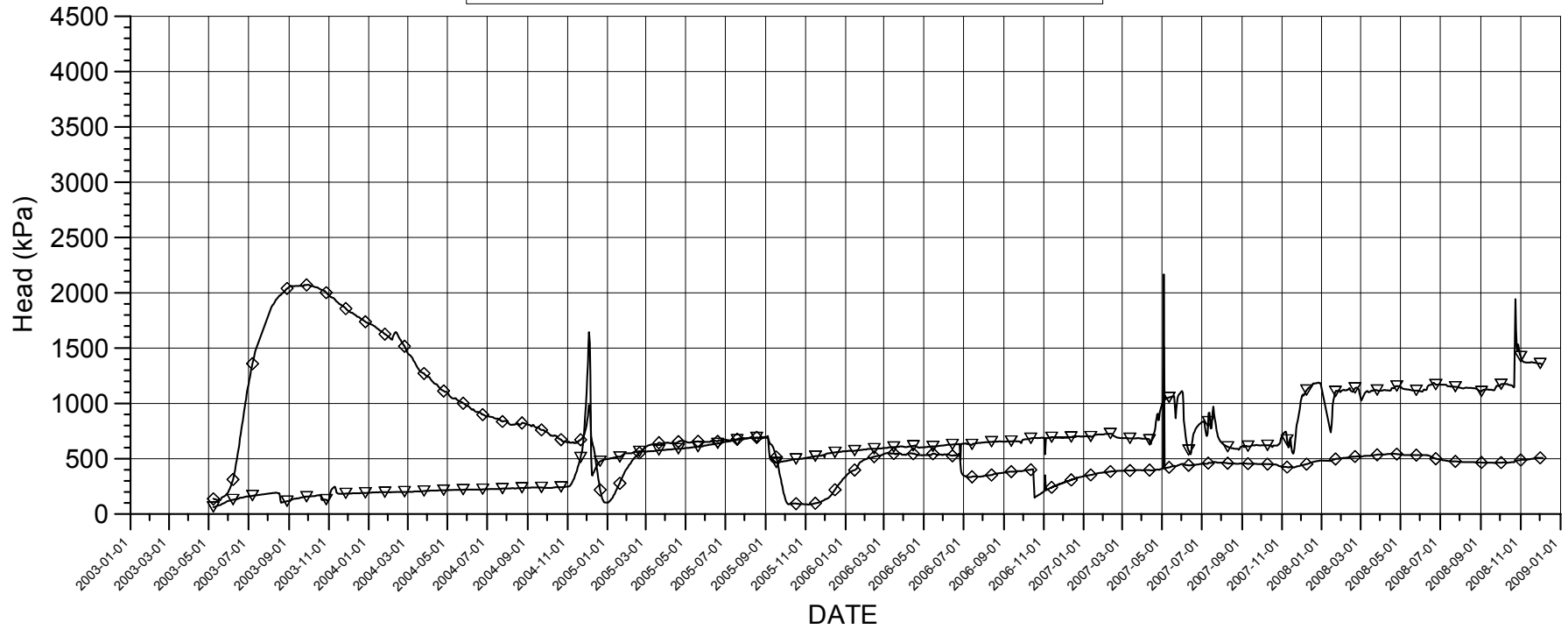

- Events**
- Start backfilling of section I 2001-09-03
 - Stop backfilling of section I 2001-11-20
 - Casting of inner plug finalized 2001-12-19
 - Start backfilling of section II 2003-04-29
 - Stop backfilling of section II 2003-06-27
 - Casting of outer plug finalized 2003-09-11
 - Start drilling of Fine Sealing Project 2007-03-12
 - Start grouting of Fine Sealing Project 2007-11-19

- Borehole sections**
- ▽ — ▽ G01:1 6 m - 12 m
 - ◇ — ◇ G01:2 2 m - 5 m

KA3550G01 PRESSURE HEAD

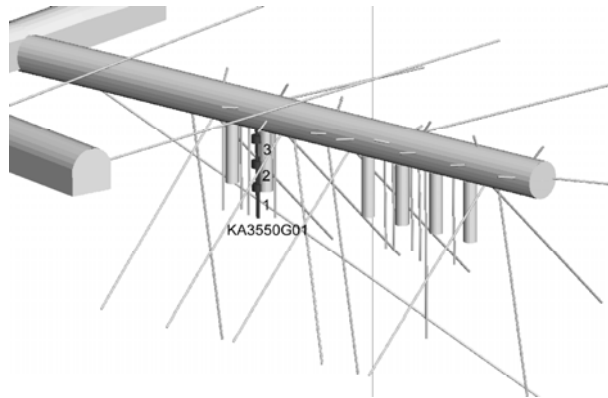
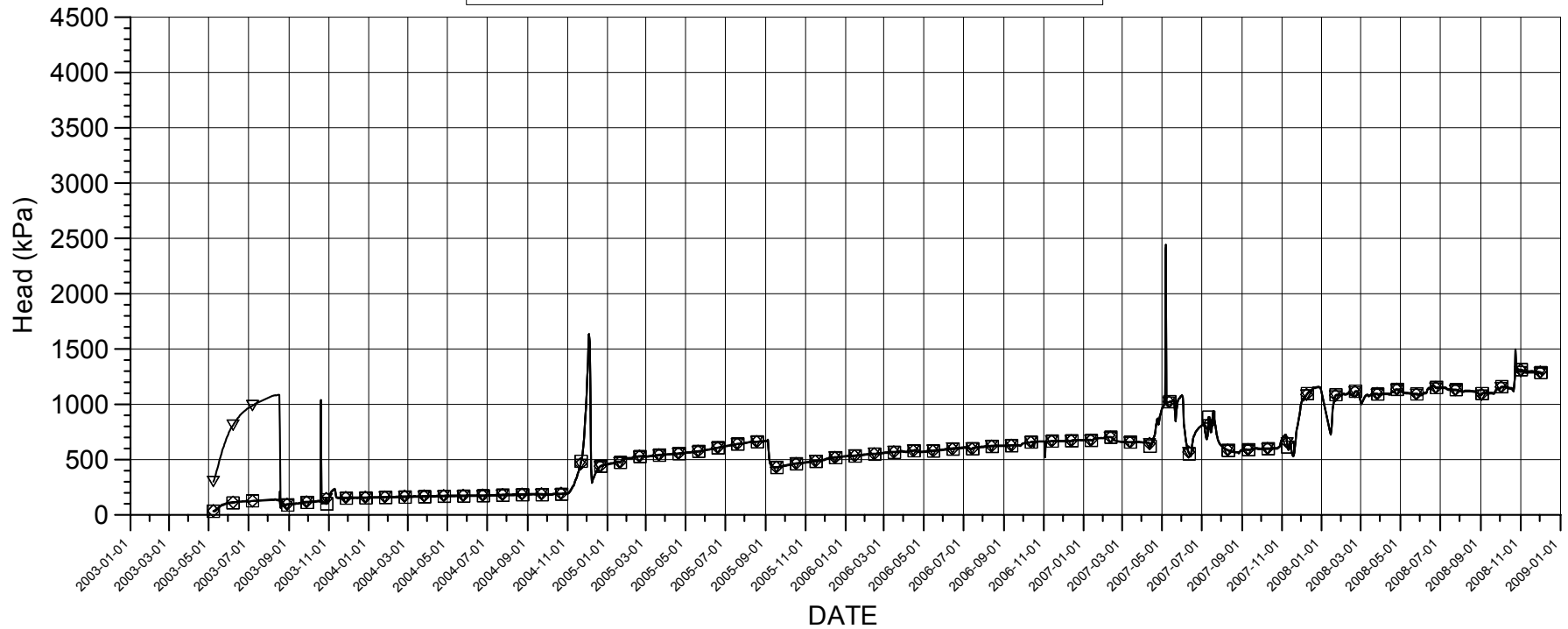

Events

- Start backfilling of section I 2001-09-03
- Stop backfilling of section I 2001-11-20
- Casting of inner plug finalized 2001-12-19
- Start backfilling of section II 2003-04-29
- Stop backfilling of section II 2003-06-27
- Casting of outer plug finalized 2003-09-11
- Start drilling of Fine Sealing Project 2007-03-12
- Start grouting of Fine Sealing Project 2007-11-19

Borehole sections

- ▽ — ▽ G01:1 8.3 m - 12.03 m
- ◇ — ◇ G01:2 5.2 m - 7.3 m
- — □ G01:3 1.8 m - 4.2 m

KA3550G05, KA3551G05 PRESSURE HEAD

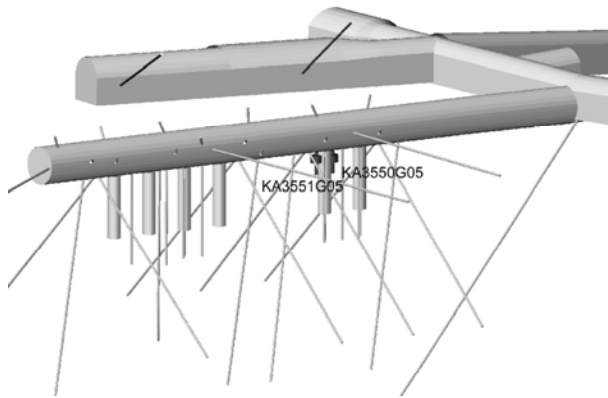
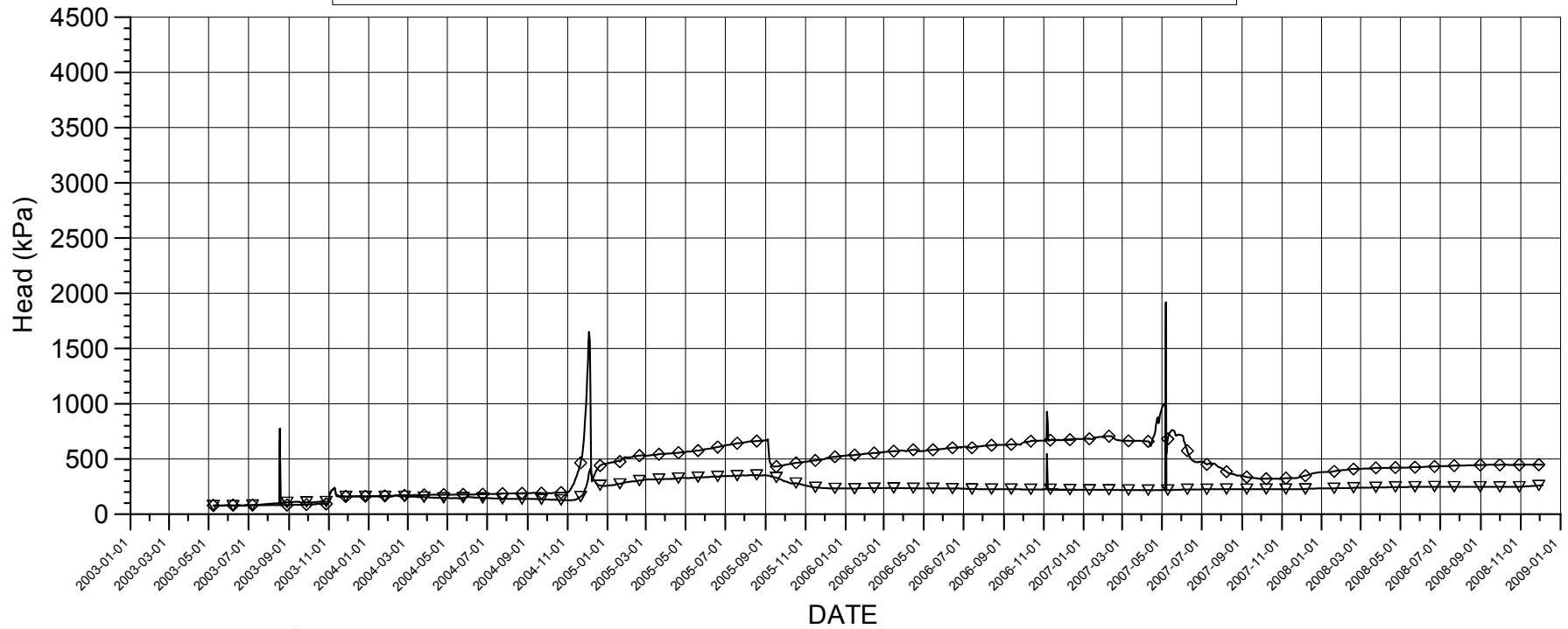

- Events**
- Start backfilling of section I 2001-09-03
 - Stop backfilling of section I 2001-11-20
 - Casting of inner plug finalized 2001-12-19
 - Start backfilling of section II 2003-04-29
 - Stop backfilling of section II 2003-06-27
 - Casting of outer plug finalized 2003-09-11
 - Start drilling of Fine Sealing Project 2007-03-12
 - Start grouting of Fine Sealing Project 2007-11-19

- Borehole sections**
- ▽ KA3550G05:1 1.5 m - 3 m
 - ◇ KA3551G05:1 1.5 m - 3.1 m

KA3552A01, KA3552H01, KA3553B01 PRESSURE HEAD

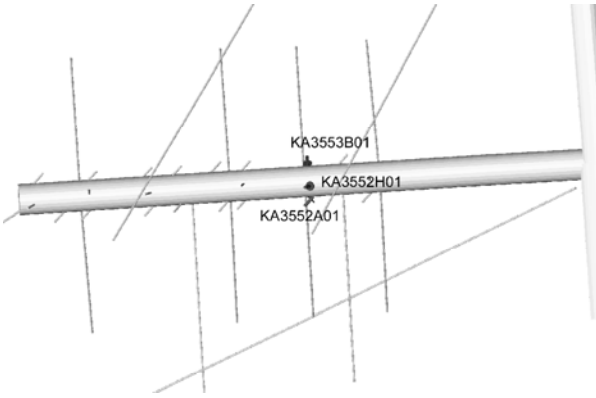
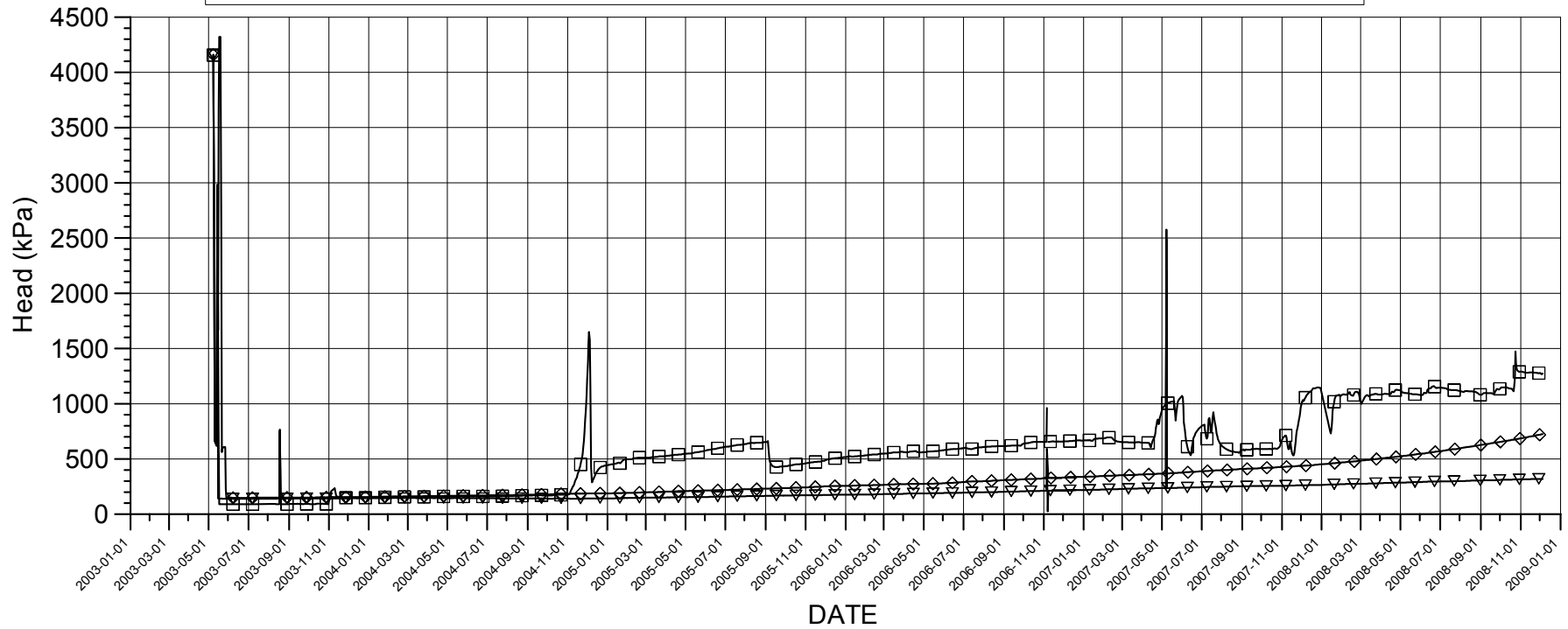

- Events**
- Start backfilling of section I 2001-09-03
 - Stop backfilling of section I 2001-11-20
 - Casting of inner plug finalized 2001-12-19
 - Start backfilling of section II 2003-04-29
 - Stop backfilling of section II 2003-06-27
 - Casting of outer plug finalized 2003-09-11
 - Start drilling of Fine Sealing Project 2007-03-12
 - Start grouting of Fine Sealing Project 2007-11-19

- Borehole sections**
- ▽ — ▽ KA3552A01:1 0.65 m - 2 m
 - ◇ — ◇ KA3552H01:1 0.65 m - 2 m
 - — □ KA3553B01:1 0.65 m - 2 m

KA3552G01 PRESSURE HEAD

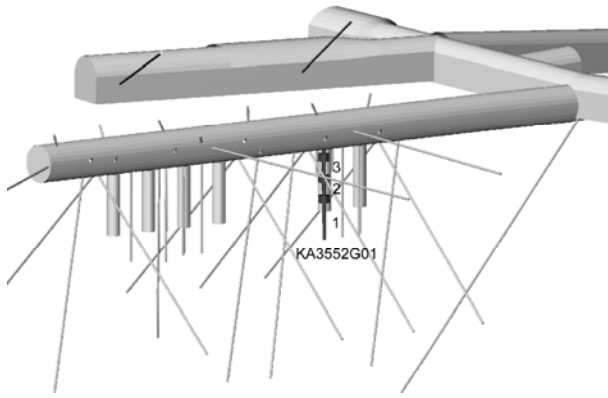
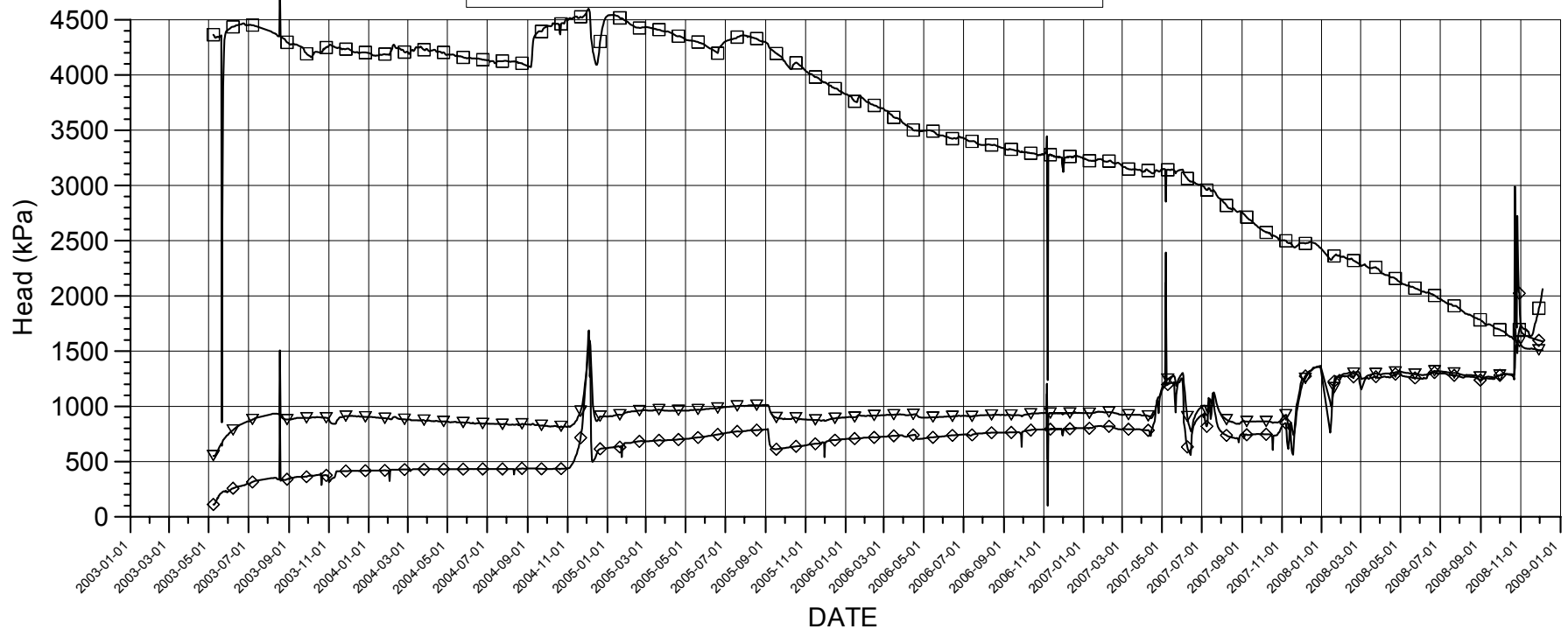

- Events**
- Start backfilling of section I 2001-09-03
 - Stop backfilling of section I 2001-11-20
 - Casting of inner plug finalized 2001-12-19
 - Start backfilling of section II 2003-04-29
 - Stop backfilling of section II 2003-06-27
 - Casting of outer plug finalized 2003-09-11
 - Start drilling of Fine Sealing Project 2007-03-12
 - Start grouting of Fine Sealing Project 2007-11-19

- Borehole sections**
- ▽ — ▽ G01:1 7.05 m - 12 m
 - ◇ — ◇ G01:2 4.35 m - 6.05 m
 - — □ G01:3 1.5 m - 3.35 m

KA3554G01 PRESSURE HEAD

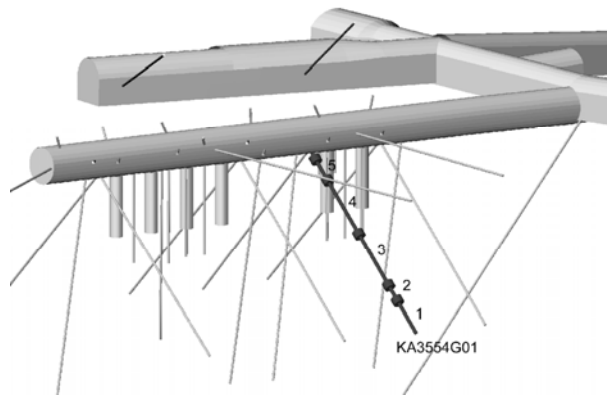
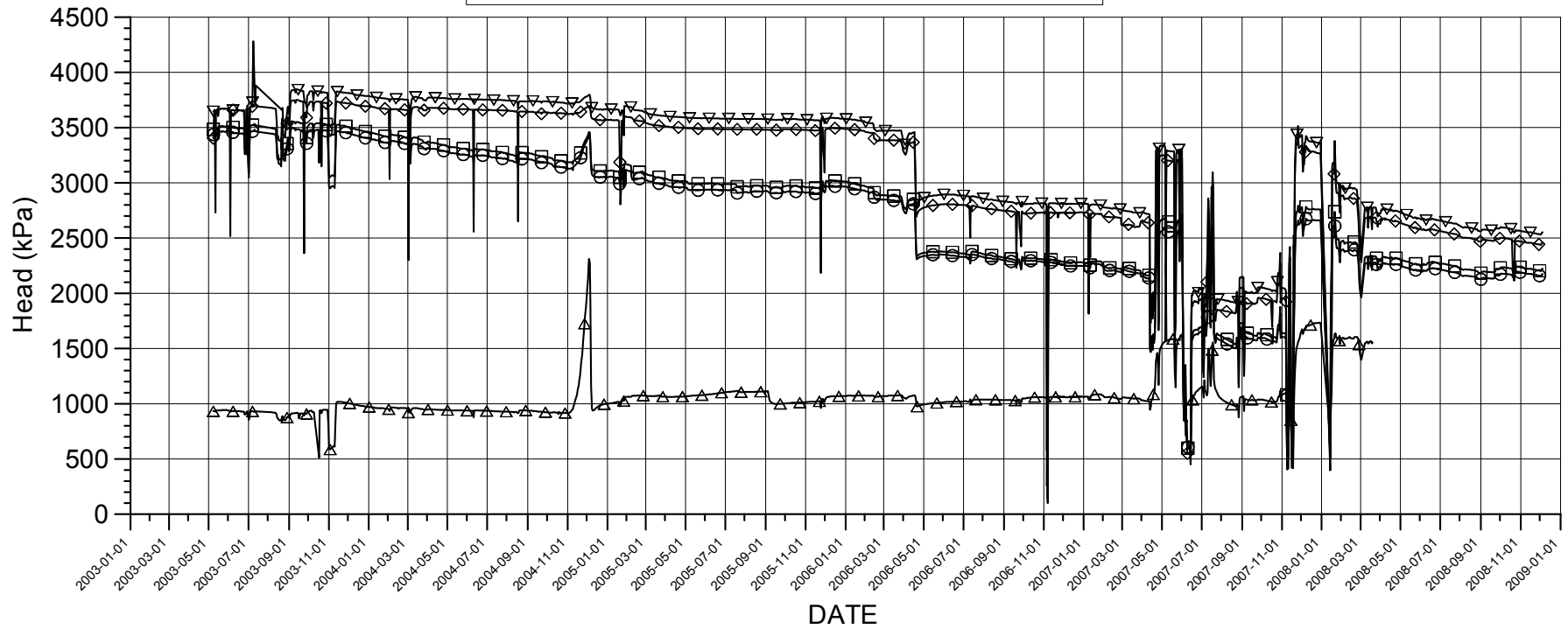

Events

- Start backfilling of section I 2001-09-03
- Stop backfilling of section I 2001-11-20
- Casting of inner plug finalized 2001-12-19
- Start backfilling of section II 2003-04-29
- Stop backfilling of section II 2003-06-27
- Casting of outer plug finalized 2003-09-11
- Start drilling of Fine Sealing Project 2007-03-12
- Start grouting of Fine Sealing Project 2007-11-19

Borehole sections

- ▽ — ▽ G01:1 25.15 m - 30.01 m
- ◇ — ◇ G01:2 22.6 m - 24.15 m
- — □ G01:3 14 m - 21.6 m
- — ○ G01:4 5 m - 13 m
- △ — △ G01:5 1.5 m - 4 m

P_KA3554G01.GRF 2008-12-10

KA3554G02 PRESSURE HEAD

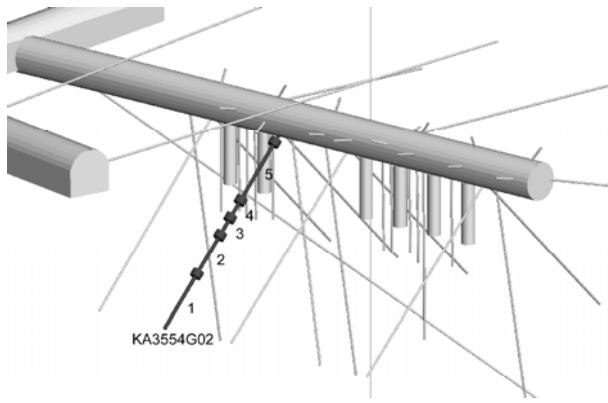
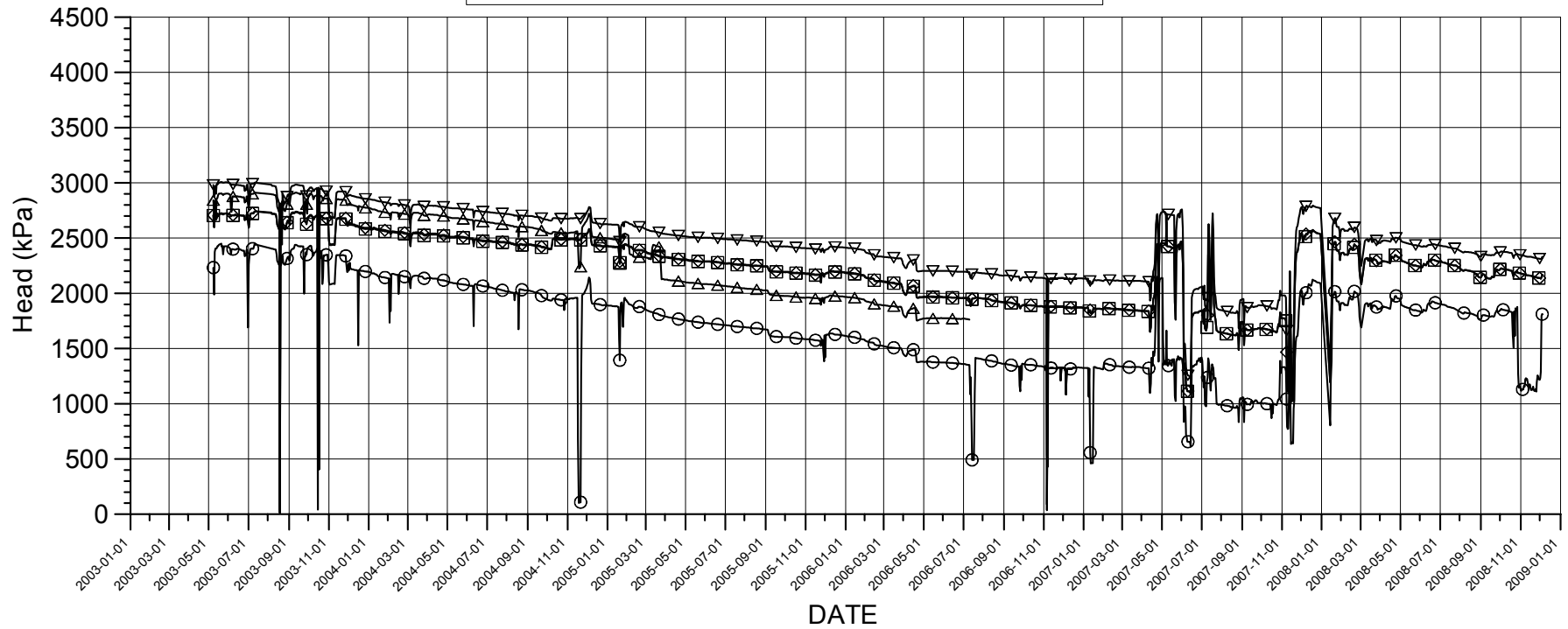

Events

- Start backfilling of section I 2001-09-03
- Stop backfilling of section I 2001-11-20
- Casting of inner plug finalized 2001-12-19
- Start backfilling of section II 2003-04-29
- Stop backfilling of section II 2003-06-27
- Casting of outer plug finalized 2003-09-11
- Start drilling of Fine Sealing Project 2007-03-12
- Start grouting of Fine Sealing Project 2007-11-19

Borehole sections

- ▽ — ▽ G02:1 22 m - 30.01 m
- ◇ — ◇ G02:2 15.9 m - 21 m
- — □ G02:3 13.2 m - 14.9 m
- — ○ G02:4 10.5 m - 12.2 m
- △ — △ G02:5 1.5 m - 9.5 m

P_KA3554G02.GRF 2008-12-10

KA3557G PRESSURE HEAD

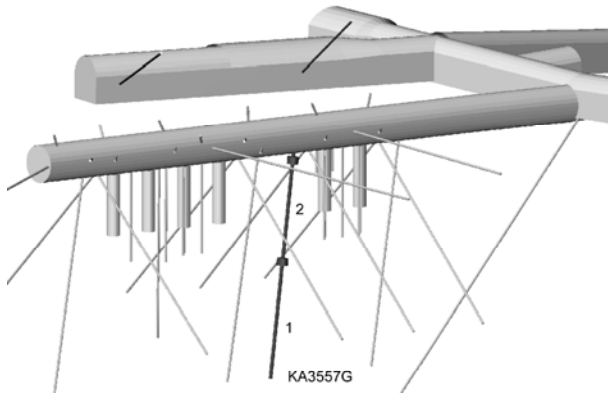
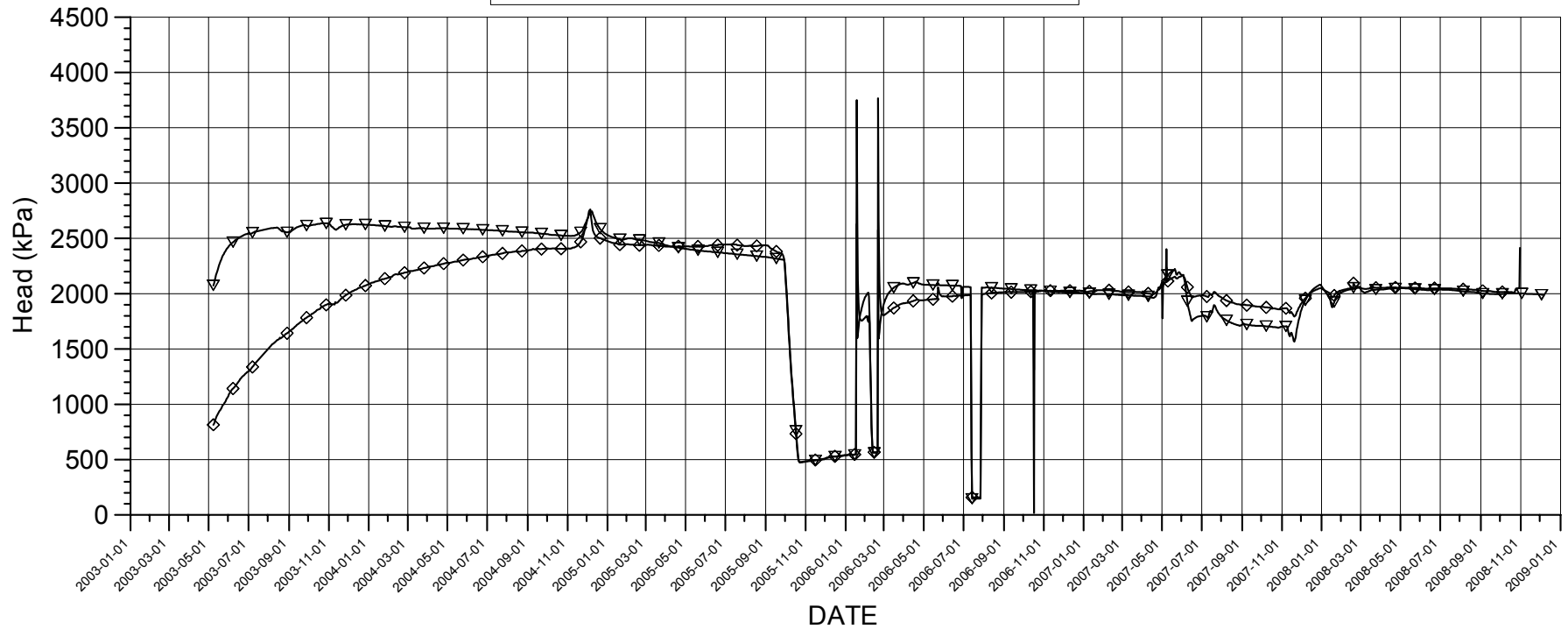

Events

- Start backfilling of section I 2001-09-03
- Stop backfilling of section I 2001-11-20
- Casting of inner plug finalized 2001-12-19
- Start backfilling of section II 2003-04-29
- Stop backfilling of section II 2003-06-27
- Casting of outer plug finalized 2003-09-11
- Start drilling of Fine Sealing Project 2007-03-12
- Start grouting of Fine Sealing Project 2007-11-19

Borehole sections

- ▽ — ▽ G:1 15 m - 30.04 m
- ◇ — ◇ G:2 1.5 m - 14 m

KA3563A01, KA3563D01, KA3563I01 PRESSURE HEAD

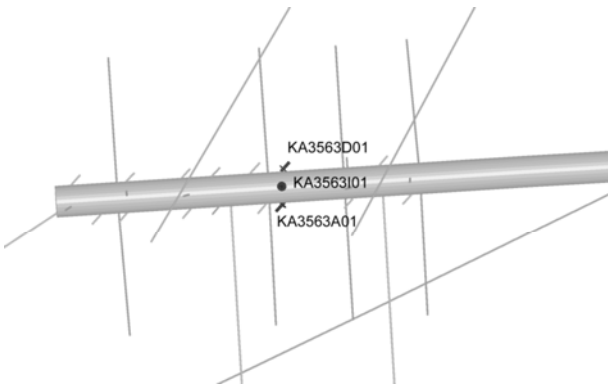
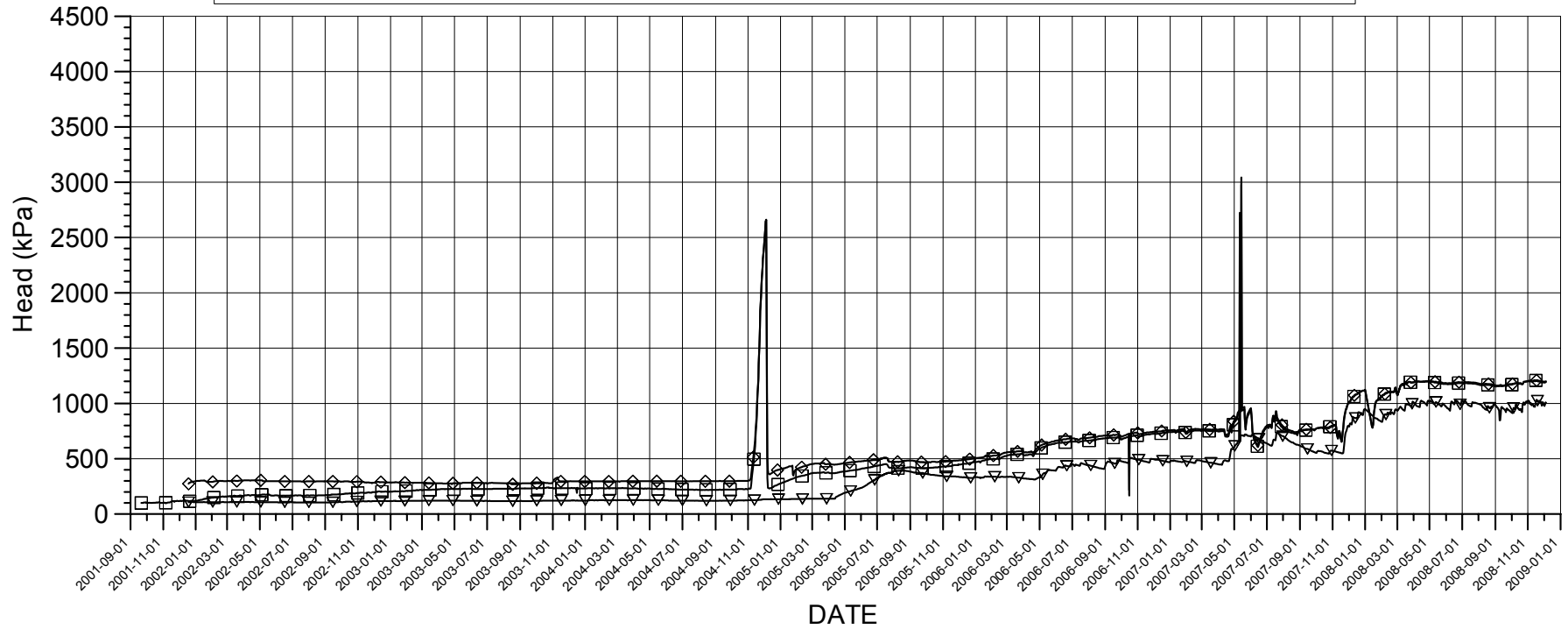

Events

- Start backfilling of section I 2001-09-03
- Stop backfilling of section I 2001-11-20
- Casting of inner plug finalized 2001-12-19
- Start backfilling of section II 2003-04-29
- Stop backfilling of section II 2003-06-27
- Casting of outer plug finalized 2003-09-11
- Start drilling of Fine Sealing Project 2007-03-12
- Start grouting of Fine Sealing Project 2007-11-19

Borehole sections

- ▽ KA3563A01:1 0.65 m - 2 m
- ◇ KA3563D01:1 0.65 m - 2 m
- KA3563I01:1 0.65 m - 2 m

KA3563G PRESSURE HEAD

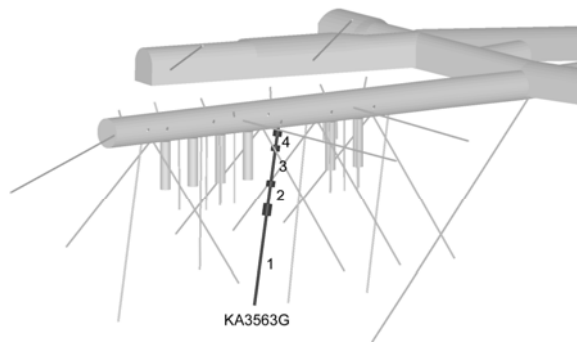
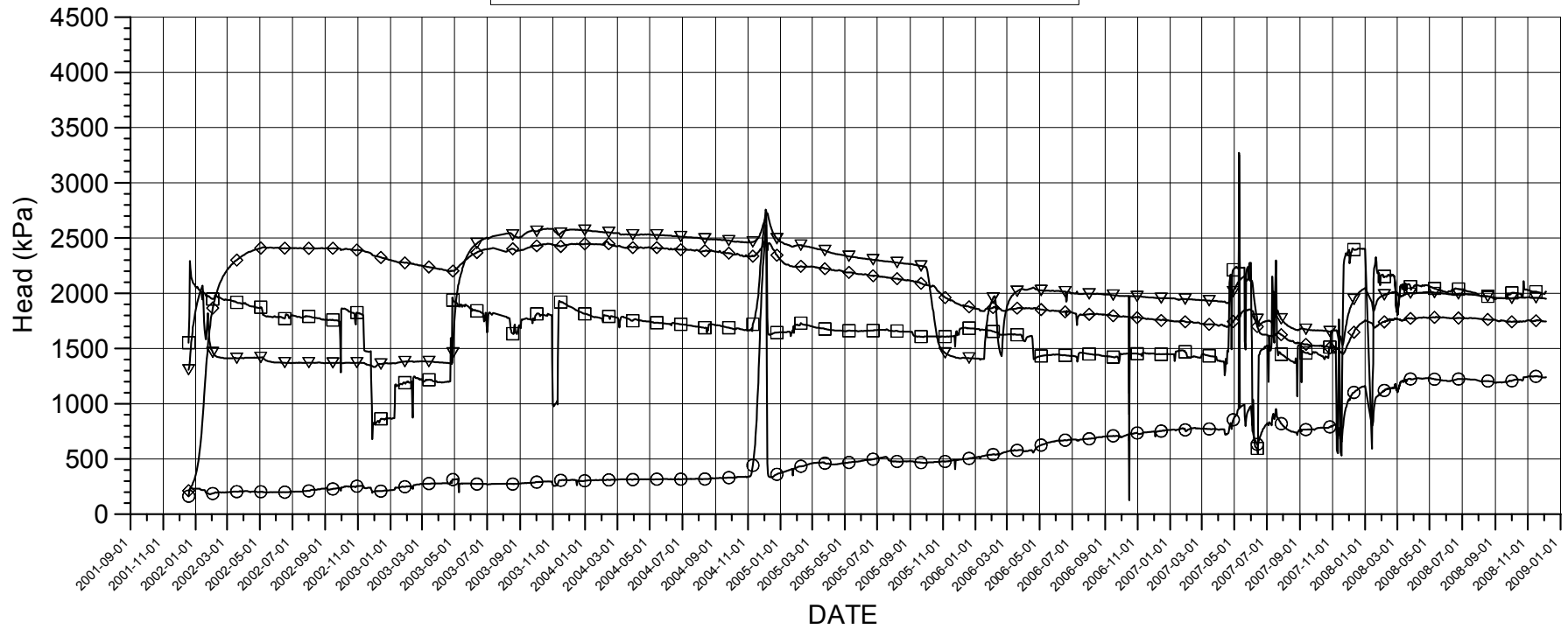

Events

- Start backfilling of section I 2001-09-03
- Stop backfilling of section I 2001-11-20
- Casting of inner plug finalized 2001-12-19
- Start backfilling of section II 2003-04-29
- Stop backfilling of section II 2003-06-27
- Casting of outer plug finalized 2003-09-11
- Start drilling of Fine Sealing Project 2007-03-12
- Start grouting of Fine Sealing Project 2007-11-19

Borehole sections

- ▽ G:1 15 m - 30 m
- ◇ G:2 10 m - 13 m
- G:3 4 m - 8 m
- G:4 1.5 m - 3 m

KA3566C01, KA3568D01, KA3573C01, KA3574D01 PRESSURE HEAD

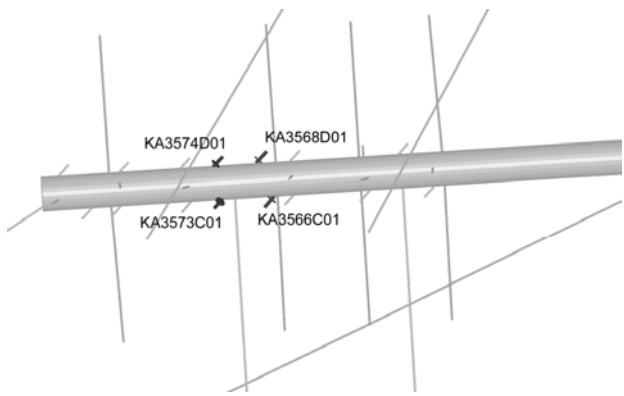
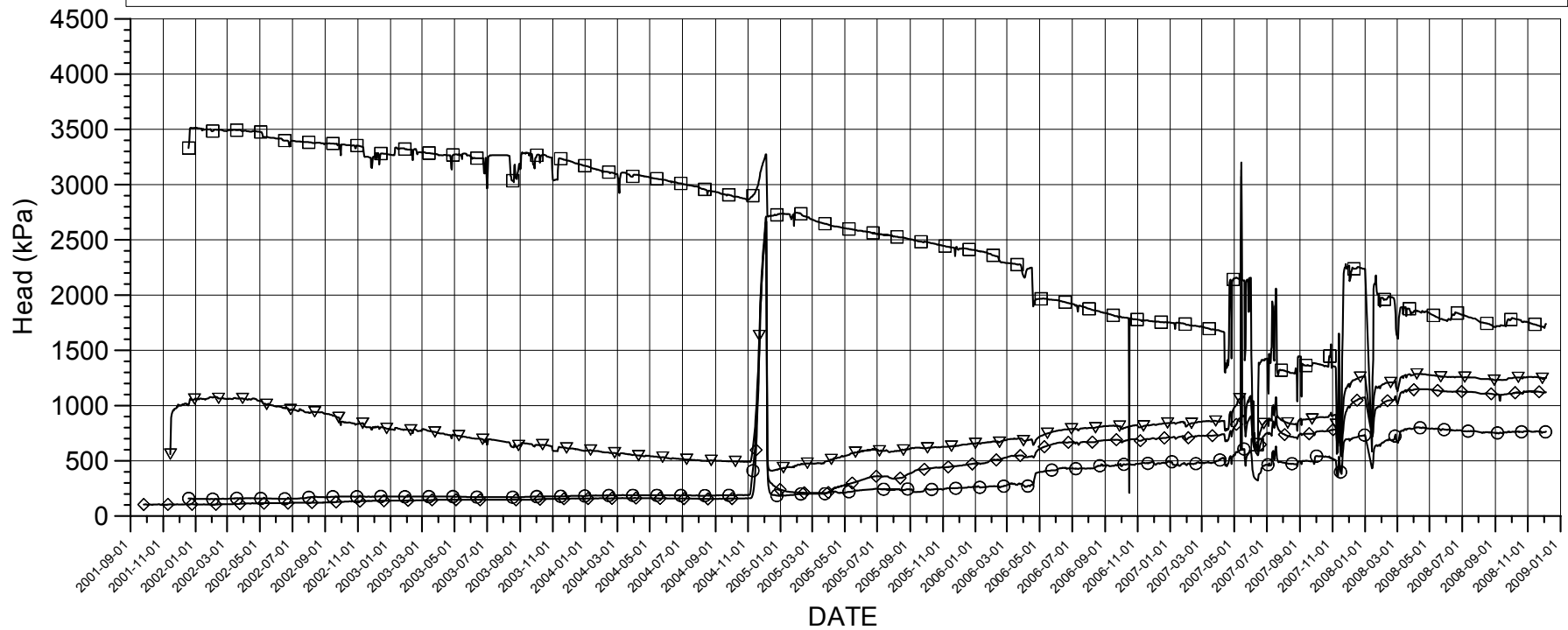

Events

- Start backfilling of section I 2001-09-03
- Stop backfilling of section I 2001-11-20
- Casting of inner plug finalized 2001-12-19
- Start backfilling of section II 2003-04-29
- Stop backfilling of section II 2003-06-27
- Casting of outer plug finalized 2003-09-11
- Start drilling of Fine Sealing Project 2007-03-12
- Start grouting of Fine Sealing Project 2007-11-19

Borehole sections

- ▽—▽ KA3566C01:1 0.65 m - 2 m
- ◇—◇ KA3568D01:1 0.65 m - 2 m
- KA3573C01:1 0.65 m - 2 m
- KA3574D01:1 0.65 m - 2 m

KA3566G01 PRESSURE HEAD

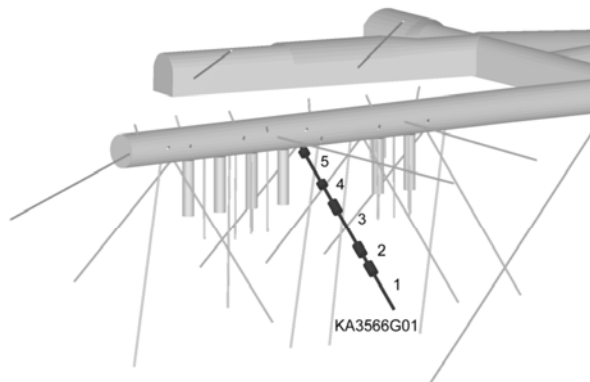
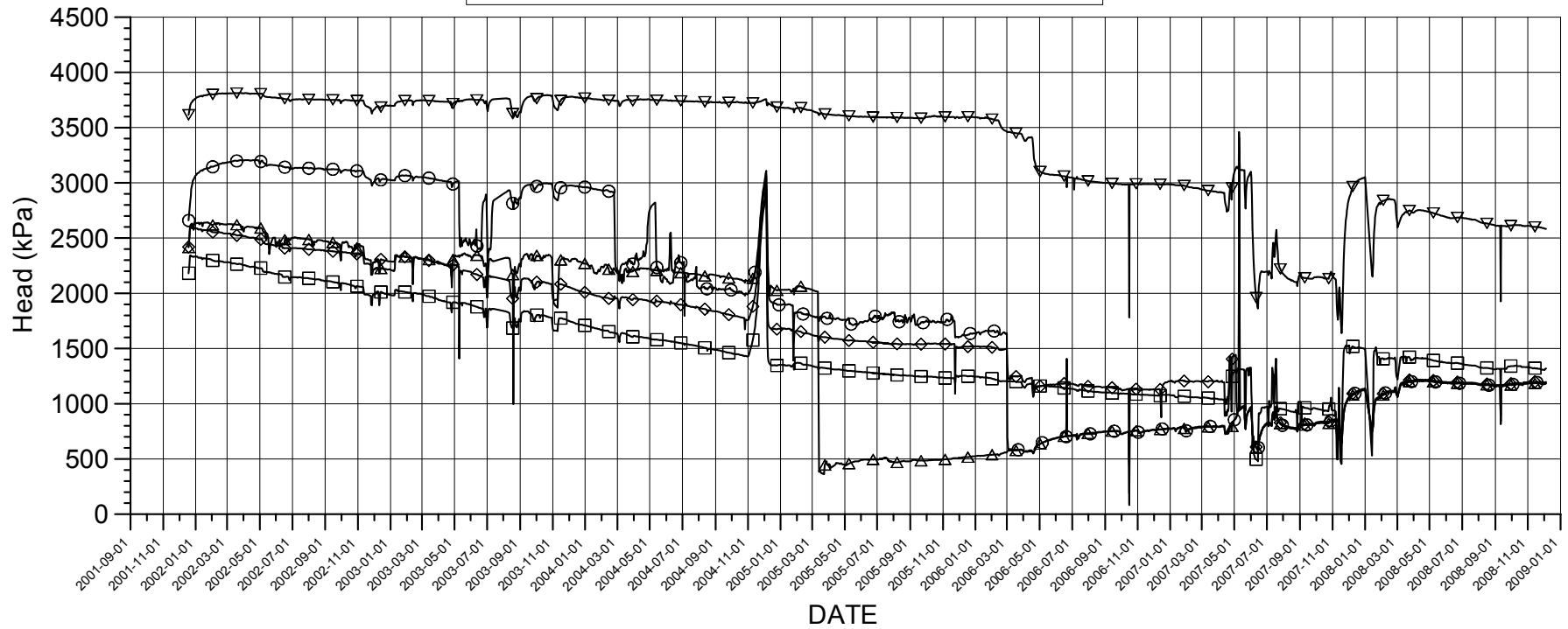

Events

- Start backfilling of section I 2001-09-03
- Stop backfilling of section I 2001-11-20
- Casting of inner plug finalized 2001-12-19
- Start backfilling of section II 2003-04-29
- Stop backfilling of section II 2003-06-27
- Casting of outer plug finalized 2003-09-11
- Start drilling of Fine Sealing Project 2007-03-12
- Start grouting of Fine Sealing Project 2007-11-19

Borehole sections

- ▽ — ▽ G01:1 23.5 m - 30 m
- ◇ — ◇ G01:2 20 m - 21.5 m
- — □ G01:3 12 m - 18 m
- — ○ G01:4 7.3 m - 10 m
- △ — △ G01:5 1.5 m - 6.3 m

P_KA3566G01.GRF 2008-12-10

KA3566G02 PRESSURE HEAD

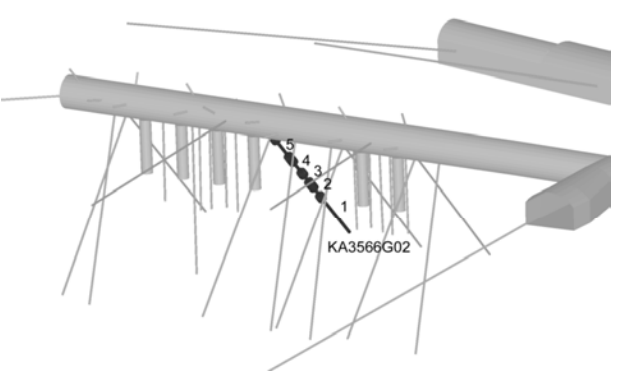
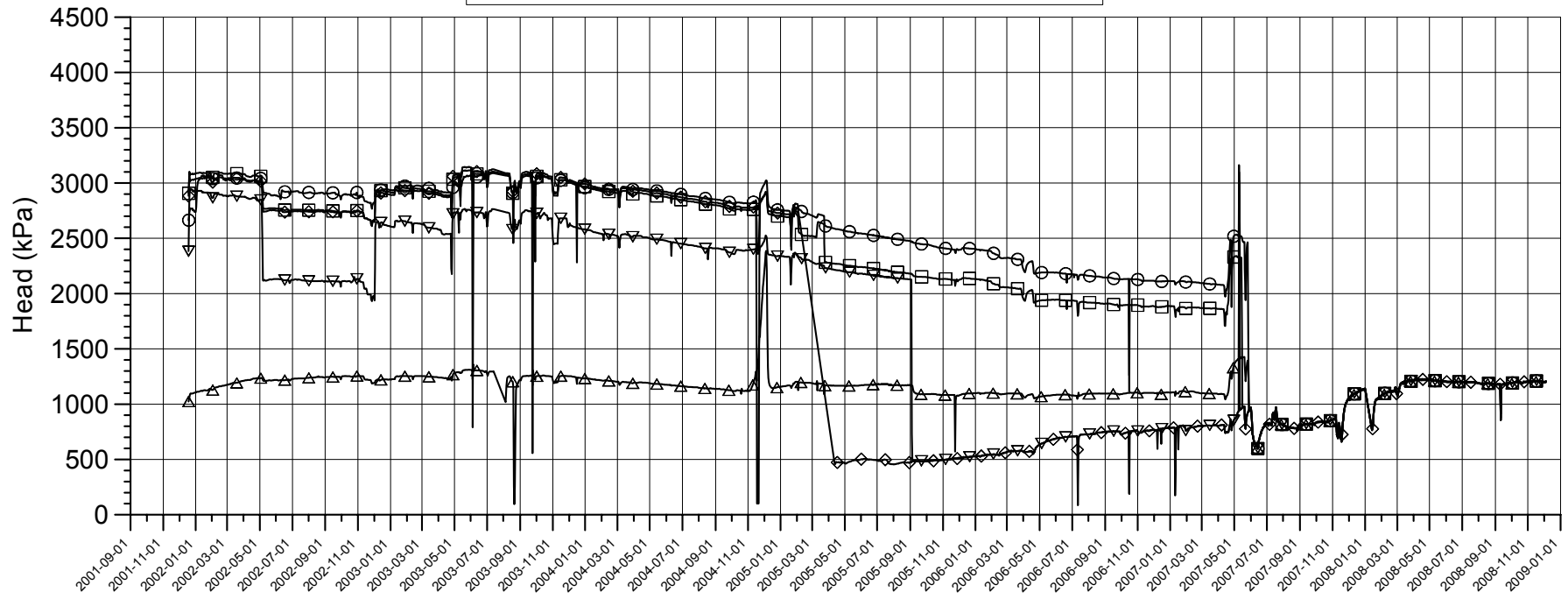

Events

- Start backfilling of section I 2001-09-03
- Stop backfilling of section I 2001-11-20
- Casting of inner plug finalized 2001-12-19
- Start backfilling of section II 2003-04-29
- Stop backfilling of section II 2003-06-27
- Casting of outer plug finalized 2003-09-11
- Start drilling of Fine Sealing Project 2007-03-12
- Start grouting of Fine Sealing Project 2007-11-19

Borehole sections

- ▽ — ▽ G02:1 19 m - 30 m
- ◇ — ◇ G02:2 16 m - 18 m
- — □ G02:3 12 m - 14 m
- — ○ G02:4 8 m - 11 m
- △ — △ G02:5 1.5 m - 6 m

KA3572G01 PRESSURE HEAD

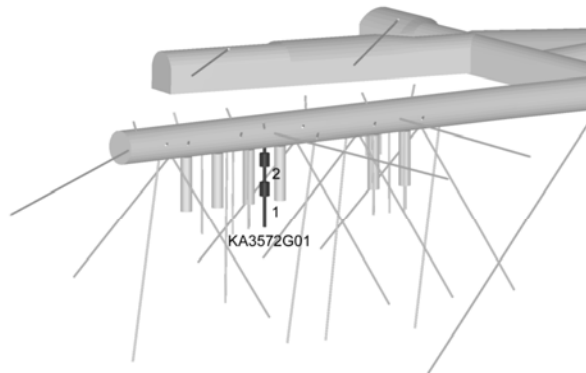
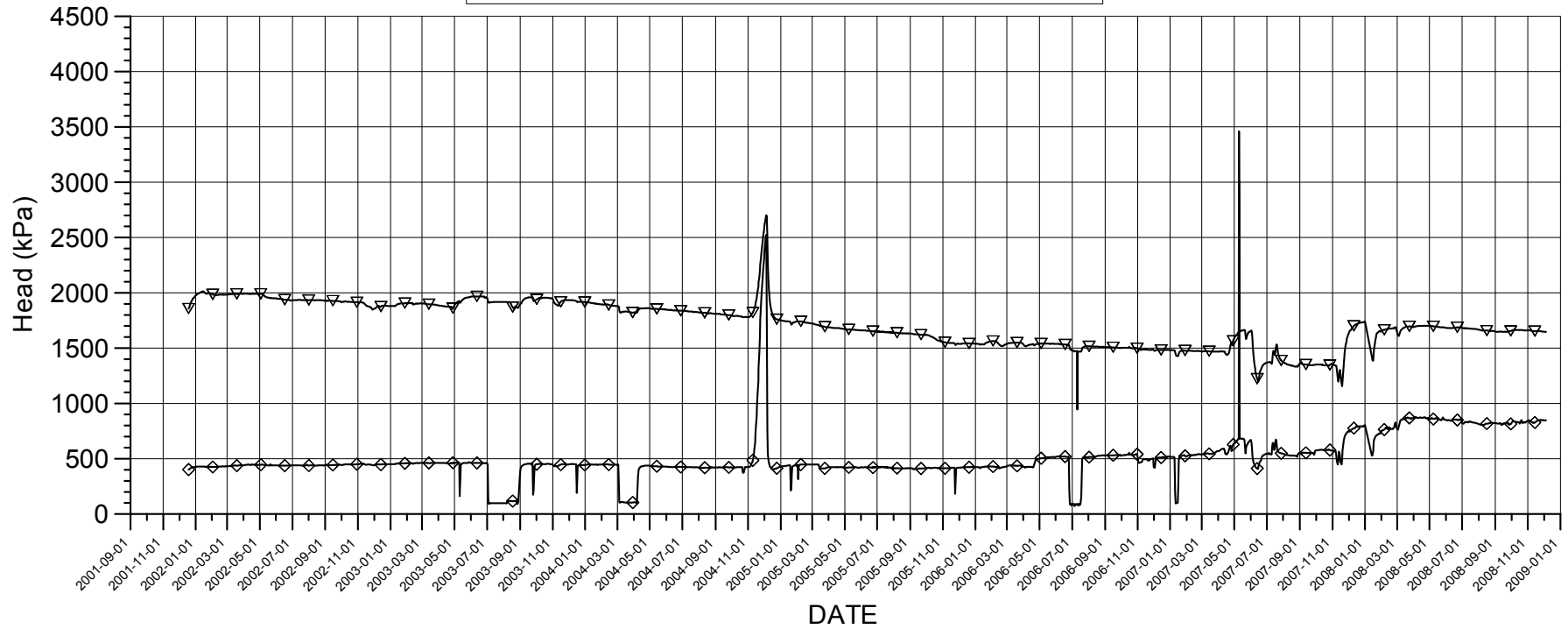

Events

- Start backfilling of section I 2001-09-03
- Stop backfilling of section I 2001-11-20
- Casting of inner plug finalized 2001-12-19
- Start backfilling of section II 2003-04-29
- Stop backfilling of section II 2003-06-27
- Casting of outer plug finalized 2003-09-11
- Start drilling of Fine Sealing Project 2007-03-12
- Start grouting of Fine Sealing Project 2007-11-19

Borehole sections

- ▽ — ▽ G01:1 7.3 m - 12.0 m
- ◇ — ◇ G01:2 2.7 m - 5.3 m

KA3573A PRESSURE HEAD

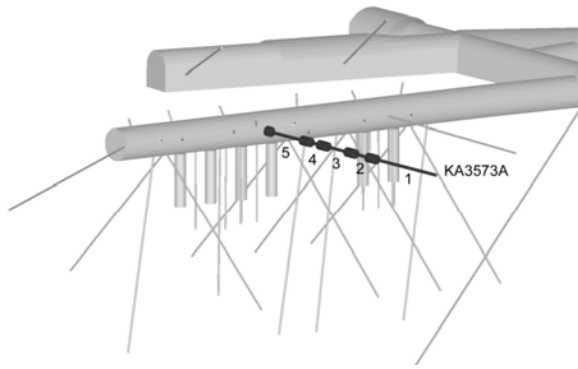
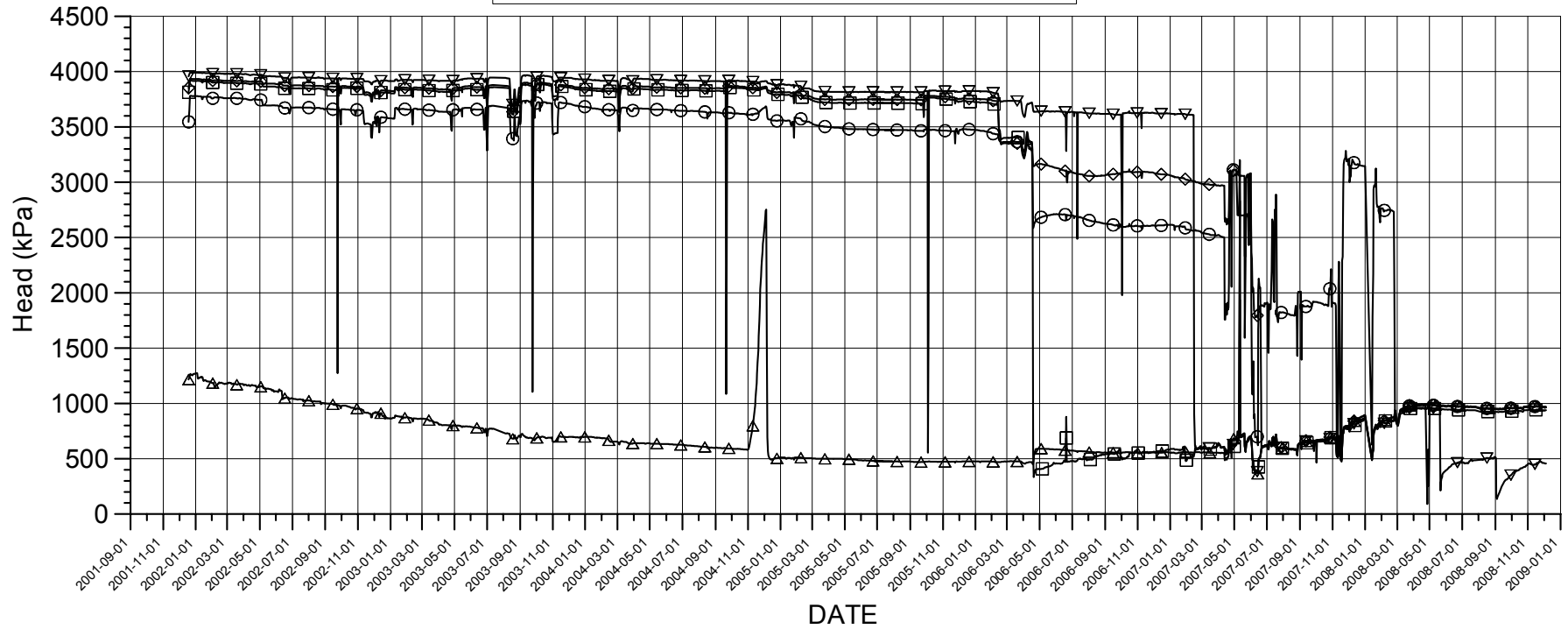

Events

- Start backfilling of section I 2001-09-03
- Stop backfilling of section I 2001-11-20
- Casting of inner plug finalized 2001-12-19
- Start backfilling of section II 2003-04-29
- Stop backfilling of section II 2003-06-27
- Casting of outer plug finalized 2003-09-11
- Start drilling of Fine Sealing Project 2007-03-12
- Start grouting of Fine Sealing Project 2007-11-19

Borehole sections

- ▽ A:1 26 m - 40.1 m
- ◇ A:2 21 m - 24 m
- A:3 14.5 m - 19 m
- A:4 10.5 m - 12.5 m
- △ A:5 3.4 m - 8.5 m

P_KA3573A.GRF 2008-12-10

KA3574G01 PRESSURE HEAD

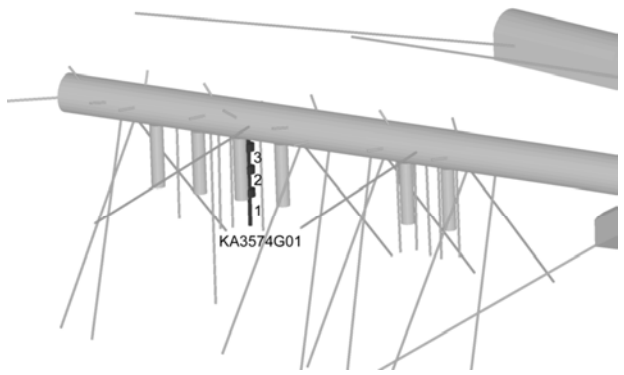
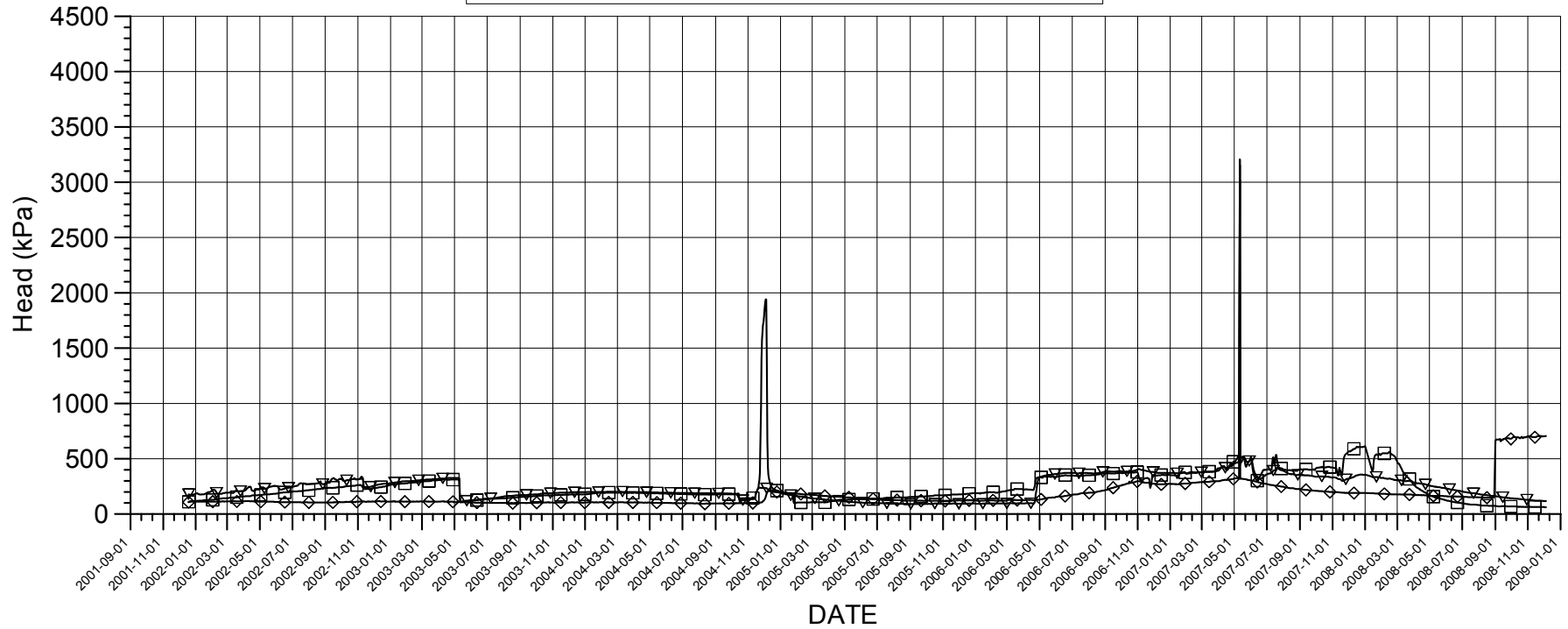

Events

- Start backfilling of section I 2001-09-03
- Stop backfilling of section I 2001-11-20
- Casting of inner plug finalized 2001-12-19
- Start backfilling of section II 2003-04-29
- Stop backfilling of section II 2003-06-27
- Casting of outer plug finalized 2003-09-11
- Start drilling of Fine Sealing Project 2007-03-12
- Start grouting of Fine Sealing Project 2007-11-19

Borehole sections

- ▽ — ▽ G01:1 8 m - 12 m
- ◇ — ◇ G01:2 5.1 m - 7 m
- — □ G01:3 1.8 m - 4.1 m

KA3576G01 PRESSURE HEAD

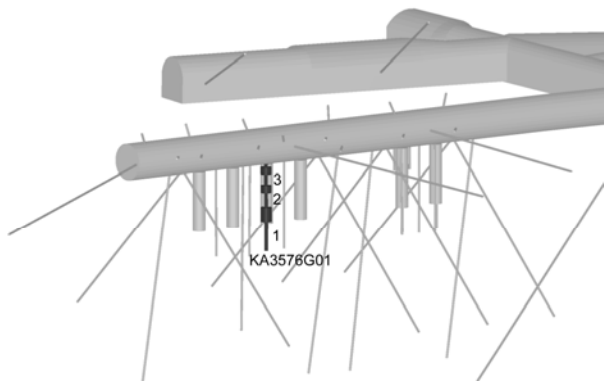
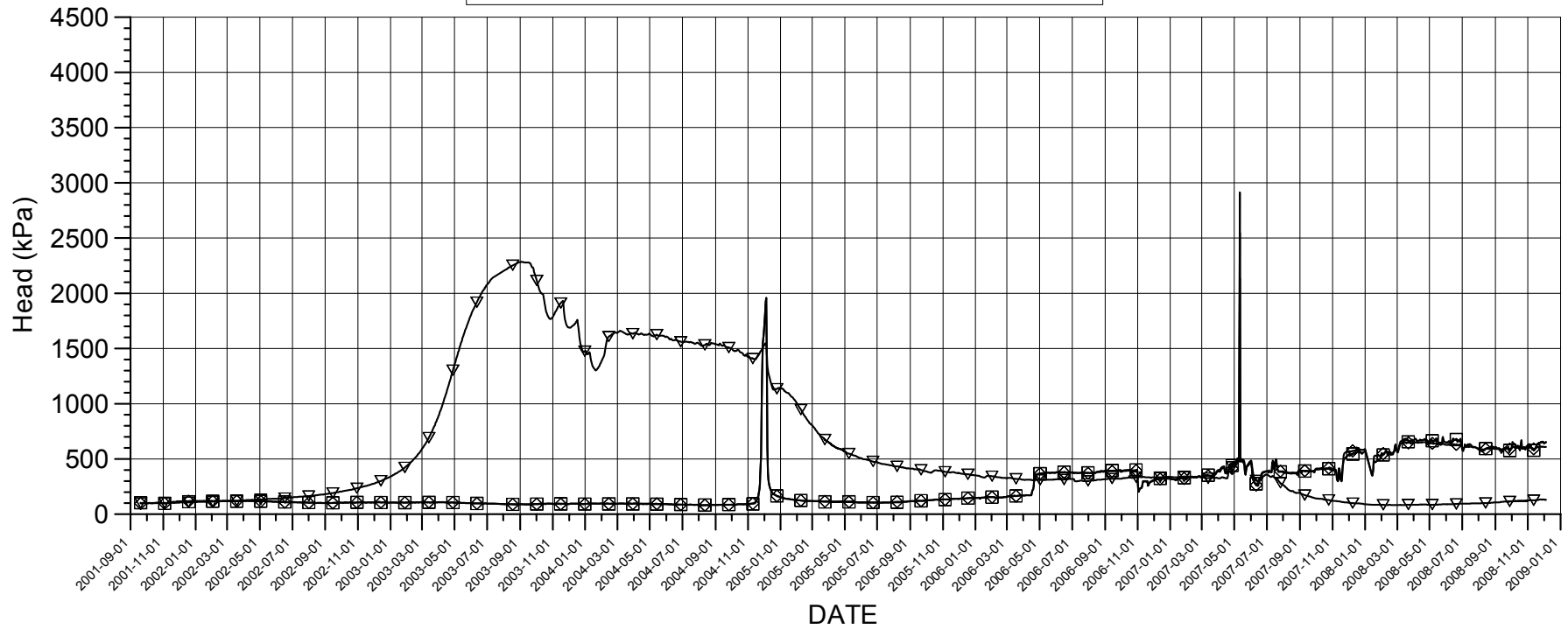

- Events**
- Start backfilling of section I 2001-09-03
 - Stop backfilling of section I 2001-11-20
 - Casting of inner plug finalized 2001-12-19
 - Start backfilling of section II 2003-04-29
 - Stop backfilling of section II 2003-06-27
 - Casting of outer plug finalized 2003-09-11
 - Start drilling of Fine Sealing Project 2007-03-12
 - Start grouting of Fine Sealing Project 2007-11-19

- Borehole sections**
- ▽ G01:1 7.9 m - 12 m
 - ◇ G01:2 3.9 m - 5.9 m
 - G01:3 1.4 m - 2.9 m

KA3578C01, KA3578H01, KA3579D01 PRESSURE HEAD

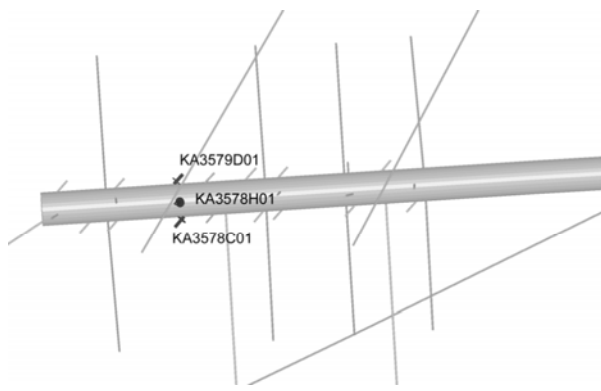
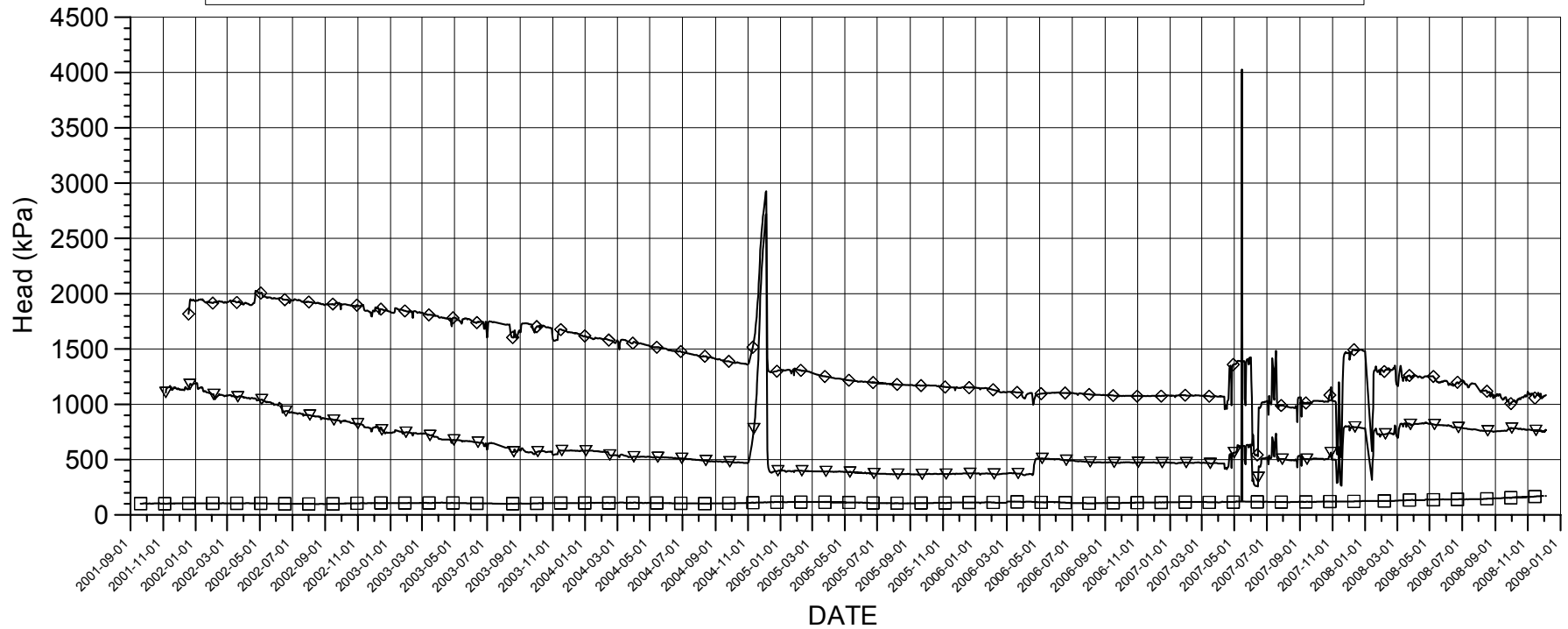

Events

- Start backfilling of section I 2001-09-03
- Stop backfilling of section I 2001-11-20
- Casting of inner plug finalized 2001-12-19
- Start backfilling of section II 2003-04-29
- Stop backfilling of section II 2003-06-27
- Casting of outer plug finalized 2003-09-11
- Start drilling of Fine Sealing Project 2007-03-12
- Start grouting of Fine Sealing Project 2007-11-19

Borehole sections

- ▽ KA3578C01:1 0.65 m - 2 m
- ◇ KA3578H01:1 0.65 m - 2 m
- KA3579D01:1 0.65 m - 2 m

KA3578G01 PRESSURE HEAD

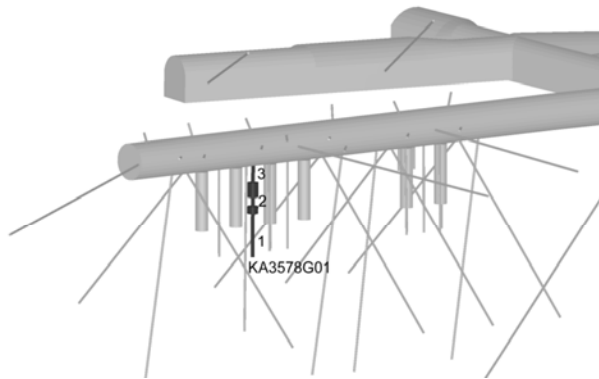
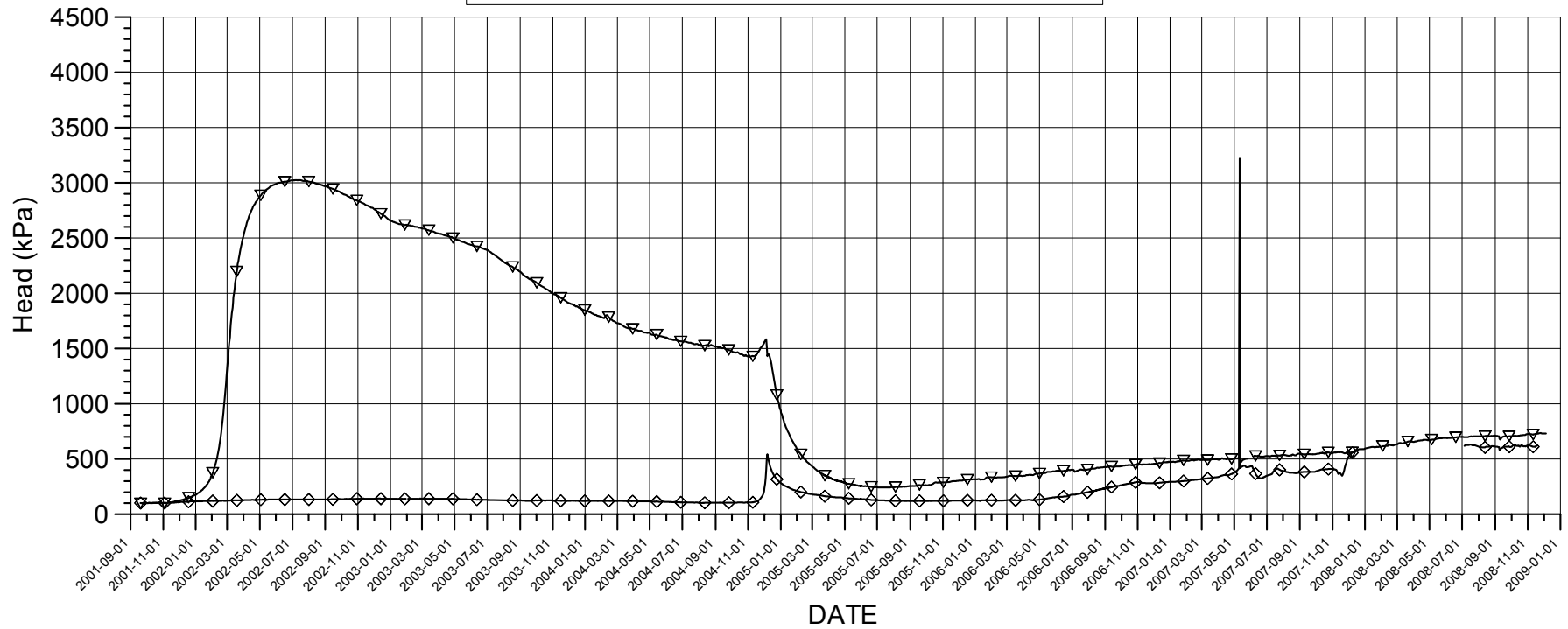

Events

- Start backfilling of section I 2001-09-03
- Stop backfilling of section I 2001-11-20
- Casting of inner plug finalized 2001-12-19
- Start backfilling of section II 2003-04-29
- Stop backfilling of section II 2003-06-27
- Casting of outer plug finalized 2003-09-11
- Start drilling of Fine Sealing Project 2007-03-12
- Start grouting of Fine Sealing Project 2007-11-19

Borehole sections

- ▽ — ▽ G01:1 6.5 m - 12.6 m
- ◇ — ◇ G01:2 4.3 m - 5.5 m

KA3579G PRESSURE HEAD

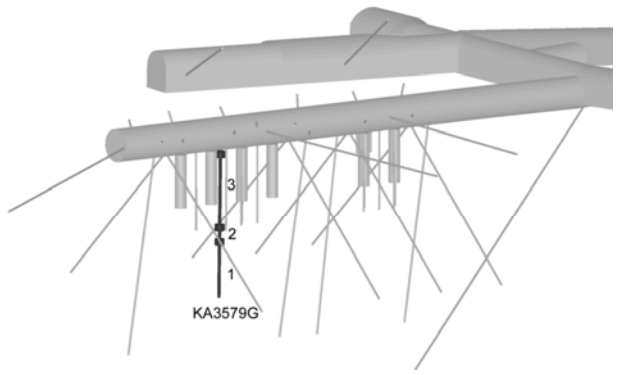
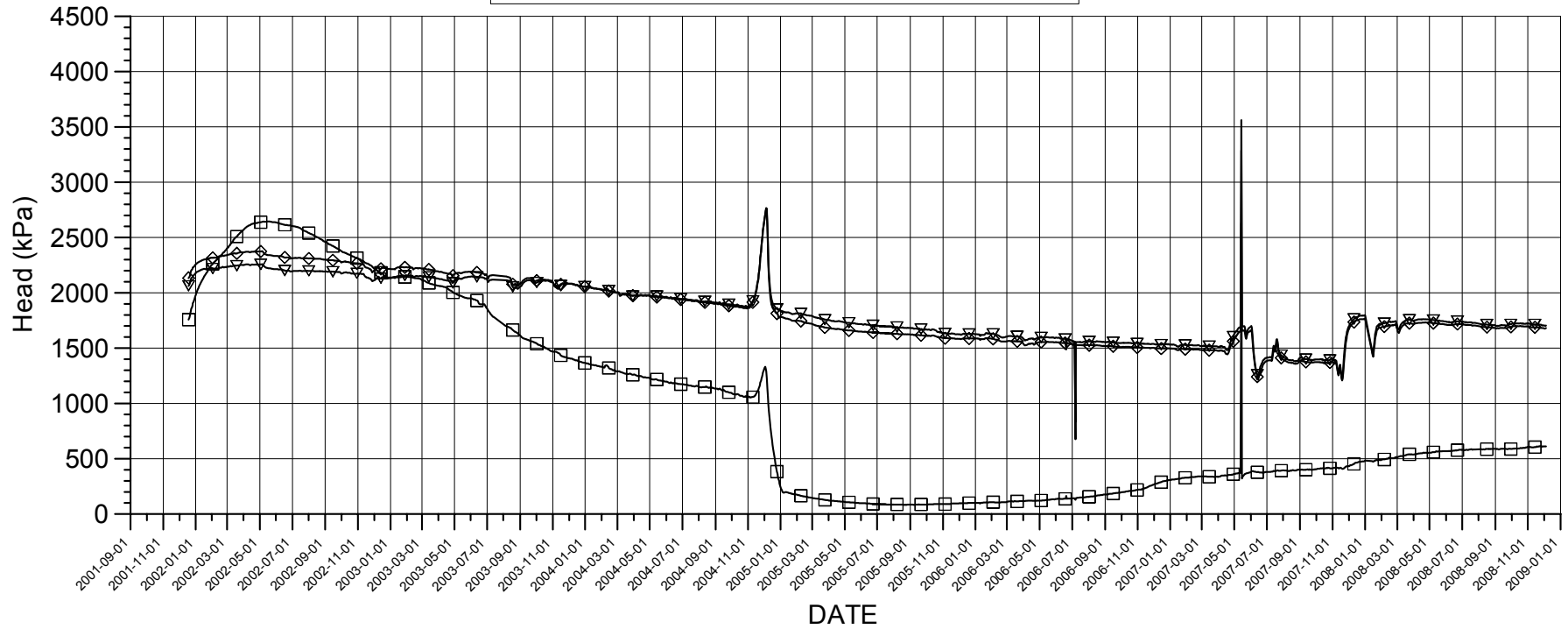

Events

- Start backfilling of section I 2001-09-03
- Stop backfilling of section I 2001-11-20
- Casting of inner plug finalized 2001-12-19
- Start backfilling of section II 2003-04-29
- Stop backfilling of section II 2003-06-27
- Casting of outer plug finalized 2003-09-11
- Start drilling of Fine Sealing Project 2007-03-12
- Start grouting of Fine Sealing Project 2007-11-19

Borehole sections

- ▽ — ▽ G:1 14.7 m - 22.7 m
- ◇ — ◇ G:2 12.5 m - 13.7 m
- — □ G:3 2.5 m - 11.5 m

KA3584G01 PRESSURE HEAD

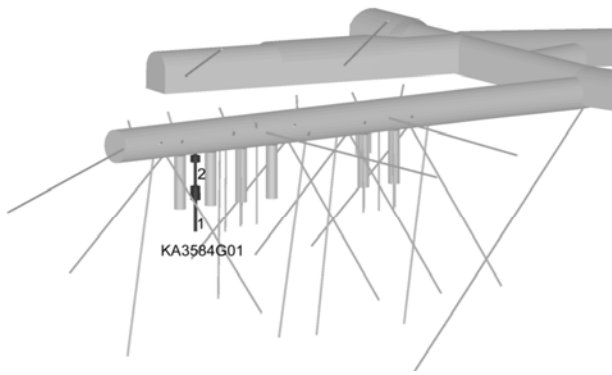
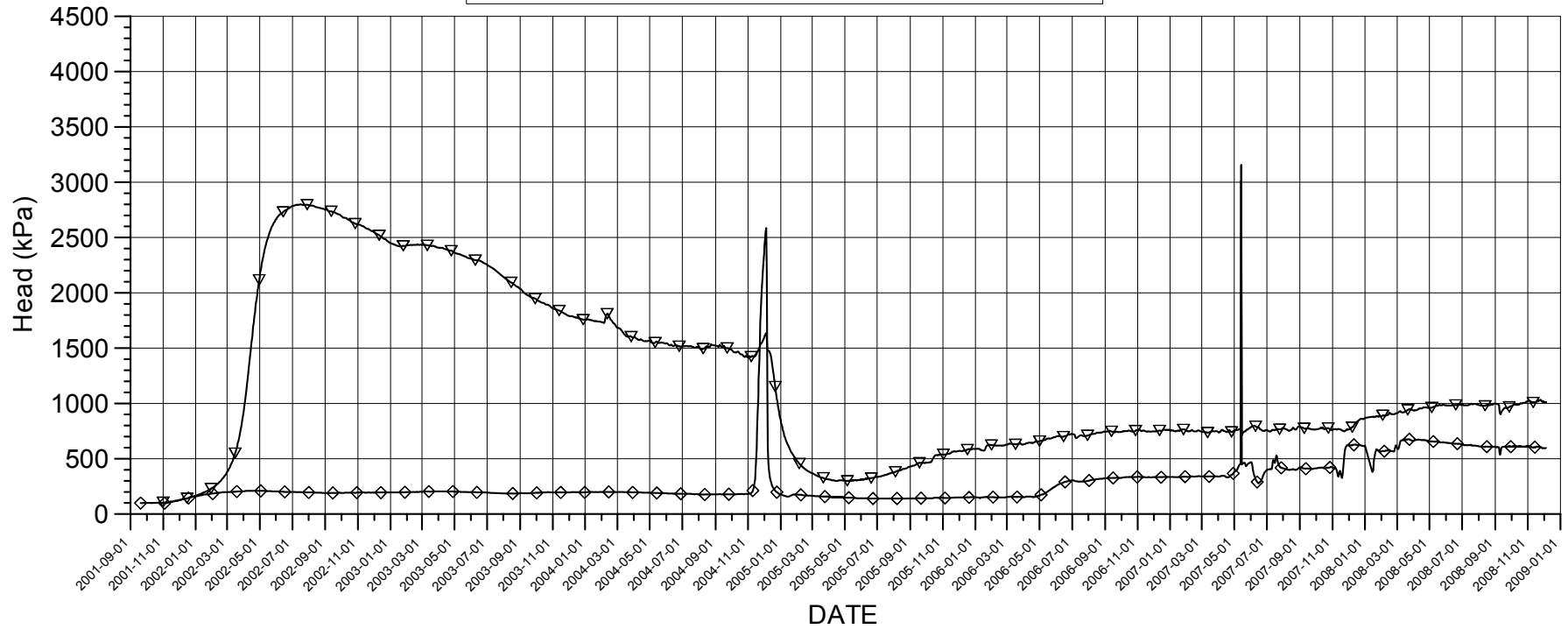

- Events**
- Start backfilling of section I 2001-09-03
 - Stop backfilling of section I 2001-11-20
 - Casting of inner plug finalized 2001-12-19
 - Start backfilling of section II 2003-04-29
 - Stop backfilling of section II 2003-06-27
 - Casting of outer plug finalized 2003-09-11
 - Start drilling of Fine Sealing Project 2007-03-12
 - Start grouting of Fine Sealing Project 2007-11-19

- Borehole sections**
- ▽ G01:1 7 m - 12 m
 - ◇ G01:2 1.4 m - 5 m

KA3588C01, KA3588D01, KA3588I01 PRESSURE HEAD

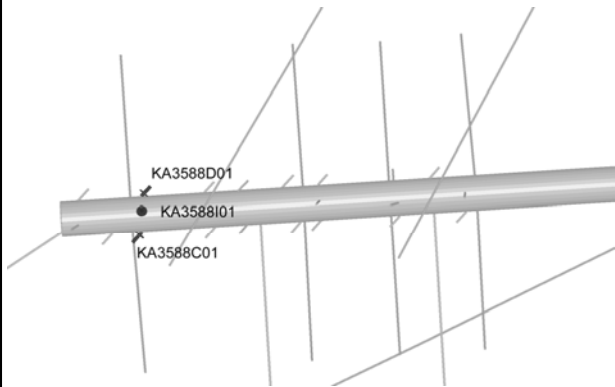
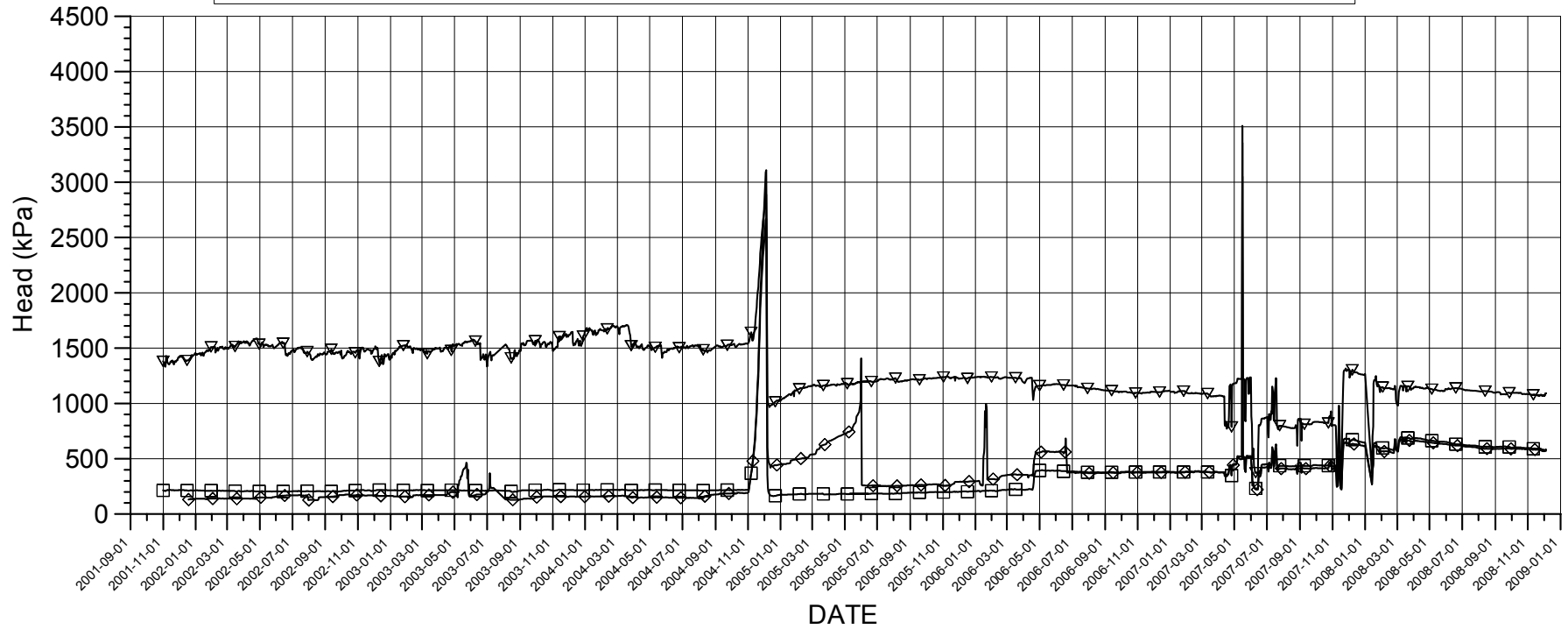

Events

- Start backfilling of section I 2001-09-03
- Stop backfilling of section I 2001-11-20
- Casting of inner plug finalized 2001-12-19
- Start backfilling of section II 2003-04-29
- Stop backfilling of section II 2003-06-27
- Casting of outer plug finalized 2003-09-11
- Start drilling of Fine Sealing Project 2007-03-12
- Start grouting of Fine Sealing Project 2007-11-19

Borehole sections

- ▽ KA3588C01:1 0.65 m - 2 m
- ◇ KA3588D01:1 0.65 m - 2 m
- KA3588I01:1 0.65 m - 2 m

KA3590G01 PRESSURE HEAD

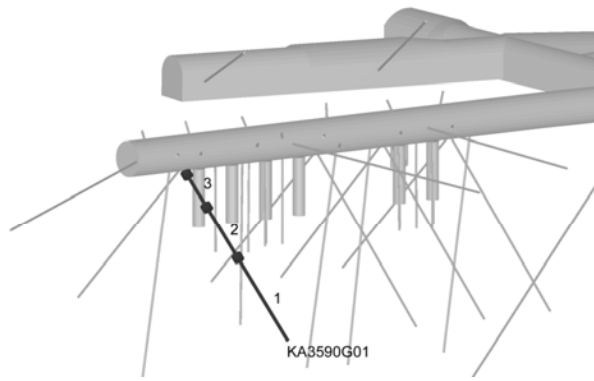
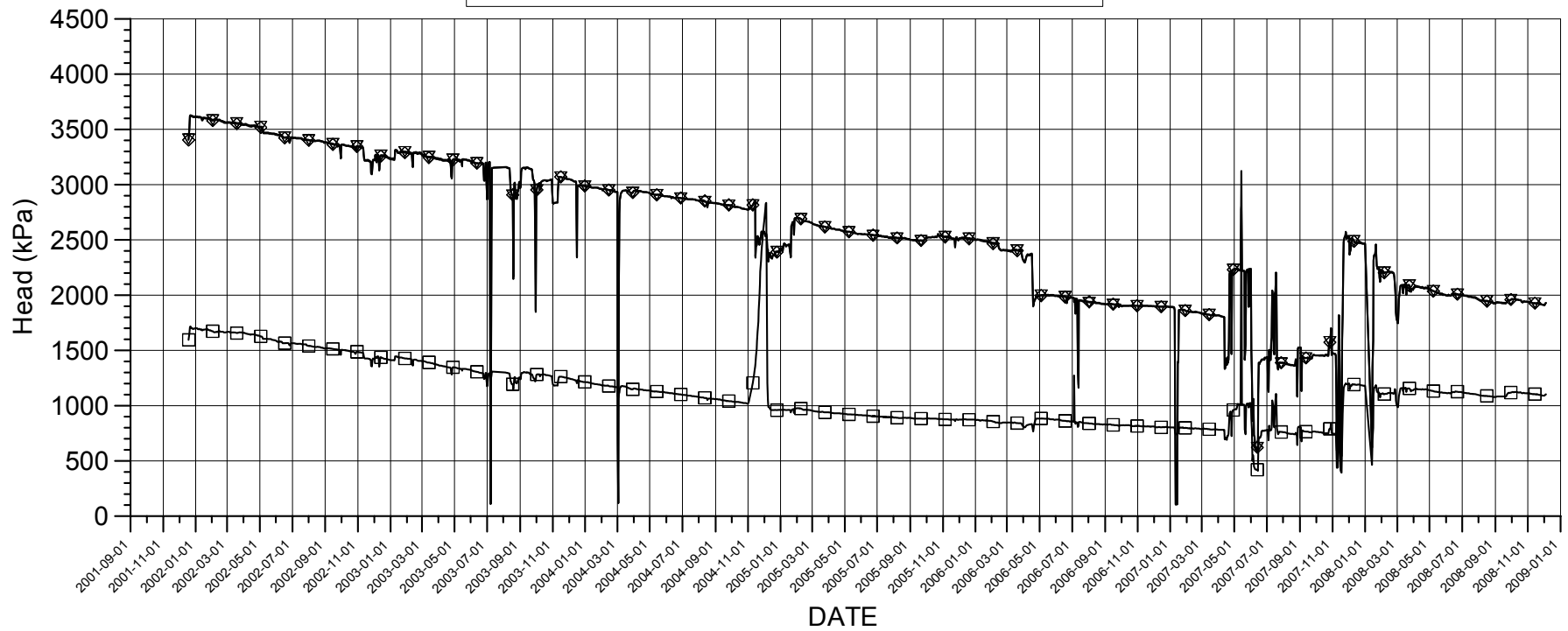

Events

- Start backfilling of section I 2001-09-03
- Stop backfilling of section I 2001-11-20
- Casting of inner plug finalized 2001-12-19
- Start backfilling of section II 2003-04-29
- Stop backfilling of section II 2003-06-27
- Casting of outer plug finalized 2003-09-11
- Start drilling of Fine Sealing Project 2007-03-12
- Start grouting of Fine Sealing Project 2007-11-19

Borehole sections

- ▽ G01:1 16 m - 30 m
- ◇ G01:2 7 m - 15 m
- G01:3 1.5 m - 6 m

KA3590G02 PRESSURE HEAD

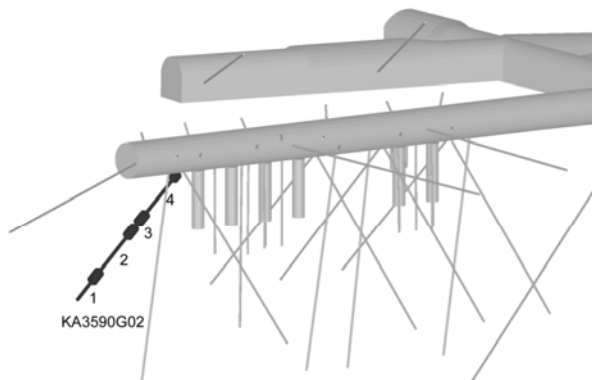
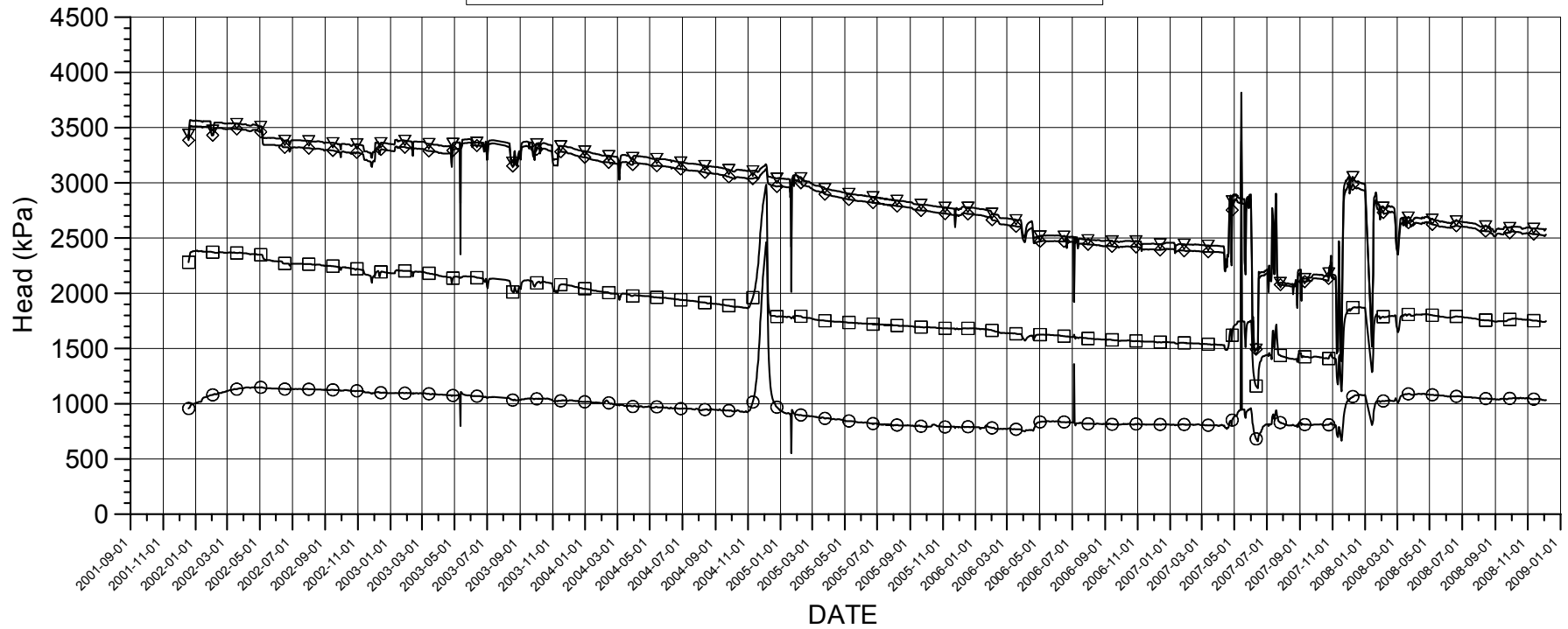

Events

- Start backfilling of section I 2001-09-03
- Stop backfilling of section I 2001-11-20
- Casting of inner plug finalized 2001-12-19
- Start backfilling of section II 2003-04-29
- Stop backfilling of section II 2003-06-27
- Casting of outer plug finalized 2003-09-11
- Start drilling of Fine Sealing Project 2007-03-12
- Start grouting of Fine Sealing Project 2007-11-19

Borehole sections

- ▽ G02:1 25.65 m - 30 m
- ◇ G02:2 15.35 m - 23.65 m
- G02:3 12.05 m - 13.35 m
- G02:4 1.65 m - 10.05 m

KA3592C01, KA3597D01, KA3597H01 PRESSURE HEAD

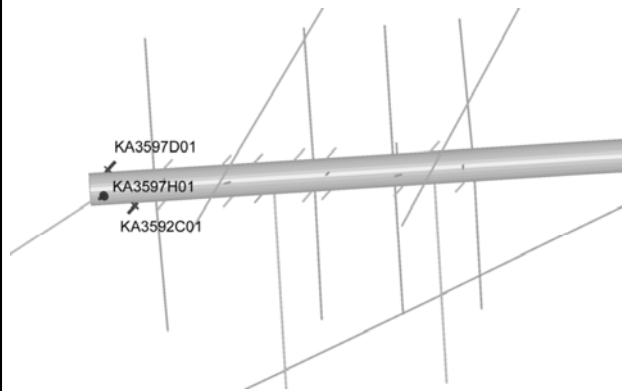
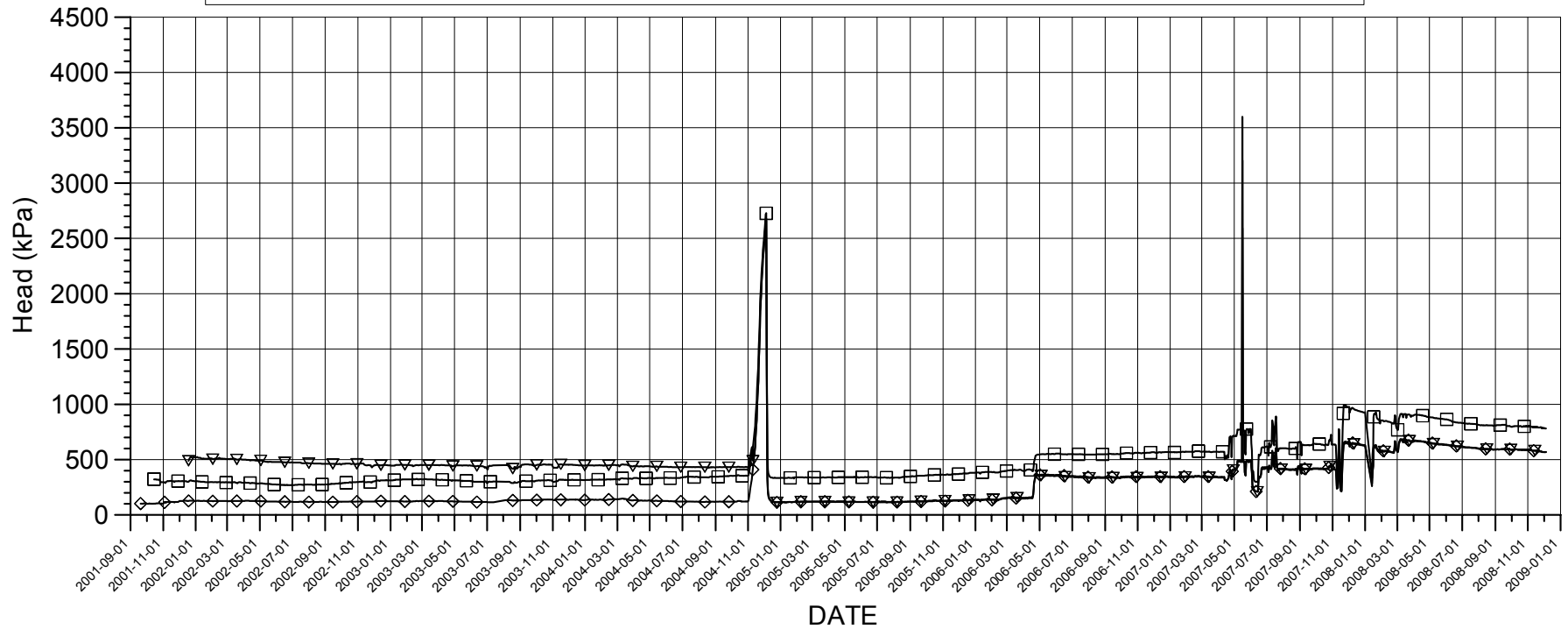

Events

- Start backfilling of section I 2001-09-03
- Stop backfilling of section I 2001-11-20
- Casting of inner plug finalized 2001-12-19
- Start backfilling of section II 2003-04-29
- Stop backfilling of section II 2003-06-27
- Casting of outer plug finalized 2003-09-11
- Start drilling of Fine Sealing Project 2007-03-12
- Start grouting of Fine Sealing Project 2007-11-19

Borehole sections

- ▽ KA3592C01:1 0.65 m - 2 m
- ◇ KA3597D01:1 0.65 m - 2 m
- KA3597H01:1 0.65 m - 2 m

KA3593G PRESSURE HEAD

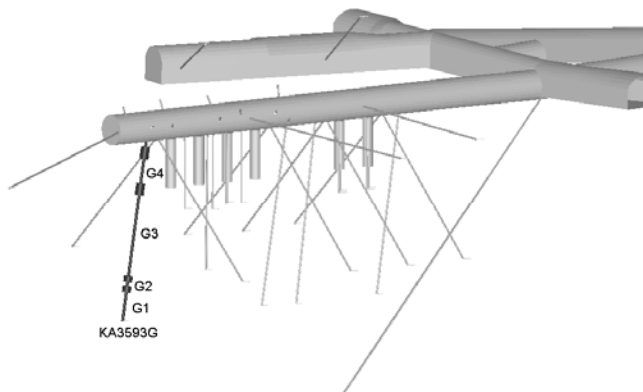
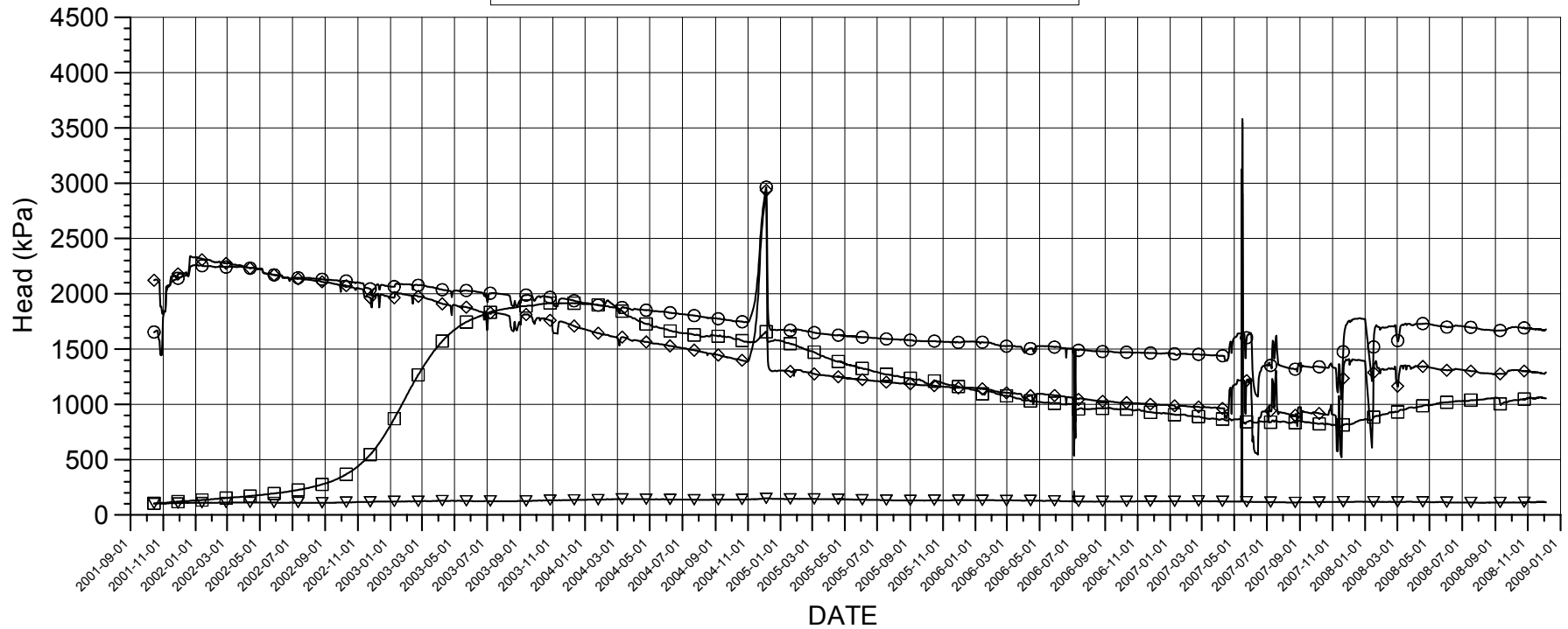

Events

- Start backfilling of section I 2001-09-03
- Stop backfilling of section I 2001-11-20
- Casting of inner plug finalized 2001-12-19
- Start backfilling of section II 2003-04-29
- Stop backfilling of section II 2003-06-27
- Casting of outer plug finalized 2003-09-11
- Start drilling of Fine Sealing Project 2007-03-12
- Start grouting of Fine Sealing Project 2007-11-19

Borehole sections

- ▽ — ▽ G:1 25.2 m - 30 m
- ◇ — ◇ G:2 23.5 m - 24.2 m
- — □ G:3 9 m - 22.5 m
- — ○ G:4 3 m - 7 m

KA3600F PRESSURE HEAD

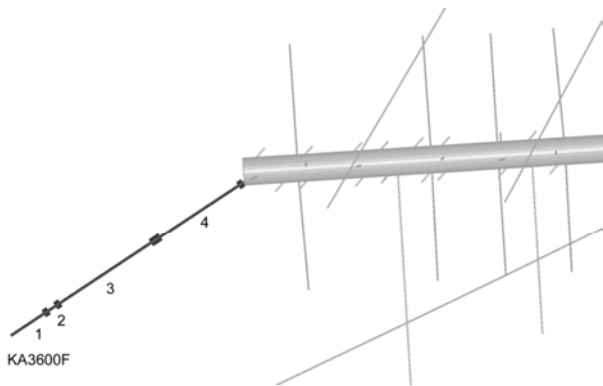
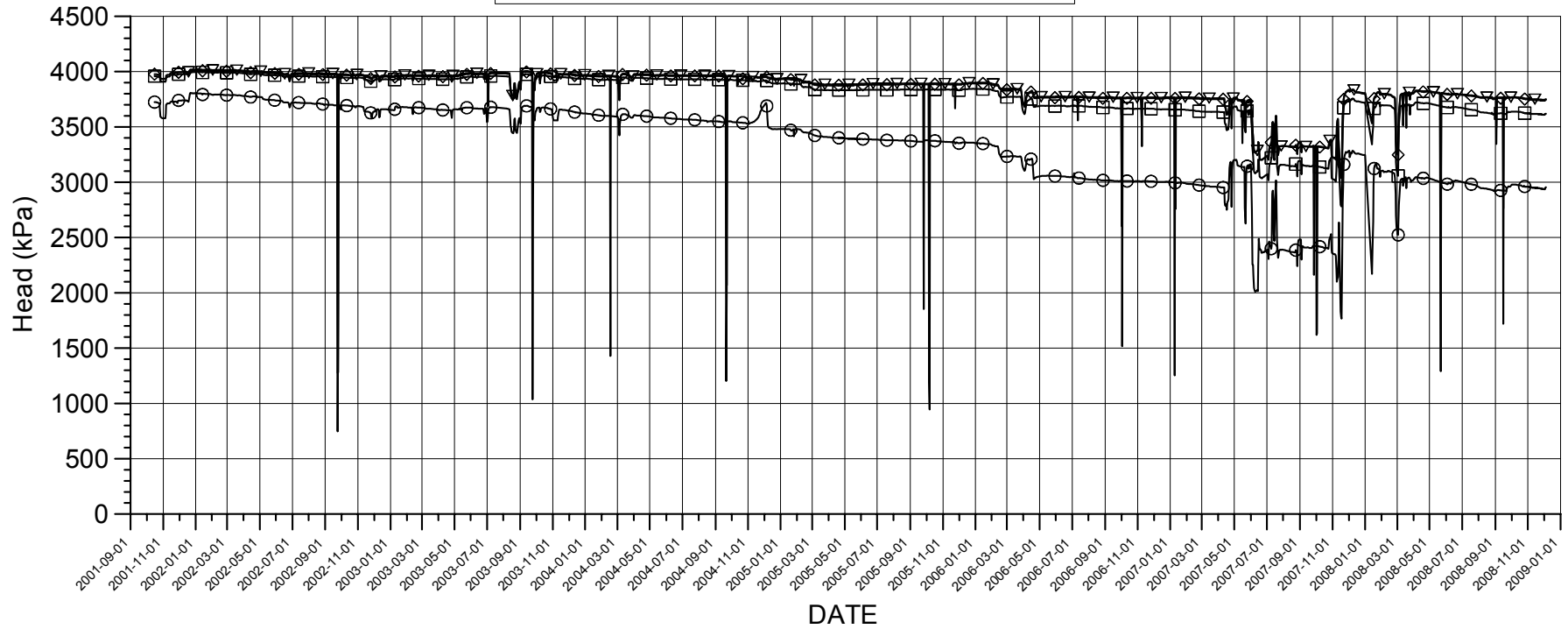

Events

- Start backfilling of section I 2001-09-03
- Stop backfilling of section I 2001-11-20
- Casting of inner plug finalized 2001-12-19
- Start backfilling of section II 2003-04-29
- Stop backfilling of section II 2003-06-27
- Casting of outer plug finalized 2003-09-11
- Start drilling of Fine Sealing Project 2007-03-12
- Start grouting of Fine Sealing Project 2007-11-19

Borehole sections

- ▽ F:1 43 m - 50.1 m
- ◇ F:2 40.5 m - 42 m
- F:3 20 m - 39.5 m
- F:4 3.4 m - 18 m

KG0021A01 PRESSURE HEAD

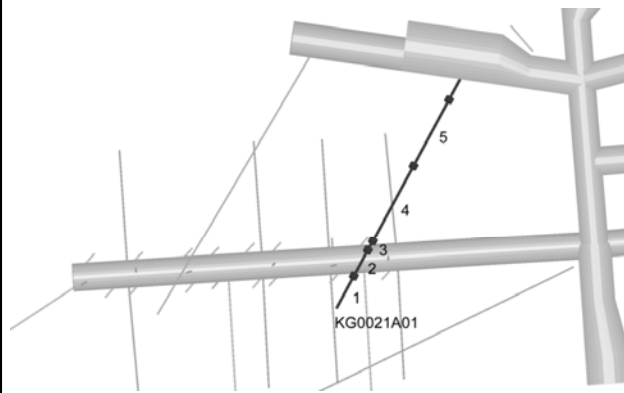
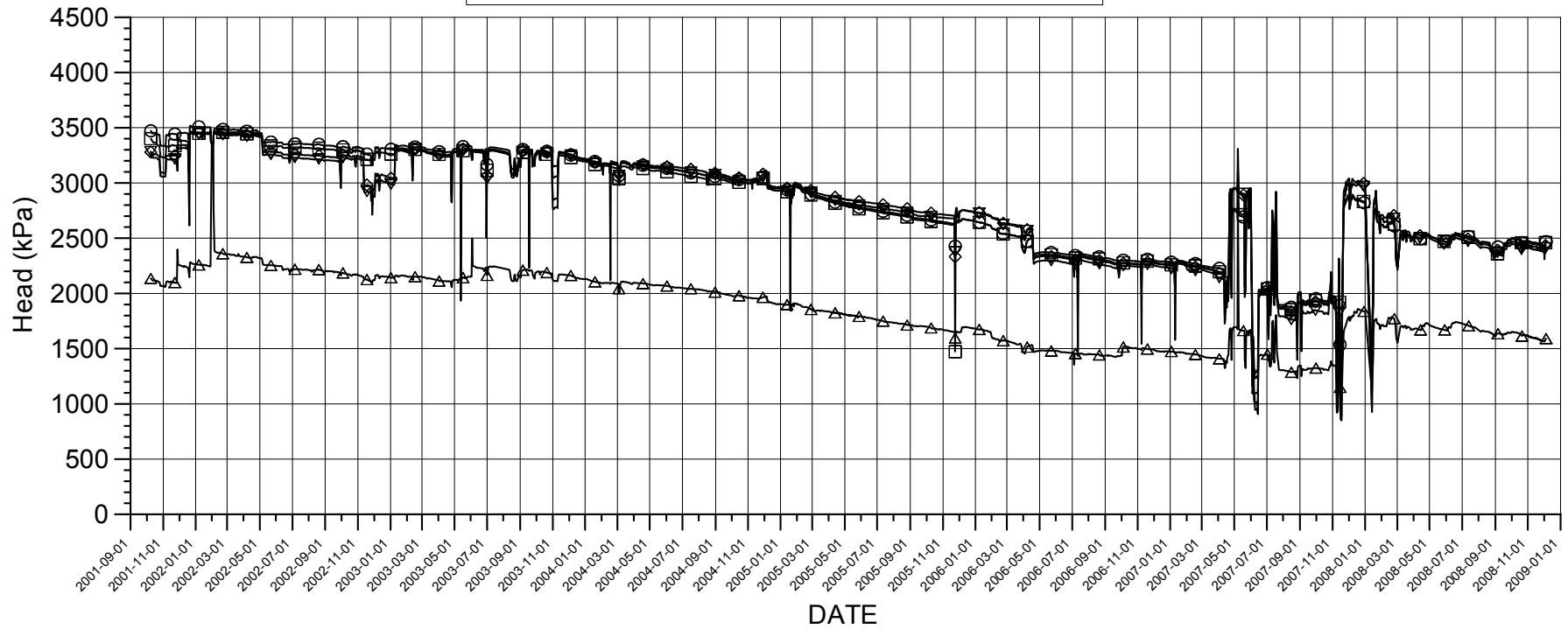

Events

- Start backfilling of section I 2001-09-03
- Stop backfilling of section I 2001-11-20
- Casting of inner plug finalized 2001-12-19
- Start backfilling of section II 2003-04-29
- Stop backfilling of section II 2003-06-27
- Casting of outer plug finalized 2003-09-11
- Start drilling of Fine Sealing Project 2007-03-12
- Start grouting of Fine Sealing Project 2007-11-19

Borehole sections

- ▽ A01:1 42.5 m - 48.82 m
- ◇ A01:2 37 m - 41.5 m
- A01:3 35 m - 36 m
- A01:4 19 m - 34 m
- △ A01:5 5 m - 18 m

P_KG0021A01.GRF 2008-12-10

KG0048A01 PRESSURE HEAD

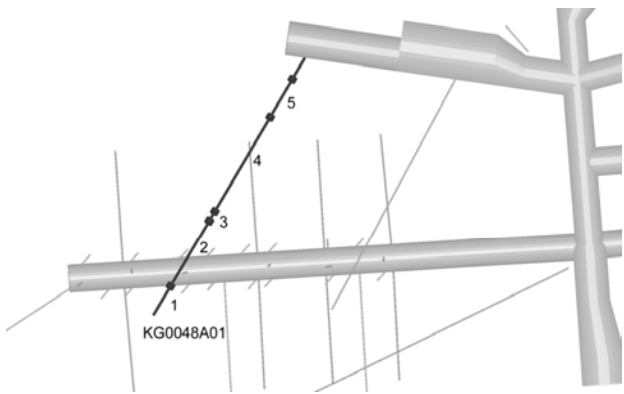
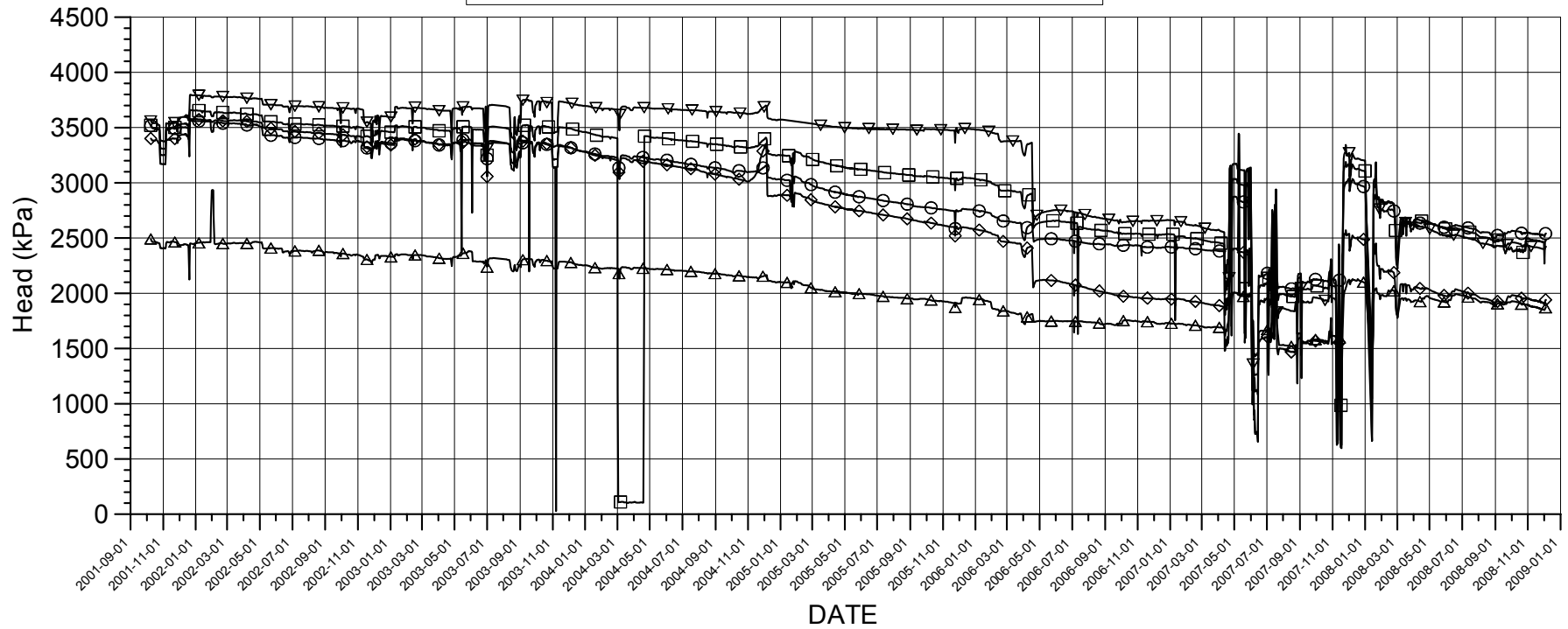

Events

- Start backfilling of section I 2001-09-03
- Stop backfilling of section I 2001-11-20
- Casting of inner plug finalized 2001-12-19
- Start backfilling of section II 2003-04-29
- Stop backfilling of section II 2003-06-27
- Casting of outer plug finalized 2003-09-11
- Start drilling of Fine Sealing Project 2007-03-12
- Start grouting of Fine Sealing Project 2007-11-19

Borehole sections

- ▽ A01:1 49 m - 54.69 m
- ◇ A01:2 34.8 m - 48 m
- A01:3 32.8 m - 33.8 m
- A01:4 13 m - 31.8 m
- △ A01:5 5 m - 12 m

P_KG0048A01.GRF 2008-12-10

MA3515G WEIR FLOW

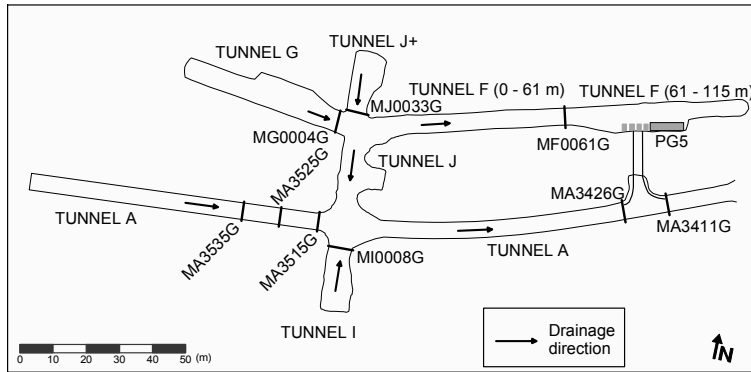
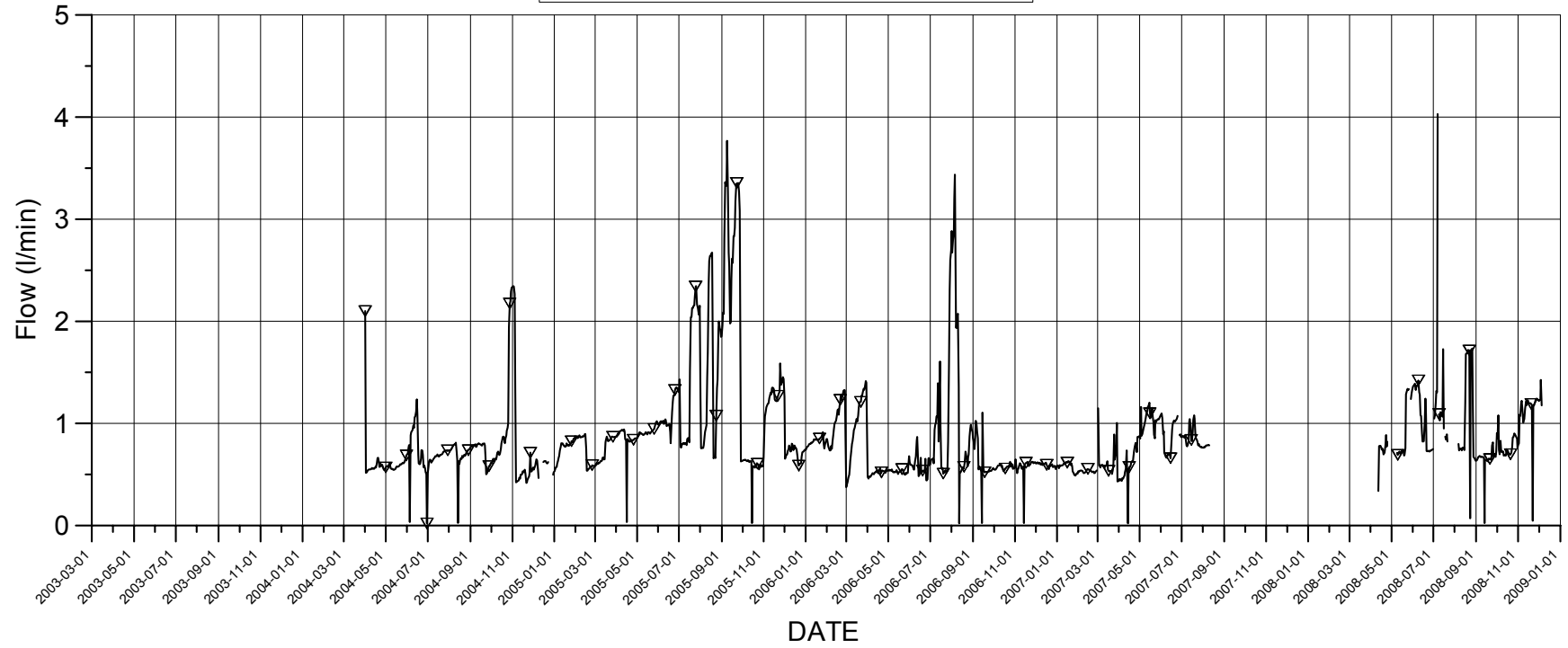

Events

- Start backfilling of section I 2001-09-03
- Stop backfilling of section I 2001-11-20
- Casting of inner plug finalized 2001-12-19
- Start backfilling of section II 2003-04-29
- Stop backfilling of section II 2003-06-27
- Casting of outer plug finalized 2003-09-11
- Start drilling of Fine Sealing Project 2007-03-12
- Start grouting of Fine Sealing Project 2007-11-19



MA3525G WEIR FLOW

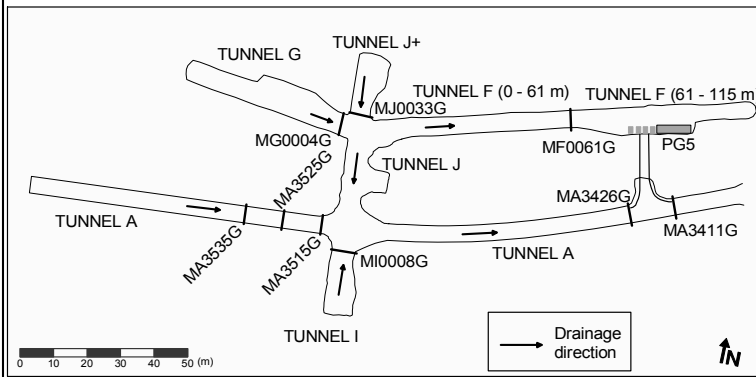
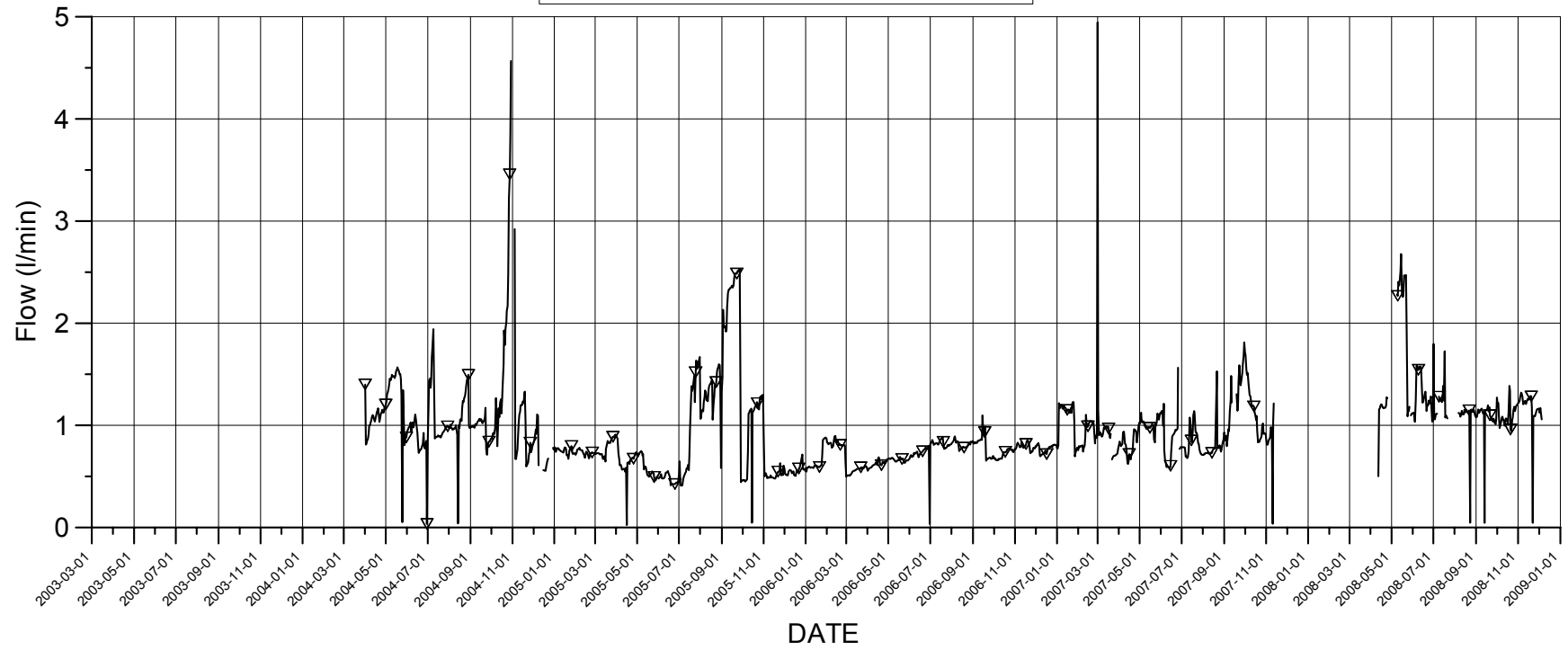

Events

- Start backfilling of section I 2001-09-03
- Stop backfilling of section I 2001-11-20
- Casting of inner plug finalized 2001-12-19
- Start backfilling of section II 2003-04-29
- Stop backfilling of section II 2003-06-27
- Casting of outer plug finalized 2003-09-11
- Start drilling of Fine Sealing Project 2007-03-12
- Start grouting of Fine Sealing Project 2007-11-19



MA3535G WEIR FLOW

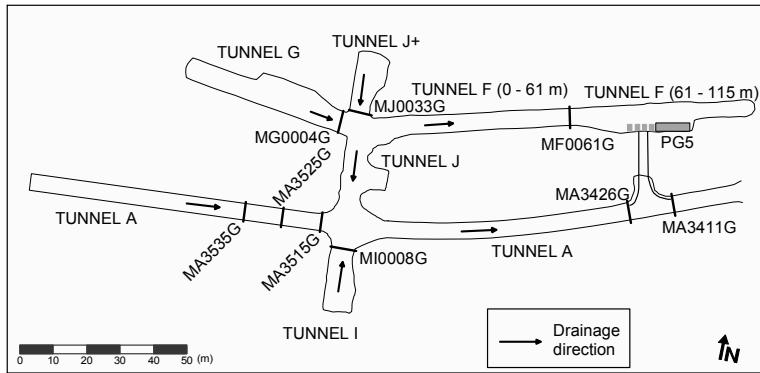
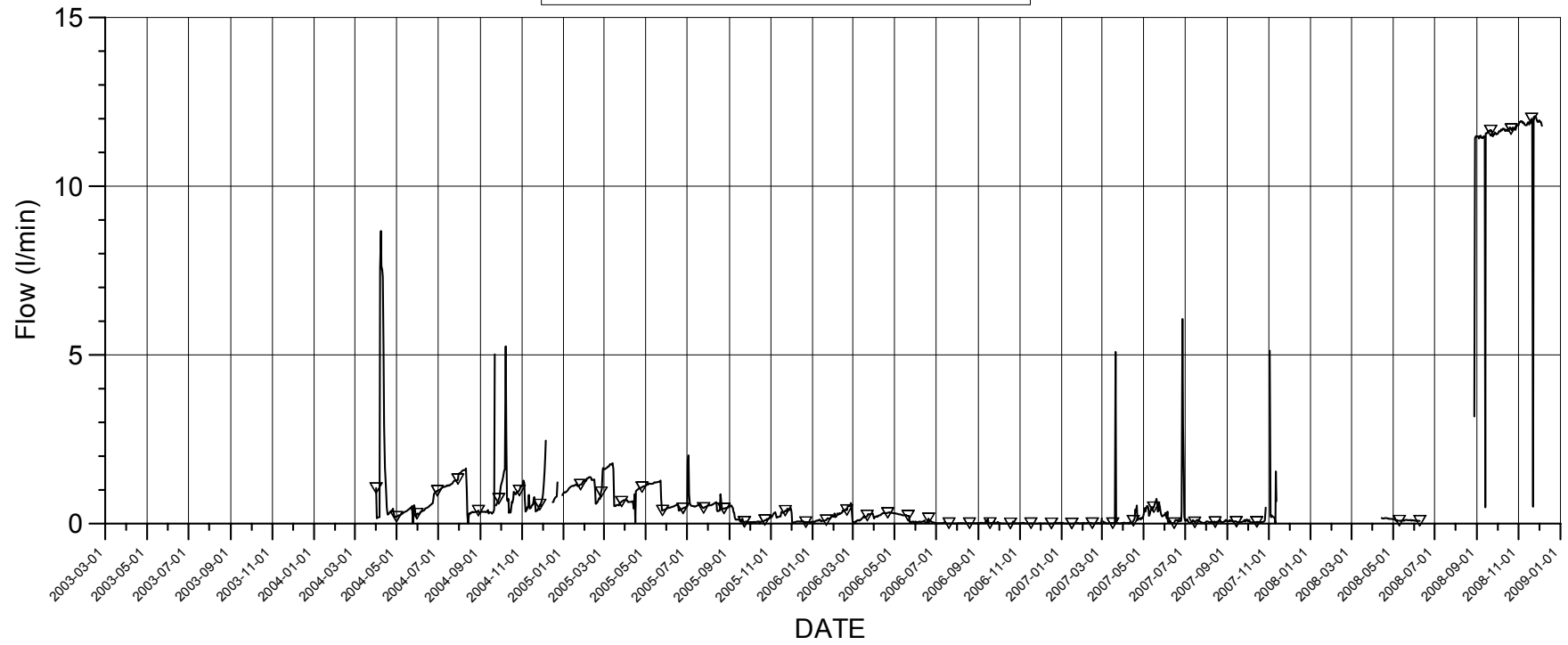

- ### Events
- Start backfilling of section I 2001-09-03
 - Stop backfilling of section I 2001-11-20
 - Casting of inner plug finalized 2001-12-19
 - Start backfilling of section II 2003-04-29
 - Stop backfilling of section II 2003-06-27
 - Casting of outer plug finalized 2003-09-11
 - Start drilling of Fine Sealing Project 2007-03-12
 - Start grouting of Fine Sealing Project 2007-11-19

▽ — ▽ WEIR MA3535G

MA3426G WEIR FLOW

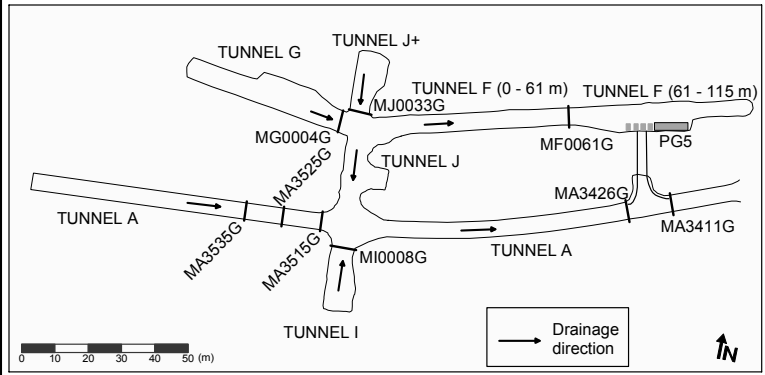
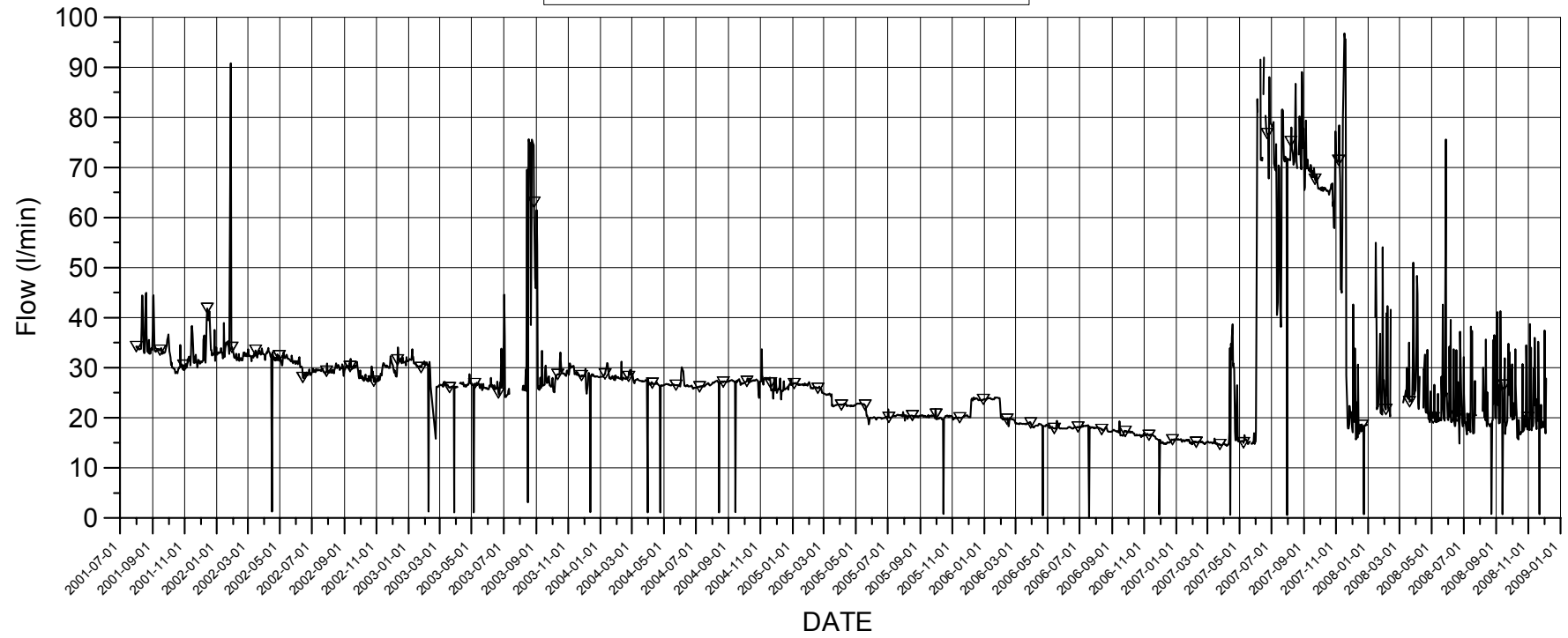

- ### Events
- Start backfilling of section I 2001-09-03
 - Stop backfilling of section I 2001-11-20
 - Casting of inner plug finalized 2001-12-19
 - Start backfilling of section II 2003-04-29
 - Stop backfilling of section II 2003-06-27
 - Casting of outer plug finalized 2003-09-11
 - Start drilling of Fine Sealing Project 2007-03-12
 - Start grouting of Fine Sealing Project 2007-11-19



MF0061G WEIR FLOW

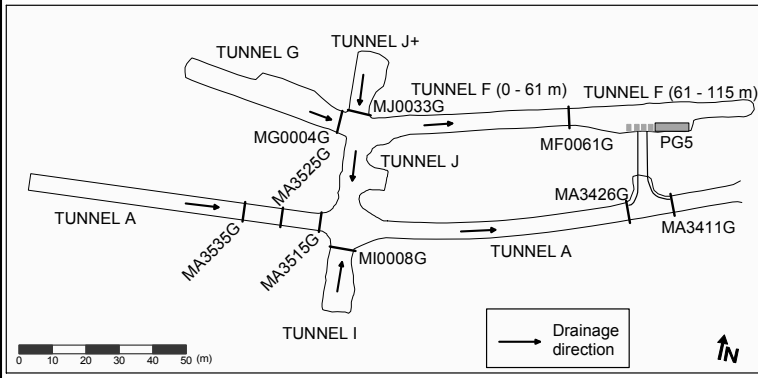
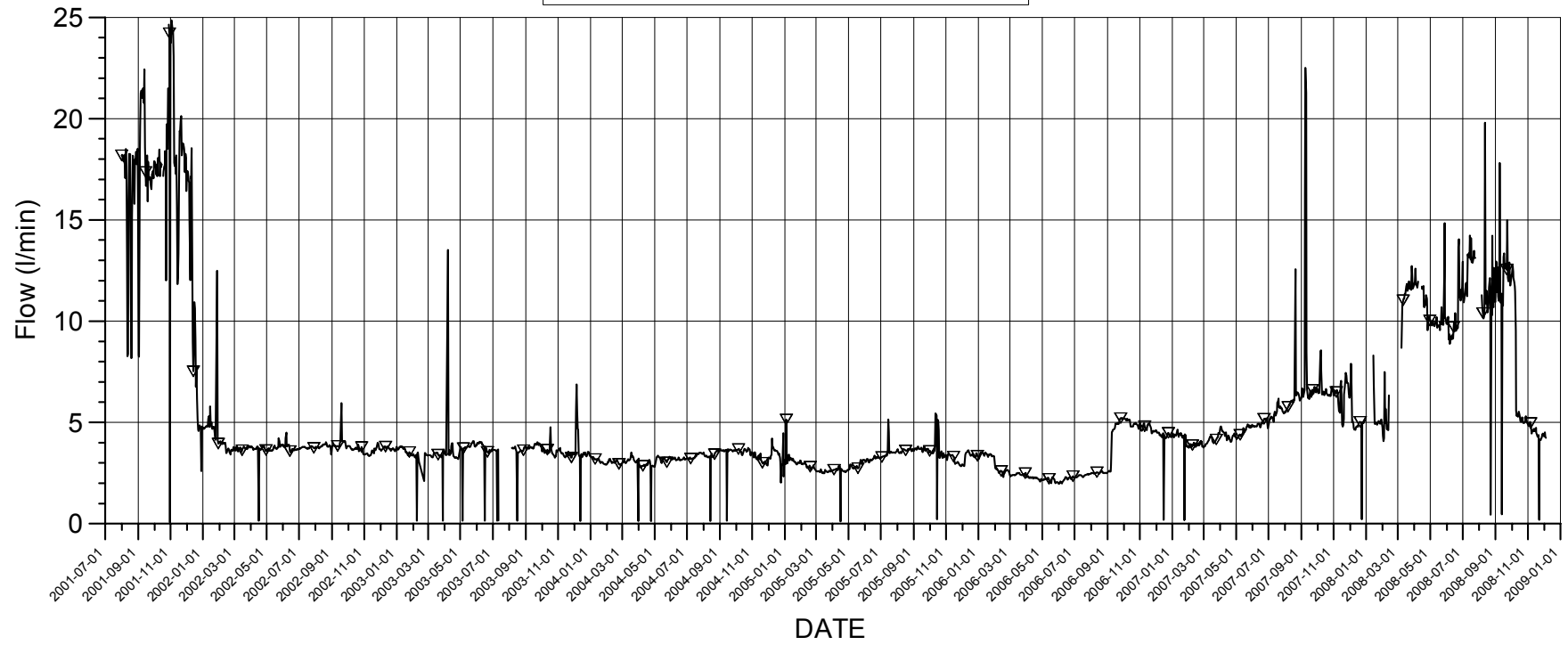

Events

- Start backfilling of section I 2001-09-03
- Stop backfilling of section I 2001-11-20
- Casting of inner plug finalized 2001-12-19
- Start backfilling of section II 2003-04-29
- Stop backfilling of section II 2003-06-27
- Casting of outer plug finalized 2003-09-11
- Start drilling of Fine Sealing Project 2007-03-12
- Start grouting of Fine Sealing Project 2007-11-19

▽ — ▽ WEIR MF0061G

MG0004G WEIR FLOW

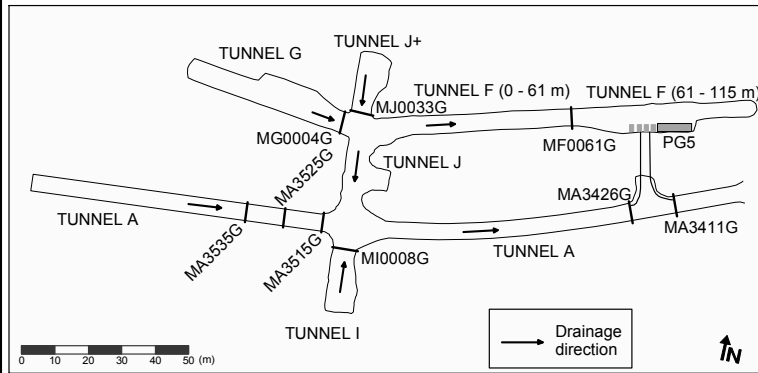
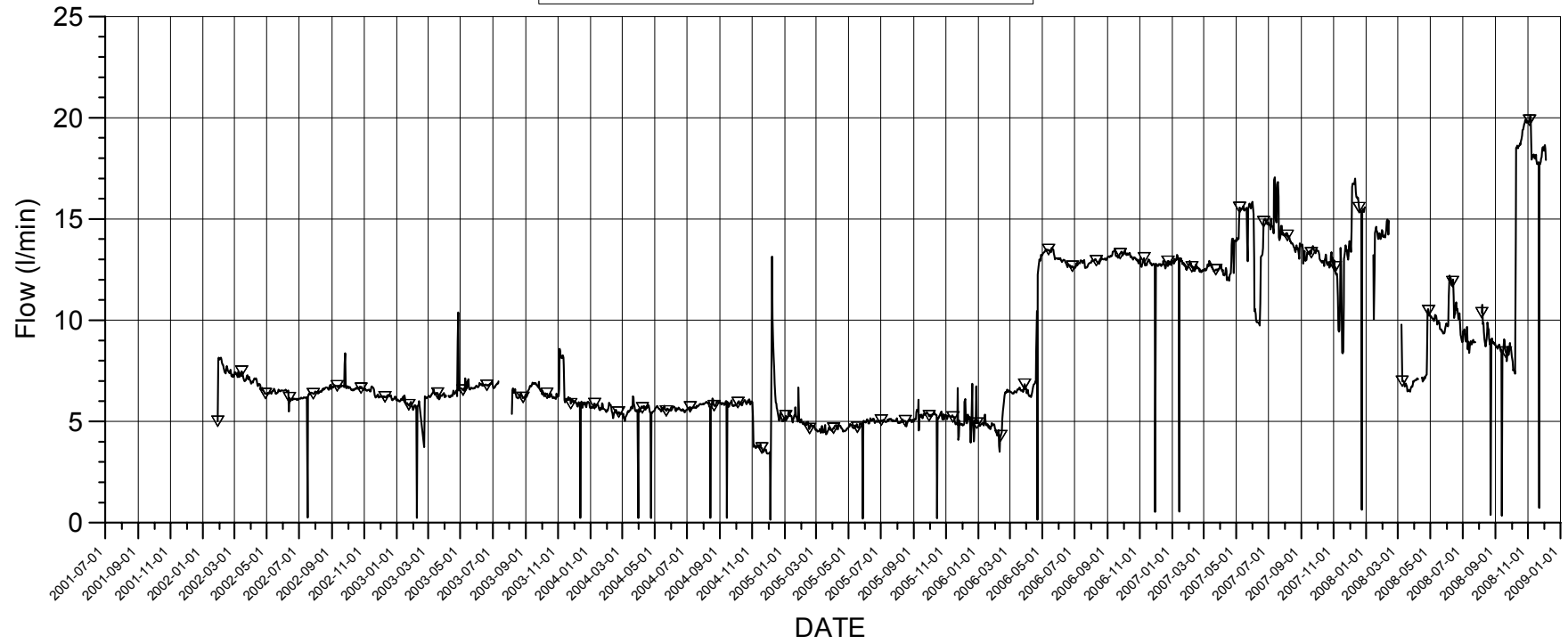

Events

- Start backfilling of section I 2001-09-03
- Stop backfilling of section I 2001-11-20
- Casting of inner plug finalized 2001-12-19
- Start backfilling of section II 2003-04-29
- Stop backfilling of section II 2003-06-27
- Casting of outer plug finalized 2003-09-11
- Start drilling of Fine Sealing Project 2007-03-12
- Start grouting of Fine Sealing Project 2007-11-19

▽ — ▽ WEIR MG0004G

MI0008G WEIR FLOW

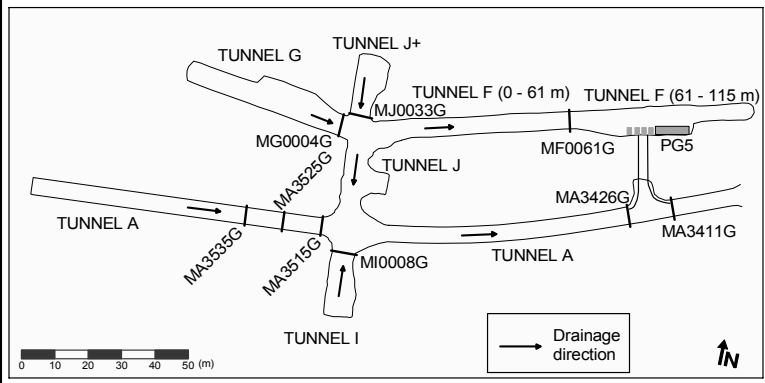
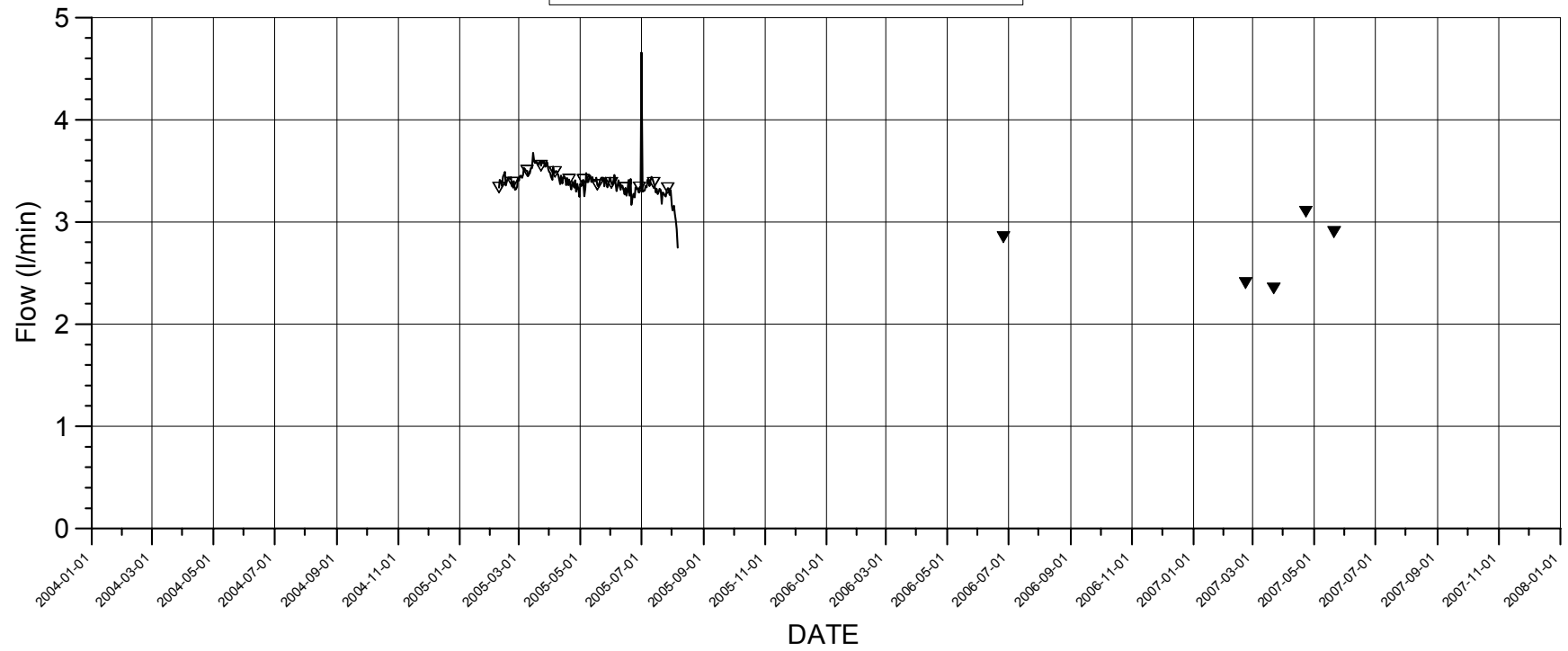

Events

- Start backfilling of section I 2001-09-03
- Stop backfilling of section I 2001-11-20
- Casting of inner plug finalized 2001-12-19
- Start backfilling of section II 2003-04-29
- Stop backfilling of section II 2003-06-27
- Casting of outer plug finalized 2003-09-11

	WEIR MI0008G
	Manual readings

MJ0033G WEIR FLOW

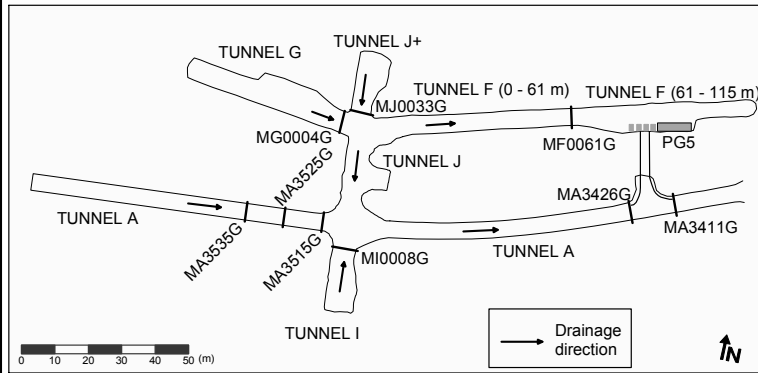
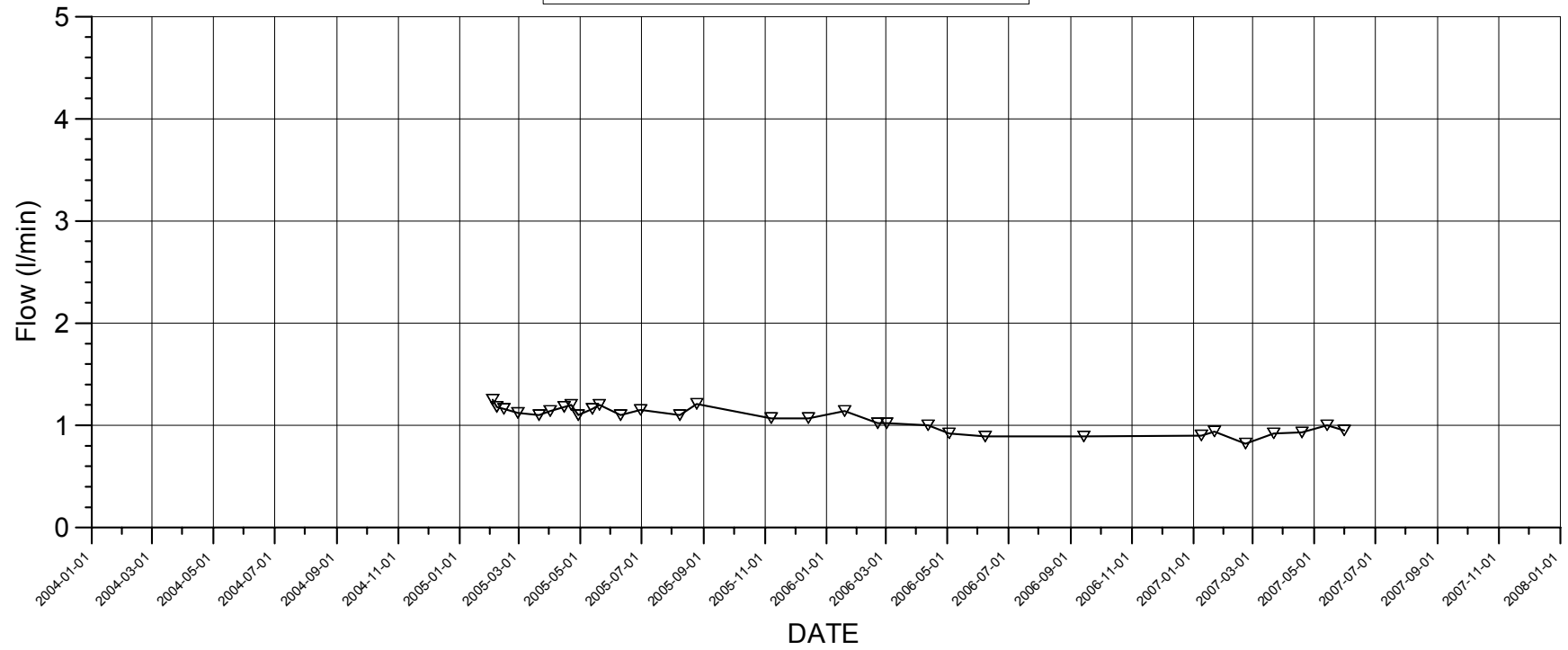

Events

- Start backfilling of section I 2001-09-03
- Stop backfilling of section I 2001-11-20
- Casting of inner plug finalized 2001-12-19
- Start backfilling of section II 2003-04-29
- Stop backfilling of section II 2003-06-27
- Casting of outer plug finalized 2003-09-11

▽ — ▽ WEIR MJ0033G

Quick guide

Transducers in the backfill

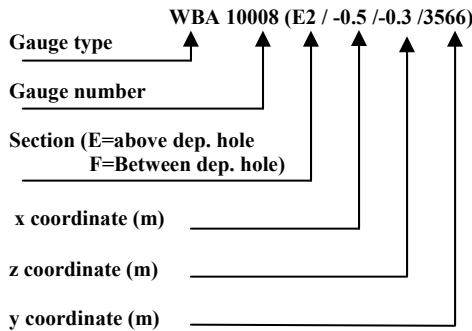

Coordinate system in backfill

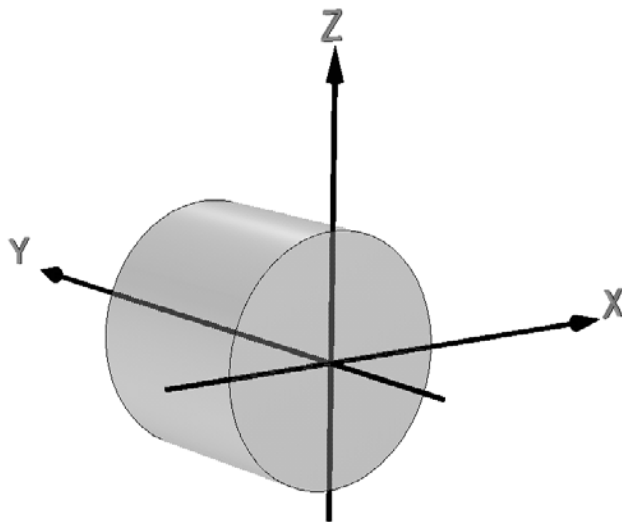

End of tunnel at $Y = 3599.8$ m
 Center dep.hole 1.at $Y = 3587$ m
 Center dep.hole 2 at $Y = 3581$ m
 Center dep.hole 3 at $Y = 3575$ m
 Center dep.hole 4 at $Y = 3569$ m
 Inner plug surface at $Y = 3561.4$ m
 Center dep.hole 5 at $Y = 3551$ m
 Center dep.hole 6 at $Y = 3545$ m
 Outer plug surface at $Y = 3538.6$ m
 Tunnel radius $Z=X = 2.5$ m

Transducers in dep. holes 1, 3,5 and 6 and in the rock

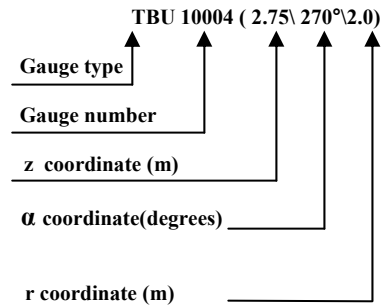

Coordinate system in dep. holes

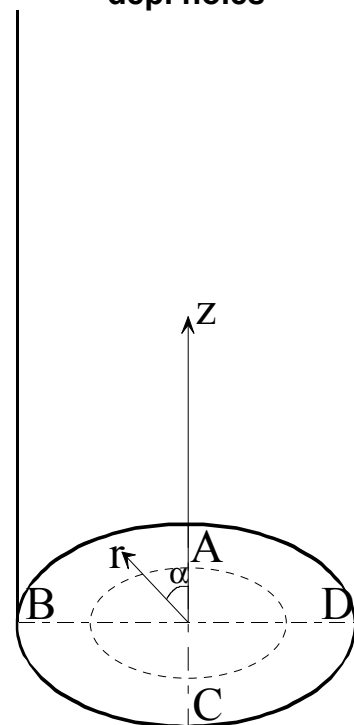

Tunnel direction $C-A$
 Bottom of hole $Z=0$
 Bottom of canister $Z=0.5$
 Top of canister $Z=5.400$
 Upper buffer surface $Z=7.125$
 Dep. hole radius $r=0.875$
 Canister radius $r=0.525$

