

Site investigation SFR

BIPS-logging in the core drilled boreholes KFR102A, KFR102B, KFR103, KFR104 and KFR27 (140–500 m) and radar logging in KFR27 (0–500 m), KFR102A and KFR104

Jaana Gustafsson, Christer Gustafsson
Malå Geoscience AB

February 2009

Svensk Kärnbränslehantering AB
Swedish Nuclear Fuel
and Waste Management Co
Box 250, SE-101 24 Stockholm
Phone +46 8 459 84 00



Site investigation SFR

BIPS-logging in the core drilled boreholes KFR102A, KFR102B, KFR103, KFR104 and KFR27 (140–500 m) and radar logging in KFR27 (0–500 m), KFR102A and KFR104

Jaana Gustafsson, Christer Gustafsson
Malå Geoscience AB

February 2009

Keywords: P-report SKBDoc id 1201715, Review statement SKBDoc id 1201687, BIPS, RAMAC, Radar, TV, Forsmark, AP SFR-08-017, Project SFR extension.

This report concerns a study which was conducted for SKB. The conclusions and viewpoints presented in the report are those of the authors and do not necessarily coincide with those of the client.

Data in SKB's database can be changed for different reasons. Minor changes in SKB's database will not necessarily result in a revised report. Data revisions may also be presented as supplements, available at www.skb.se.

A pdf version of this document can be downloaded from www.skb.se.

Abstract

This report includes the data gained in logging operations performed within the site investigation at SFR. The logging operations presented here includes BIPS loggings in the core-drilled boreholes KFR102A, KFR102B, KFR103, KFR104 and KFR27 (140–500 m) and radar (RAMAC) logging in the core-drilled boreholes KFR27 (0–500) KFR102A and KFR104. All measurements were conducted by Malå Geoscience AB during September–November 2008 and January 2009.

The objective of the radar surveys is to achieve information on the rock mass around the borehole. Borehole radar is used to investigate the nature and the structure of the rock mass enclosing the boreholes.

The objective of the BIPS logging is to achieve information of the borehole including occurrence of rock types as well as determination of fracture distribution and orientation.

This report describes the equipment used as well as the measurement procedures and data gained. For the BIPS surveys, the results are presented as images. Radar data is presented in radargrams and the identified reflectors are listed.

The borehole radar data quality from KFR102A and KFR104 was satisfying to good, but in some parts of lower quality due to high electric conductivity of the borehole fluid. This conductive environment reduces the possibility to distinguish and interpret possible structures in the rock mass which otherwise could give a reflection. The borehole radar measurements in KFR102A resulted in 17 identified radar reflectors of which 11 were orientated (dip/strike), in KFR104 in 11 reflectors of which 8 was orientated and in KFR27 in 15 reflectors of which 11 was orientated.

The BIPS images show relatively good quality along all the logged boreholes. Only in the bottom parts of the boreholes an increased amount of mud limits the visibility.

Sammanfattning

Denna rapport omfattar loggningar inom projekt SFR-Utbyggnad. Mätningarna som presenteras här omfattar BIPS-loggning i kärnborrhålen KFR102A, KFR102B, KFR103, KFR104 samt KFR27 (140–500 m) och borrhålsradarmätningar (RAMAC) i kärnborrhålen KFR27 (0–500), KFR102A och KFR104. Alla mätningar är utförda av Malå Geoscience AB under september till november 2008 samt januari 2009.

Syftet med radarmätningarna är att samla information om bergmassan runt borrhålet. Borrhålsradar används till att karakterisera bergets egenskaper och strukturer i bergmassan närmast borrhålet.

Syftet med BIPS loggningen är att skaffa information om borrhålet inkluderande förekommande bergarter och bestämning av sprickors fördelning och deras orientering.

Rapporten beskriver utrustningen som använts liksom mätprocedurer och en beskrivning och tolkning av data som erhållits. För BIPS loggningarna presenteras data i form av plottar längs med borrhålet. Radardata presenteras i radargram, och en lista över tolkade radarreflektorer ges.

Borrhålsradardata från KFR102A och KFR104 var tillfredställande till bra, men tidvis av sämre kvalitet, troligen till stor del beroende på en elektrisk konduktiv miljö. En hög elektrisk konduktivitet minskar möjligheterna att identifiera strukturer från borrhålsradardata. 17 radarreflektorer har identifierats i KFR102A, varav 11 är orienterade (strykning och stupning). I KFR104 identifierades 11 reflektorer varav 8 orienterade och i KFR27 identifierades 15 reflektorer varav 11 var orienterade (strykning och stupning).

BIPS bilderna är av acceptabel kvalitet. Det är främst längst ner i borrhålen som borrhålsväggen täcker borrhålsväggens nedre del och därmed försämrar bildkvaliteten.

Contents

1	Introduction	7
2	Objective and scope	9
3	Equipment	11
3.1	Radar measurements RAMAC	11
3.2	TV-Camera, BIPS	11
4	Execution	13
4.1	General	13
4.1.1	RAMAC Radar	13
4.1.2	BIPS	15
4.1.3	Length measurements	17
4.2	Analyses and Interpretation	17
4.2.1	Radar	17
4.2.2	BIPS	19
4.3	Nonconformities	19
5	Results	21
5.1	RAMAC logging	21
5.2	BIPS logging	26
	References	29
Appendix 1	Radar logging in KFR27. 0 to 490 m. Dipole antenna 20 MHz	31
Appendix 2	Radar logging in KFR102A. 70 to 584 m. Dipole antenna 20 MHz	33
Appendix 3	Radar logging in KFR104. 6 to 445 m. Dipole antenna 20 MHz	35
	Appendices attached on CD	
Appendix 4	BIPS logging in KFR102A. 71 to 597 m	
Appendix 5	BIPS logging in KFR102B. 13 to 179 m	
Appendix 6	BIPS logging in KFR103. 13 to 199 m	
Appendix 7	BIPS logging in KFR104. 8 to 440 m	
Appendix 8	BIPS logging in KFR27. 140 to 500 m	
Appendix 9	BIPS logging in KFR102A. Repeat section 100 to 120 m	
Appendix 10	BIPS logging in KFR102B. Repeat section 100 to 111 m	
Appendix 11	BIPS logging in KFR103. Repeat section 50 to 60 m	
Appendix 12	BIPS logging in KFR104. Repeat section 200 to 220 m	
Appendix 13	BIPS logging in KFR27. Repeat section 201 to 220 m	

1 Introduction

This document reports the results gained by the geophysical logging operations, which is one of the activities performed within the site investigation at SFR. The work was carried out in accordance with activity plan AP SFR-08-017. In Table 1-1 controlling documents for performing this activity are listed. Both activity plan and method descriptions are SKB's internal controlling documents.

This report includes measurements in the boreholes listed in Table 1-2.

All measurements were conducted by Malå Geoscience AB during September to November 2008 and January 2009. Figure 1-1 shows the location of the boreholes.

The used investigation techniques comprised:

- Borehole radar measurements (Malå Geoscience AB:s RAMAC system) with dipole and directional antennas.
- Borehole TV logging with the Borehole Image Processing System (BIPS) which is a high resolution, side viewing, colour borehole TV system.

The delivered raw and processed data have been inserted in the database of SKB (Sicada) and data are traceable by the activity plan number AP SFR-08-017.

Table 1-1. Controlling documents for the performance of the activity.

Activity plan	Number	Version
BIPS-loggning i kärnborrhålen KFR102A, KFR102B, KFR103, KFR104 samt KFR27 (140–500 m) samt radarloggning i KFR102A och KFR104	AP SFR 08-017	1.0
Method descriptions	Number	Version
Metodbeskrivning för TV- loggning med BIPS	SKB MD 222.006	1.0
Metodbeskrivning för borrhålsradar	SKB MD 252.020	3.0

Table 1-2. Geometrical data for the boreholes.

Borrhole parameter	KFR102A	KFR102B	KFR103	KFR104	KFR27
Coordinates (RT 90)	6701730.30 1633330.21	6701740.53 1633343.91	6701737.13 1633347.20	6701719.45 1632879.34	6701714.42 1633175.52
Direction at TOC	302.3°	344.9°	179.9°	133.8°	248.2°
Dip at TOC	-65.6°	-54.1°	-53.9°	-53.8°	-87.4°
Length	600.83 m	180.08 m	200.5 m	454.57 m	501.64 m
Casing	71.94 m	13.95 m	13.33 m	8.73 m	11.91 m
Borehole diameter (below casing)	75.8 mm	75.8 mm	75.8 mm	75.8 mm	76.8 mm (below casing) 75.8 mm (bottom)

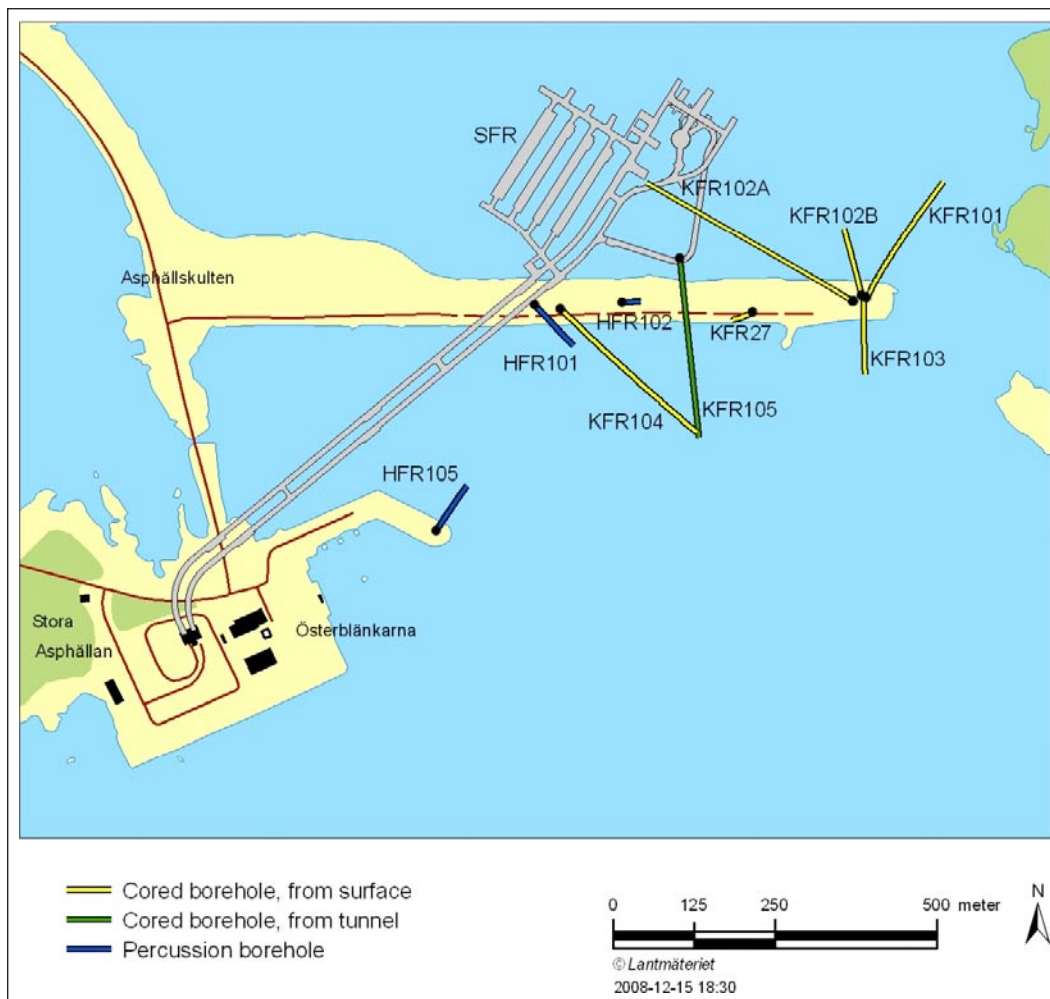

Figure 1-1. Overview over the SFR investigation area, showing the location of the boreholes KFR102A, KFR102B, KFR103, KFR104 and KFR27 surveyed and presented in this report.

2 Objective and scope

The objective of the radar and BIPS surveys is to achieve information on the borehole conditions (borehole wall) as well as on the rock mass around the borehole. Borehole radar is engaged to investigate the nature and the structure of the rock mass enclosing the boreholes, and borehole TV for geological surveying of the borehole including determination of fracture distribution and orientation.

This report describes the equipment used as well as the measurement procedures and data gained. For the BIPS surveys, the results are presented as images. Radar data are presented in radargrams and the identified reflectors are listed.

3 Equipment

3.1 Radar measurements RAMAC

The RAMAC GPR system owned by SKB is a fully digital GPR system where emphasis has been laid on fast survey speed and easy field operation. The system operates dipole and directional antennas (see Figure 3-1). A system description is given in the SKB internal controlling document MD 252.021.

The borehole radar system consists of a transmitter and a receiver antenna. During operation an electromagnetic pulse, within the frequency range of 20 MHz up to 250 MHz, is emitted into the bedrock. Structural features, e.g. a water-filled fractures with sufficiently different electrical properties, causes reflected pulses which are recorded by the receiver.

3.2 TV-Camera, BIPS

The BIPS 1500 system used is owned by SKB and described in SKB internal controlling document MD 222.005. The BIPS method for borehole logging produces a digital scan of the borehole wall. In principle, a standard CCD video camera is installed in the probe in front of a conical mirror (see Figure 3-2). An acrylic window covers the mirror part and the borehole image is reflected through the window and displayed on the cone, from where it is recorded. During the measuring operation, pixel circles are grabbed with a resolution of one pixel per degree.

The system orientates the BIPS images according to two alternative methods, either using a compass (in near-vertical boreholes) or with a gravity sensor (in inclined boreholes).

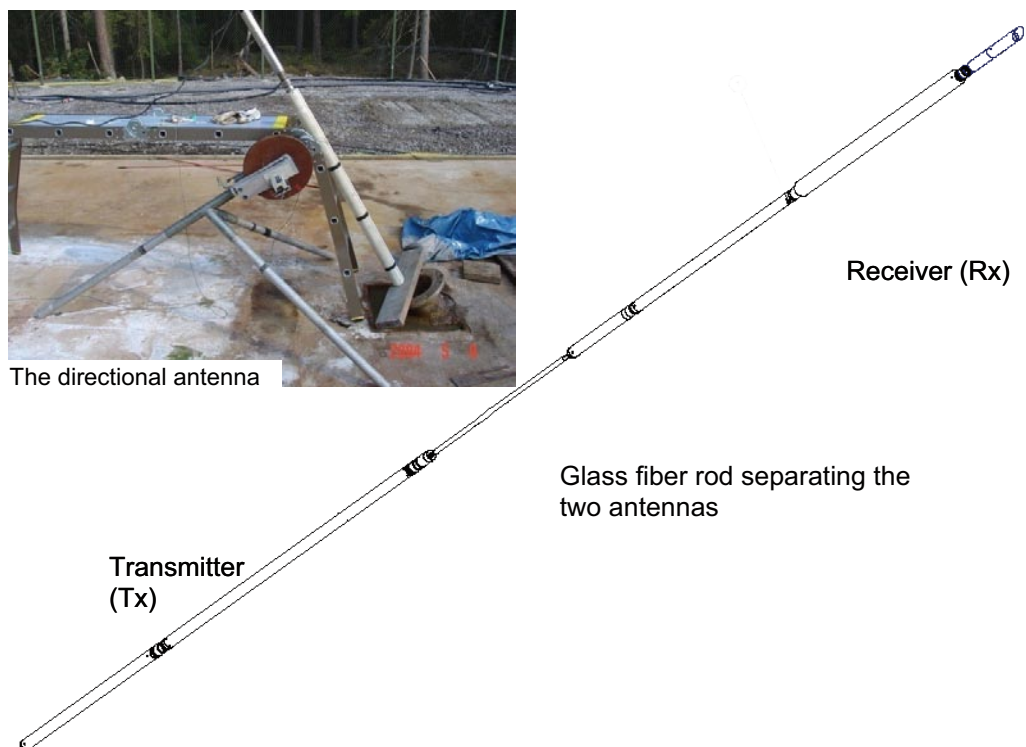

Figure 3-1. Example of a borehole radar antenna.

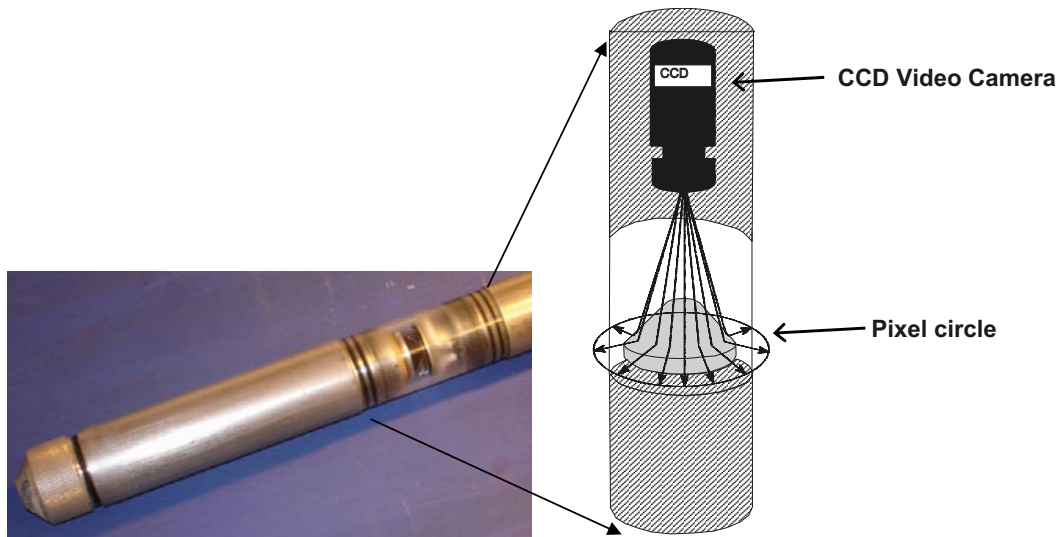

Figure 3-2. The BIP-system. To the right a sketch showing the principles of the conical mirror.

4 Execution

4.1 General

4.1.1 RAMAC Radar

The measurements in KFR27, KFR102A and KFR104 were carried out with a dipole radar antenna with a frequency of 20 MHz and a directional antenna, with a central frequency of 60 MHz.

During logging the dipole antenna (transmitter and receiver) were lowered continuously into the borehole and data were recorded on a field computer along the measured interval. The measurement with the directional antenna is made step wise, with a short pause for each measurement occasion. The antennas (transmitter and receiver, both for dipole and directional) are kept at a fixed separation by glass fiber rods according to Table 4-1. See also Figure 3-1 and 4-1.

All measurements were performed in accordance with the instructions and guidelines from SKB (internal document MD 252.020). Before the logging operation, the antennas and cable were cleaned according to the internal document SKB MD 600.004.

The functionality of the directional antenna was tested before measurements in KFR27, KFR102A and KFR104. This was performed by measurements in the air, where the receiver antenna and the transmitter antenna were placed several meters apart. While transmitting, the receiver antenna was rotated, and the direction from the receiver antenna to the transmitter antenna was estimated. The estimate was compared to a measurement by a compass, and the difference in direction was found to be less than 10 degrees. This can be considered to be satisfying, considering the disturbed environment with metallic objects etc at the test site.

For more information on system settings used in the investigation of KFR27, KFR102 and KFR104, see Tables 4-1 to 4-3.

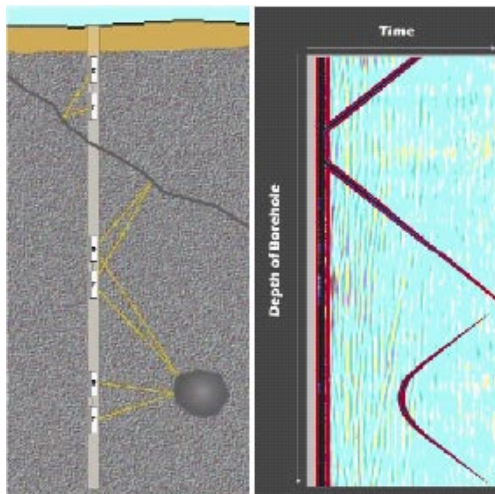

Figure 4-1. The principle of radar borehole reflection survey (left) and an example of result (right).

Table 4-1. Radar logging information from KFR27.

Site:	Forsmark	Logging company:	Malå Geoscience AB
BH:	KFR27	Equipment:	SKB RAMAC
Type:	Directional/Dipole	Manufacturer:	MALÅ Geoscience AB
Operator:	CG	Antenna	
		Directional	20 MHz
Logging date:	2008-11-05	2008-11-05	
Reference:	T.O.C.	T.O.C.	
Sampling frequency (MHz):	615	239	
Number of samples:	512	518	
Number of stacks:	32	Auto	
Signal position:	410.5	-1.42	
Logging from (m):	18.4	6.25	
Logging to (m):	431.4	492.3	
Trace interval (m):	0.5	0.25	
Antenna separation (m):	5.73	10.05	

Table 4-2. Radar logging information from KFR102A.

Site:	Forsmark	Logging company:	Malå Geoscience AB
BH:	KFR102A	Equipment:	SKB RAMAC
Type:	Directional/Dipole	Manufacturer:	MALÅ Geoscience AB
Operator:	CG	Antenna	
		Directional	20 MHz
Logging date:	2009-01-15	2009-01-15	
Reference:	T.O.C.	T.O.C.	
Sampling frequency (MHz):	615	239	
Number of samples:	512	518	
Number of stacks:	32	Auto	
Signal position:	410.5	-1.42	
Logging from (m):	73.4	76.25	
Logging to (m):	587.4	590.65	
Trace interval (m):	0.5	0.25	
Antenna separation (m):	5.73	10.05	

Table 4-3. Radar logging information from KFR104.

Site:	Forsmark	Logging company:	Malå Geoscience AB
BH:	KFR104	Equipment:	SKB RAMAC
Type:	Directional/Dipole	Manufacturer:	MALÅ Geoscience AB
Operator:	CG	Antenna	
		Directional	20 MHz
Logging date:	2008-10-15	2008-10-15	
Reference:	T.O.C.	T.O.C.	
Sampling frequency (MHz):	615	239	
Number of samples:	512	518	
Number of stacks:	32	Auto	
Signal position:	410.5	-1.42	
Logging from (m):	13.4	6.25	
Logging to (m):	442.4	445.3	
Trace interval (m):	0.5	0.25	
Antenna separation (m):	5.73	10.05	

4.1.2 BIPS

All measurements were performed in accordance with the instructions and guidelines from SKB (internal document MD 222.006). All cleaning of the probe and cable was performed according to the internal document SKB MD 600.004 before the logging operation.

During the measurement, a pixel circle with a resolution of 360 pixels/circle was used and the digital circles were stored at every 1 mm on a MO-disc in the surface unit. The maximum speed during data collection was 1.5 m/minute.

A gravity sensor was used to measure the orientation of the images in boreholes KFR102A, KFR102B, KFR103 and KFR104. A magnetic sensor was used in KFR27.

In order to control the image quality of the system, calibration measurements were performed in a test pipe before logging and after logging, see Figures 4-2 to 4-5. The results showed no difference regarding the colours and focus of the images. Results of the test loggings were included in the delivery of the raw data.

The BIPS logging information is found in the header in the presentations in Appendices 4-13.

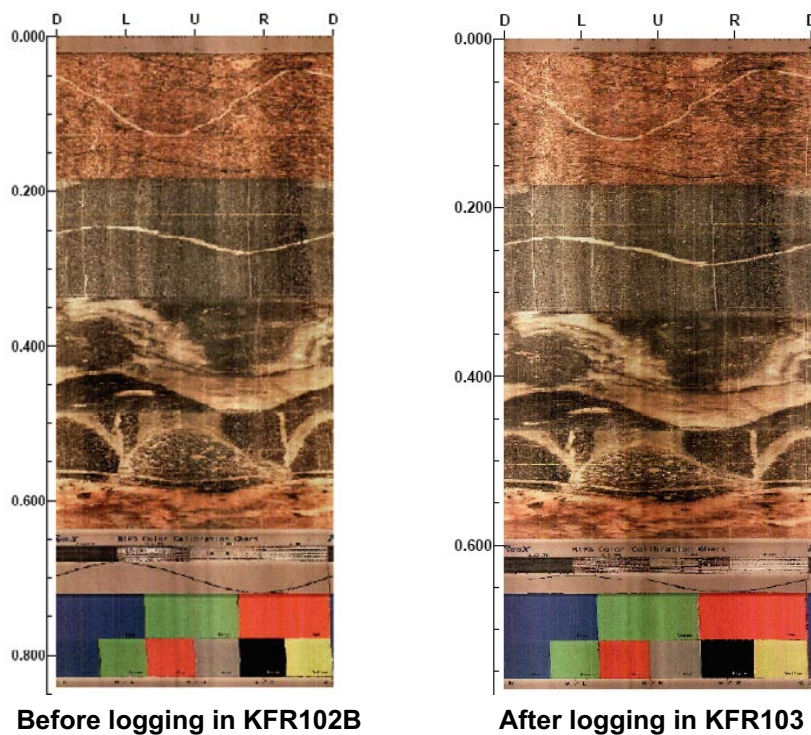

Figure 4-2. Results from logging in the test pipe before and after the logging campaign in September, 2008. The length scales are not essential in the test measurements.

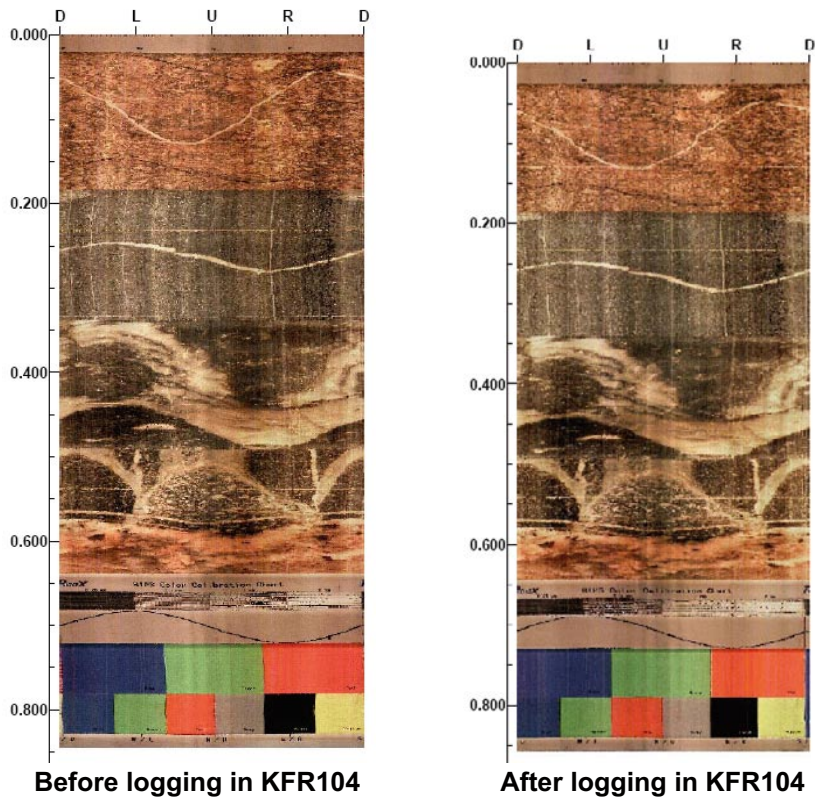

Figure 4-3. Results from logging in the test pipe before and after the logging campaign in October, 2008. The length scales are not essential in the test measurements.

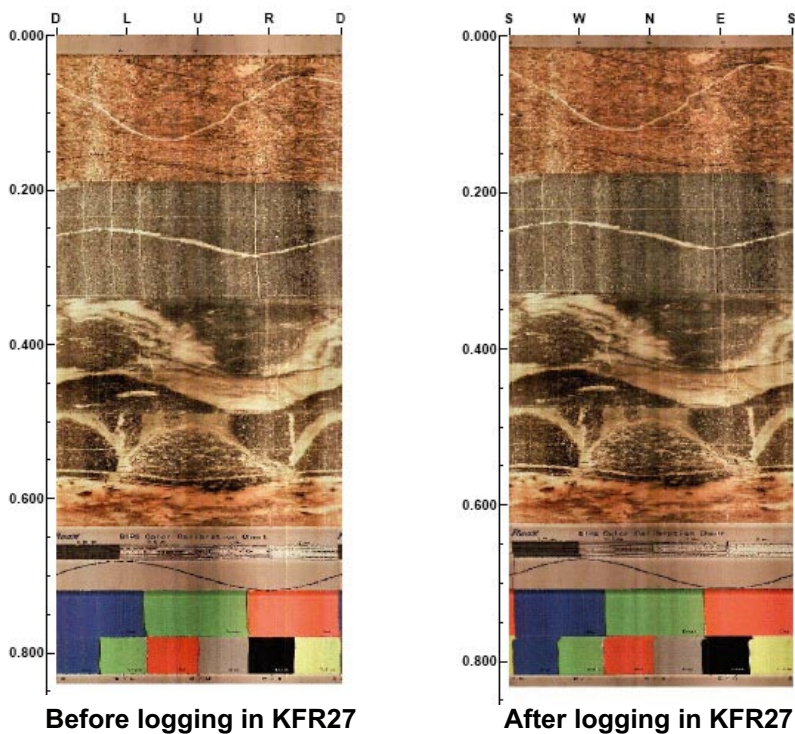

Figure 4-4. Results from logging in the test pipe before and after the logging campaign in November, 2008. The length scales are not essential in the test measurements.

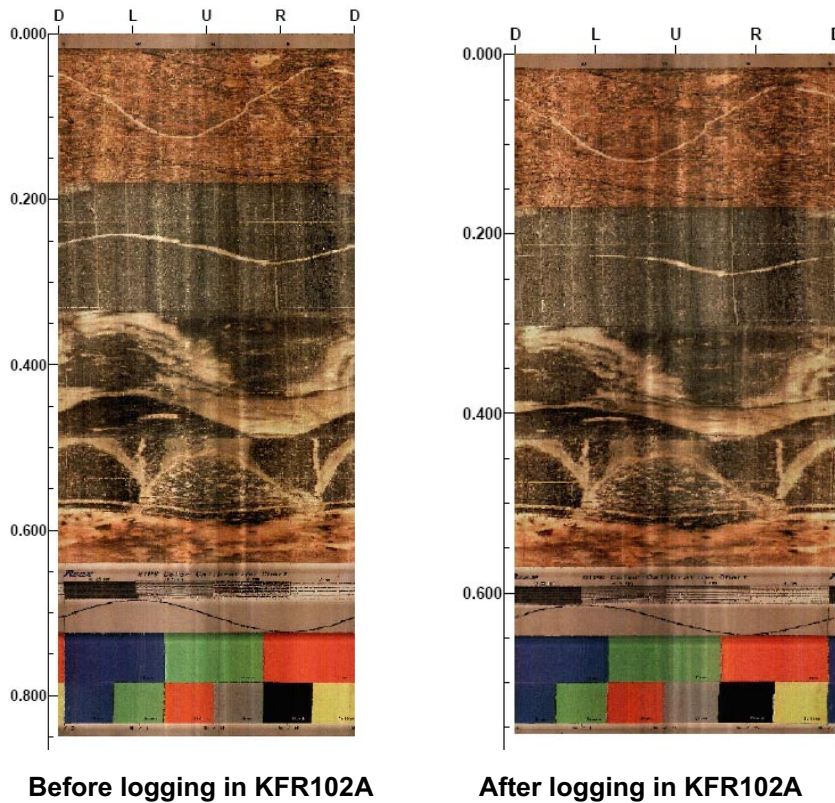

Figure 4-5. Results from logging in the test pipe before and after the logging campaign in January, 2009. The length scales are not essential in the test measurements.

4.1.3 Length measurements

During logging the length recording for the RAMAC systems is taken care of by a measuring wheel mounted on the cable winch. The logging is measured from TOC (Top of Casing). The length is adjusted to the bottom of casing when visible in the BIPS image.

During the BIPS logging in core drilled boreholes, where the reference marks in the borehole wall is visible on the image, the position where the reference mark is visible is marked with scotch tape on the logging cable. During BIPS logging the measured length was adjusted to true length according to reference mark visible in the BIPS image. The adjusted true length is marked with red figures in the image plot together with the non-adjusted measured length. The non-adjusted length is marked with black figures as seen in Appendices 4 to 8. The tape marks on the logging cable are then used for controlling the RAMAC measurement.

The experience we have from earlier measurements with dipole antennas in the core drilled boreholes in Forsmark and Oskarshamn is that the length divergence is less than 100 cm in the deepest parts of a 1,000 meter long borehole. The length divergence is taken into account in the resulting tables in Chapter 5.

4.2 Analyses and Interpretation

4.2.1 Radar

The result from radar measurements is most often presented in the form of a radargram where the position of the probes is shown along one axis and the propagation is shown along the other axis. The amplitude of the received signal is shown in the radargram with a grey scale where black color corresponds to the large positive signals and white color to large negative signals. Grey color corresponds to no reflected signals.

The presented data in this report is adjusted for the measurement point of the antennas. The measurement point is defined to be the central point between the transmitter and the receiver antenna.

The two basic patterns to interpret in borehole measurements are point and plane reflectors. In the reflection mode, borehole radar essentially gives a high-resolution image of the rock mass, showing the geometry of plane structures which may or may not, intersect the borehole (contact between layers, thin marker beds, fractures etc) or showing the presence of local features around the borehole (cavities, lenses etc).

The distance to a reflecting object or plane is determined by measuring the difference in arrival time between the direct and the reflected pulse. The basic assumption is that the speed of propagation is the same everywhere.

There are several ways to determine the radar wave propagation velocity. Each of them has advantages and disadvantages. In this project the velocity determination was performed by keeping the transmitter fixed in the borehole while moving the receiver downwards in the borehole. The result is plotted in Figure 4-6, and the calculation shows a velocity of 128 m/μs (metres per microsecond) /1/. The velocity measurement was performed with the 100 MHz antenna.

The visualization of data in Appendices 1 to 3 is made with ReflexWin, a Windows based processing software for filtering and analysis of borehole radar data. The processing steps for the data presented in Appendices 1 to 3 are given in Table 4-4 to 4-6. The filters applied affect the whole borehole length and are not always suitable in all parts, depending on the geological conditions and conductivity of the borehole fluid. During interpretation further processing can be done, most often in form of bandpass filtering. This filtering can be applied just in parts of the borehole, where needed.

For the interpretation of the intersection angle between the borehole axis and the planes visible on the radargrams the RadinterSKB software has been used. The interpreted intersection points and intersection angles of the detected structures are presented in the Tables 5-1 to 5-3 and are also visible on the radargrams in Appendices 1 to 3.

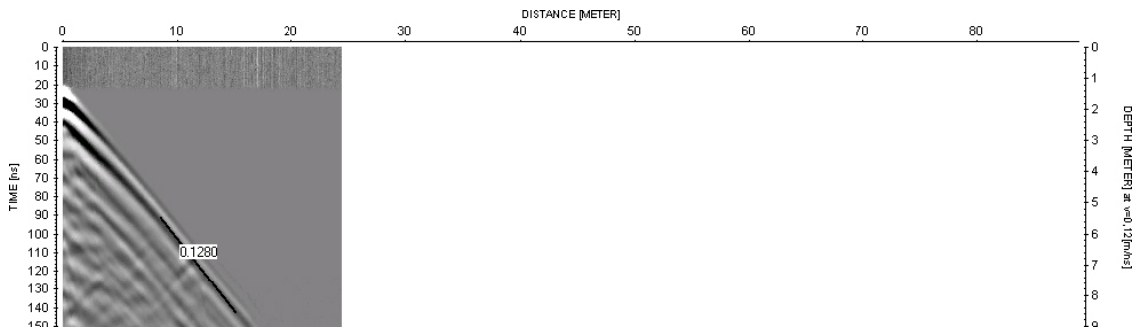

Figure 4-6. Results from velocity measurements in HFM03.

Table 4-4. Processing steps for borehole radar data from KFR27.

Site:	Forsmark	Logging company:	Malå Geoscience AB
BH:	KFR27	Equipment:	SKB RAMAC
Type:	Directional/Dipole	Manufacturer:	MALÅ Geoscience AB
Interpret:	JG	Antenna	
		Directional	20 MHz
Processing steps	Move start time (23 samples)	Move start time (-86)	
	DC shift (414–510)	DC shift (1,600–1,800)	
	Time gain (start 41 lin 100 exp 1)	Gain (Start 59 lin 5 exp 0.1)	
	(FIR)	(Bandpass)	

Table 4-5. Processing steps for borehole radar data from KFR102A.

Site:	Forsmark	Logging company:	Malå Geoscience AB
BH:	KFR102A	Equipment:	SKB RAMAC
Type:	Directional/Dipole	Manufacturer:	MALÅ Geoscience AB
Interpret:	JG	Antenna	20 MHz
		Directional	
Processing steps		Move start time (33 samples)	Move start time (-80)
		DC shift (400–510)	DC shift (1,600–1,800)
		Time gain (start 60 lin 100 exp 5)	Gain (Start 65 lin 5.2 exp 0.1)
		(FIR)	(Bandpass)

Table 4-6. Processing steps for borehole radar data from KFR104.

Site:	Forsmark	Logging company:	Malå Geoscience AB
BH:	KFR104	Equipment:	SKB RAMAC
Type:	Directional/Dipole	Manufacturer:	MALÅ Geoscience AB
Interpret:	JG	Antenna	20 MHz
		Directional	
Processing steps		Move start time (23 samples)	Move start time (-116)
		DC shift (409–510)	DC shift (1,600–1,800)
		Time gain (start 62 lin 100 exp 1)	Gain (Start 109 lin 4.3 exp 0.2)
		(FIR)	Bandpass

4.2.2 BIPS

The visualization of data is made with BDPP, a Windows based processing software for filtering, presentation and analysis of BIPS data. As no fracture mapping of the BIPS image is performed, the raw data was delivered on a CD-ROM together with printable pictures in *.pdf format before the field crew left the investigation site.

The printed results were delivered with measured length, together with adjusted length according to the length marks made on the cable when logging core-drilled boreholes (where the length marks are visible in the BIPS image). For printing of the BIPS images the printing software PDPP from RaaX was used.

4.3 Nonconformities

No nonconformities occurred during the logging of the boreholes included in this report.

5 Results

The results from the BIPS measurements in KFR102A, KFR102B, KFR103, KFR104 and KFR27 (140–500 m) were delivered as raw data (*.bip-files) together with printable BIPS pictures in *.pdf format before the field crew left the investigation site. The information of the measurements was registered in Sicada, and the CD-ROM:s stored by SKB.

The RAMAC radar data for KFR27 (0–500 m), KFR102A and KFR104 was delivered as raw data (file format *.rd3 or *.rd5) with corresponding information files (file format *.rad) on CD-ROM:s to SKB before the field crew left the investigation site, whereas the data processing steps and results are presented in this report. Relevant information, including the interpretation presented in this report, was inserted into the SKB database Sicada.

5.1 RAMAC logging

The results of the interpretation of the radar measurements are presented in Tables 5-1 to 5-3. Radar data are also visualized in Appendices 1 to 3. It should be remembered that the images in Appendices 1 to 3 is a composite picture of all events 360 degrees around the borehole, and do not reflect the orientation of the structures.

Only the larger clearly visible structures are interpreted in RadinterSKB. An overview of the boreholes is given in Figure 5-1 below. Differences in data quality can be observed along both of the borehole. In KFR27 the depth penetration is not that good in the upper part of the borehole as in the mid-parts, and again in the low parts a very affected zone is seen. In KFR102A an area can be observed with a clearly affected depth penetration, around 450 m. Also observe the sub-parallel structure (0 to 500 ns from the borehole) which is visible almost along the whole borehole length. At a depth of 380 m a part is orientated. In KFR104 the depth penetration is decreased in the upper part of the borehole and in the lowermost part a very clear structure can be identified.

A number of minor structures also exist, as indicated in Appendices 1 to 3. Often clusters of structures can be noticed, but often located so close to each other that it is impossible to distinguish one from the other. Larger structures parallel to the borehole, if present, are also indicated in Appendices 1 to 3. It should also be pointed out that an interpreted reflector always results in an intersection with the borehole (unless the reflector is strictly parallel to the hole). However, sometimes this intersection point is localized outside the range of the borehole.

The data quality from KFR27, KRF102A and KFR104 (as seen in Appendices 1 to 3) is satisfying to good, but in some parts of lower quality due to more conductive conditions. An electrical conductive environment causes an attenuation of the radar wave, which in turn decreases the penetration. This conductive environment of course also reduces the possibility to distinguish and interpret possible structures in the rock which otherwise could give a reflection.

This effect is also seen in the directional antenna, which makes it more difficult to interpret the direction to the identified structures.

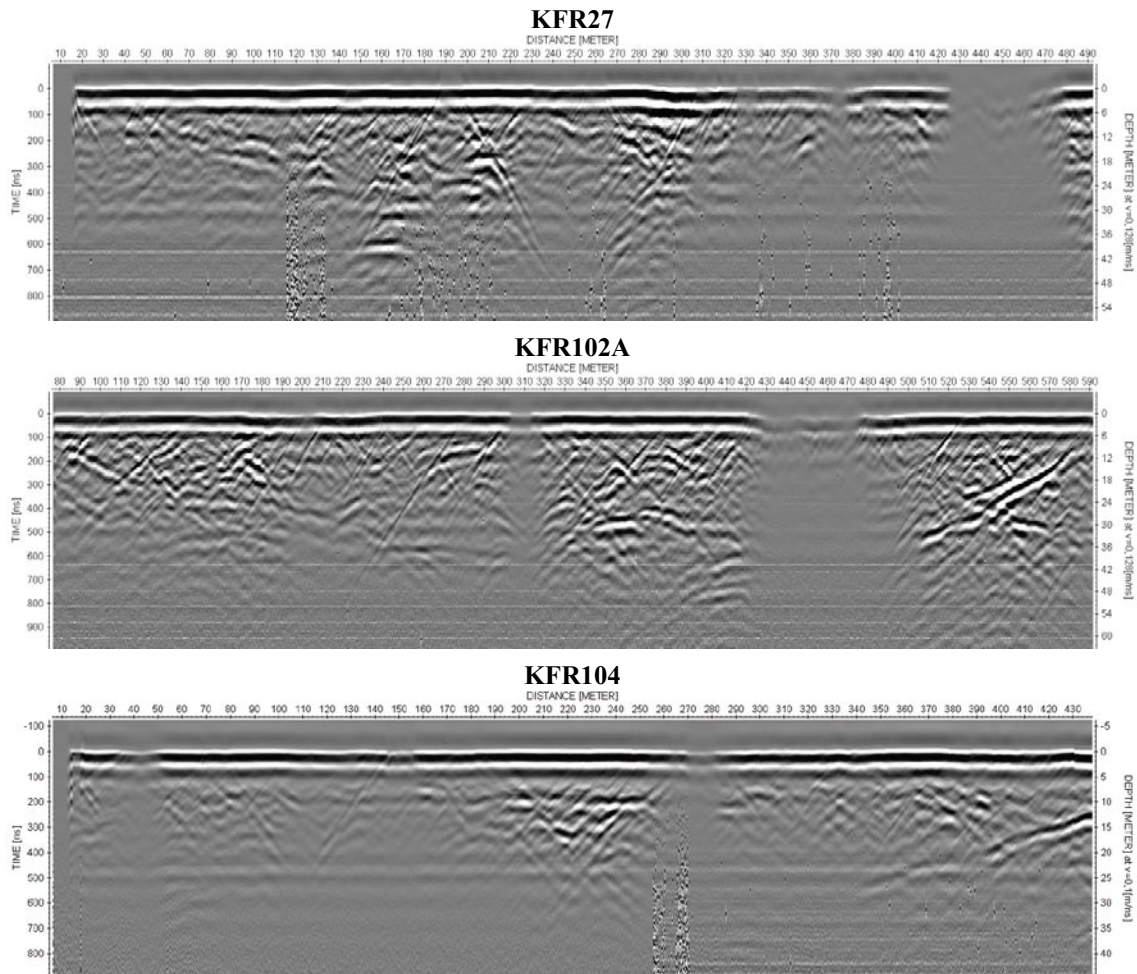

Figure 5-1. An overview (20 MHz data) of the radar data for the boreholes KFR27 (0–500 m), KFR102A and KFR104. Observe that in both boreholes KFR102A and KFR104 a clear sub-parallel structure is visible at the end part of the borehole.

Tables 5-1 to 5-3 summarises the interpretation of radar data from KFR27, KFR102A and KFR104. In the table the borehole length and intersection angle to the identified structures are listed.

As seen, some radar reflectors in Tables 5-1 to 5-3 are marked with \pm , which indicates an uncertainty in the interpretation of direction. The direction can in these cases be ± 180 degrees. The direction to the object (the plane) is defined in Figure 5-2 and Figure 5-3. This direction and the intersection angle are recalculated to strike and dip, also given in the tables below. The plane strike is the angle between the line of the plane’s intersection with the surface and the Magnetic North direction. A strike of 0 degrees implies a dip to the east while a strike of 180 degrees implies a dip to the west (right-hand rule). The strike is measured clockwise and can vary from 0 to 359 degrees. The dip of the plane is the angle between the ground surface and the plane, and can vary from 0 to 90 degrees.

Observe that the interpretation of an undulating structure can result in several different angles and different intersection lengths. An example of this phenomenon is seen in for example Table 5-2 and Appendix 2: the reflectors named 11, 11x and 11xx most likely originate from the same geological structure.

Table 5-1. Interpretation of radar reflectors from the dipole antenna 20 MHz and directional antenna 60 MHz in borehole KFR27 (0–500 m).

RADINTER MODEL INFORMATION (Directional and dipole antennas)							
Site: Forsmark							
Borehole name: KFR27							
Nominal velocity (m/μs): 128.0							
Name	Intersection length	Intersection angle	RadInter direction to object (gravity roll)	Dip 1	Strike 1	Dip 2	Strike 2
6	-227.8	4					
7	55.3	81	288	9	18		
8	68.9	64	318 ±	26	48	26	228
11x	117.7	6					
9	152.2	63	165 ±	27	255	27	75
5	174.0	31	273	55	3		
10	184.2	30	81	60	171		
1x	188.2	82					
11	194.6	14	138	76	228		
1	194.7	75	0	15	90		
2	257.9	56	147	30	237		
3	316.2	80	18 ±	11	108	11	288
12	334.2	85	177 ±	1	352	11	332
13	348.1	32	0 ±	65	334	53	154
4	365.6	47					

Table 5-2. Interpretation of radar reflectors from the dipole antenna 20 MHz and directional antenna 60 MHz in borehole KFR102A.

RADINTER MODEL INFORMATION (Directional and dipole antennas)							
Site: Forsmark							
Borehole name: KFR102A							
Nominal velocity (m/μs): 128.0							
Name	Intersection length	Intersection angle	RadInter direction to object (gravity roll)	Dip 1	Strike 1	Dip 2	Strike 2
1	40.7	18	108	68	131		
2	103.2	63	105 ±	29	87	38	351
3	154.0	30	270 ±	63	315	63	108
4	207.2	65	324	45	12		
5	215.7	74	153 ±	12	71	39	20
6	228.7	65					
7	251.4	61	321	50	9		
8	286.7	58	282	45	342		
9x	301.6	45					
9	311.3	50					
14	325.5	33	0 ±	83	33	32	213
10	534.6	49	273	48	335		
11x	601.7	49					
12	635.7	54					
11	637.2	17	267	74	310		
11xx	769.6	9					
13	Area		285				

Table 5-3. Interpretation of radar reflectors from the dipole antenna 20 MHz and directional antenna 60 MHz in borehole KFR104.

RADINTER MODEL INFORMATION (Directional and dipole antennas)							
Site: Forsmark							
Borehole name: KFR104							
Nominal velocity (m/ μ s): 128.0							
Name	Intersection length	Intersection angle	RadInter direction to object (gravity roll)	Dip 1	Strike 1	Dip 2	Strike 2
11	53.3	37	336	87	195		
1	63.3	60					
10	73.8	72	186 \pm	19	209	54	216
2	86.5	57	207 \pm	16	131	71	231
3	112.2	54	354	71	210		
4	154.4	53	201	15	105		
5	222.5	39					
8	270.7	48					
6	278.2	44	207 \pm	20	109	85	232
7	384.0	61	9 \pm	70	216	11	184
9	555.1	11	201 \pm	42	63	63	55

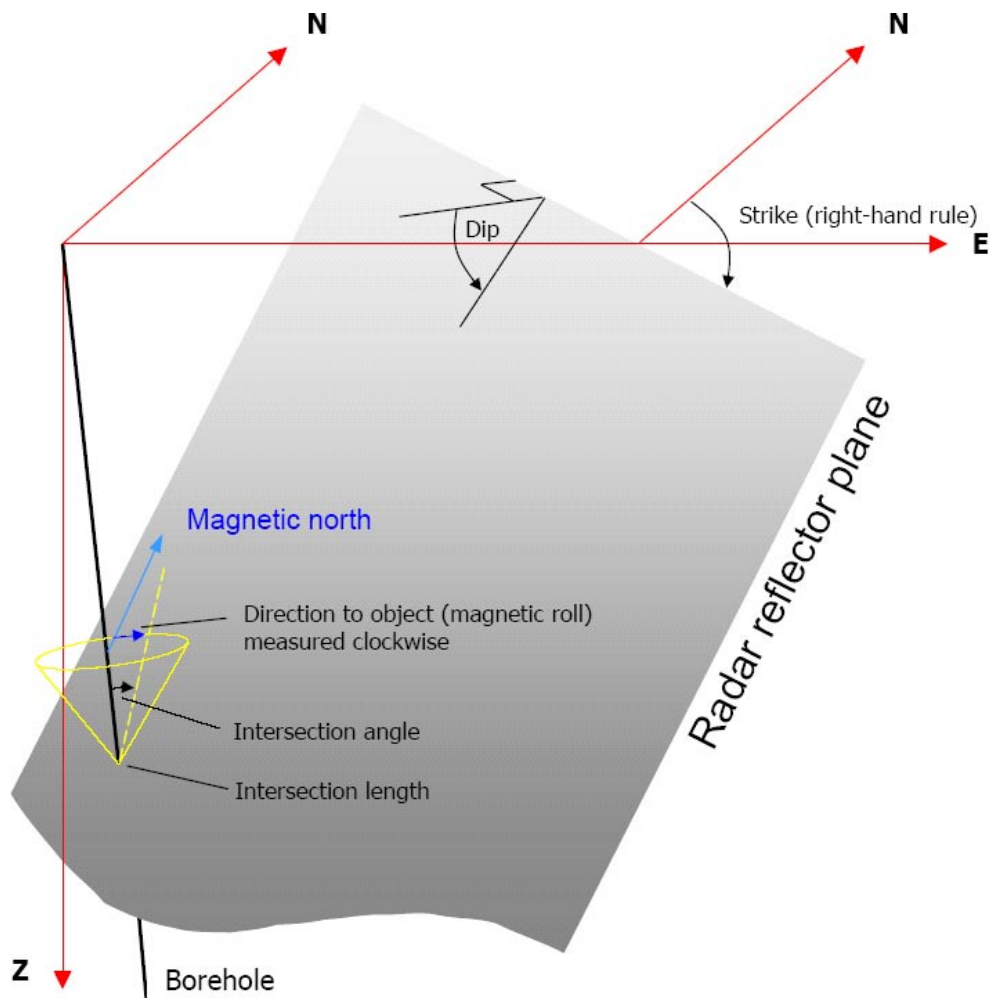

Figure 5-2. Definition of the direction to a reflector (magnetic roll) as presented in Table 5-1.

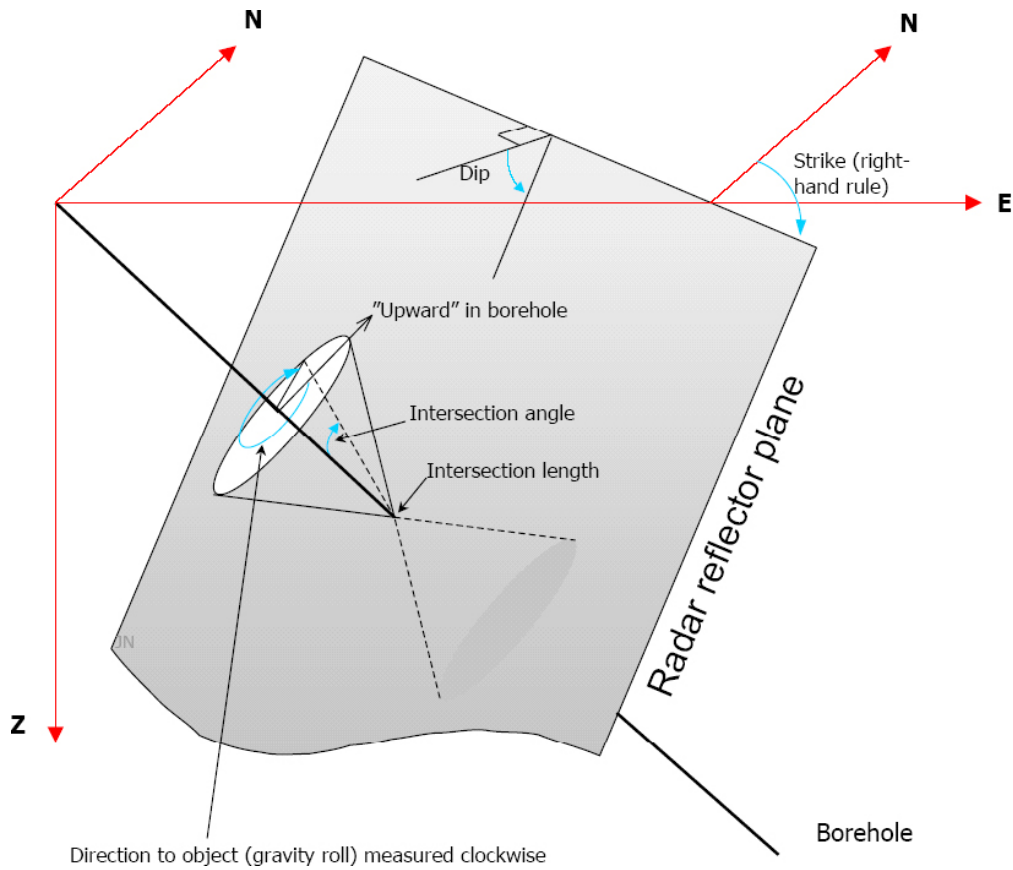

Figure 5-3. Definition of the direction to a reflector (gravity roll) as presented in Tables 5-2 and 5-3.

The structures considered as the most important (clear in the radargram, identified with both antenna frequencies, stretching out far from the borehole wall etc) are listed in Table 5-4 below.

Observe that it can be very difficult to classify different structures in an objective manner along a borehole. This is due to the fact that the water quality (the conductivity) amongst other parameters varies along the borehole length. This variation affects the results of the radar logging, by for instance attenuating the radar waves differently. Also the intersection angle of the identified structures affects the amplitude on the resulting radargram. A small angle will most often cause larger amplitude than a large angle, and by that a more clear structure.

Table 5-4. Some important structures in KFR102A, KFR104 and KFR27.

Borehole	KFR102A	KFR104	KFR27
Structures	1, 5, 8, 9, 10 and 11	4, 6 and 9	1, 1x, 6, 11 and 11x

5.2 BIPS logging

The BIPS pictures are presented in Appendices 4 to 8.

To get the best possible length accuracy, the BIPS images are adjusted to the reference marks on the logging cable. Additionally the reference marks on the borehole wall are visible on the BIPS screen. The recorded length is adjusted to these visible marks.

In order to control the quality of the system, calibration measurements were performed in a test pipe before logging the first borehole and after logging of the last borehole in the campaign. The resulting images displayed no differences regarding the colours and focus of the images. The results of the test loggings were included in the delivery of the field data and are also presented in Figure 4-2 and 4-5 in this report.

Repeat sections (10–20 m long) have been performed in the boreholes in order to check the accuracy of the interpretation of the direction to an object. The repeat sections are presented in Appendices 9 to 13. A few features, visible in both images from the two runs, have been compared. The results are presented in Table 5-5 to Table 5-9 and shows that the accuracy of the orientation of the images is within the expected accuracy of the BIPS system. In KFR27 the tool face was calculated using the compass, and these orientation results indicate a slightly poorer accuracy (maximum difference 4.7 degrees) comparing to the results from the other boreholes in which the gravity sensor was used.

Values for the inclination and azimuth of the boreholes, presented in this report, are only preliminary.

The BIPS images show generally acceptable quality for all logged boreholes. However, in most boreholes mud covers a string along the bottom part of the boreholes. This is particu especially at the very bottom.

Table 5-5. Differences in tool face orientation between the delivered logging and repeat section for borehole KFR102A.

KFR102A (meter)	Delivered Tool face orientation	Repeat section Tool face orientation	Difference between the two runs
100.1	318.6	322.2	-3.6
103.7	236.7	240.4	-3.7
106	239.8	239.9	-0.1
116.1	281.3	282.5	-1.2
119.7	283.8	282.6	1.2

Table 5-6. Differences in tool face orientation between the delivered logging and repeat section for borehole KFR102B.

KFR102B (meter)	Delivered Tool face orientation	Repeat section Tool face orientation	Difference between the two runs
100.1	17.2	16.8	0.4
101.5	260.1	260.3	-0.2
105.6	290.1	289.2	0.9
109.7	285.7	288.7	-3
110.5	138.8	141.9	-3.1

Table 5-7. Differences in tool face orientation between the delivered logging and repeat section for borehole KFR103.

KFR103 (meter)	Delivered Tool face orientation	Repeat section Tool face orientation	Difference between the two runs
50.2	104.8	107.1	-2.3
51.1	220.4	221.8	-1.4
54.7	303.2	302.4	0.8
55.1	233.1	235.5	-2.4
57.3	275.1	277.6	-2.5

Table 5-8. Differences in tool face orientation between the delivered logging and repeat section for borehole KFR104.

KFR104 (meter)	Delivered Tool face orientation	Repeat section Tool face orientation	Difference between the two runs
200.3	219.6	218.1	1.5
204.8	312.1	309.8	2.3
207	321.9	320.5	1.4
213	267.9	268.6	-0.7
214.5	101.7	100.4	1.3

Table 5-9. Differences in tool face orientation between the delivered logging and repeat section for borehole KFR27 (140–500 m).

KFR27 (meter)	Delivered Tool face orientation	Repeat section Tool face orientation	Difference between the two runs
203	179.2	177.2	2
204.5	281.5	280	1.5
206.5	331.9	330.8	1.1
211.4	260	255.3	4.7
218.5	289.8	283.8	6
219.4	259.2	255.3	3.9

References

- /1/ **Gustafsson C, Nilsson P, 2003.** Geophysical Radar and BIPS logging in borehole HFM01, HFM02, HFM03 and the percussion drilled part of KFM01A. SKB P-03-39. Svensk Kärnbränslehantering AB.

Radar logging in KFR27. 0 to 490 m. Dipole antenna 20 MHz

FORSMARK KFR27 20 MHz data

31

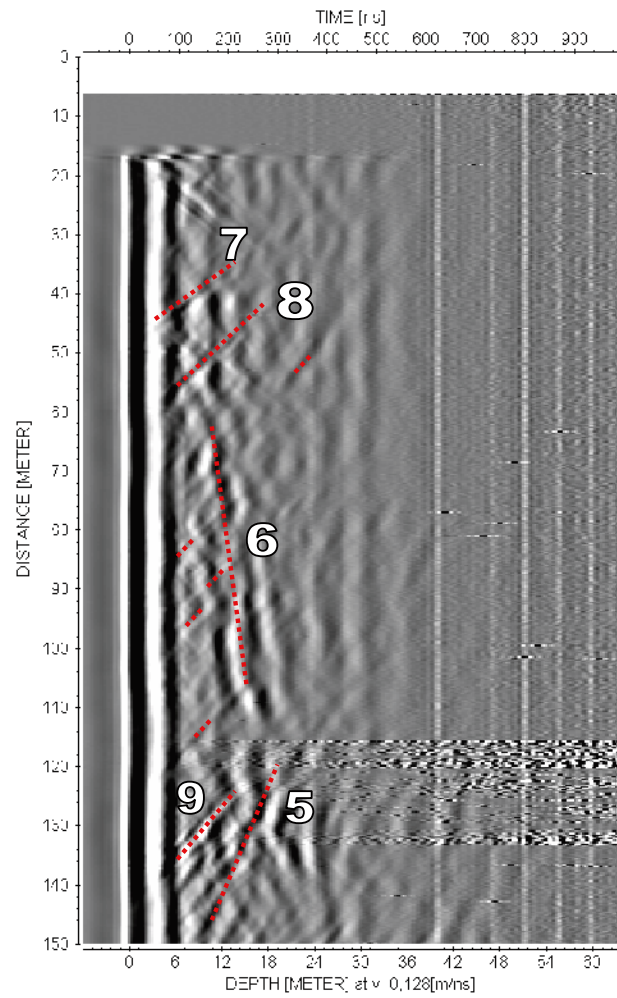

0-150 m

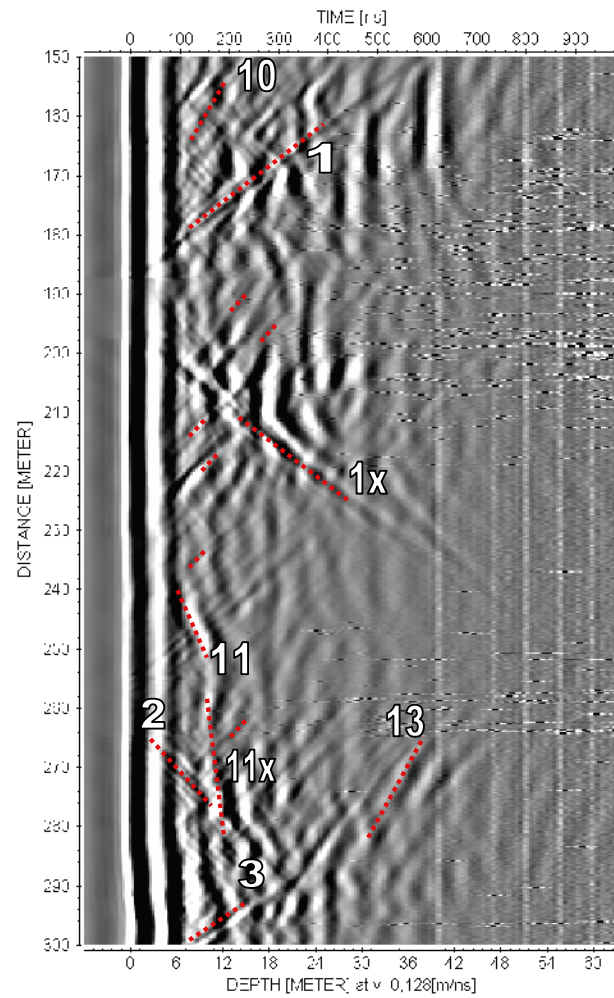

150-300 m

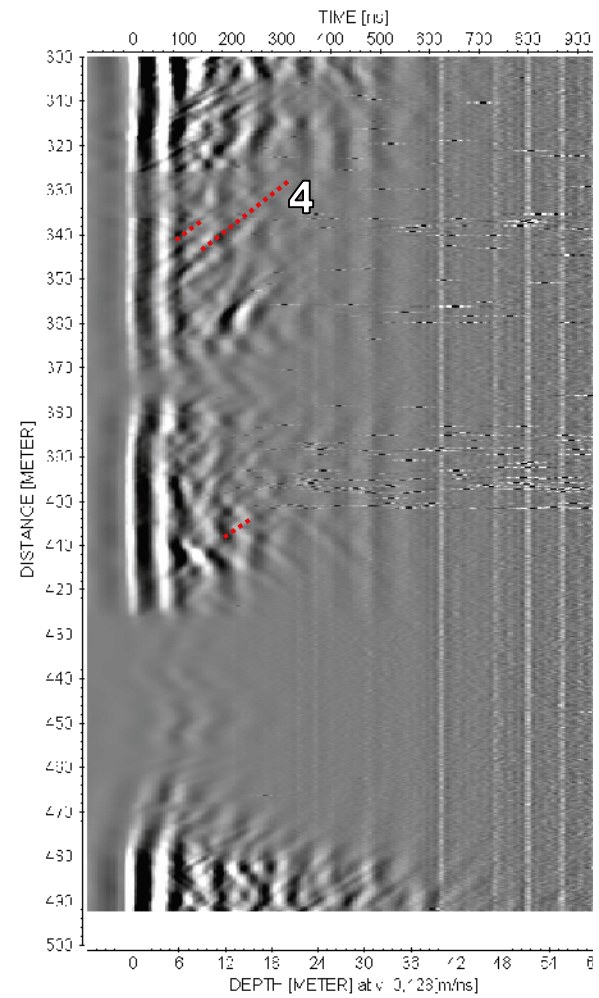

300-500 m

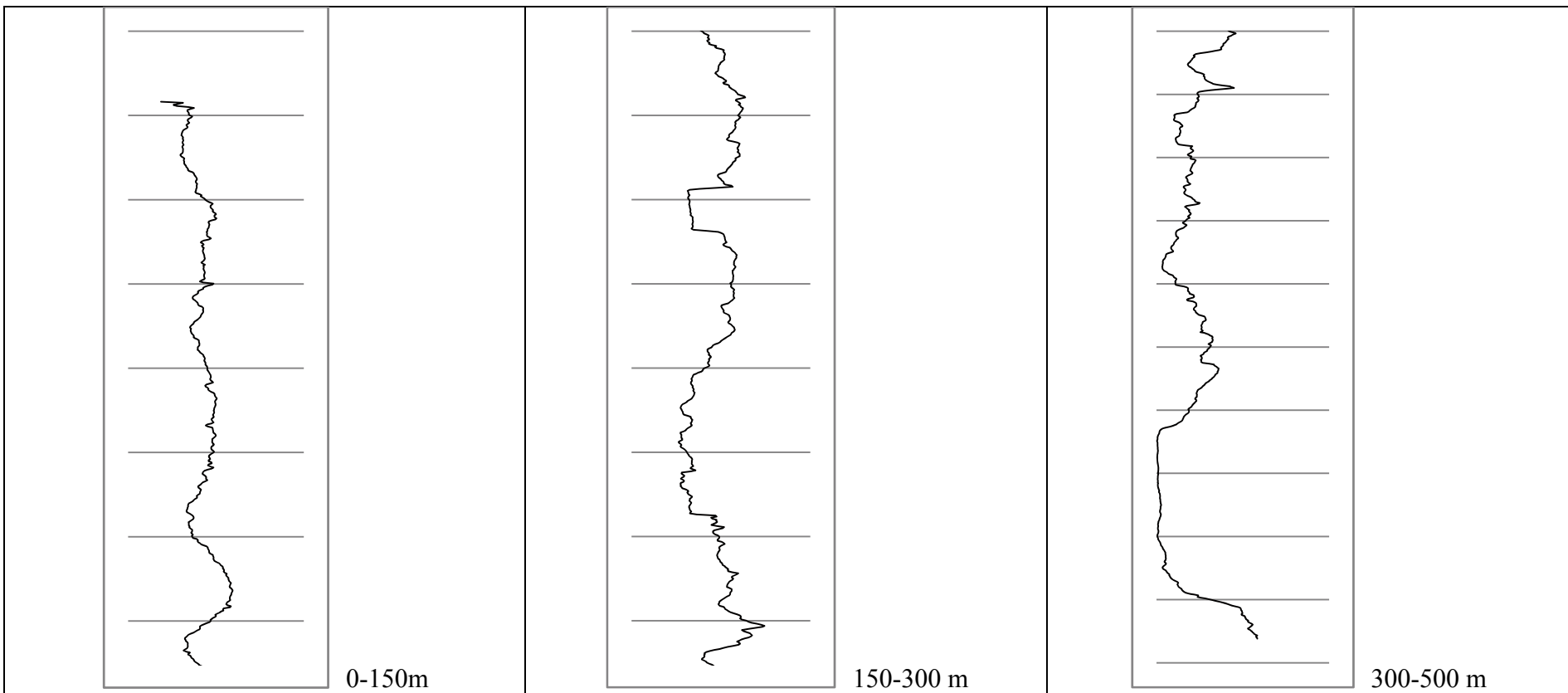

Radar logging in KFR102A. 70 to 584 m. Dipole antenna 20 MHz

FORSMARK KFR102A 20 MHz data

33

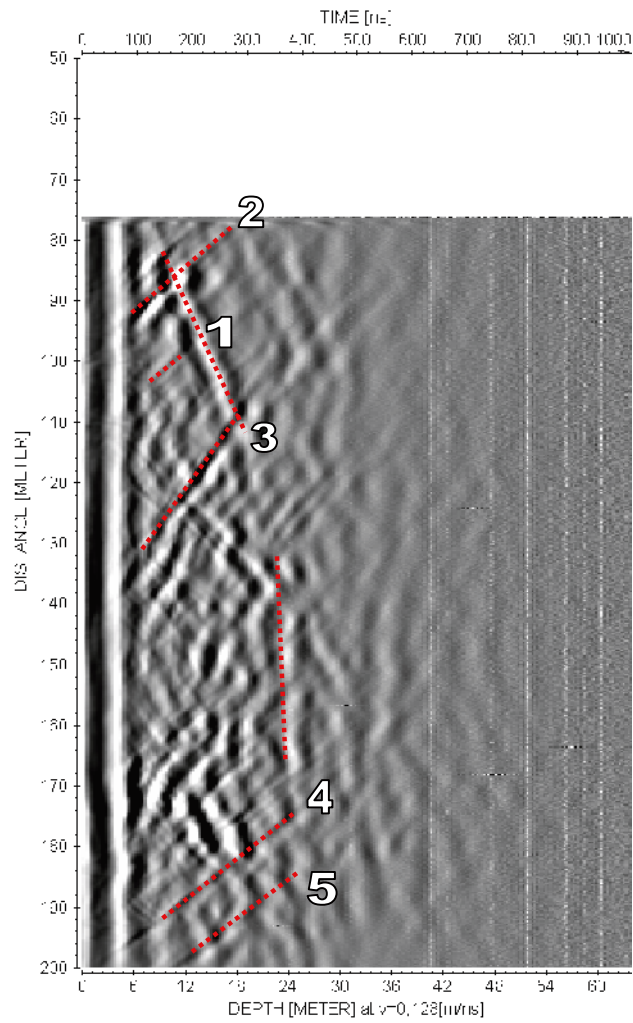

50-200 m

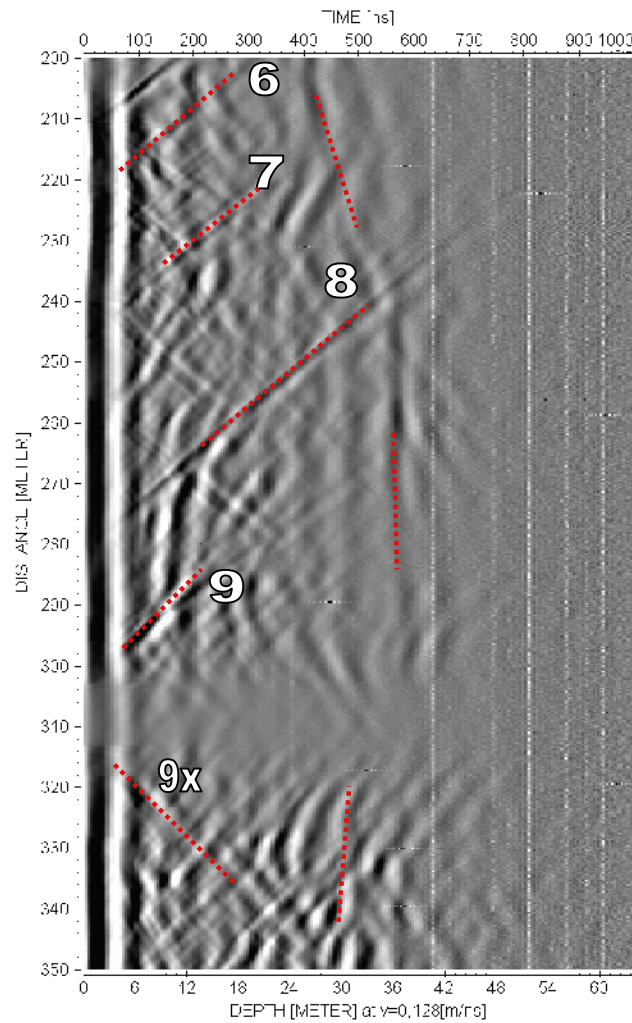

200-350 m

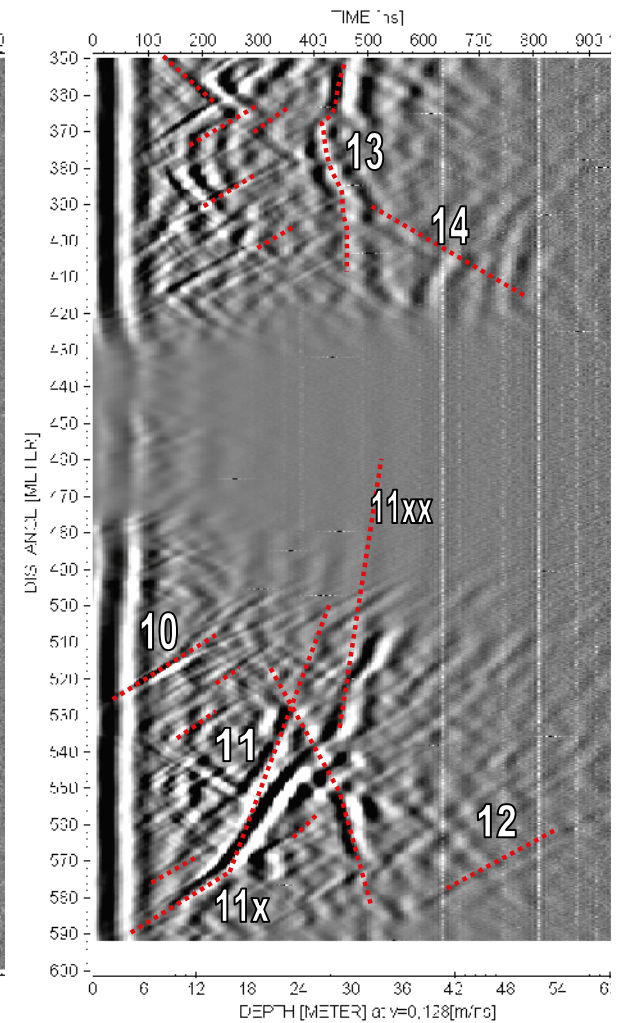

350-600 m

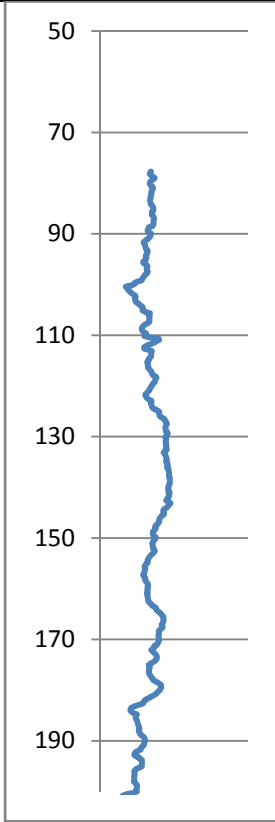

50-200m

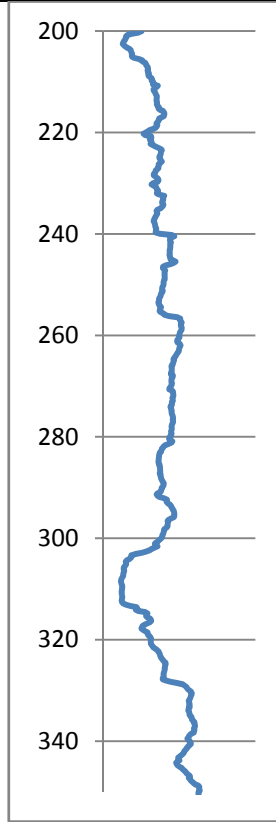

200-350 m

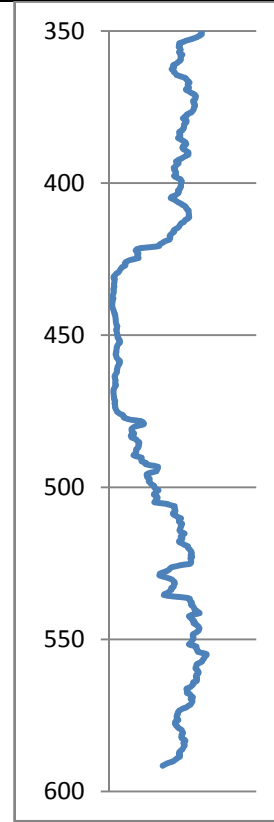

350-600 m

Radar logging in KFR104. 6 to 445 m. Dipole antenna 20 MHz

FORSMARK KFR104 20 MHz data

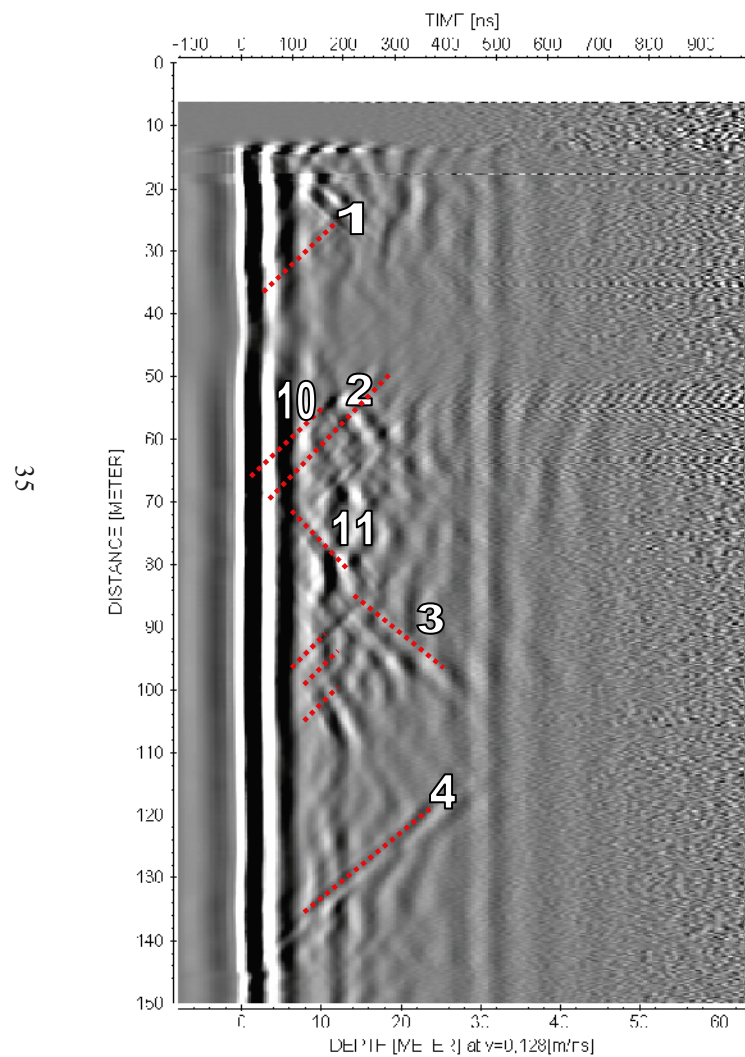

0-150 m

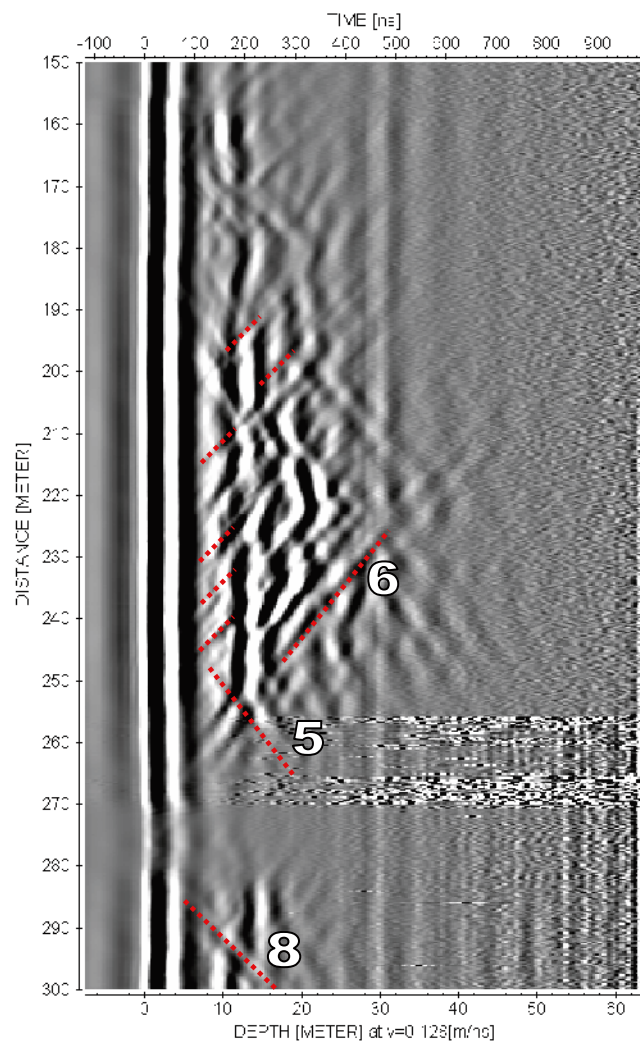

150-300 m

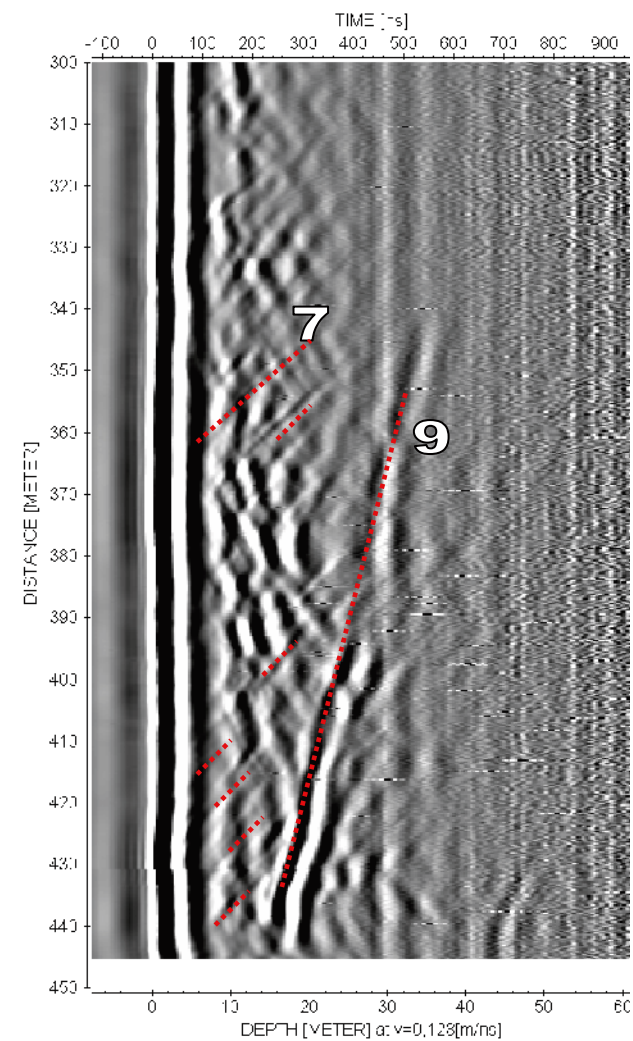

300-450 m

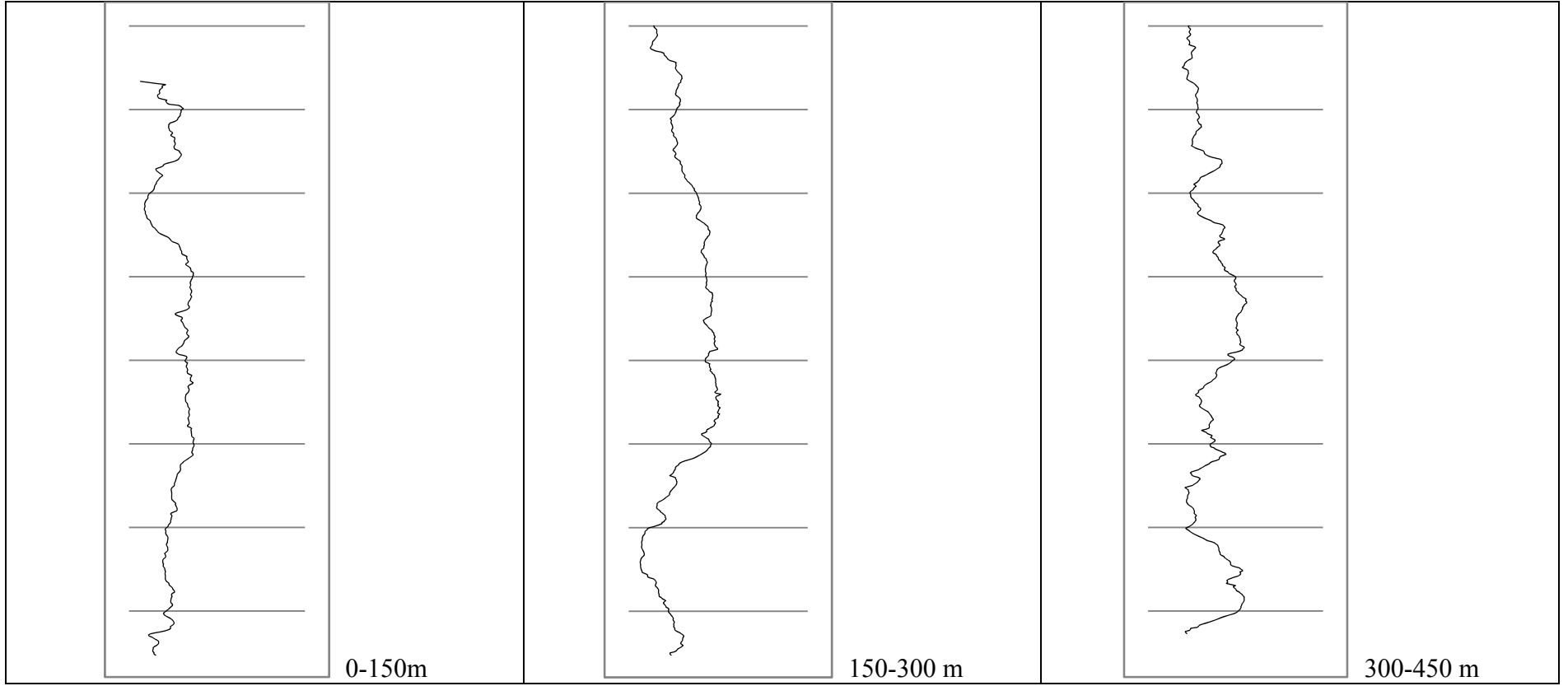

Appendix 4

Project name: SFR

Image file : c:\work\r5754s~1\2009-0~1\bipskf~1\kfr102a.bip
BDT file : c:\work\r5754s~1\2009-0~1\bipskf~1\kfr102a.bdt
Locality : SFR
Bore hole number : KFR102A
Date : 09/01/14
Time : 16:49:00
Depth range : 71.000 - 597.662 m
Azimuth : 302
Inclination : -65
Diameter : 76.0 mm
Magnetic declination : 0.0
Span : 4
Scan interval : 0.25
Scan direction : To bottom
Scale : 1/25
Aspect ratio : 175 %
Pages : 27
Color : 
 +0 +0 +0

Depth range: 60.000 - 80.000 m

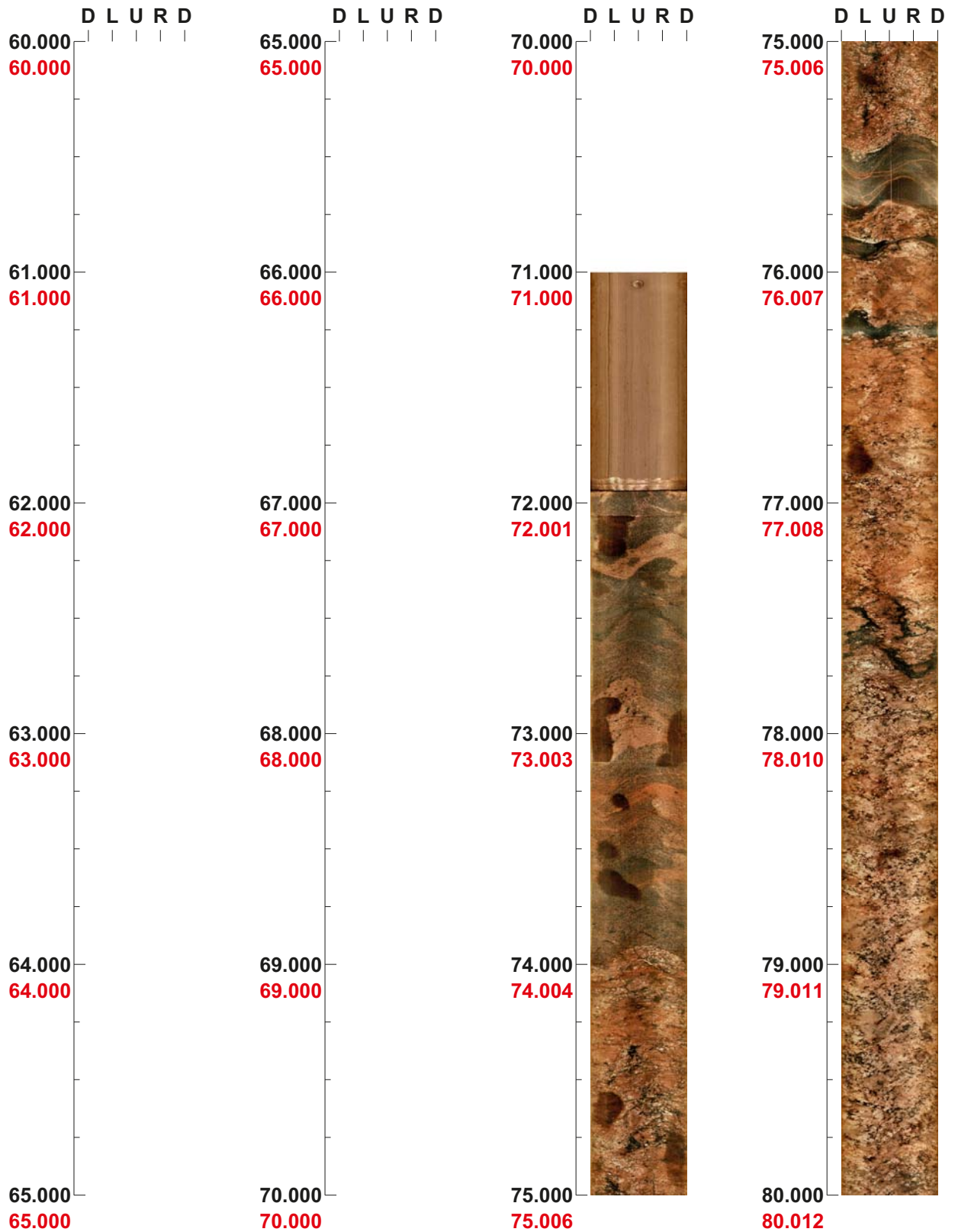

Project name: SFR
Bore hole No.: KFR102A

Azimuth: 302 Inclination: -65

Depth range: 80.000 - 100.000 m

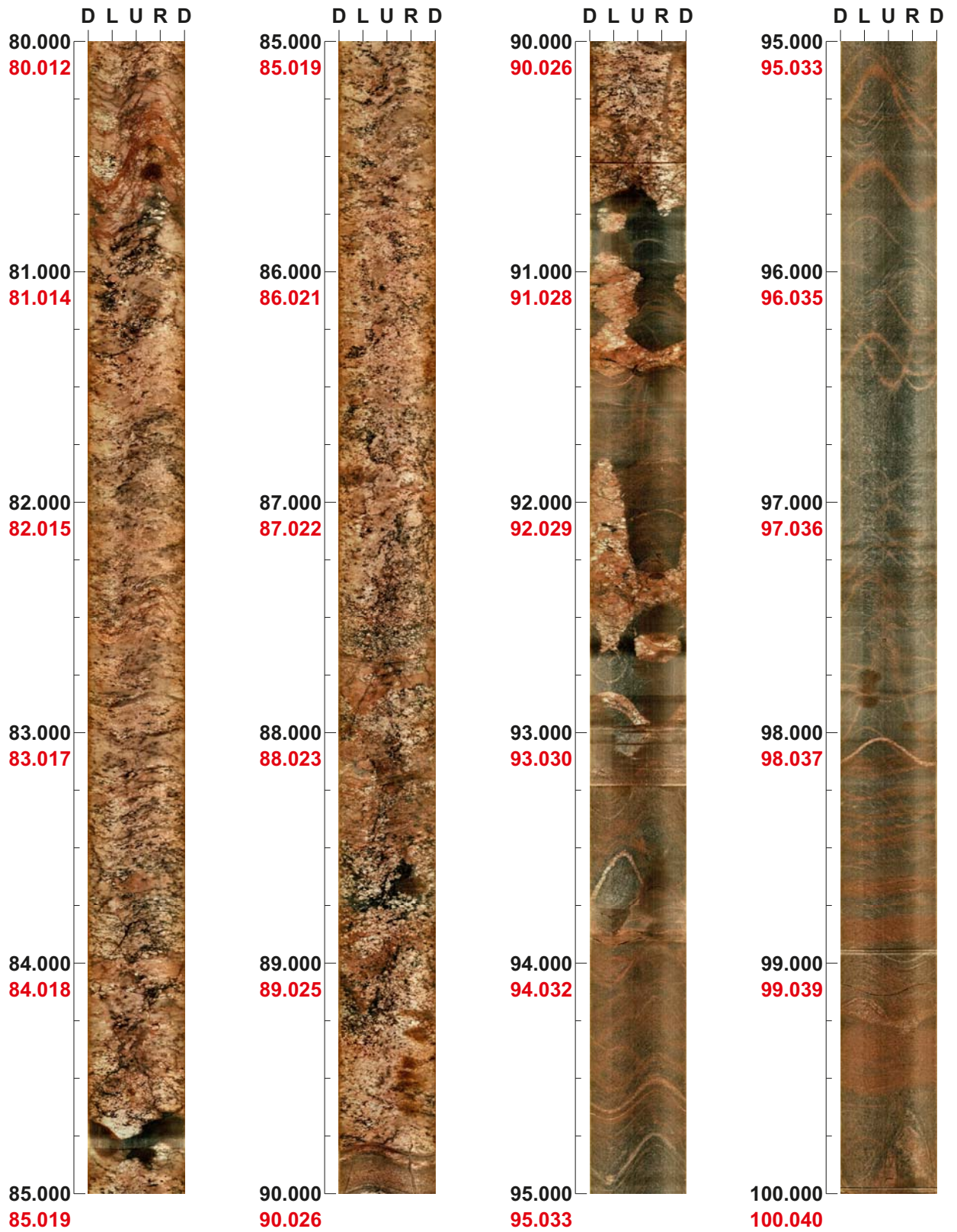

Project name: SFR
Bore hole No.: KFR102A

Azimuth: 302 Inclination: -65

Depth range: 100.000 - 120.000 m

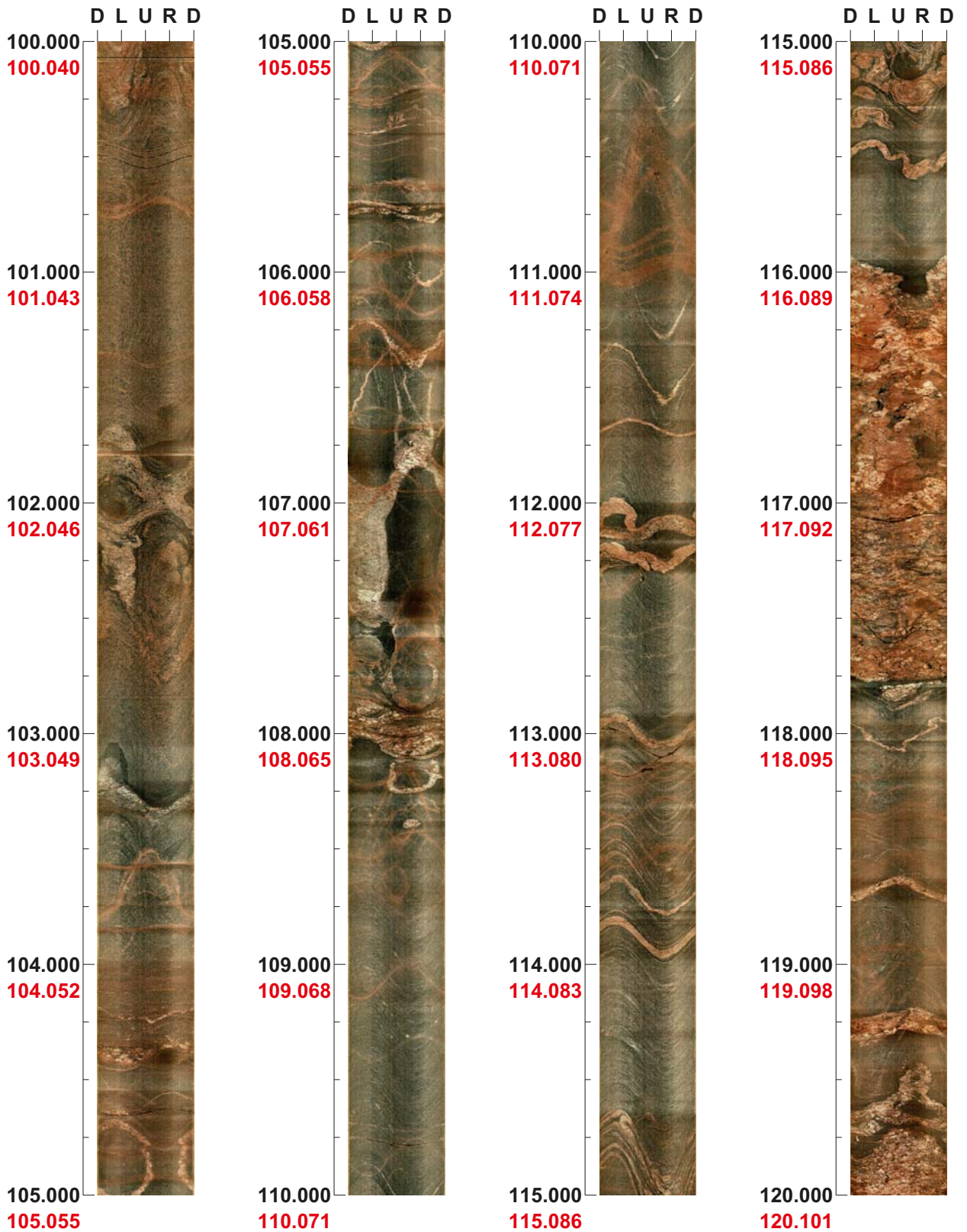

Project name: SFR
Bore hole No.: KFR102A

Azimuth: 302 Inclination: -65

Depth range: 120.000 - 140.000 m

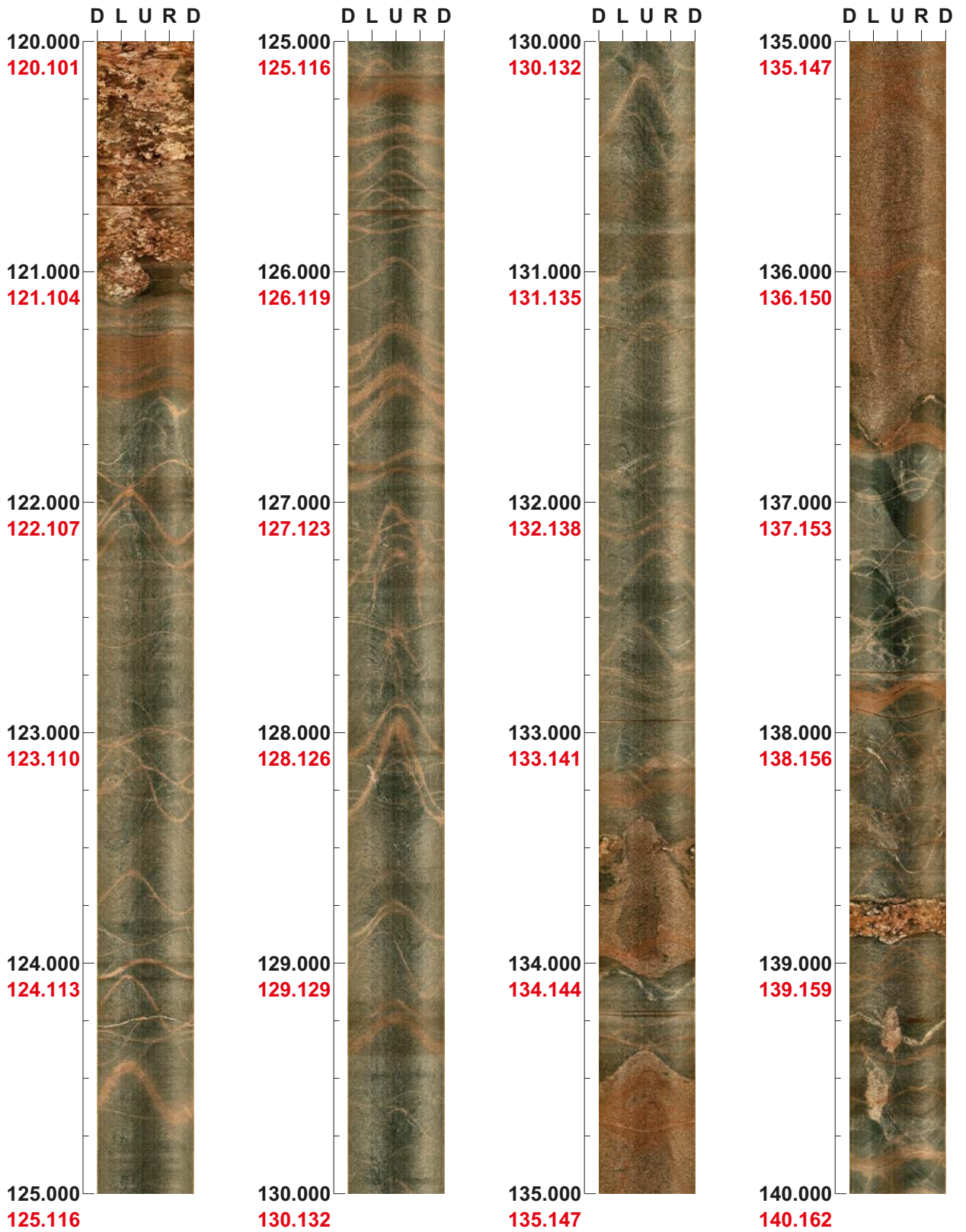

Project name: SFR
Bore hole No.: KFR102A

Azimuth: 302 Inclination: -65

Depth range: 140.000 - 160.000 m

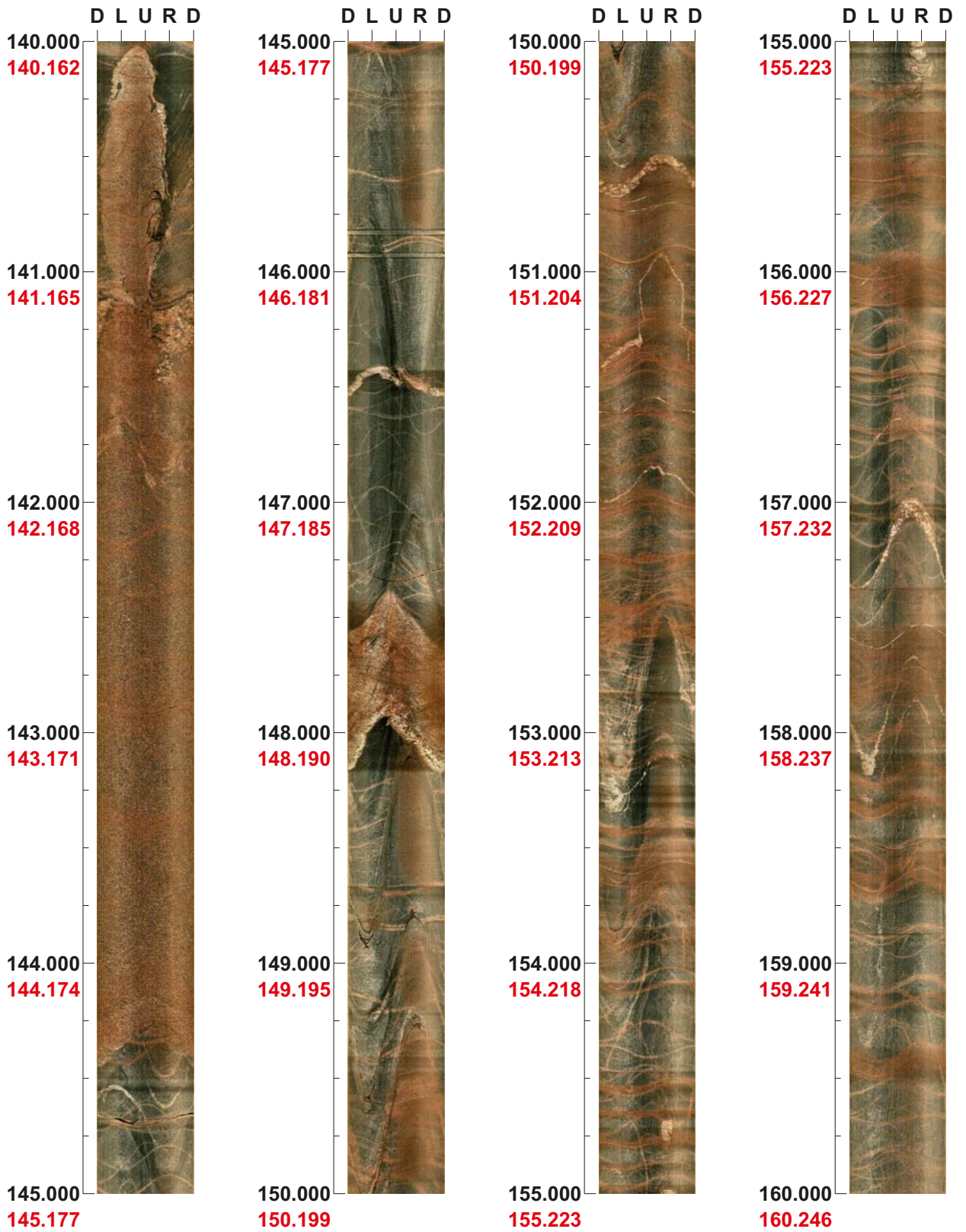

Project name: SFR
Bore hole No.: KFR102A

Azimuth: 302 Inclination: -65

Depth range: 160.000 - 180.000 m

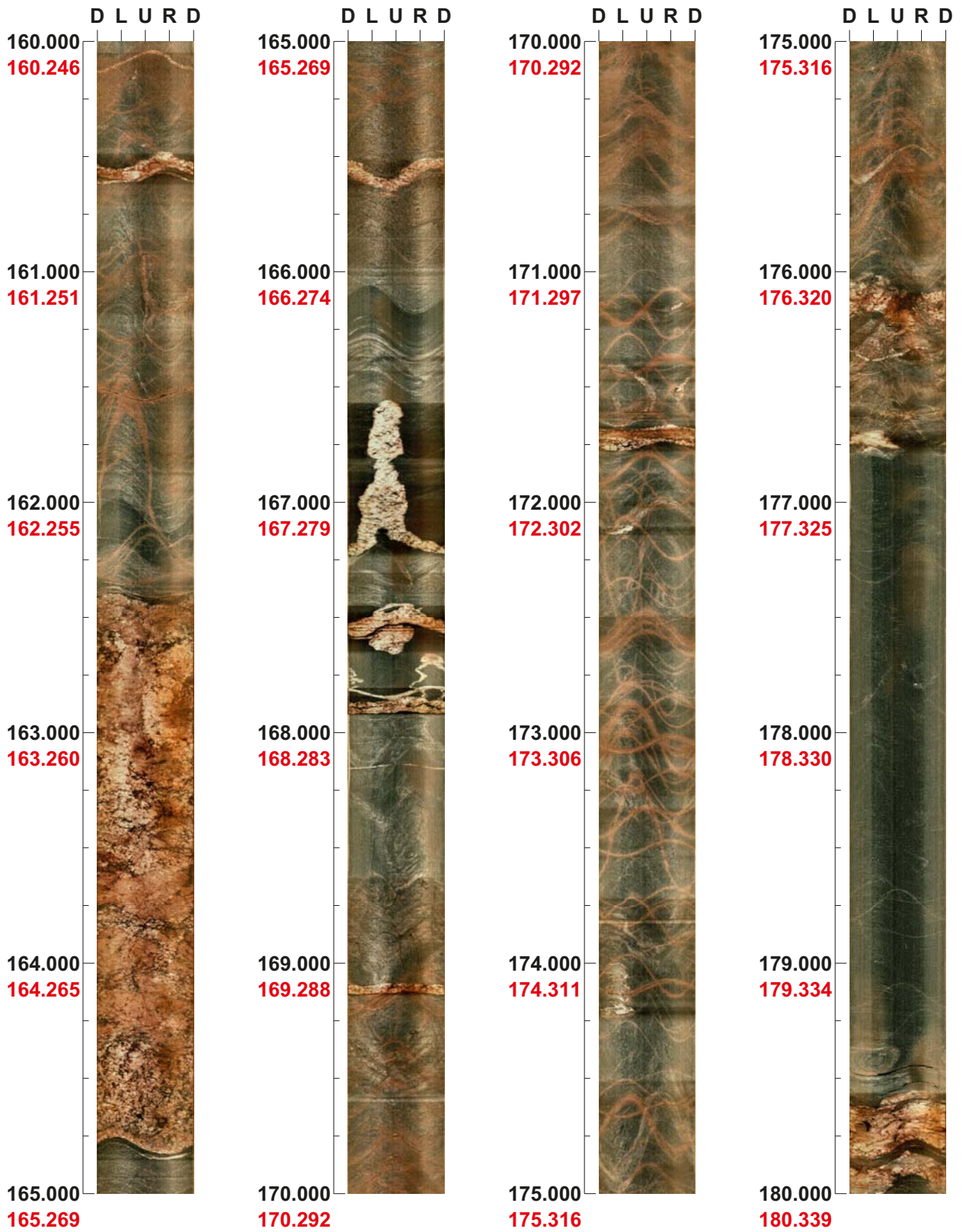

Project name: SFR
Bore hole No.: KFR102A

Azimuth: 302 Inclination: -65

Depth range: 180.000 - 200.000 m

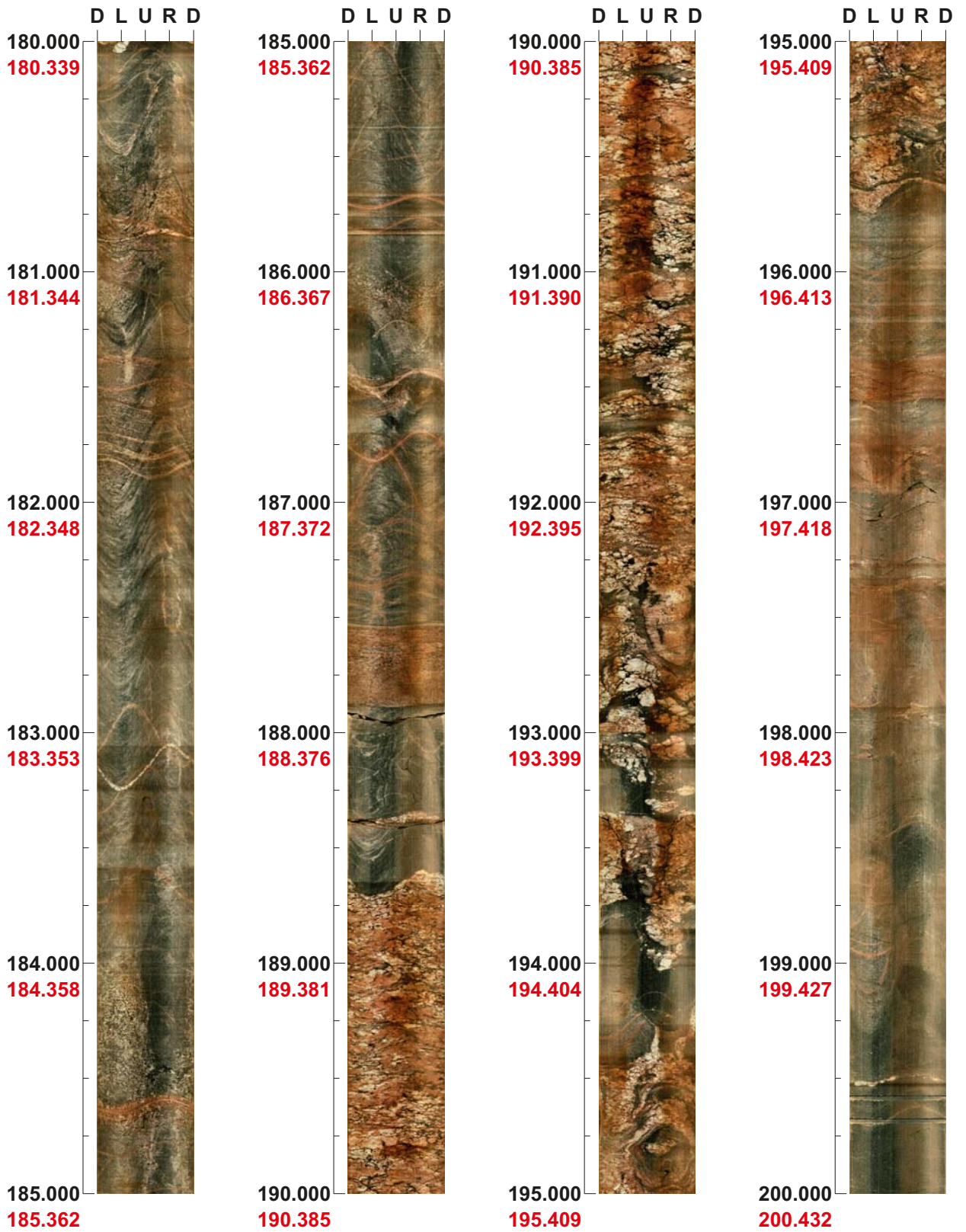

Project name: SFR
Bore hole No.: KFR102A

Azimuth: 302 Inclination: -65

Depth range: 200.000 - 220.000 m

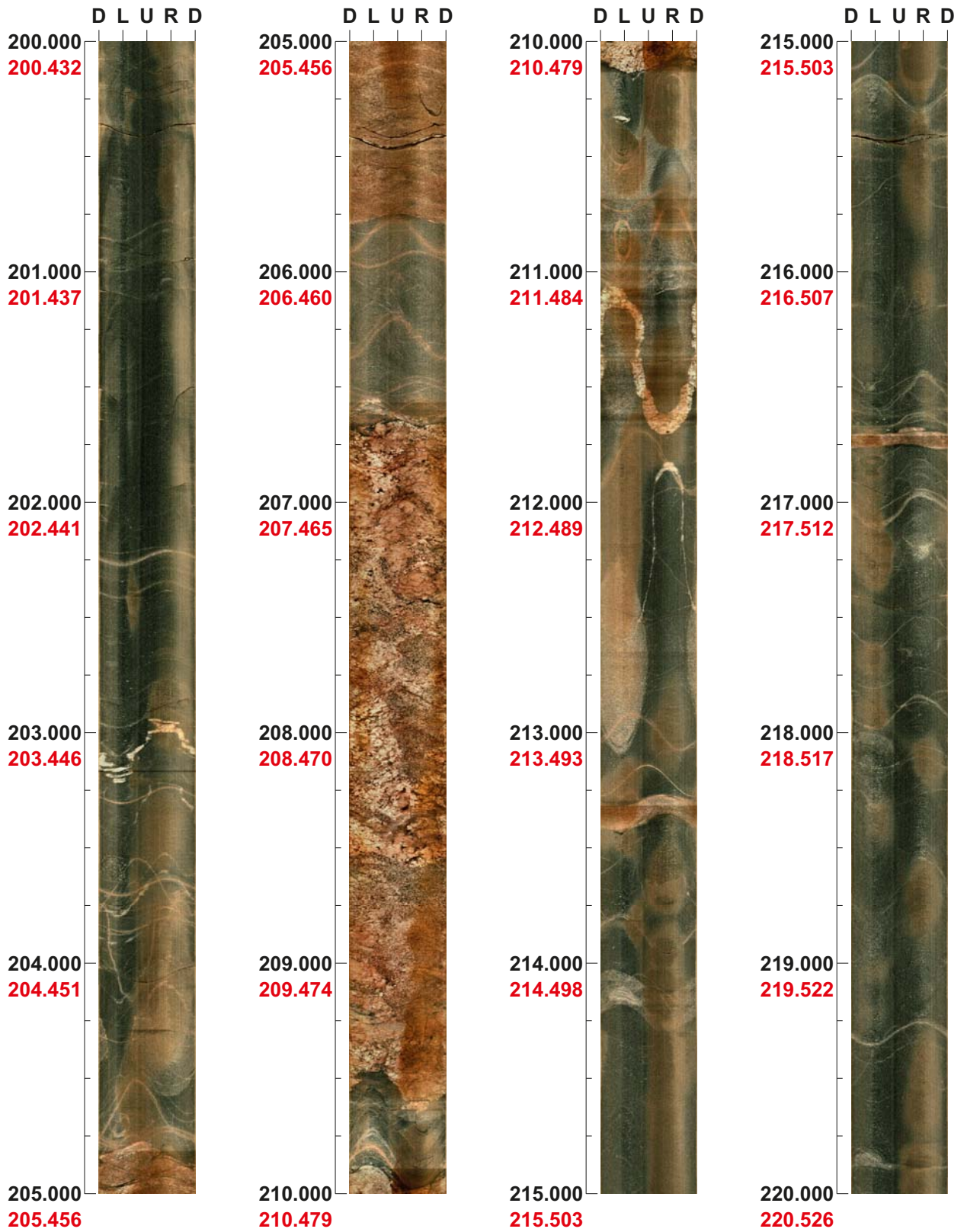

Depth range: 220.000 - 240.000 m



Project name: SFR
Bore hole No.: KFR102A

Azimuth: 302 Inclination: -65

Depth range: 240.000 - 260.000 m

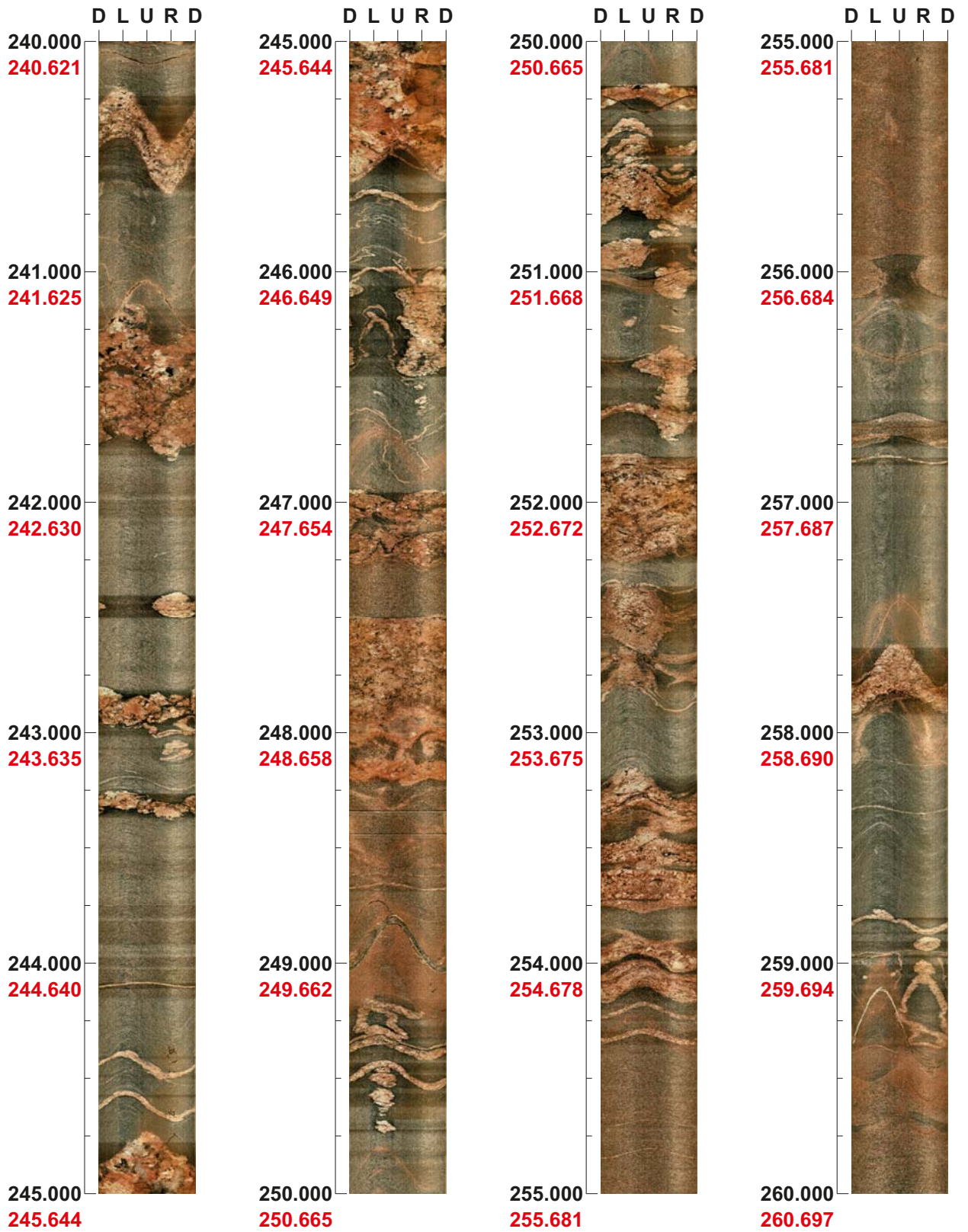

Project name: SFR
Bore hole No.: KFR102A

Azimuth: 302 Inclination: -65

Depth range: 260.000 - 280.000 m

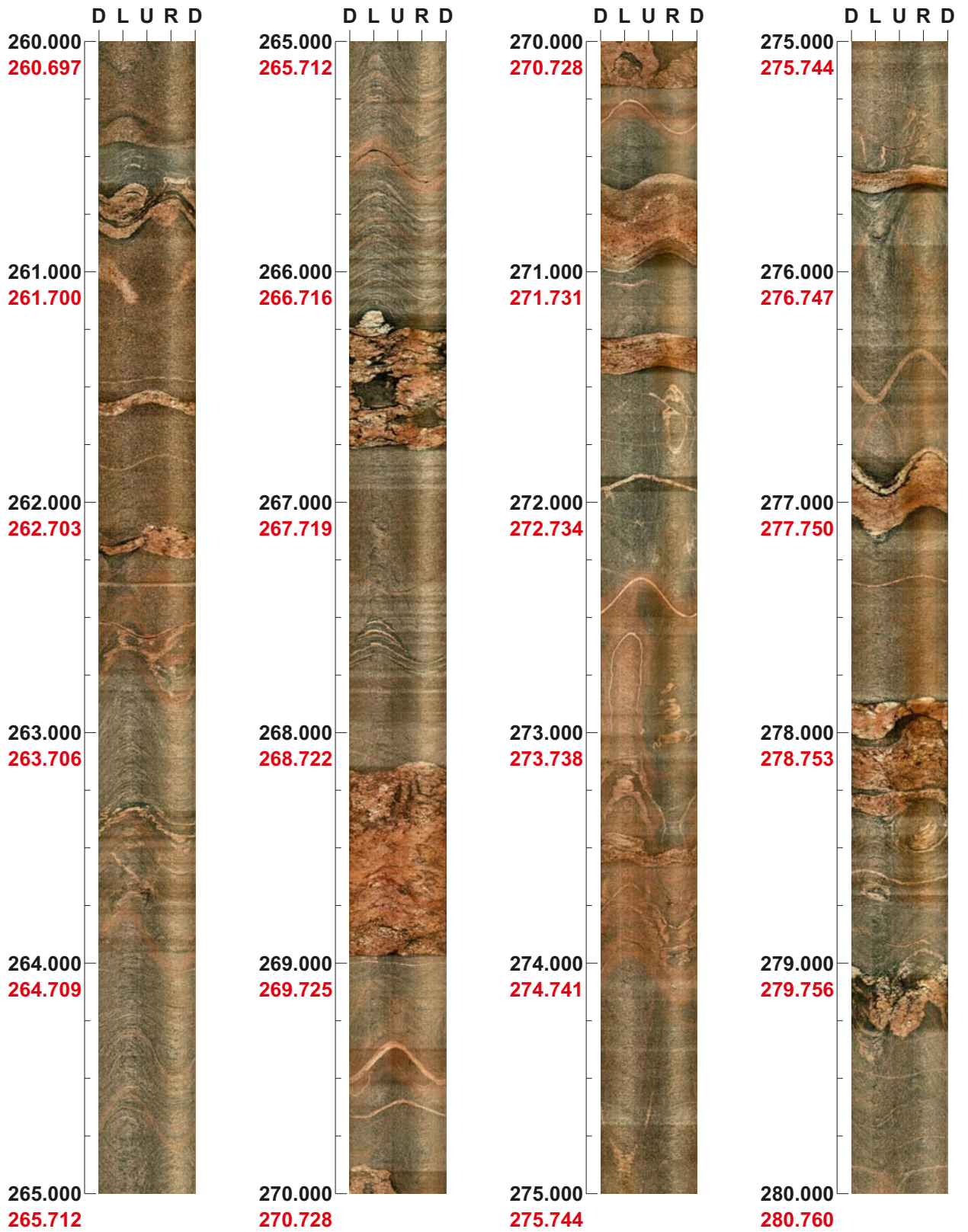

Project name: SFR
Bore hole No.: KFR102A

Azimuth: 302 Inclination: -65

Depth range: 280.000 - 300.000 m

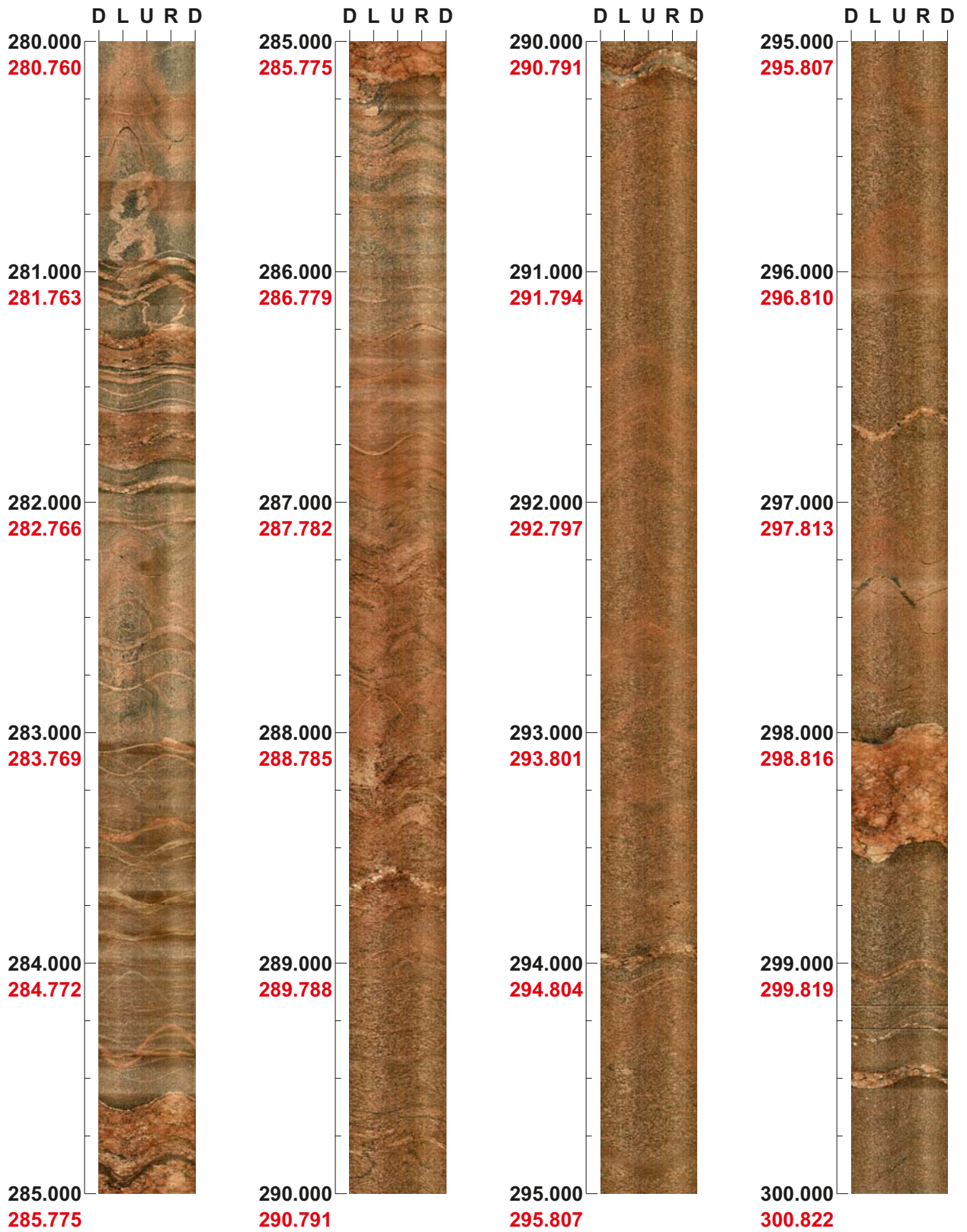

Project name: SFR
Bore hole No.: KFR102A

Azimuth: 302 Inclination: -65

Depth range: 300.000 - 320.000 m

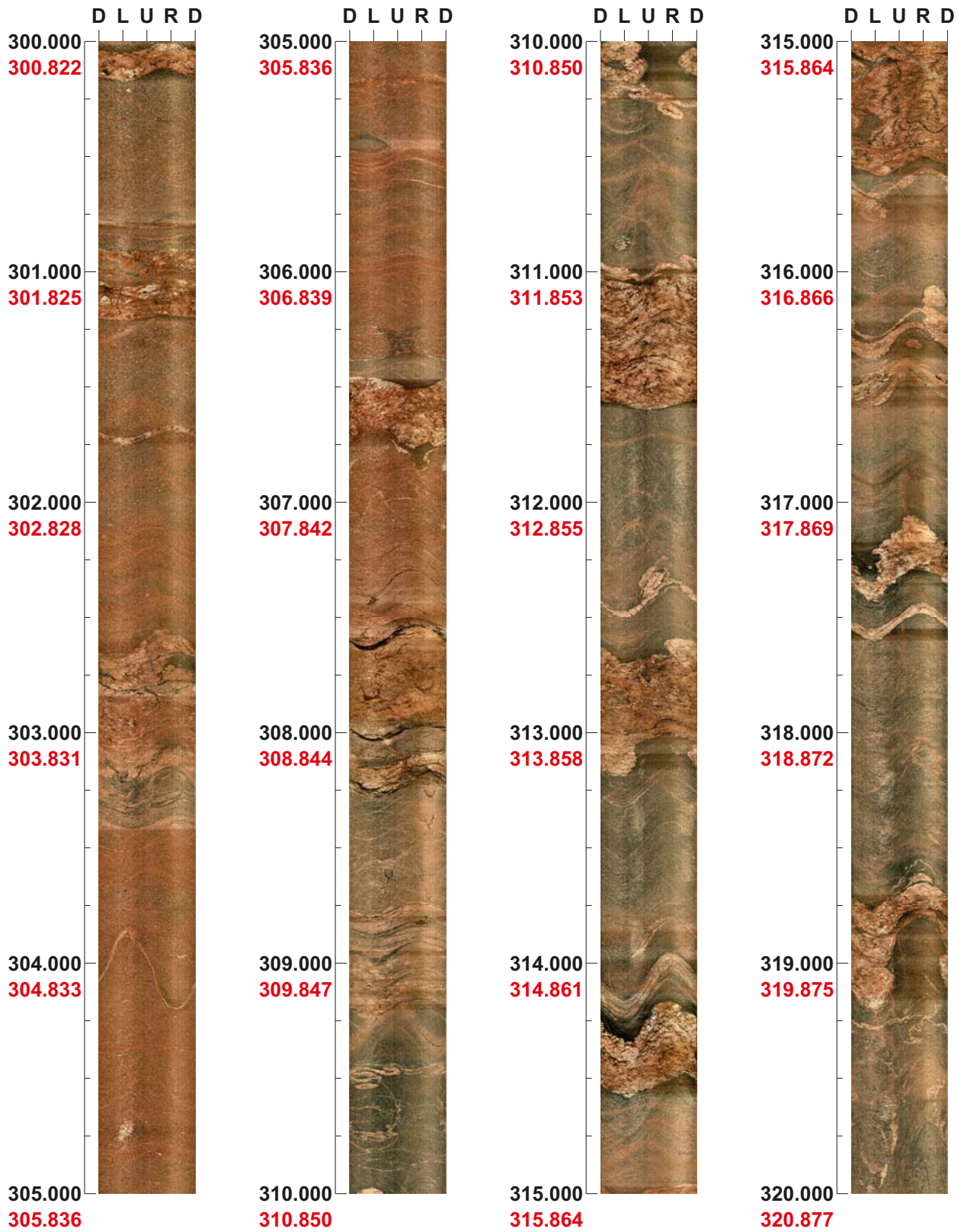

Project name: SFR
Bore hole No.: KFR102A

Azimuth: 302 Inclination: -65

Depth range: 320.000 - 340.000 m

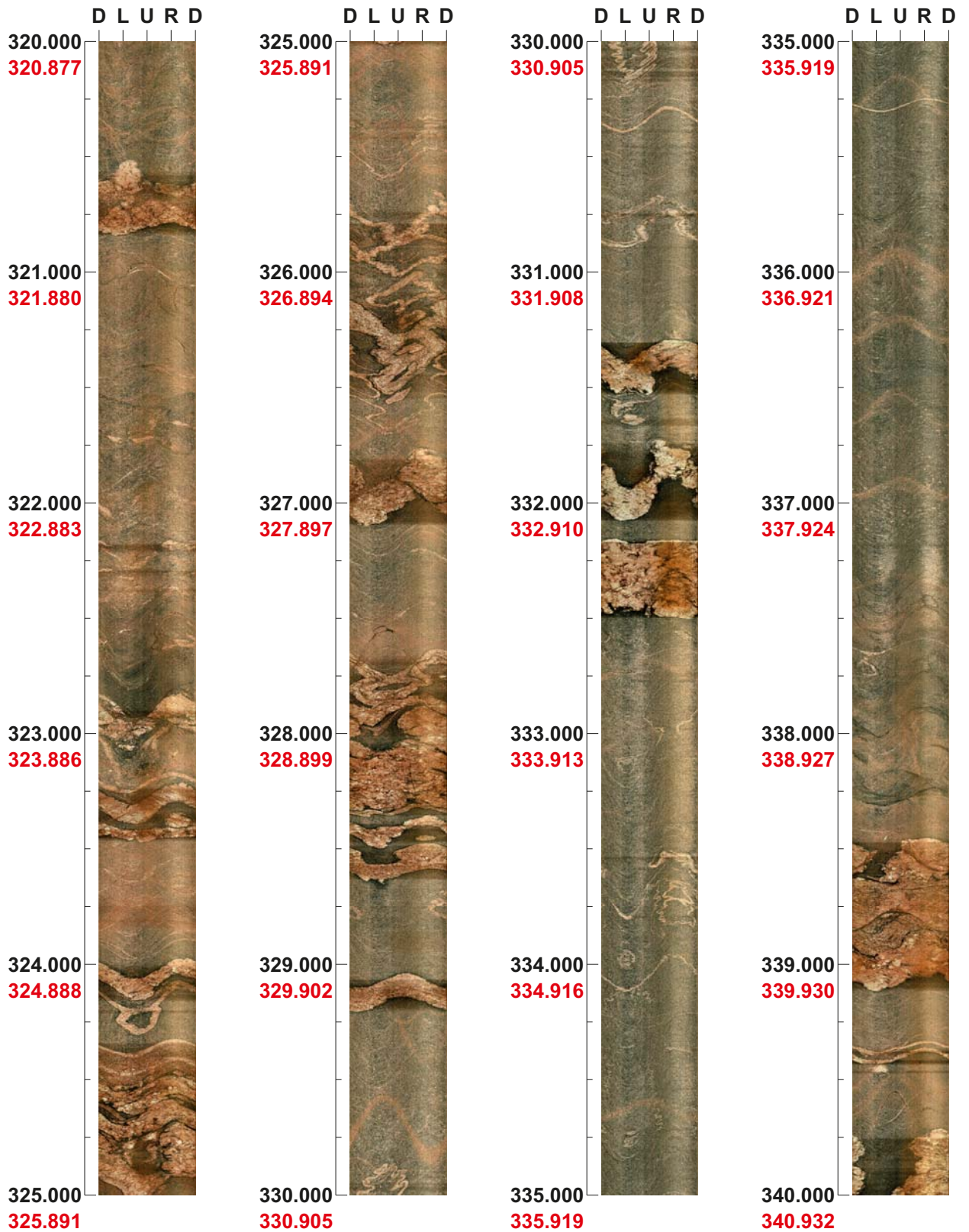

Project name: SFR
Bore hole No.: KFR102A

Azimuth: 302 Inclination: -65

Depth range: 340.000 - 360.000 m

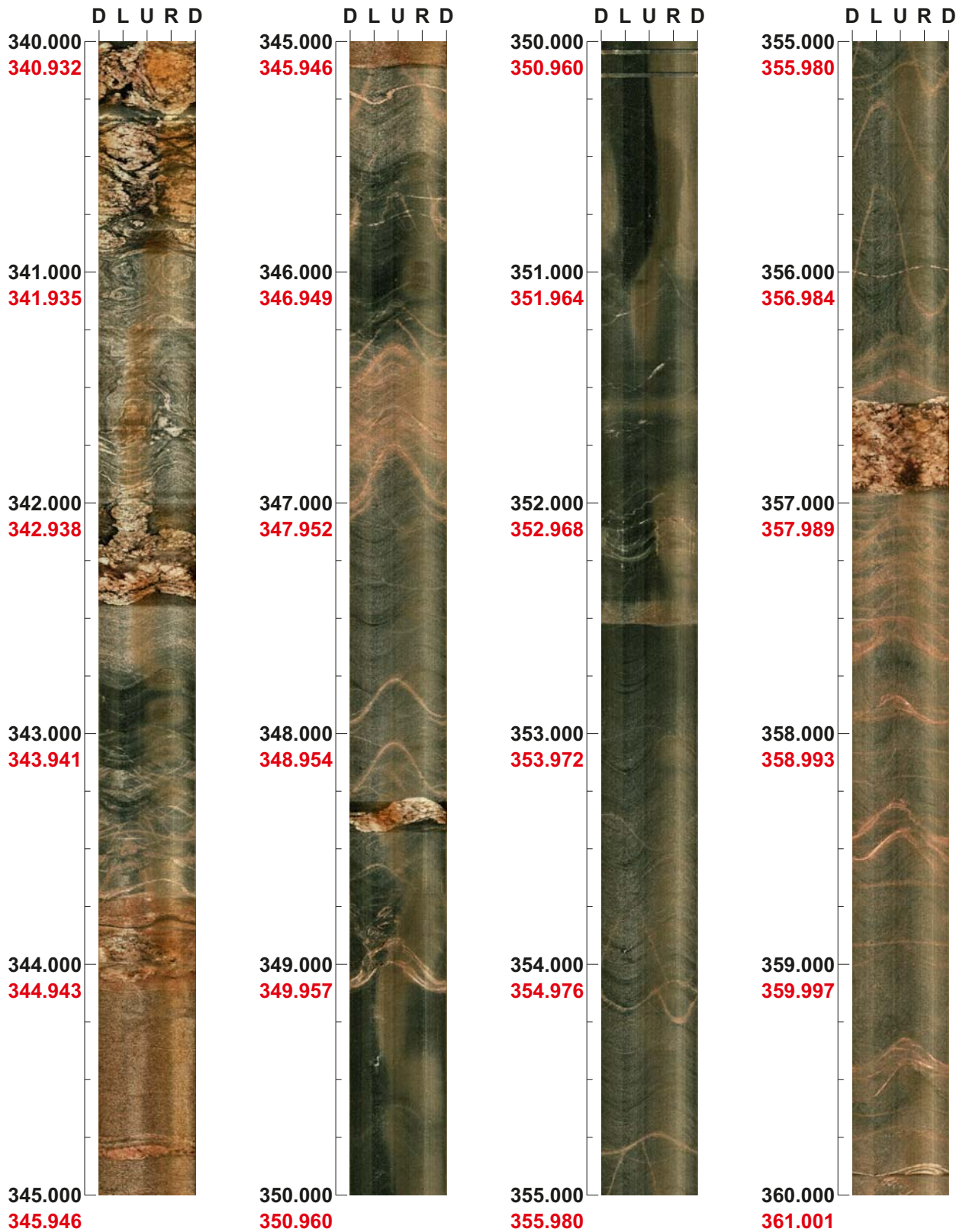

Depth range: 360.000 - 380.000 m

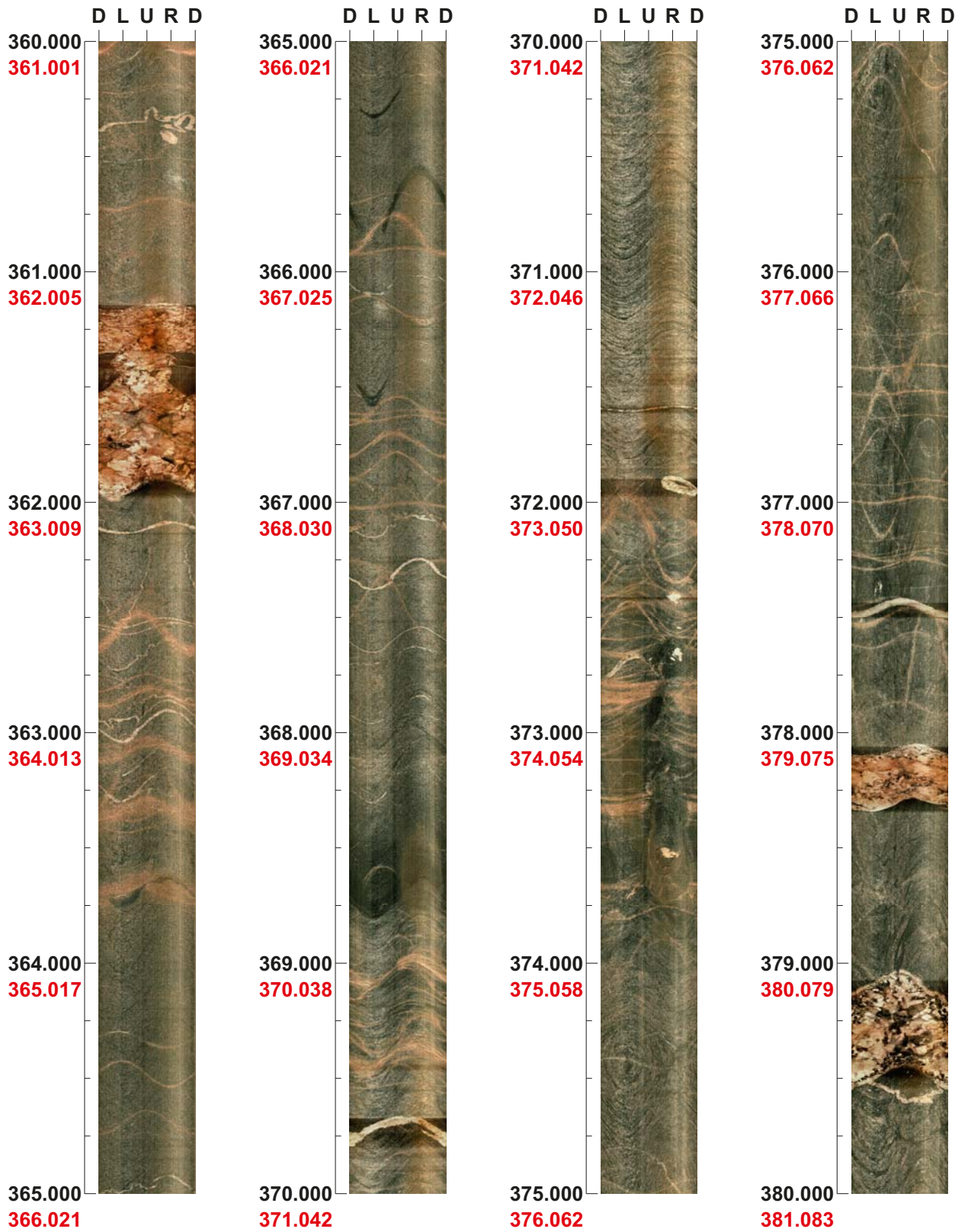

Project name: SFR
Bore hole No.: KFR102A

Azimuth: 302 Inclination: -65

Depth range: 380.000 - 400.000 m

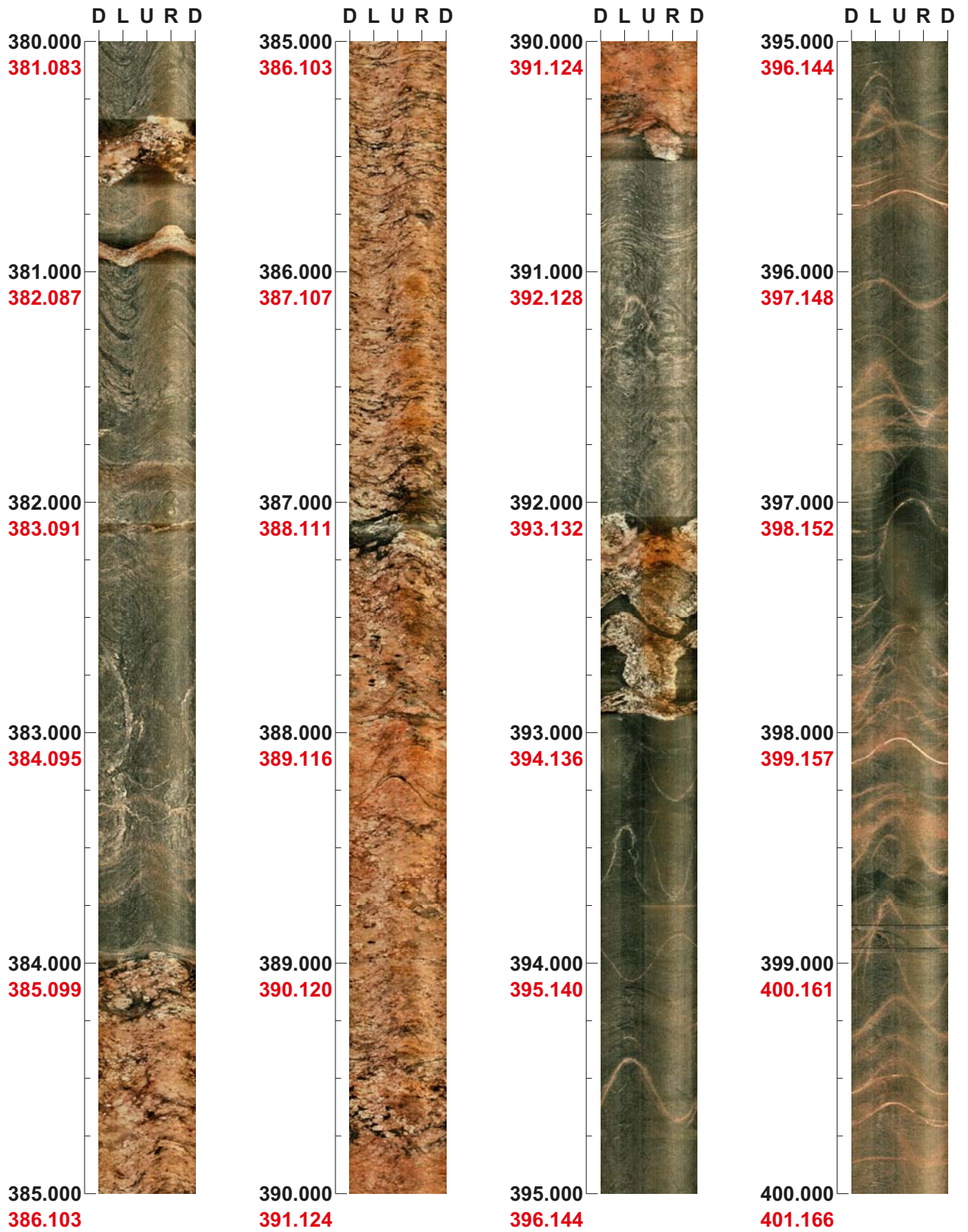

Project name: SFR
Bore hole No.: KFR102A

Azimuth: 302 Inclination: -65

Depth range: 400.000 - 420.000 m

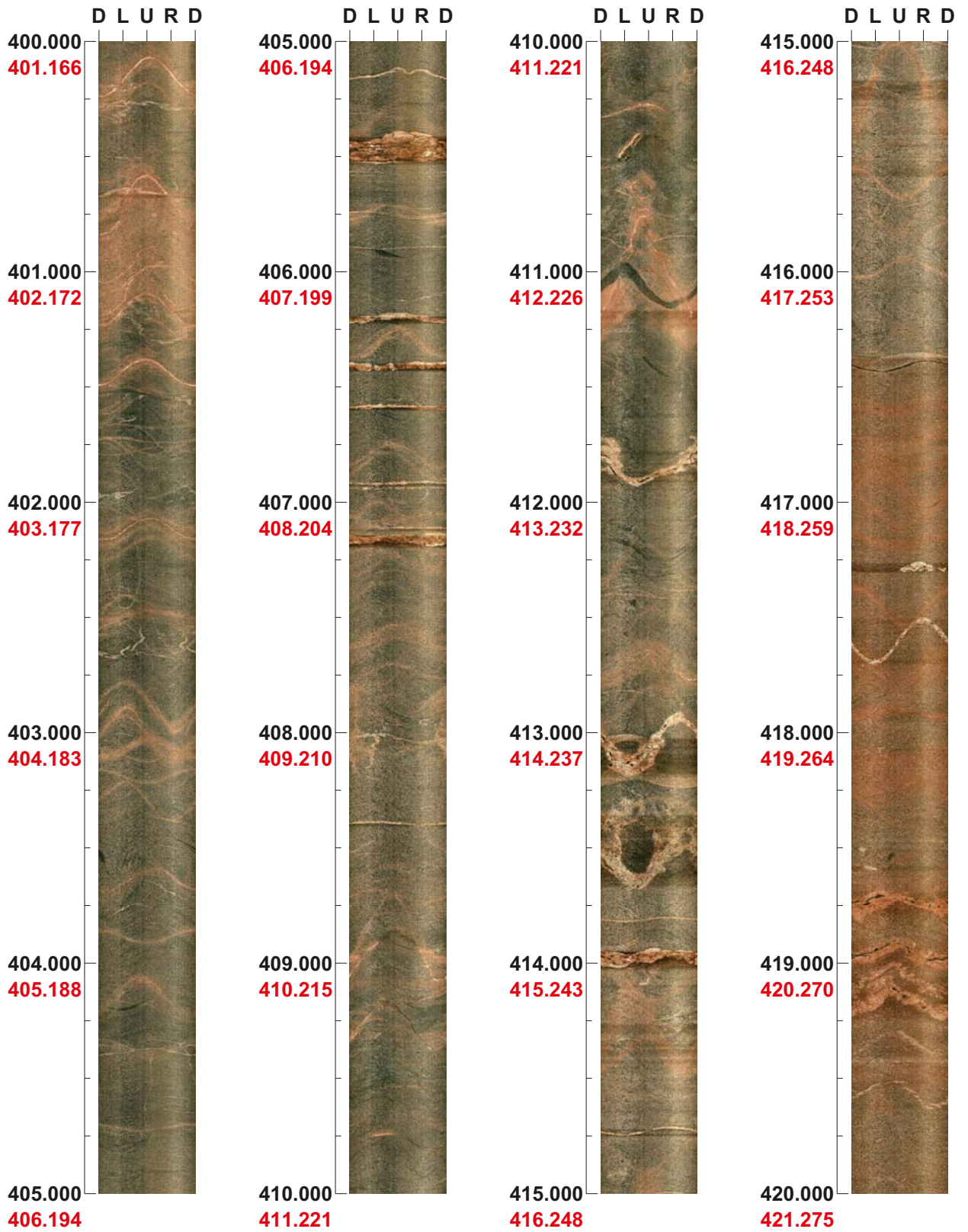

Depth range: 420.000 - 440.000 m

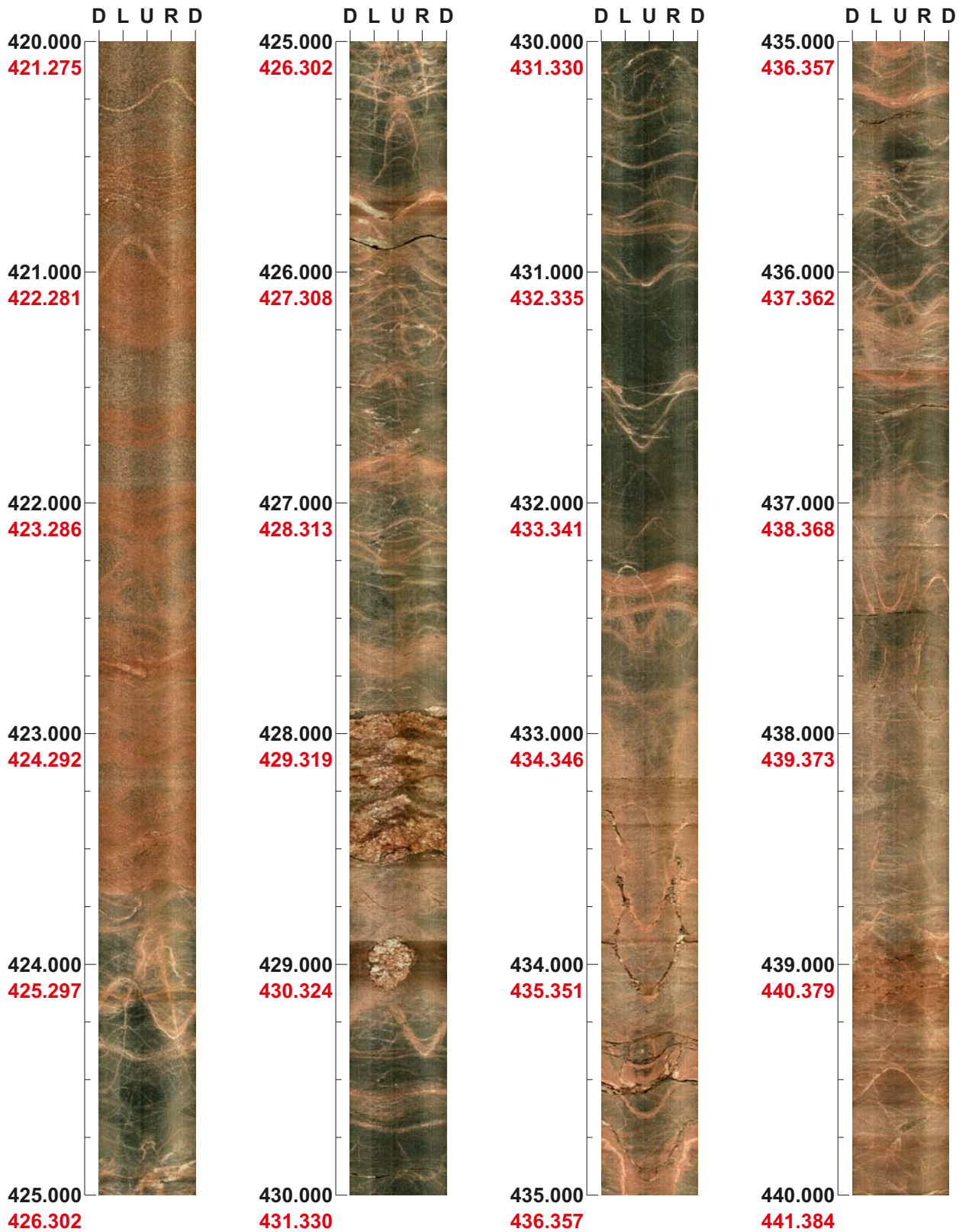

Project name: SFR
Bore hole No.: KFR102A

Azimuth: 302 Inclination: -65

Depth range: 440.000 - 460.000 m

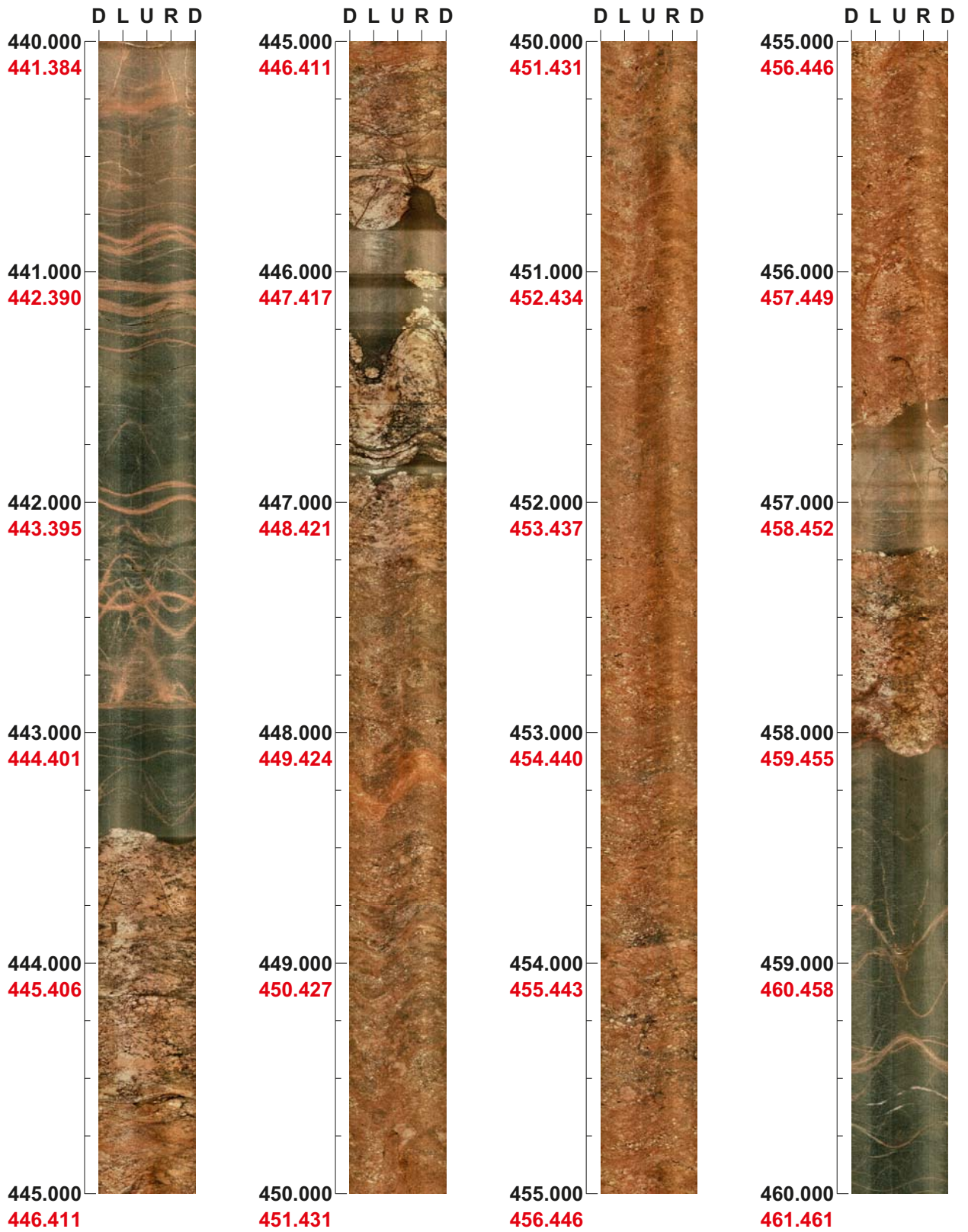

Depth range: 460.000 - 480.000 m

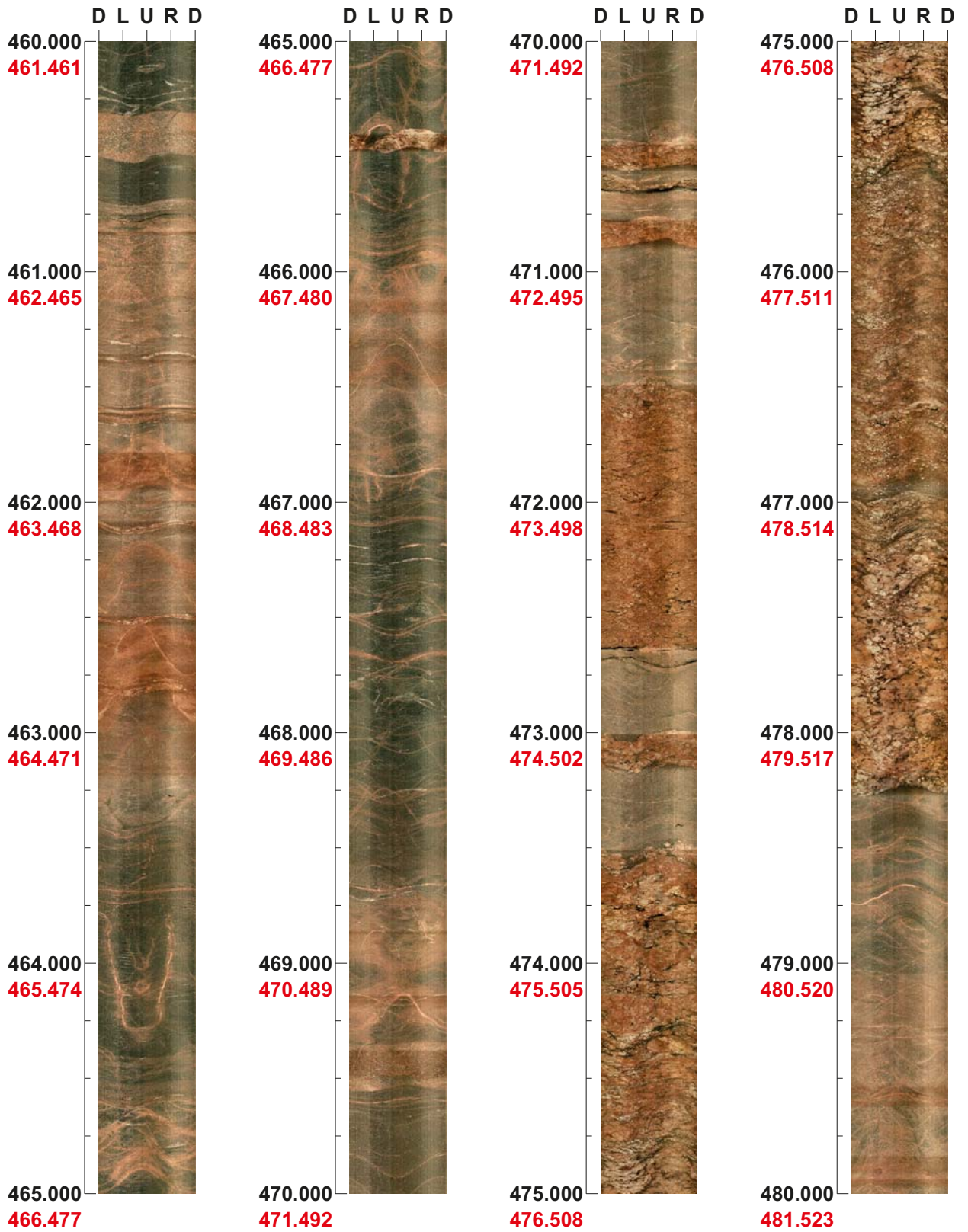

Depth range: 480.000 - 500.000 m

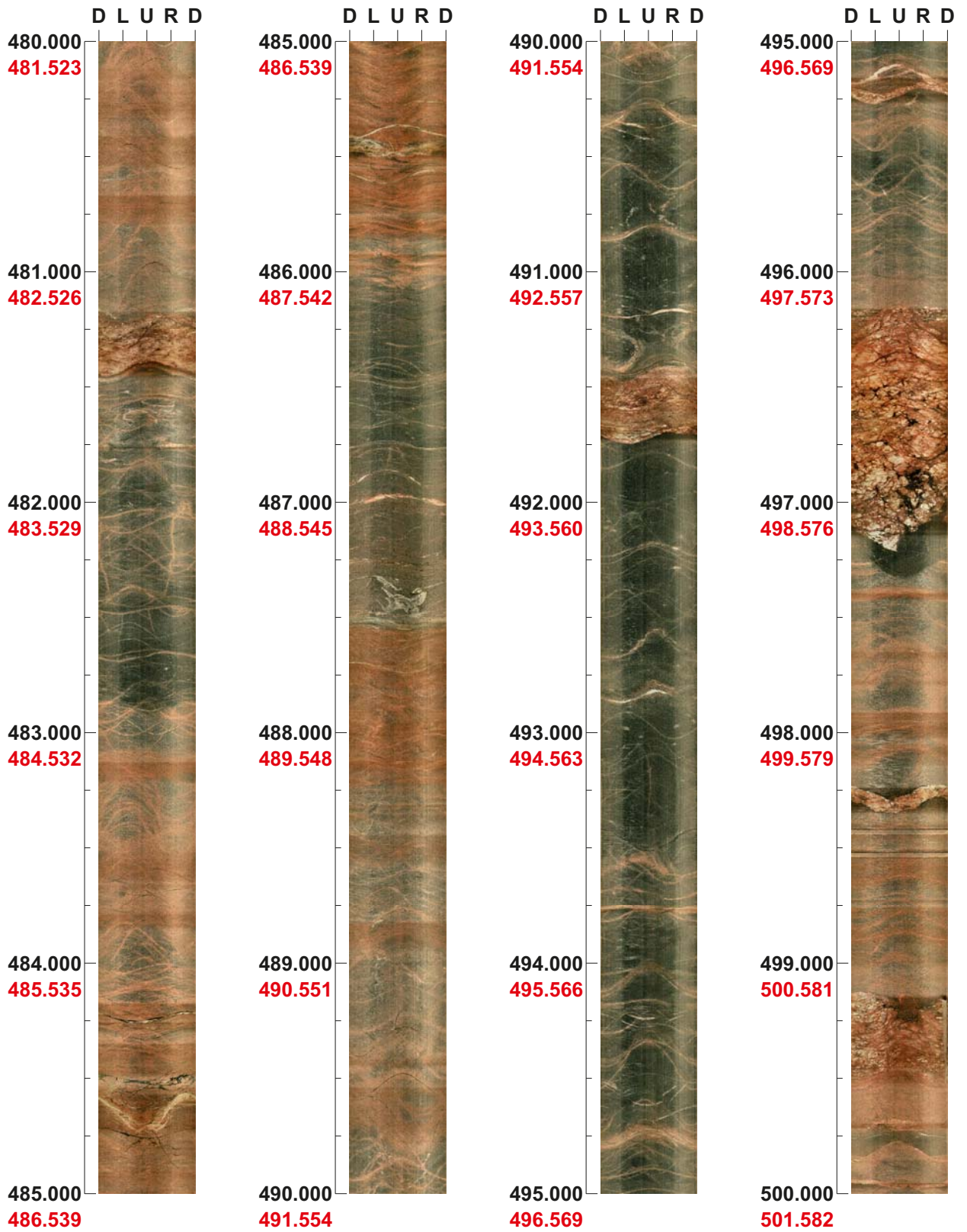

Project name: SFR
Bore hole No.: KFR102A

Azimuth: 302 Inclination: -65

Depth range: 500.000 - 520.000 m

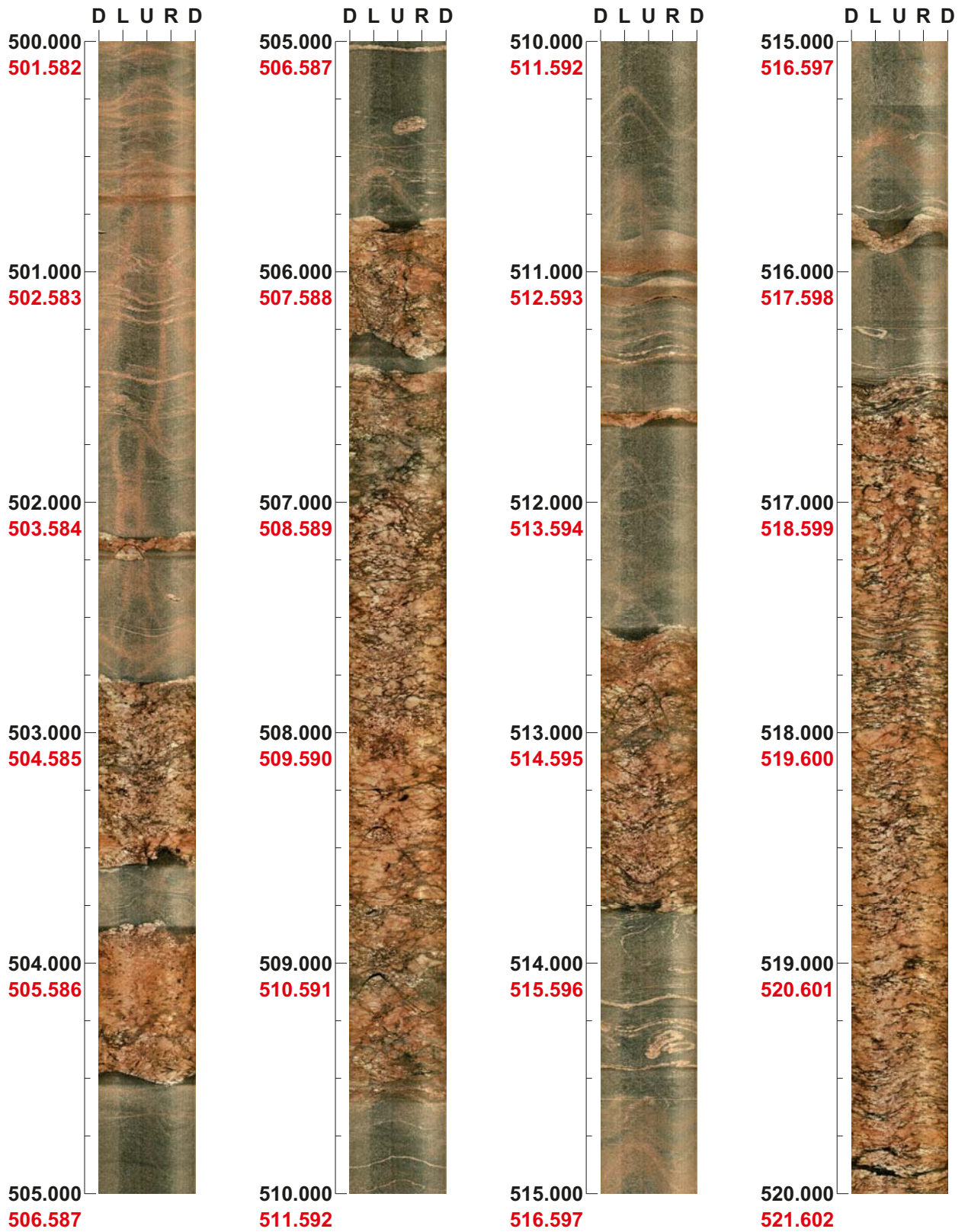

Project name: SFR
Bore hole No.: KFR102A

Azimuth: 302 Inclination: -65

Depth range: 520.000 - 540.000 m



Project name: SFR
Bore hole No.: KFR102A

Azimuth: 302 Inclination: -65

Depth range: 540.000 - 560.000 m

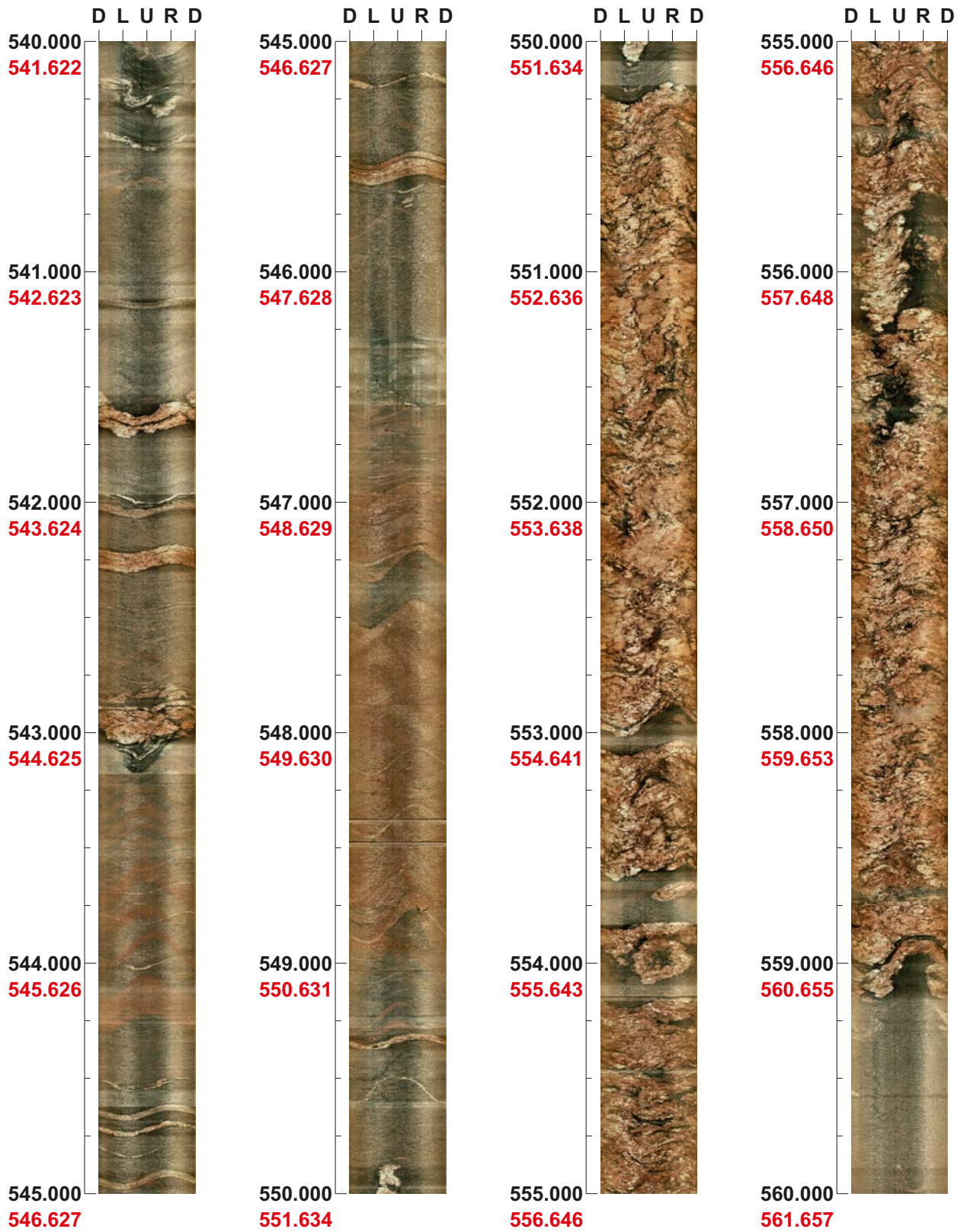

Depth range: 560.000 - 580.000 m



Depth range: 580.000 - 597.662 m



Project name: SFR
Bore hole No.: KFR102B

Azimuth: 345 Inclination: -54

Depth range: 0.000 - 20.000 m

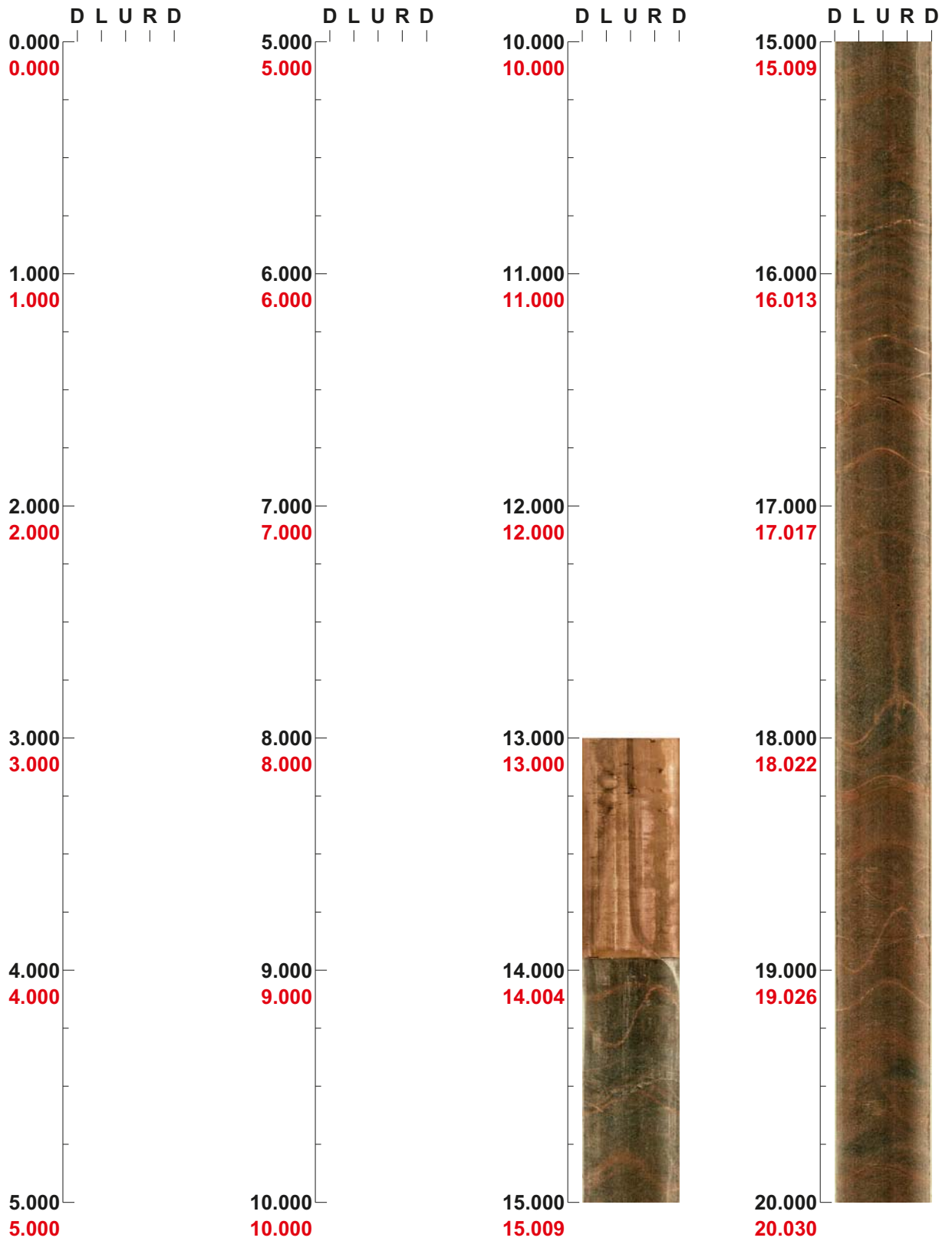

Project name: SFR
Bore hole No.: KFR102B

Azimuth: 345 Inclination: -54

Depth range: 20.000 - 40.000 m



Project name: SFR
Bore hole No.: KFR102B

Azimuth: 345 Inclination: -54

Depth range: 40.000 - 60.000 m



Project name: SFR
Bore hole No.: KFR102B

Azimuth: 345 Inclination: -54

Depth range: 60.000 - 80.000 m



Depth range: 80.000 - 100.000 m



Depth range: 100.000 - 120.000 m



Project name: SFR
Bore hole No.: KFR102B

Azimuth: 345 Inclination: -54

Depth range: 120.000 - 140.000 m



Depth range: 140.000 - 160.000 m



Depth range: 160.000 - 178.712 m

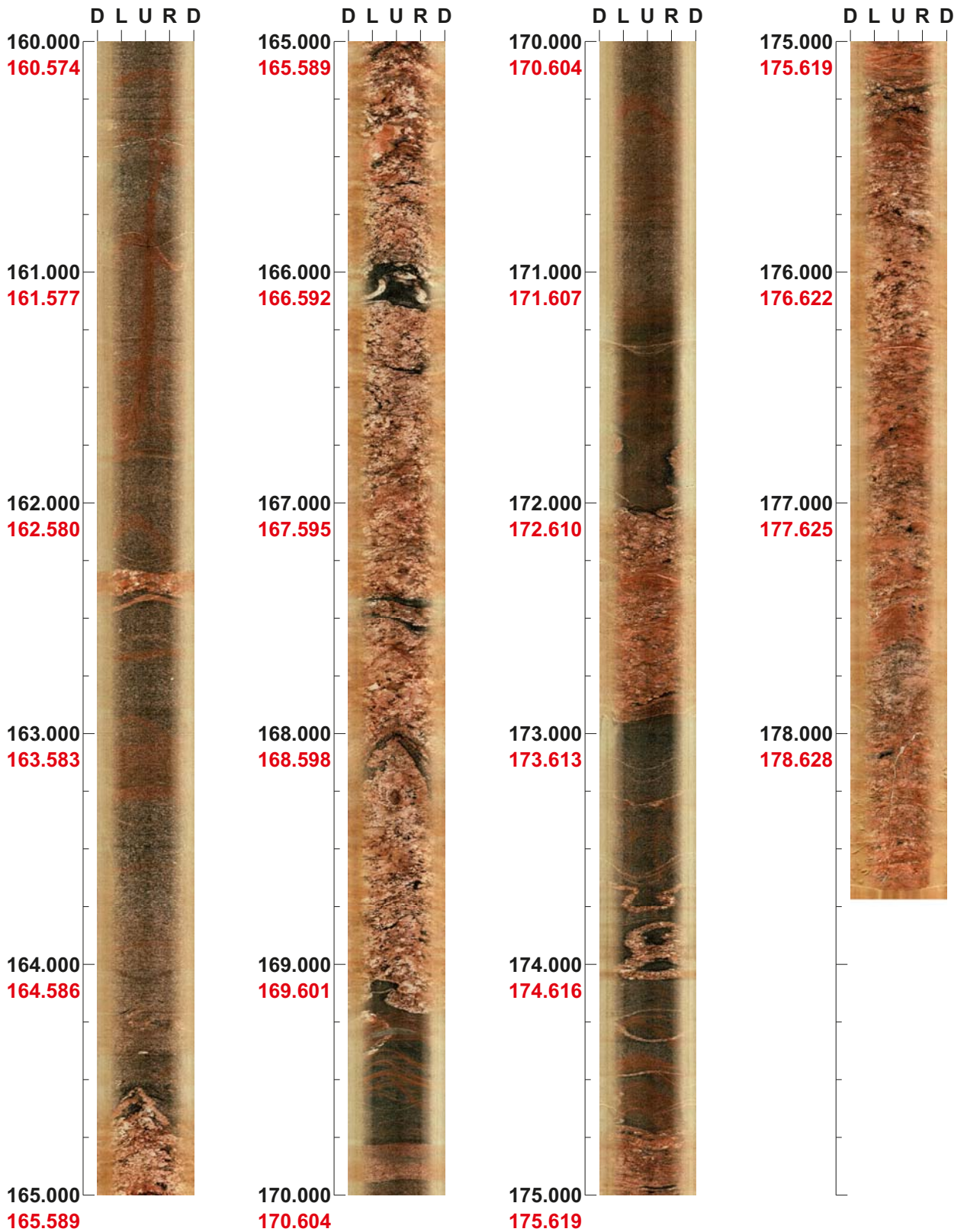

Project name: SFR
Bore hole No.: KFR103

Azimuth: 180 Inclination: -54

Depth range: 0.000 - 20.000 m

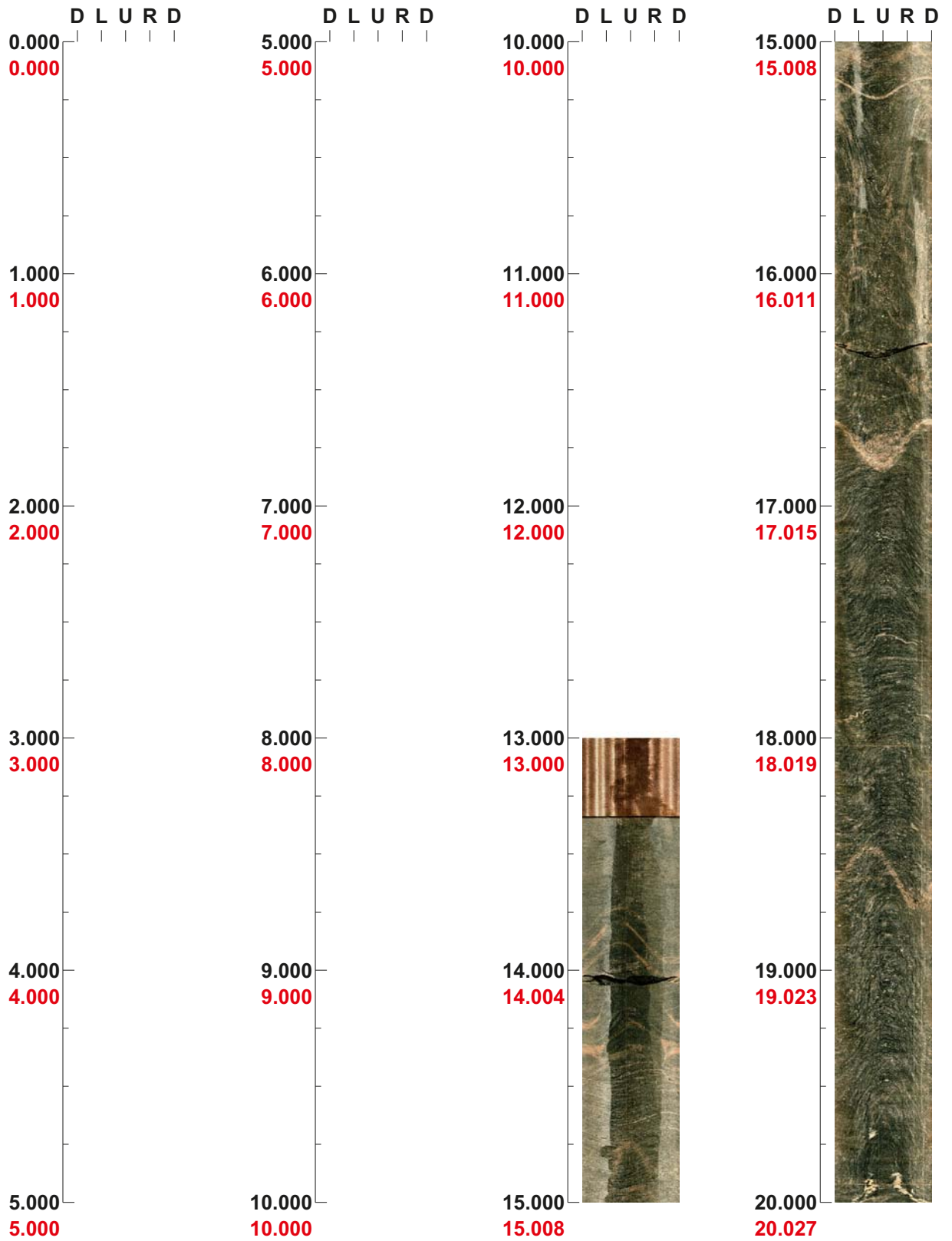

Project name: SFR
Bore hole No.: KFR103

Azimuth: 180 Inclination: -54

Depth range: 20.000 - 40.000 m

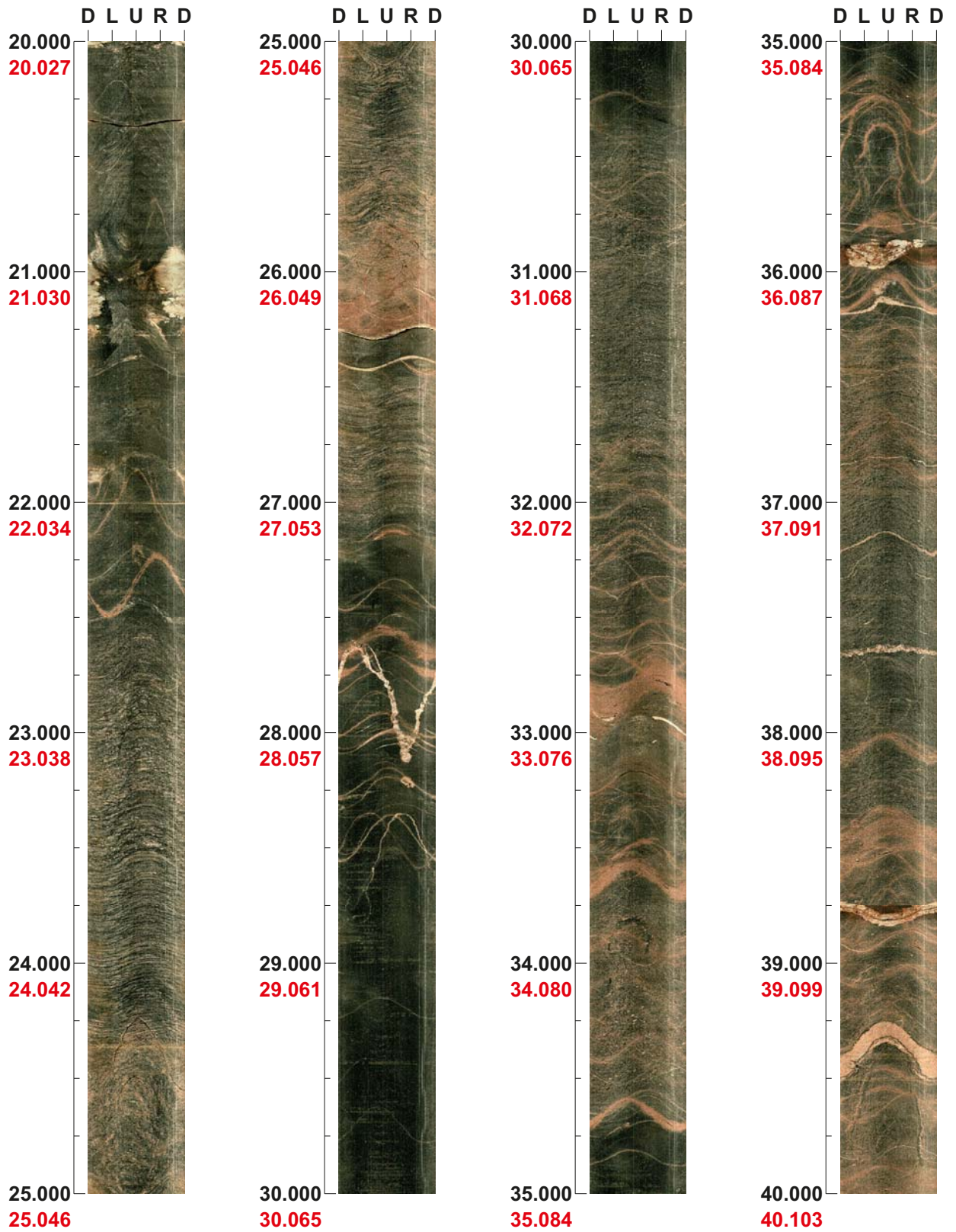

Project name: SFR
Bore hole No.: KFR103

Azimuth: 180 Inclination: -54

Depth range: 40.000 - 60.000 m

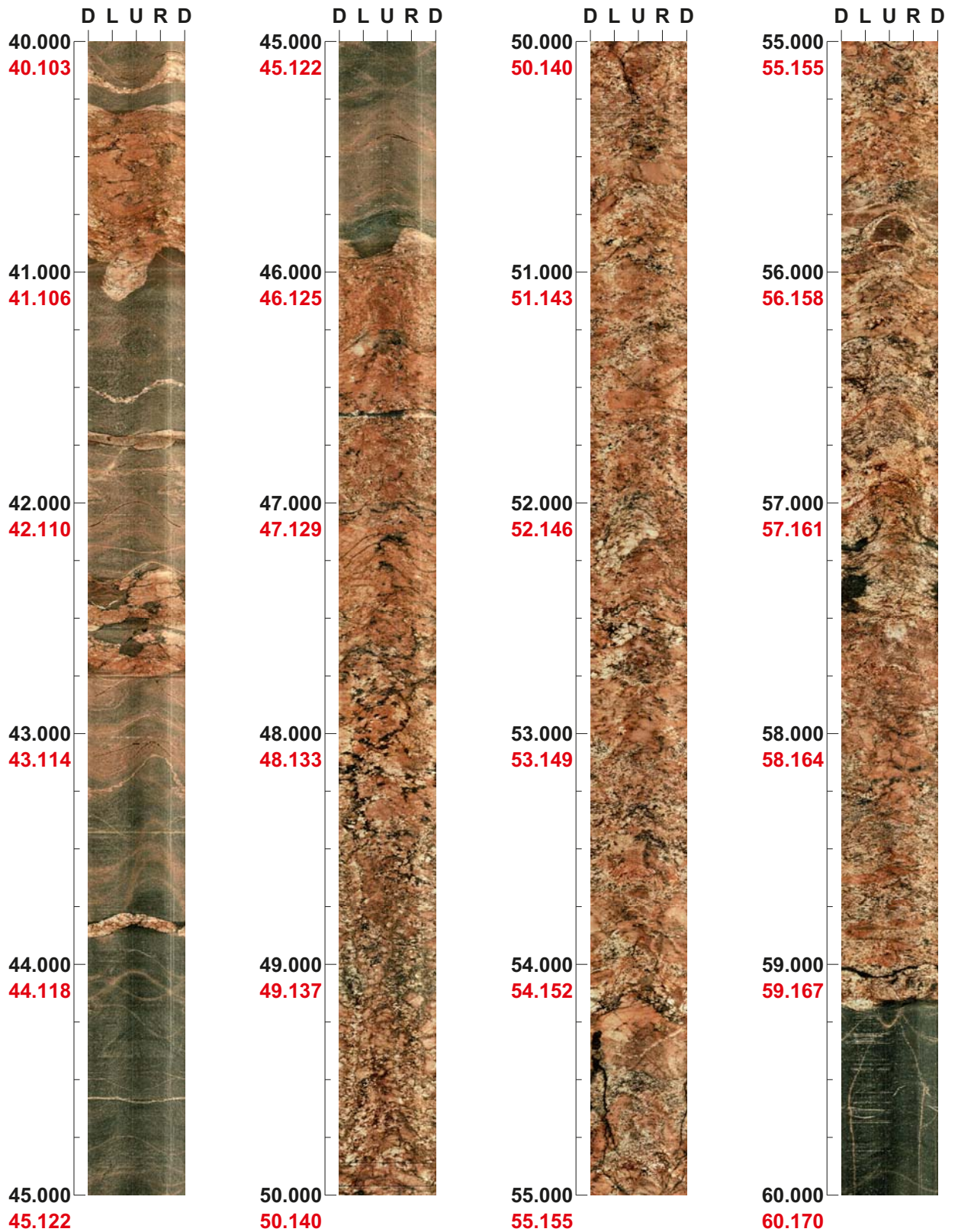

Project name: SFR
Bore hole No.: KFR103

Azimuth: 180 Inclination: -54

Depth range: 60.000 - 80.000 m

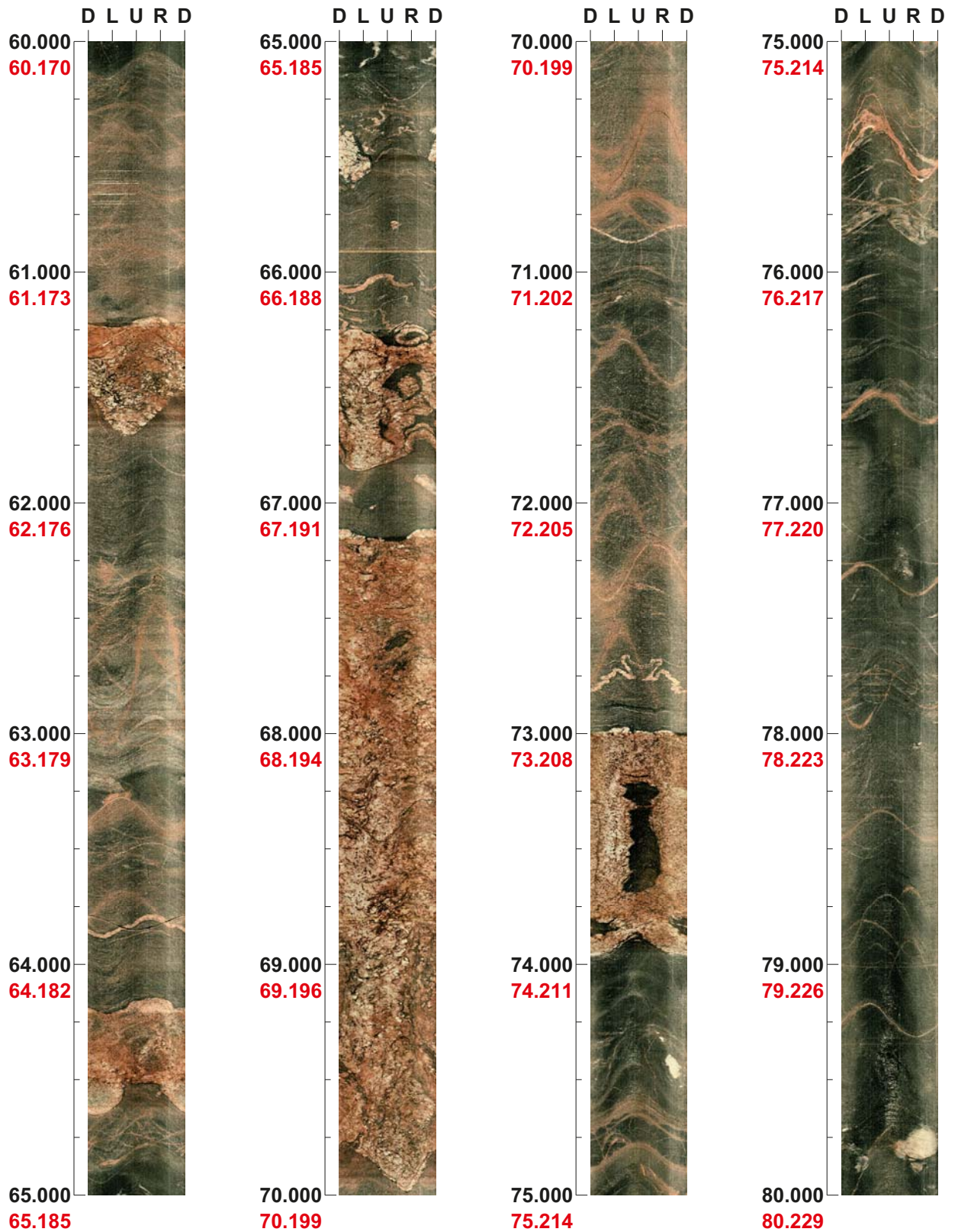

Project name: SFR
Bore hole No.: KFR103

Azimuth: 180 Inclination: -54

Depth range: 80.000 - 100.000 m

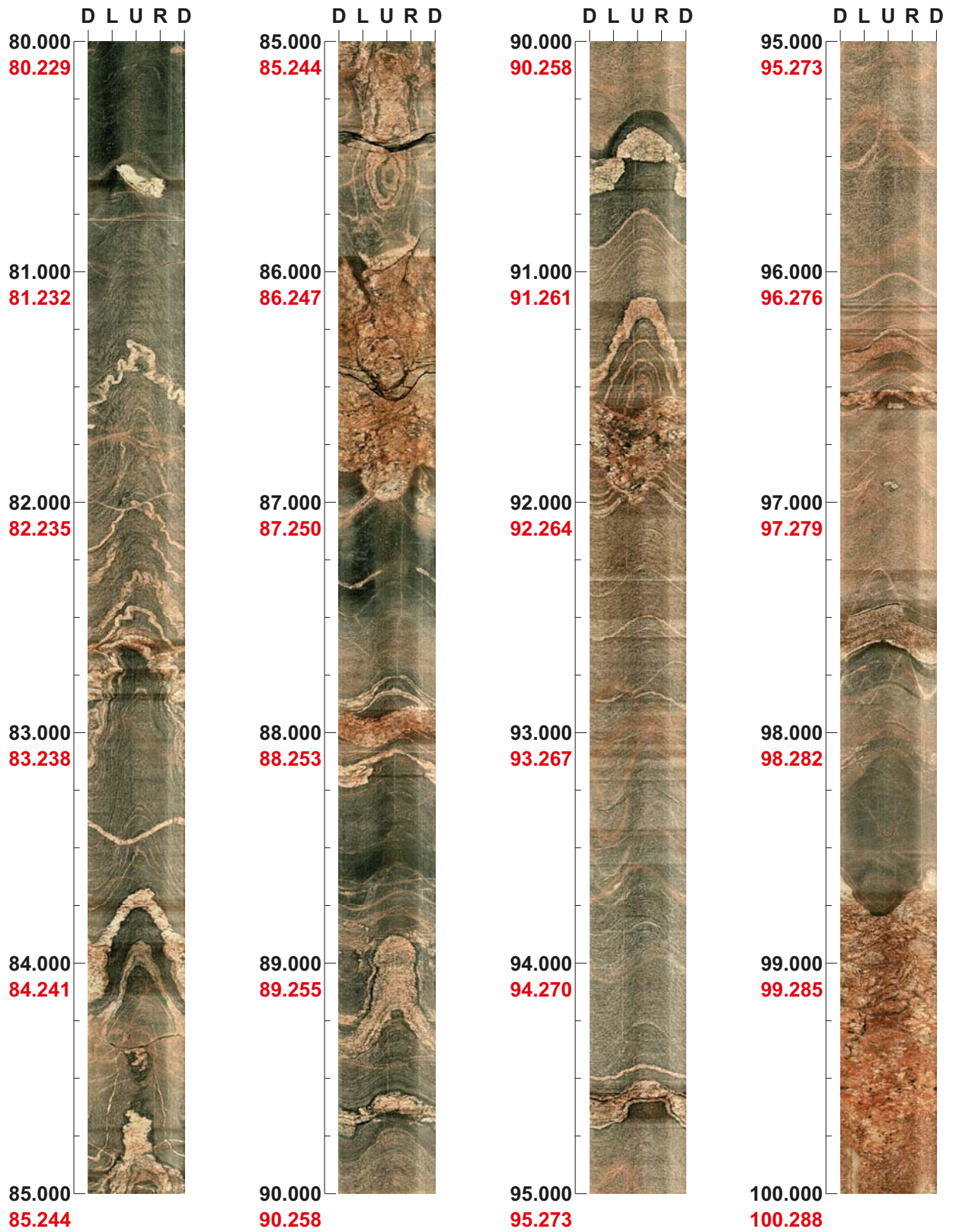

Project name: SFR
Bore hole No.: KFR103

Azimuth: 180 Inclination: -54

Depth range: 100.000 - 120.000 m

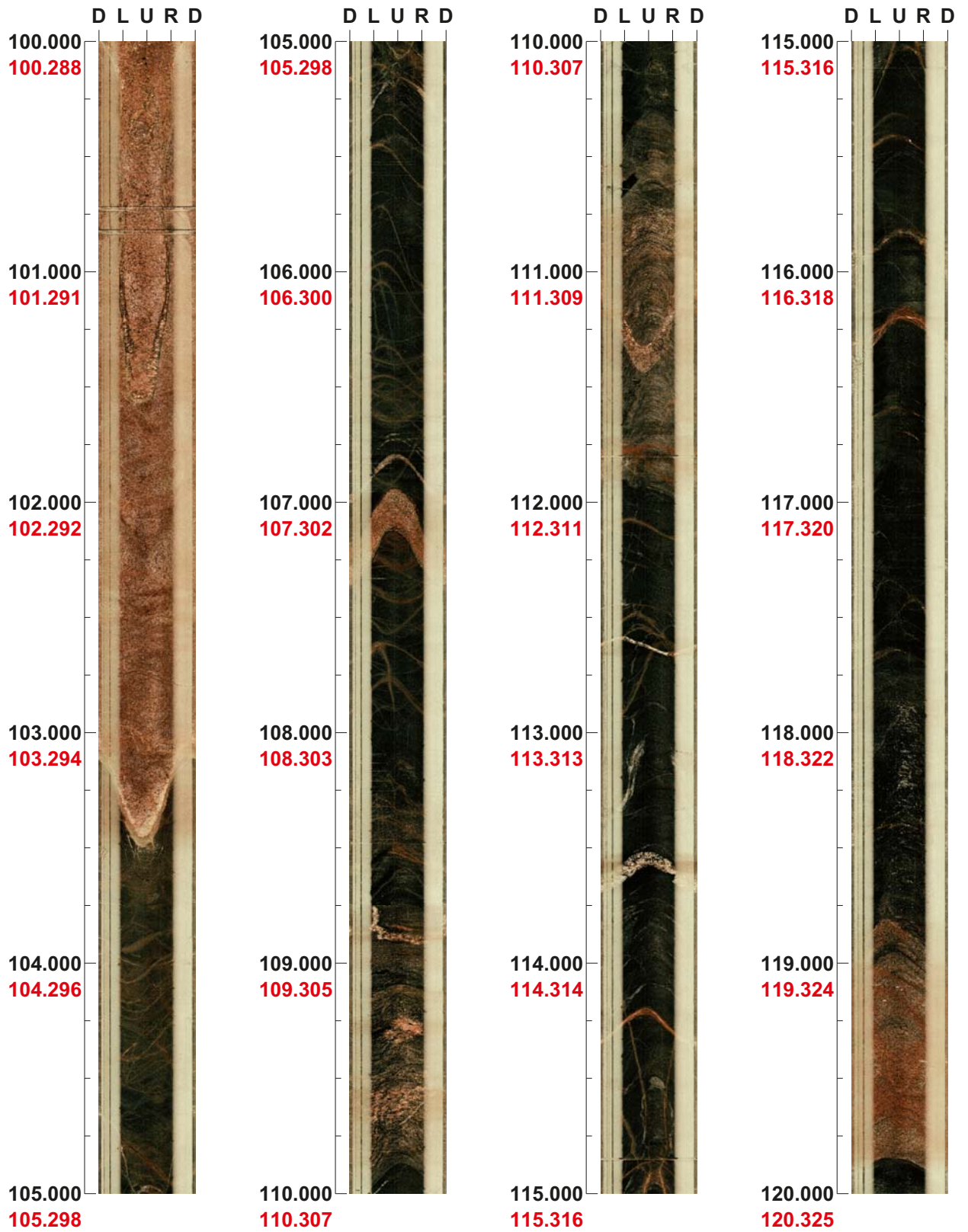

Project name: SFR
Bore hole No.: KFR103

Azimuth: 180 Inclination: -54

Depth range: 120.000 - 140.000 m

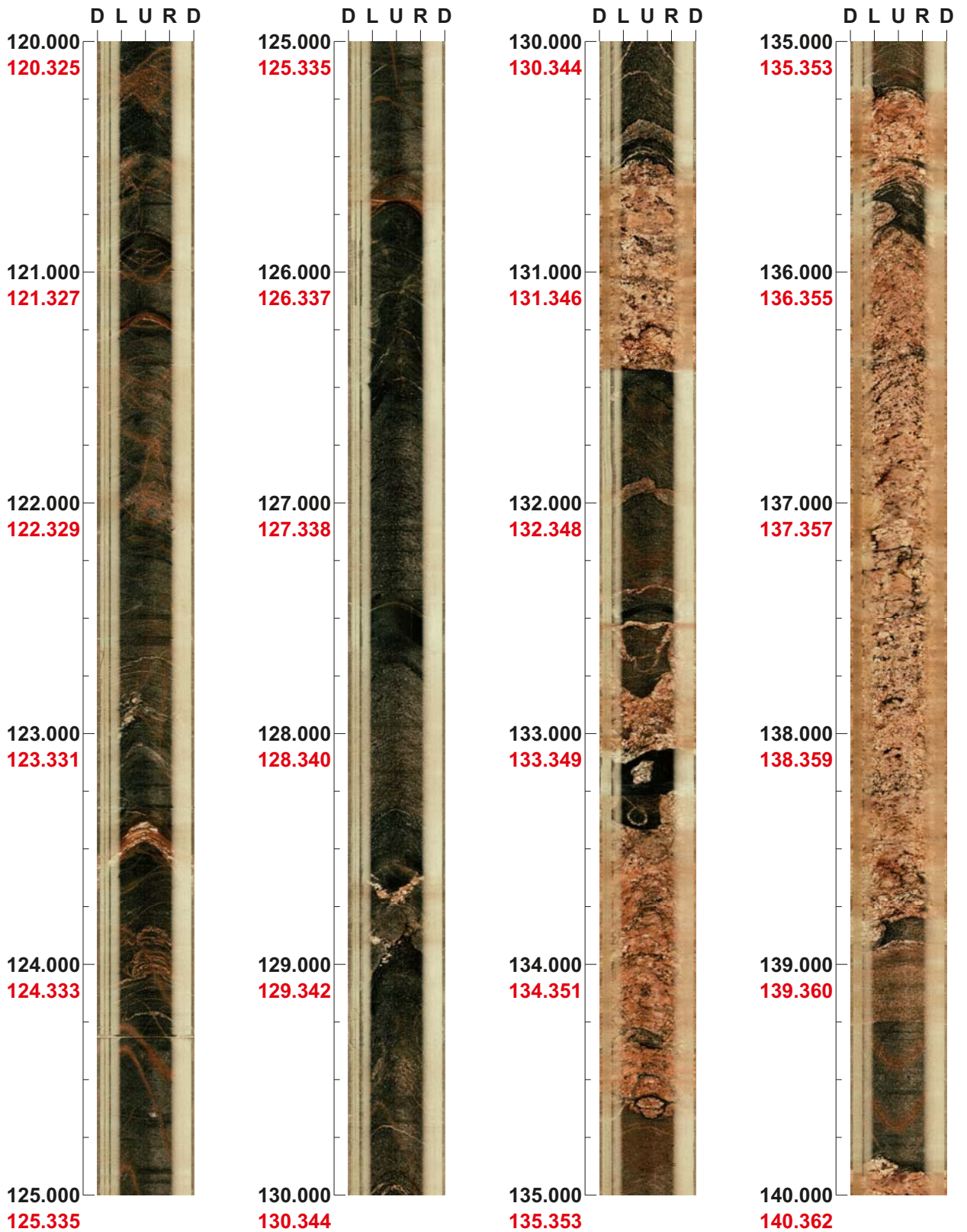

Project name: SFR
Bore hole No.: KFR103

Azimuth: 180 Inclination: -54

Depth range: 140.000 - 160.000 m

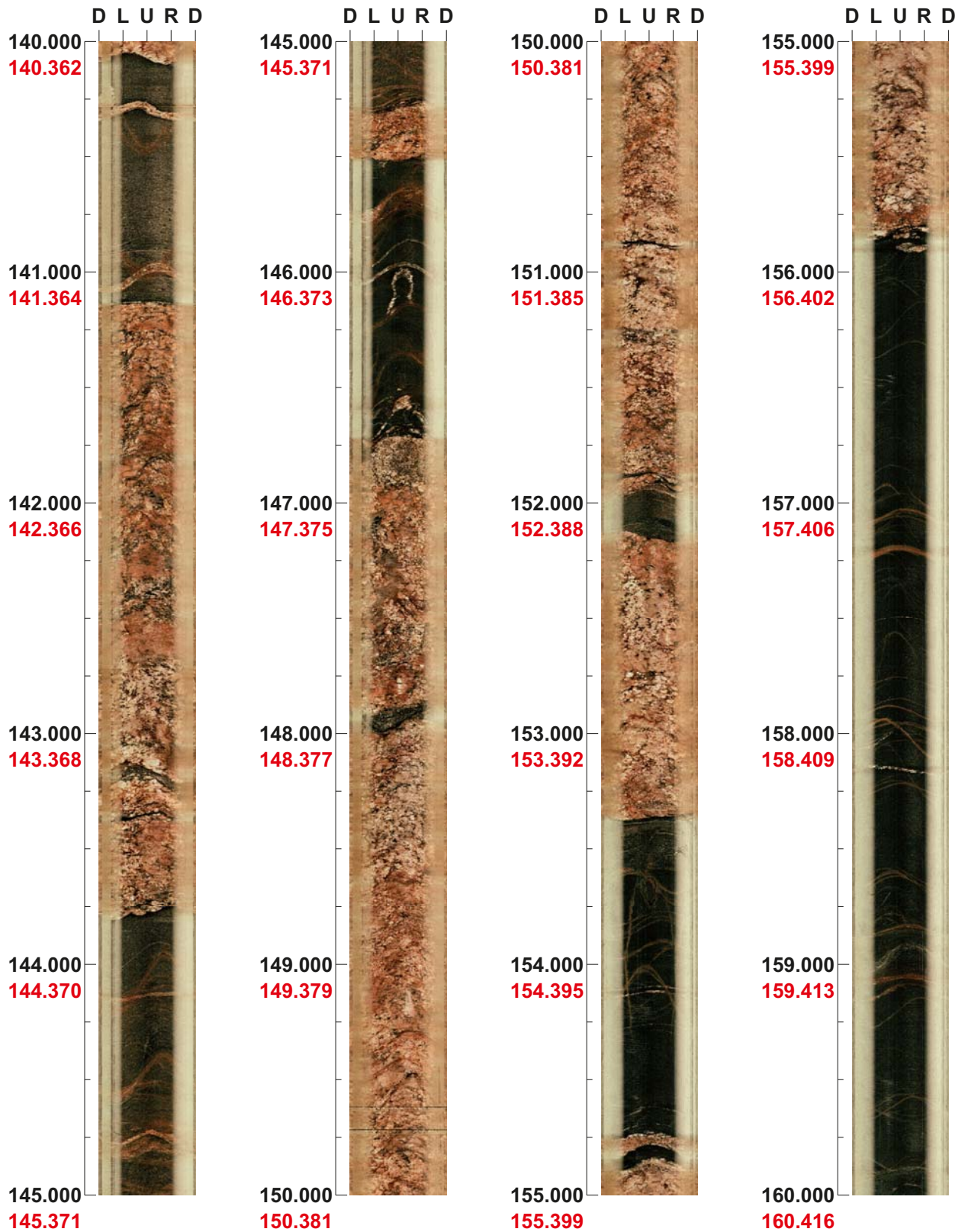

Project name: SFR
Bore hole No.: KFR103

Azimuth: 180 Inclination: -54

Depth range: 160.000 - 180.000 m



Project name: SFR
Bore hole No.: KFR103

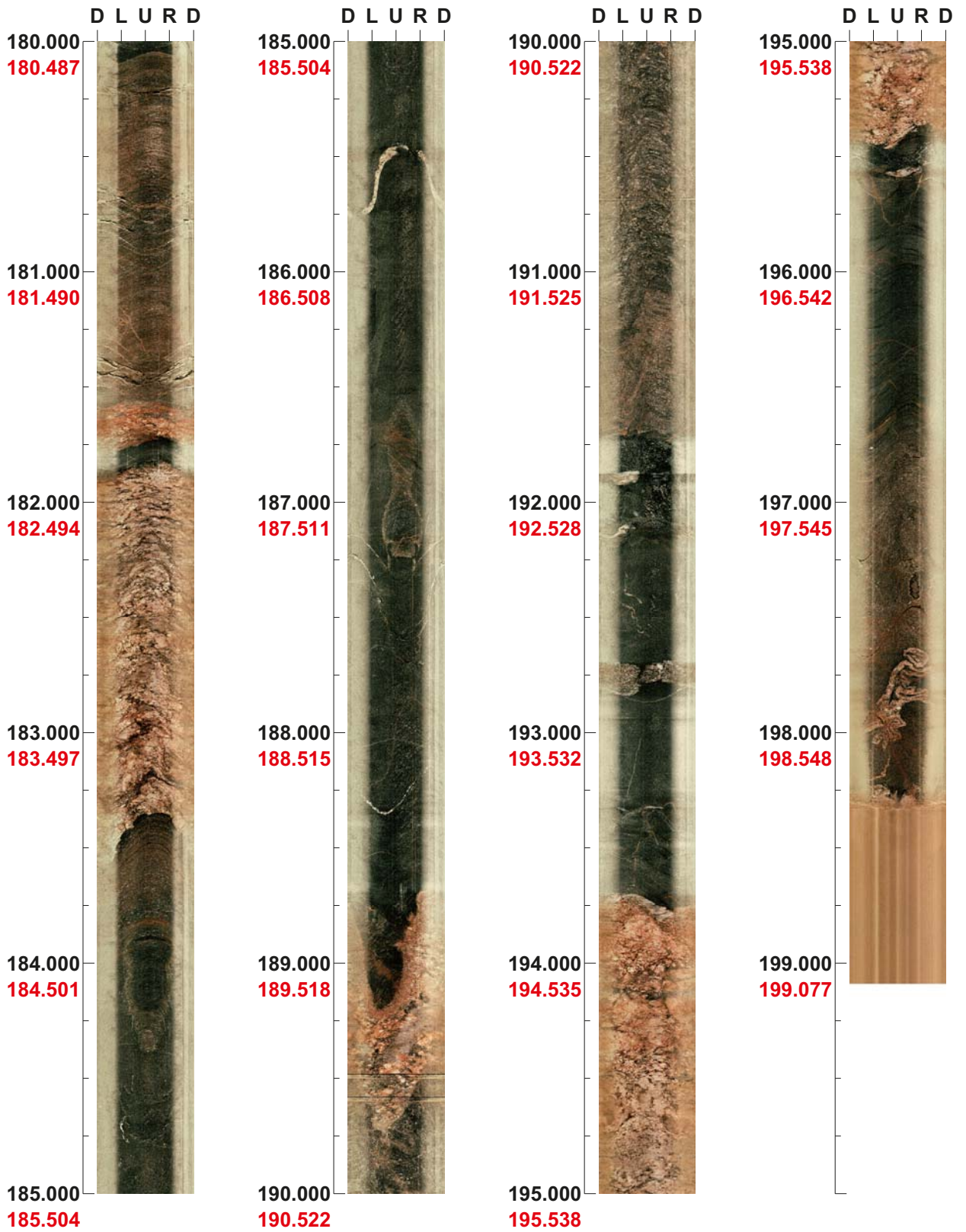

Azimuth: 180 Inclination: -54

Depth range: 180.000 - 199.089 m



Appendix 7

Project name: SFR

Image file : c:\work\r5754s~1\2008-1~1\kfr104\bips\kfr104~1.bip
BDT file : c:\work\r5754s~1\2008-1~1\kfr104\bips\kfr104~1.bdt
Locality : SFR
Bore hole number : KFR104
Date : 08/10/14
Time : 18:13:00
Depth range : 8.000 - 440.477 m
Azimuth : 134
Inclination : -54
Diameter : 76.0 mm
Magnetic declination : 0.0
Span : 4
Scan interval : 0.25
Scan direction : To bottom
Scale : 1/25
Aspect ratio : 175 %
Pages : 23
Color :  +0  +0  +0

Project name: SFR
Bore hole No.: KFR104

Azimuth: 134 Inclination: -54

Depth range: 0.000 - 20.000 m

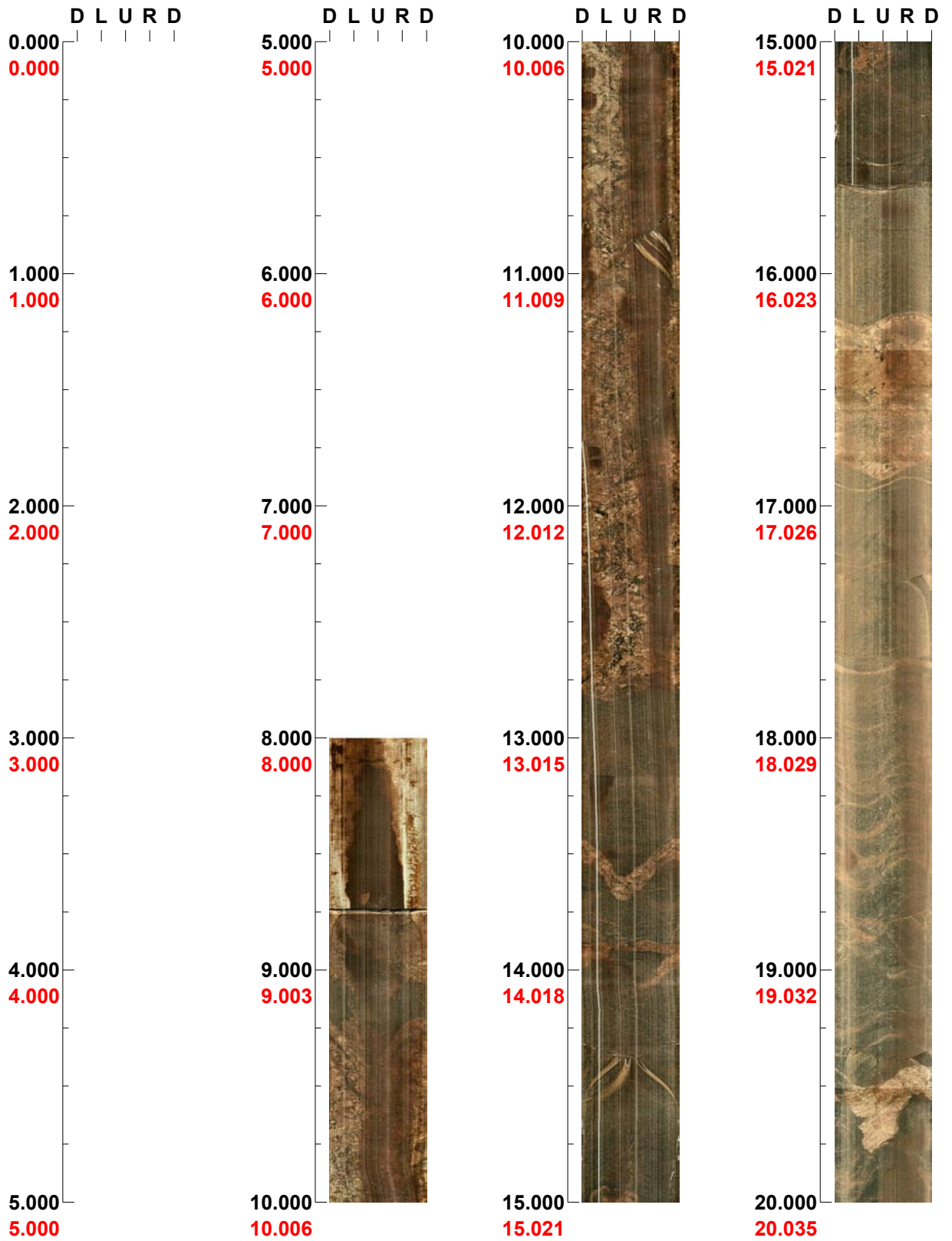

Project name: SFR
Bore hole No.: KFR104

Azimuth: 134 Inclination: -54

Depth range: 20.000 - 40.000 m

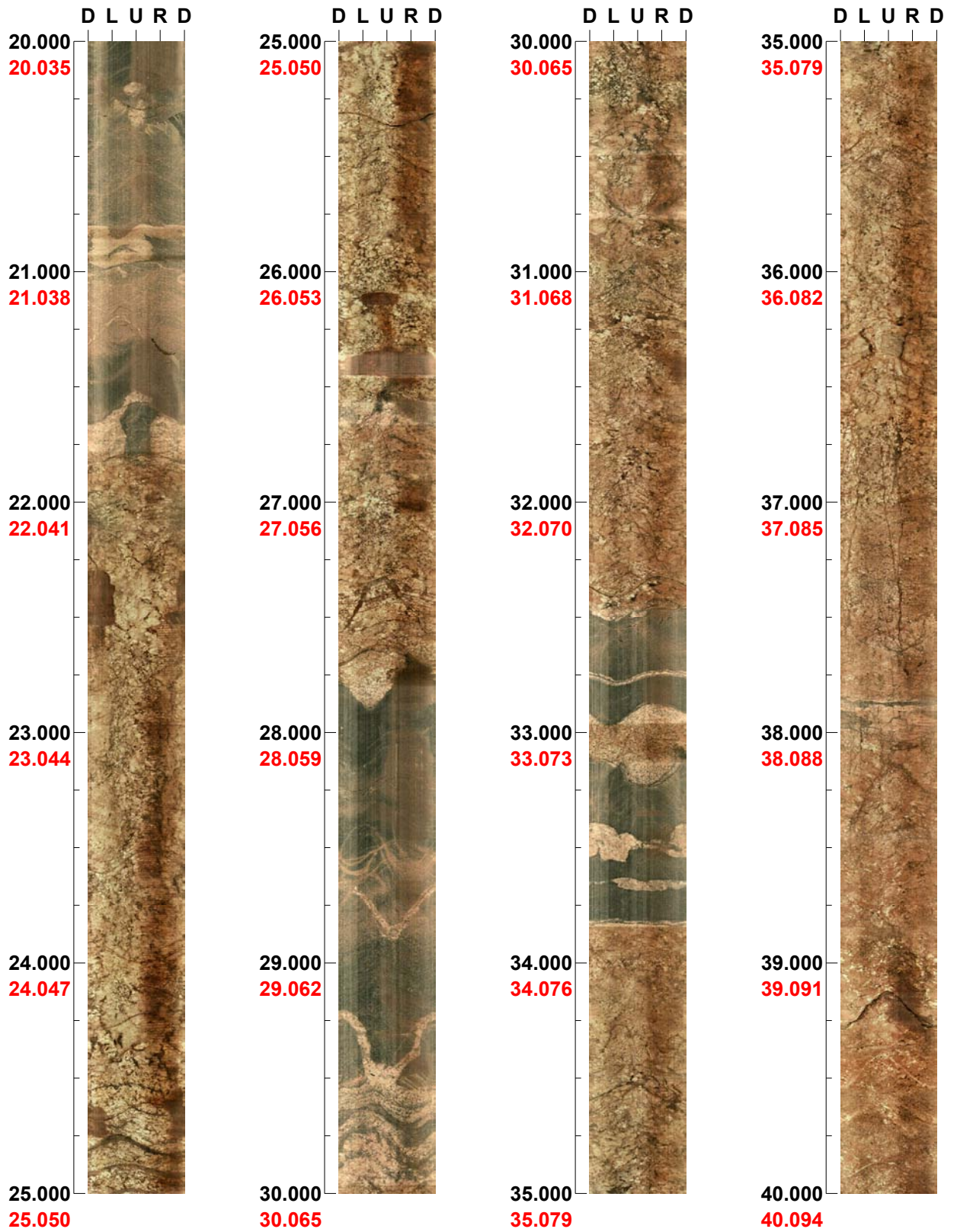

Project name: SFR
Bore hole No.: KFR104

Azimuth: 134 Inclination: -54

Depth range: 40.000 - 60.000 m

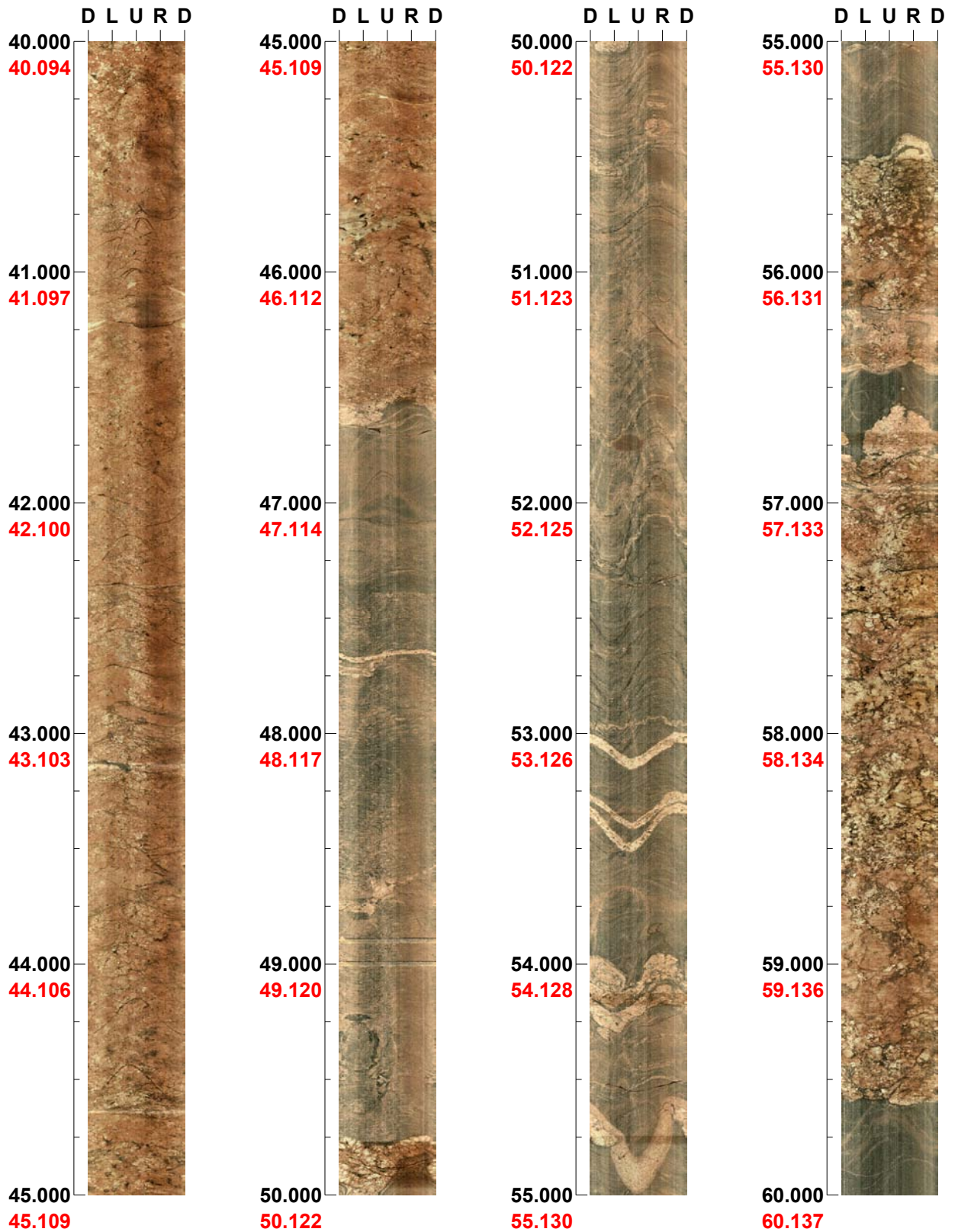

Project name: SFR
Bore hole No.: KFR104

Azimuth: 134 Inclination: -54

Depth range: 60.000 - 80.000 m

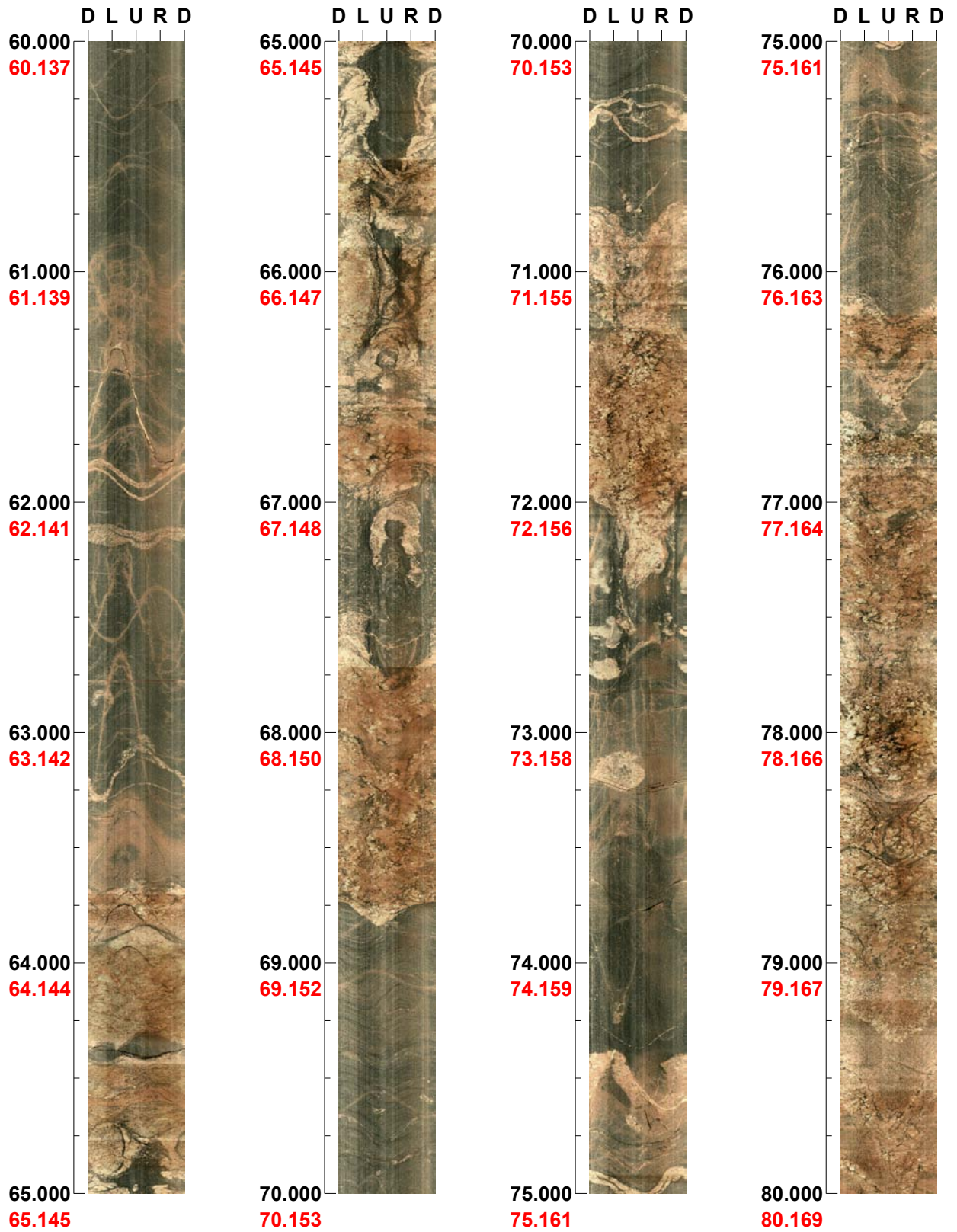

Project name: SFR
Bore hole No.: KFR104

Azimuth: 134 Inclination: -54

Depth range: 80.000 - 100.000 m

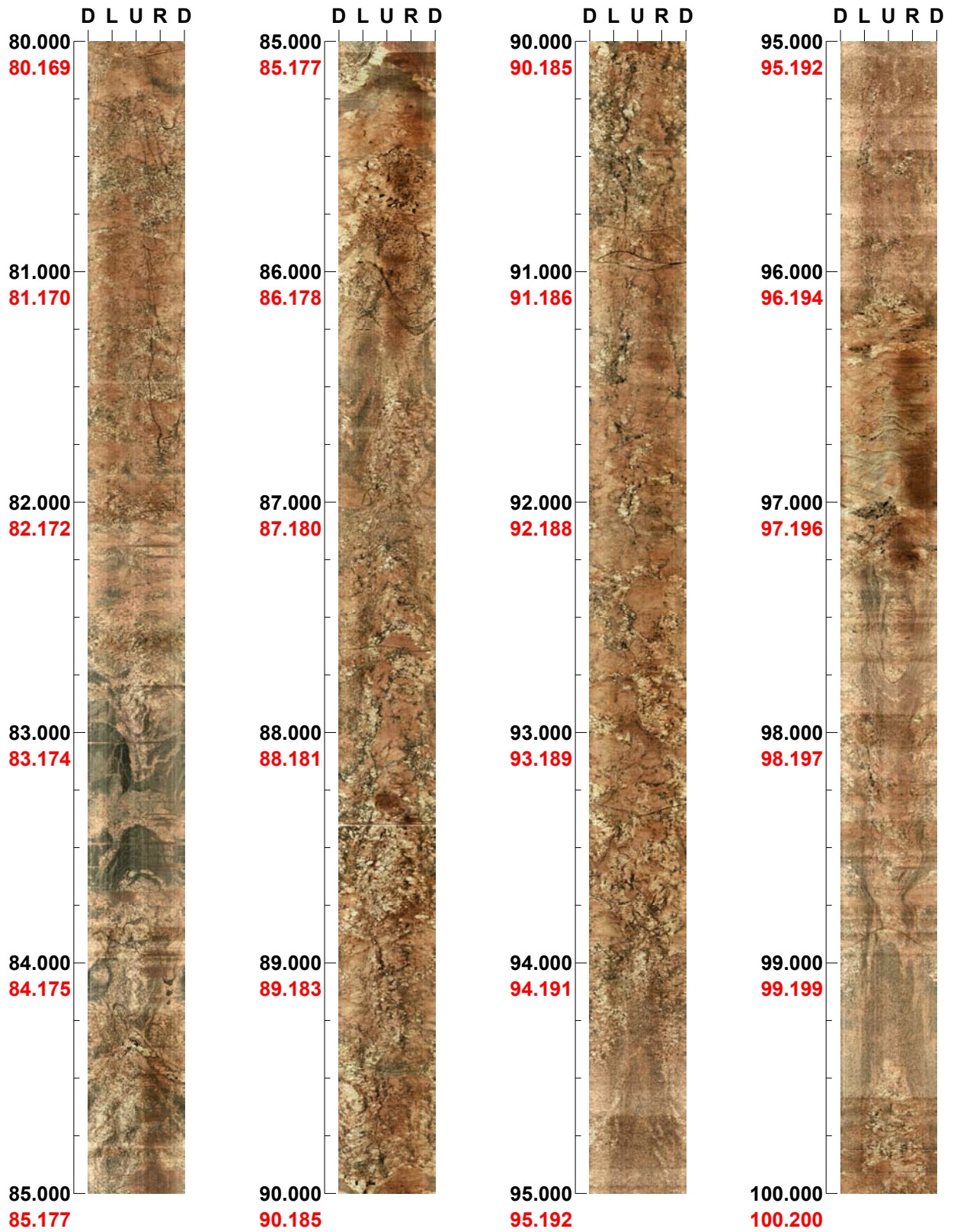

Project name: SFR
Bore hole No.: KFR104

Azimuth: 134 Inclination: -54

Depth range: 100.000 - 120.000 m

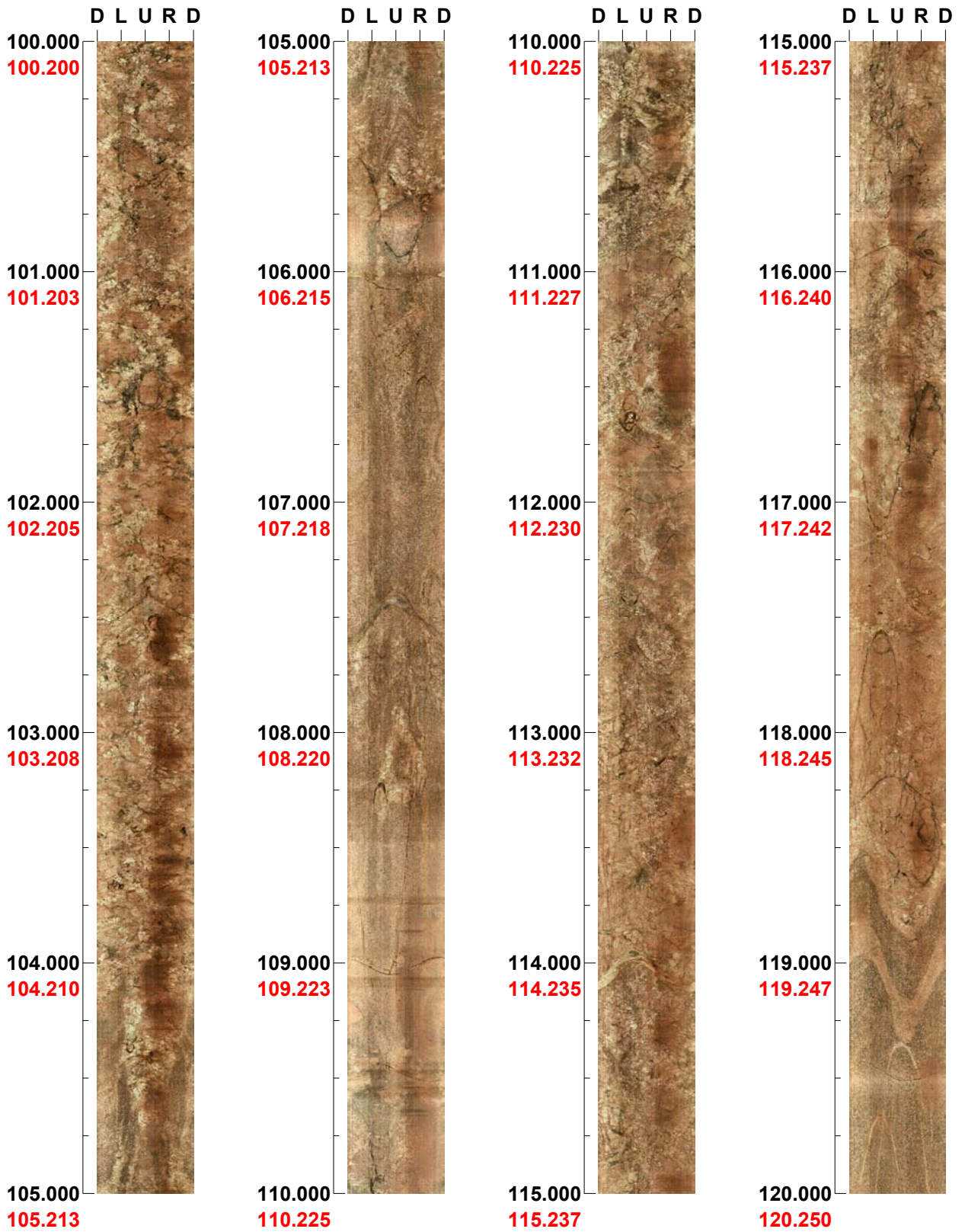

Project name: SFR
Bore hole No.: KFR104

Azimuth: 134 Inclination: -54

Depth range: 120.000 - 140.000 m

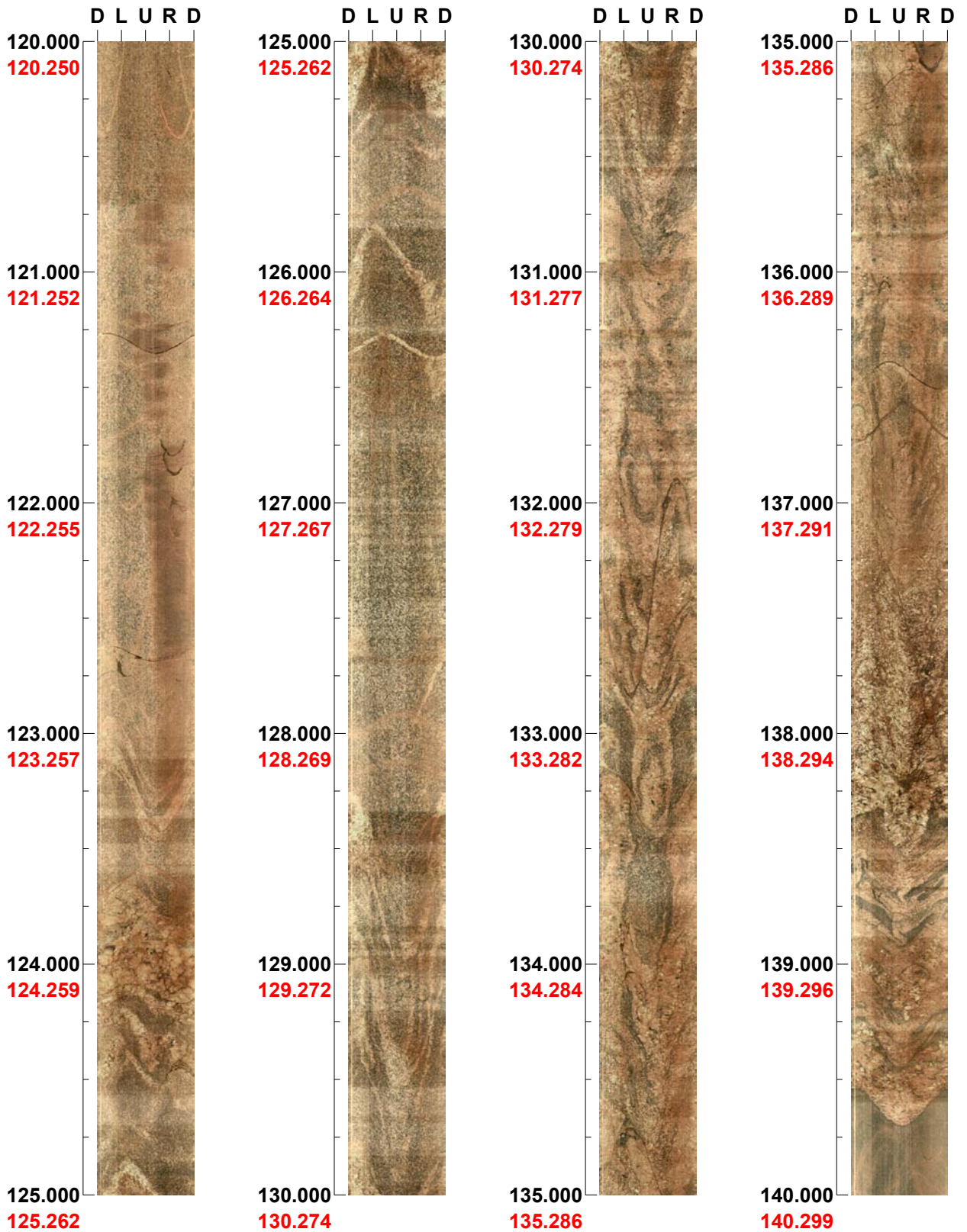

Project name: SFR
Bore hole No.: KFR104

Azimuth: 134 Inclination: -54

Depth range: 140.000 - 160.000 m

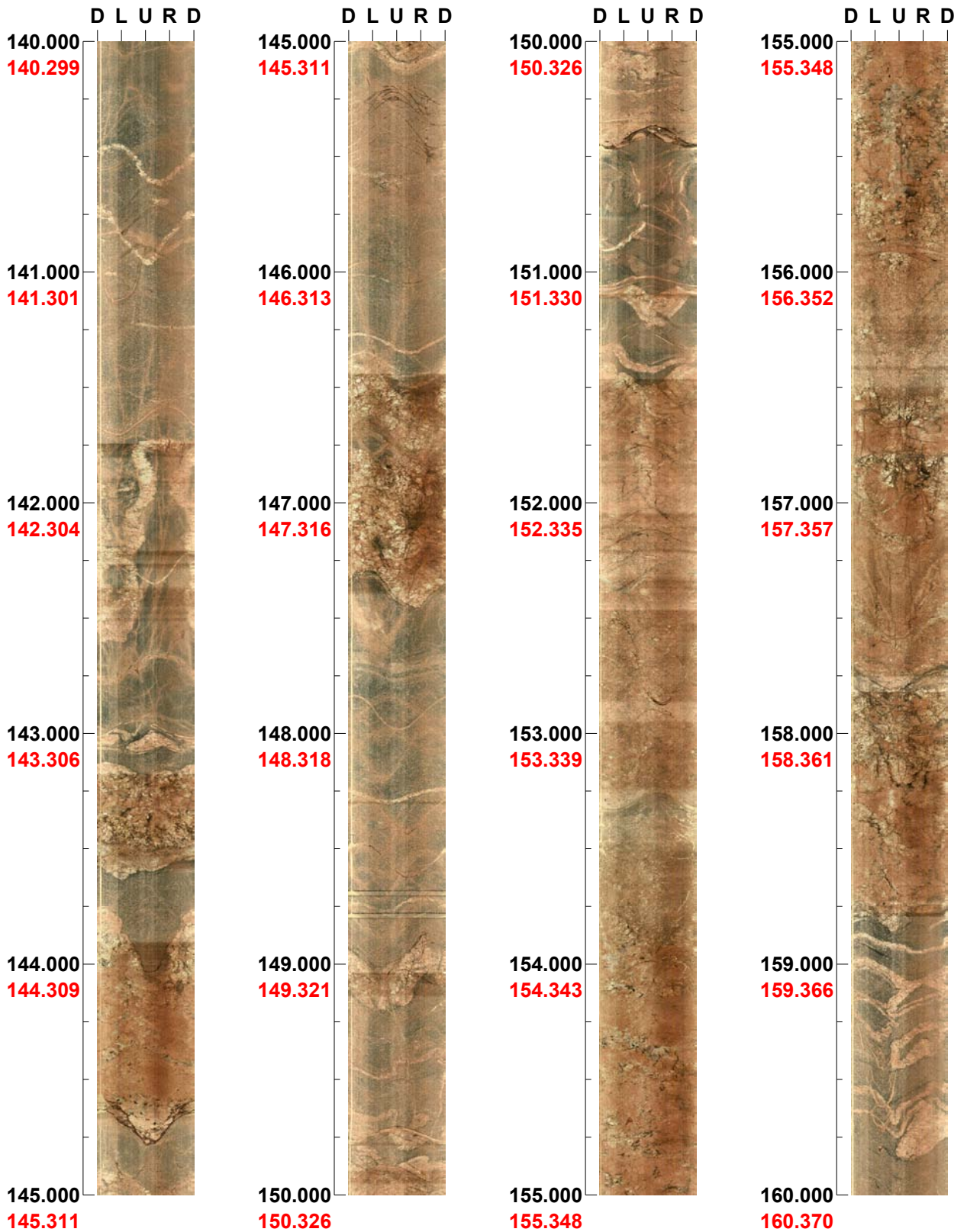

Project name: SFR
Bore hole No.: KFR104

Azimuth: 134 Inclination: -54

Depth range: 160.000 - 180.000 m

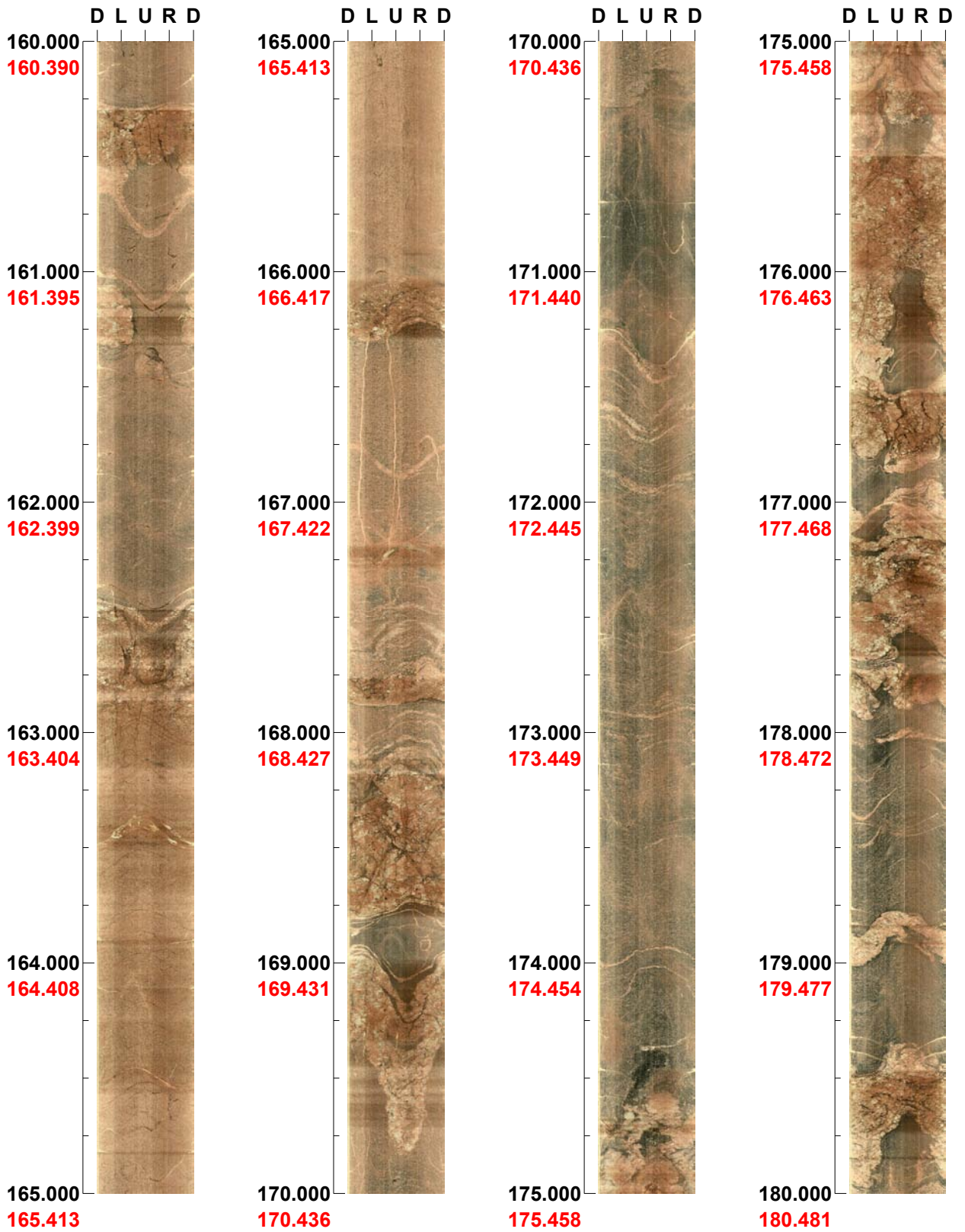

Project name: SFR
Bore hole No.: KFR104

Azimuth: 134 Inclination: -54

Depth range: 180.000 - 200.000 m

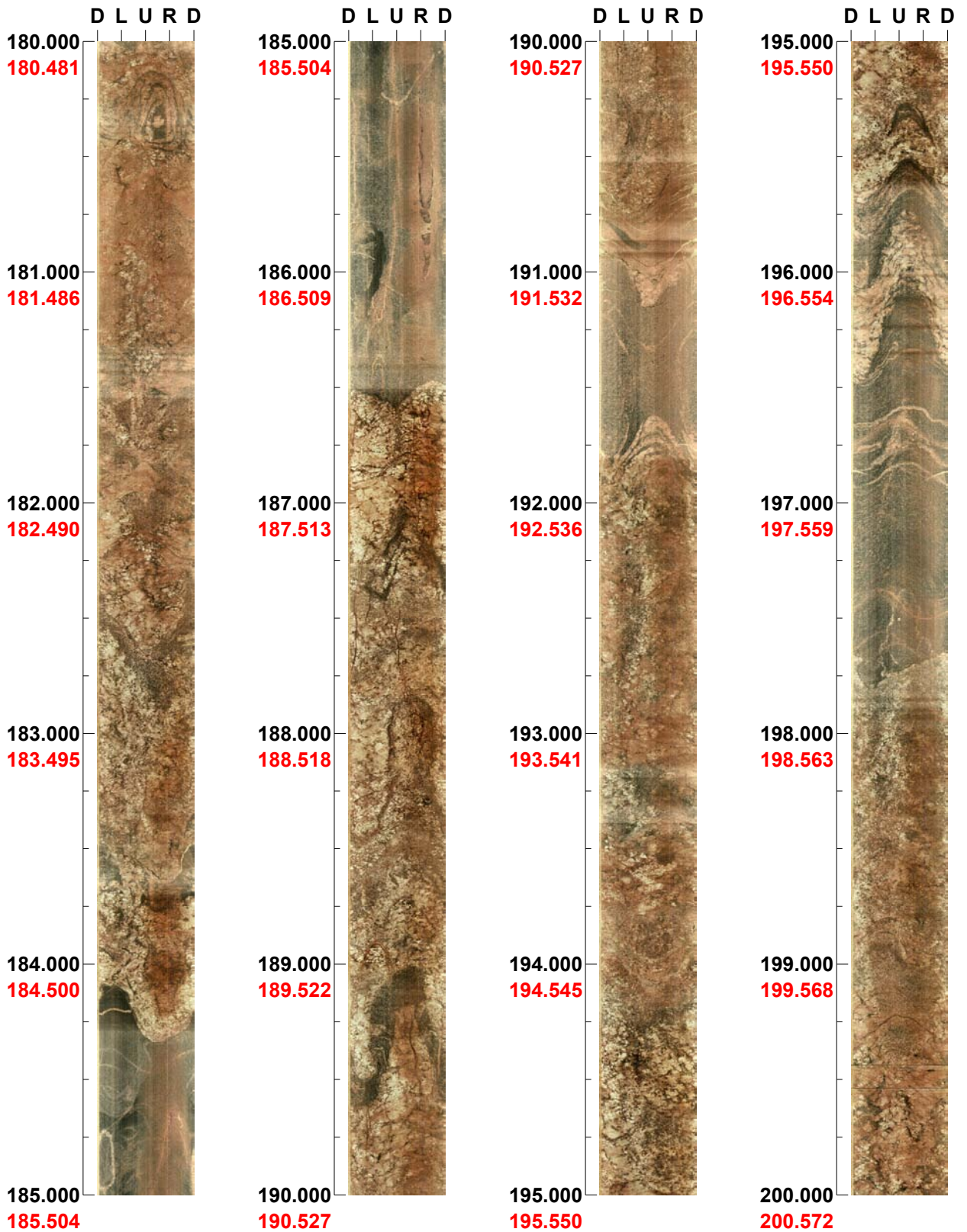

Project name: SFR
Bore hole No.: KFR104

Azimuth: 134 Inclination: -54

Depth range: 200.000 - 220.000 m



Project name: SFR
Bore hole No.: KFR104

Azimuth: 134 Inclination: -54

Depth range: 220.000 - 240.000 m

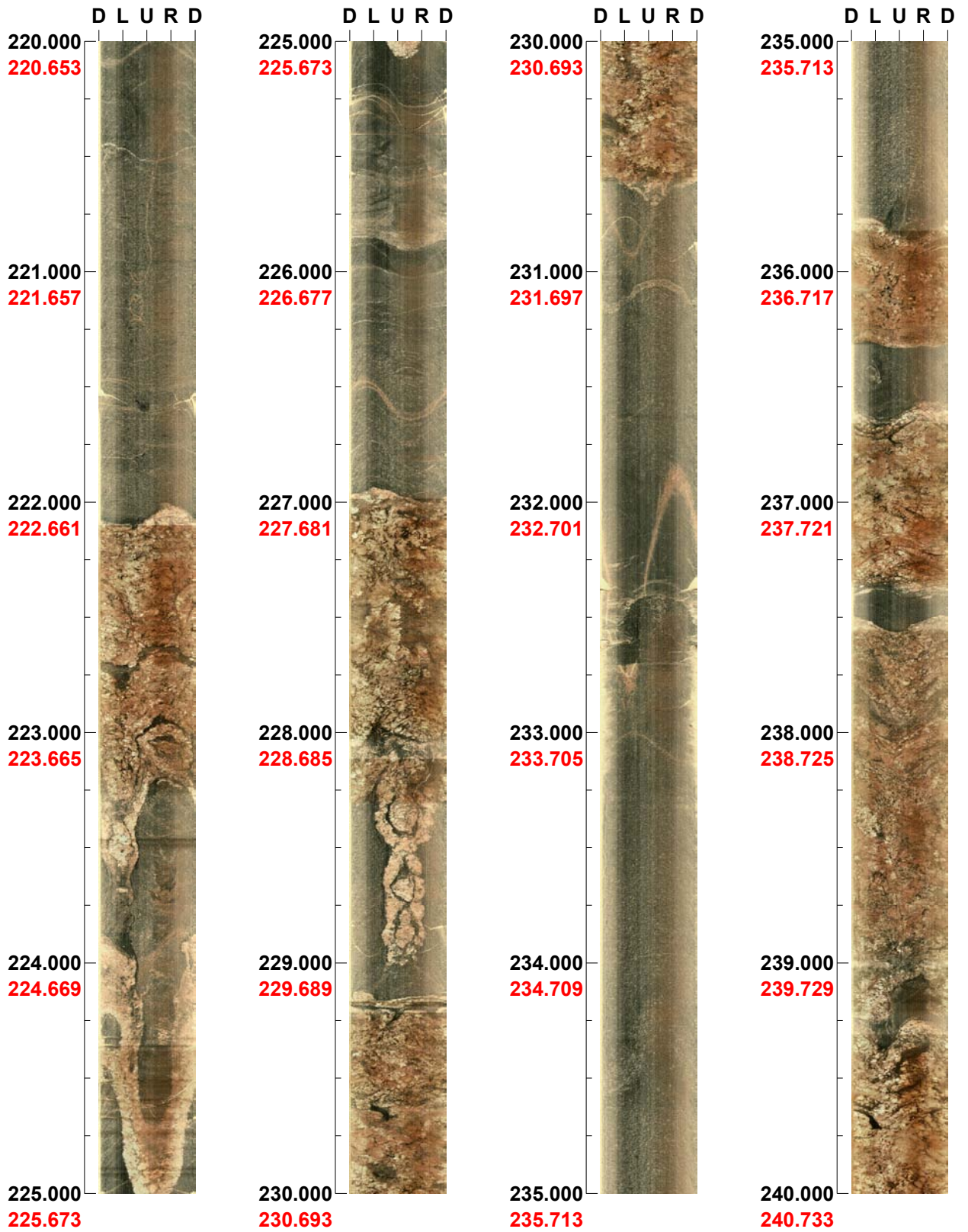

Project name: SFR
Bore hole No.: KFR104

Azimuth: 134 Inclination: -54

Depth range: 240.000 - 260.000 m

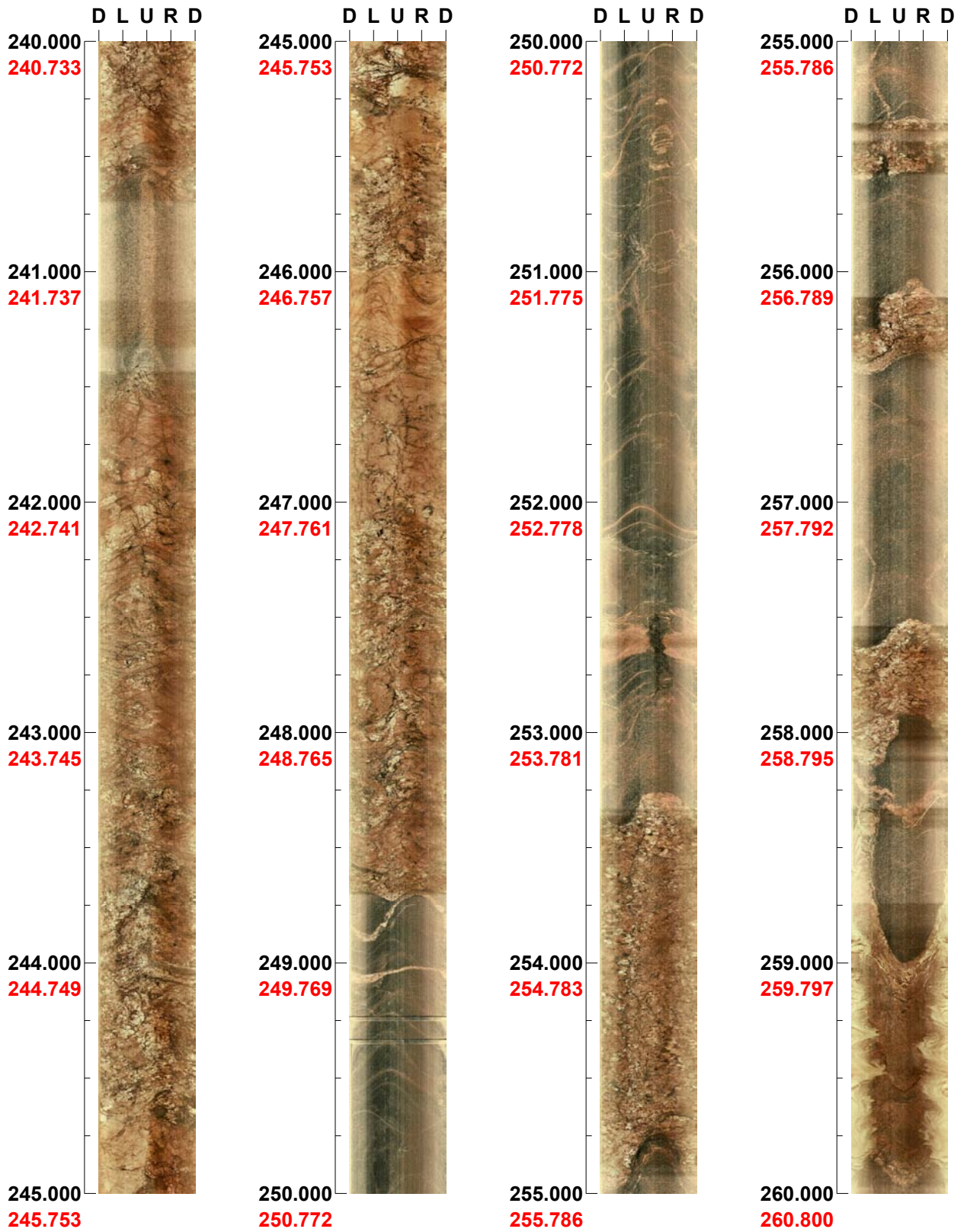

Project name: SFR
Bore hole No.: KFR104

Azimuth: 134 Inclination: -54

Depth range: 260.000 - 280.000 m



Project name: SFR
Bore hole No.: KFR104

Azimuth: 134 Inclination: -54

Depth range: 280.000 - 300.000 m



Project name: SFR
Bore hole No.: KFR104

Azimuth: 134 Inclination: -54

Depth range: 300.000 - 320.000 m

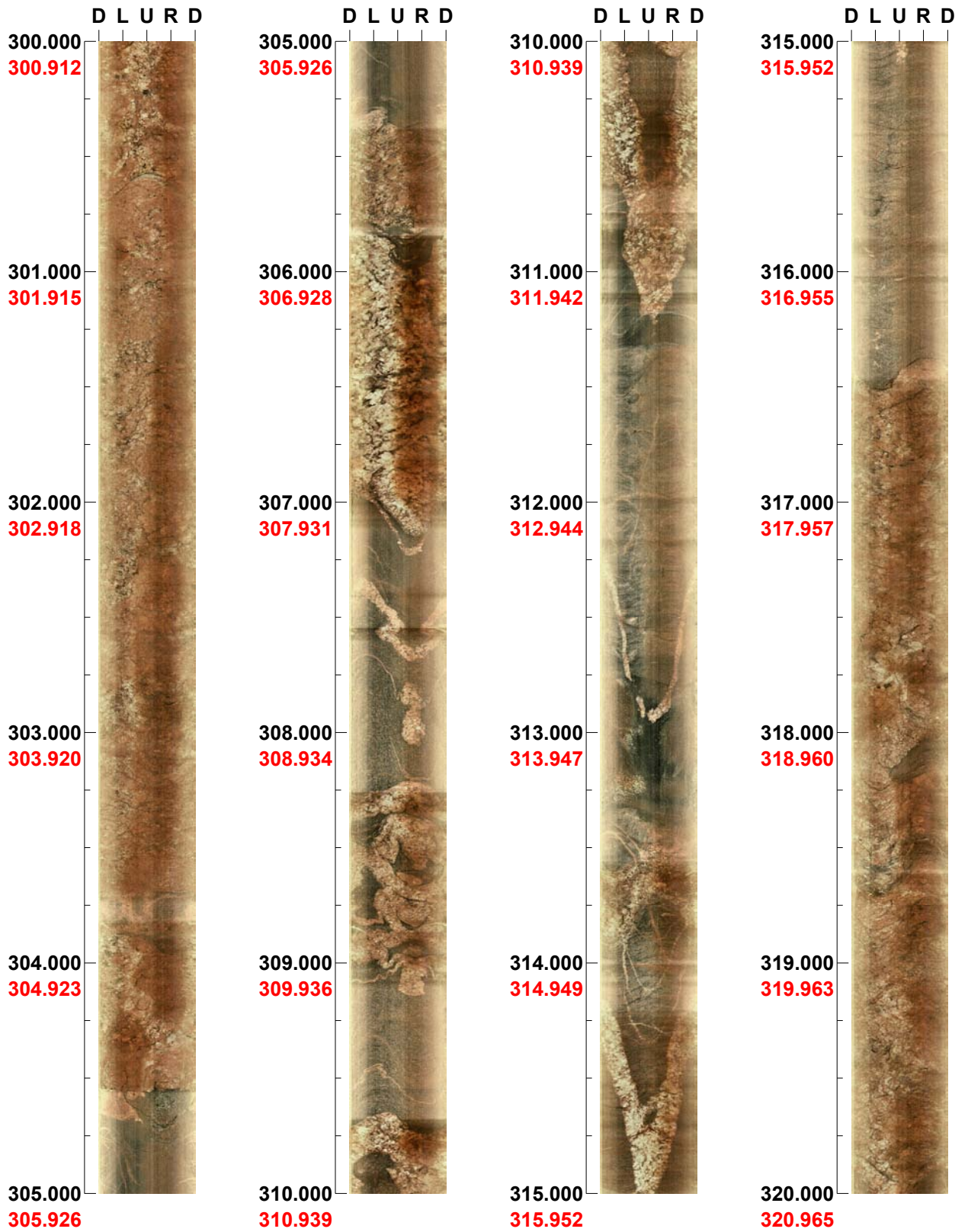

Project name: SFR
Bore hole No.: KFR104

Azimuth: 134 Inclination: -54

Depth range: 320.000 - 340.000 m



Project name: SFR
Bore hole No.: KFR104

Azimuth: 134 Inclination: -54

Depth range: 340.000 - 360.000 m



Project name: SFR
Bore hole No.: KFR104

Azimuth: 134 Inclination: -54

Depth range: 360.000 - 380.000 m



Project name: SFR
Bore hole No.: KFR104

Azimuth: 134 Inclination: -54

Depth range: 380.000 - 400.000 m

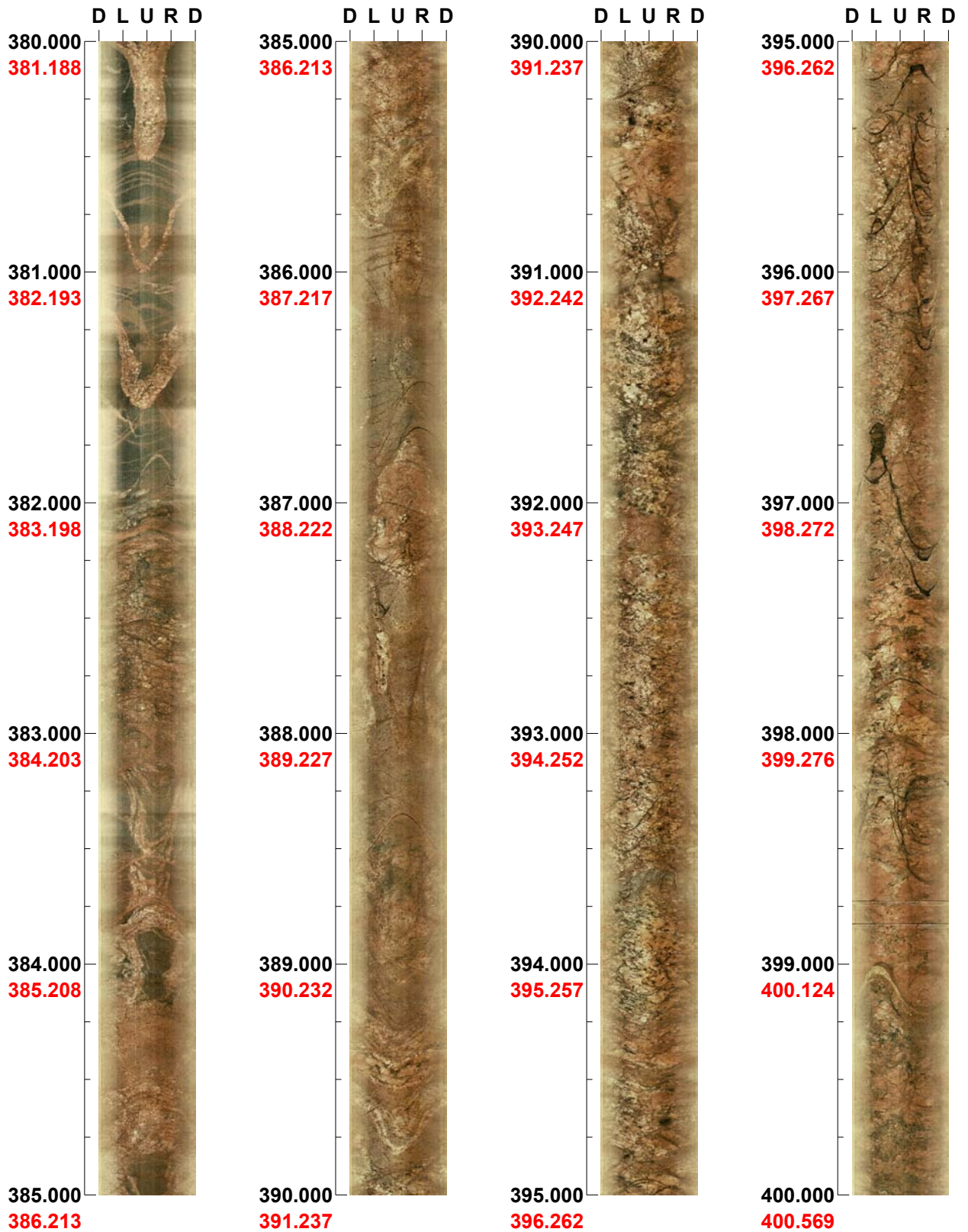

Project name: SFR
Bore hole No.: KFR104

Azimuth: 134 Inclination: -54

Depth range: 400.000 - 420.000 m



Project name: SFR
Bore hole No.: KFR104

Azimuth: 134 Inclination: -54

Depth range: 420.000 - 440.000 m



Project name: SFR
Bore hole No.: KFR104

Azimuth: 134 Inclination: -54

Depth range: 440.000 - 440.477 m

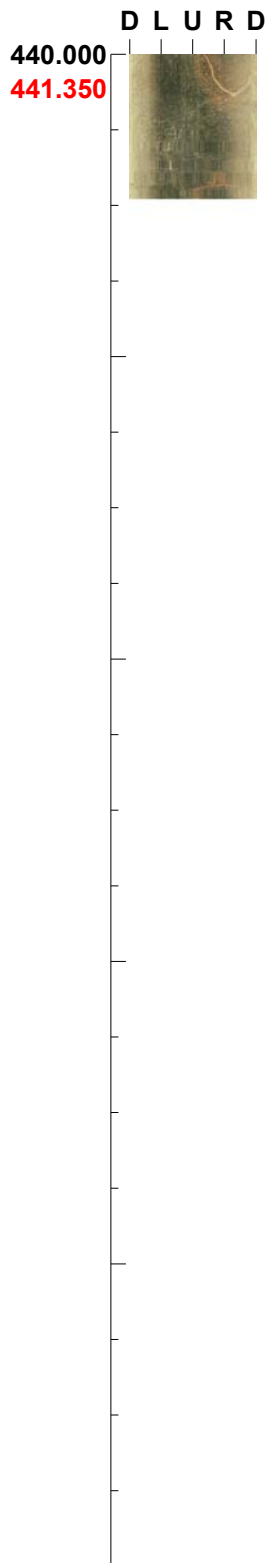

Project name: SFR
Bore hole No.: KFR27

Azimuth: 0

Inclination: -90

Depth range: 140.000 - 160.000 m

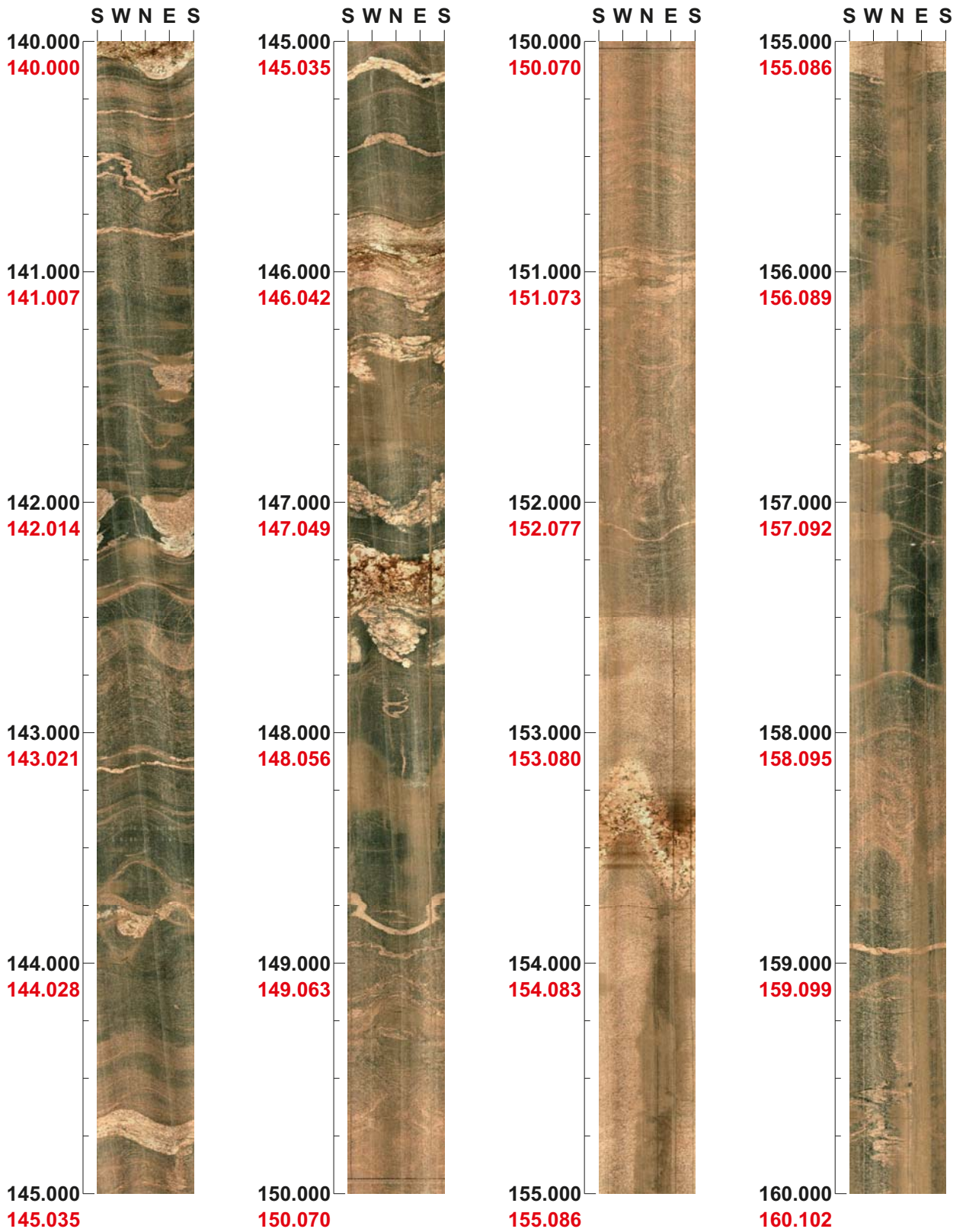

Project name: SFR
Bore hole No.: KFR27

Azimuth: 0

Inclination: -90

Depth range: 160.000 - 180.000 m

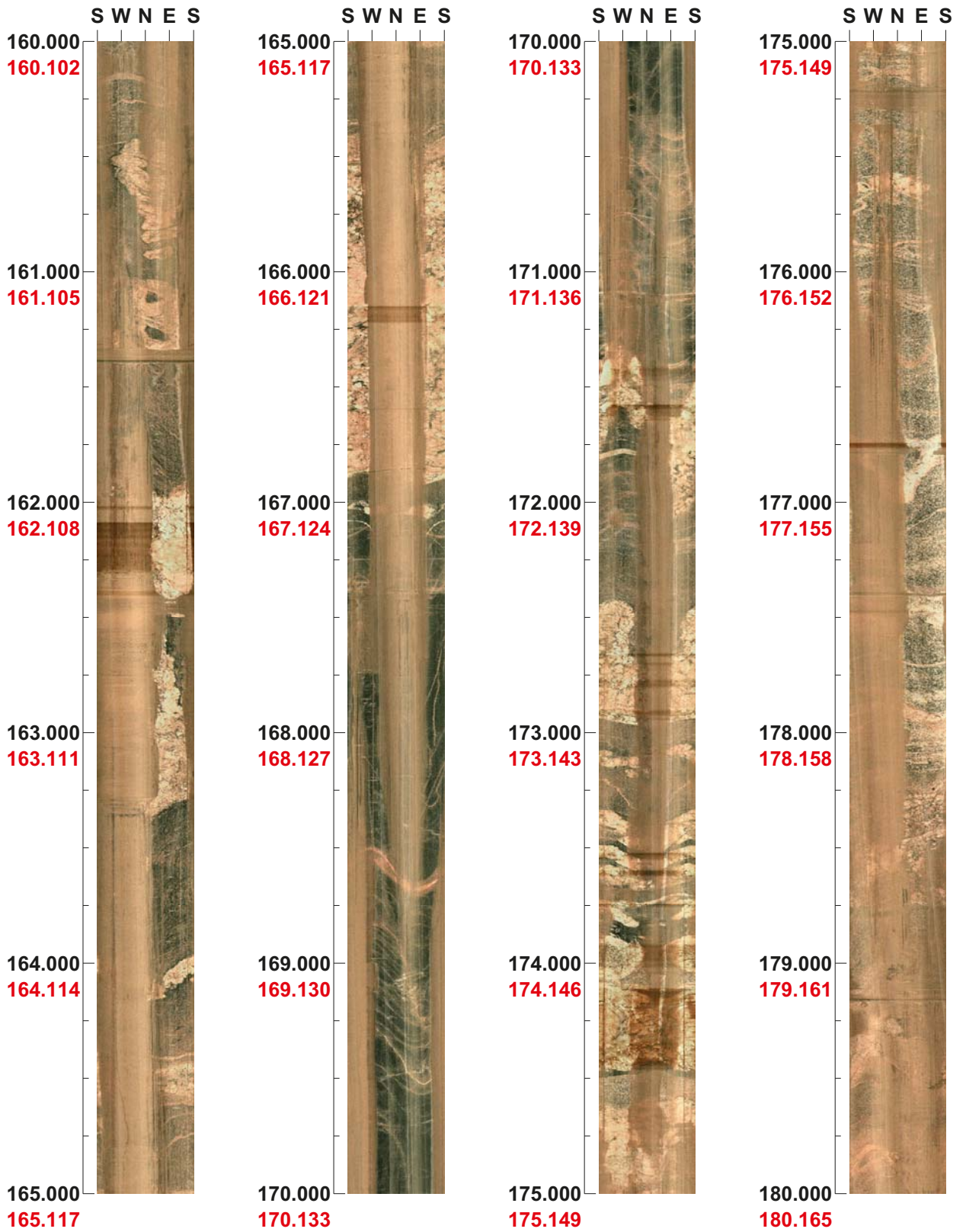

Project name: SFR
Bore hole No.: KFR27

Azimuth: 0

Inclination: -90

Depth range: 180.000 - 200.000 m

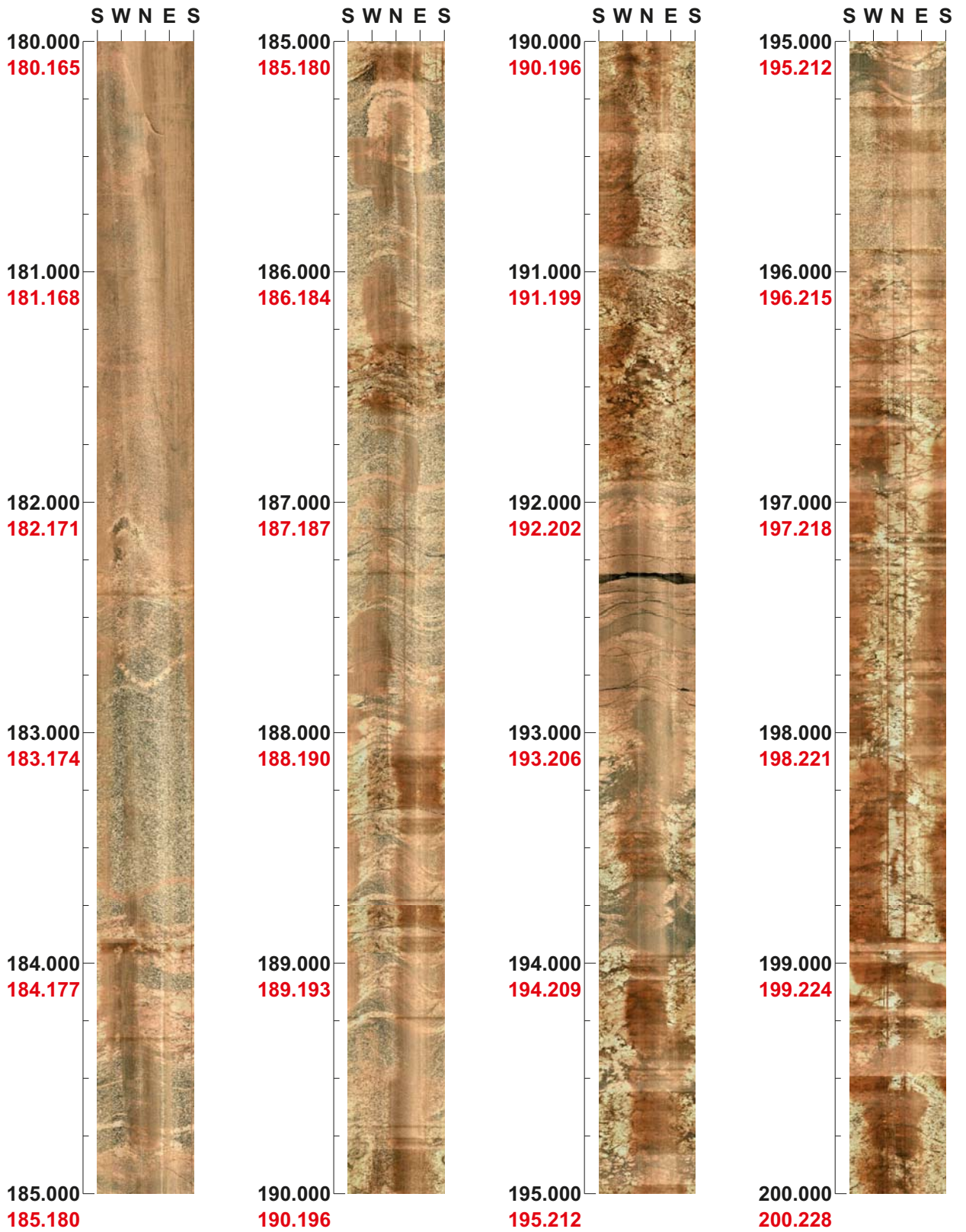

Project name: SFR
Bore hole No.: KFR27

Azimuth: 0

Inclination: -90

Depth range: 200.000 - 220.000 m

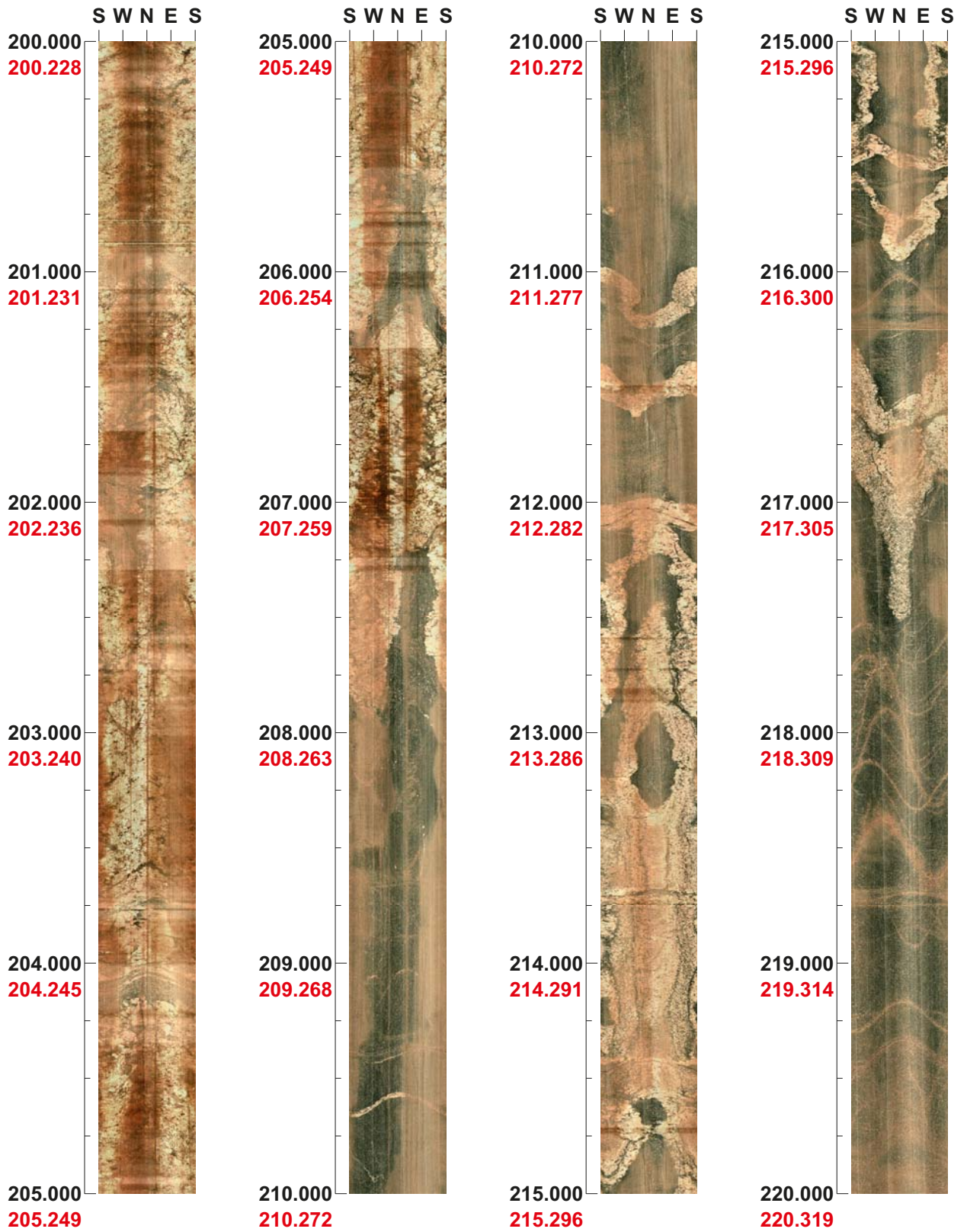

Project name: SFR
Bore hole No.: KFR27

Azimuth: 0

Inclination: -90

Depth range: 220.000 - 240.000 m

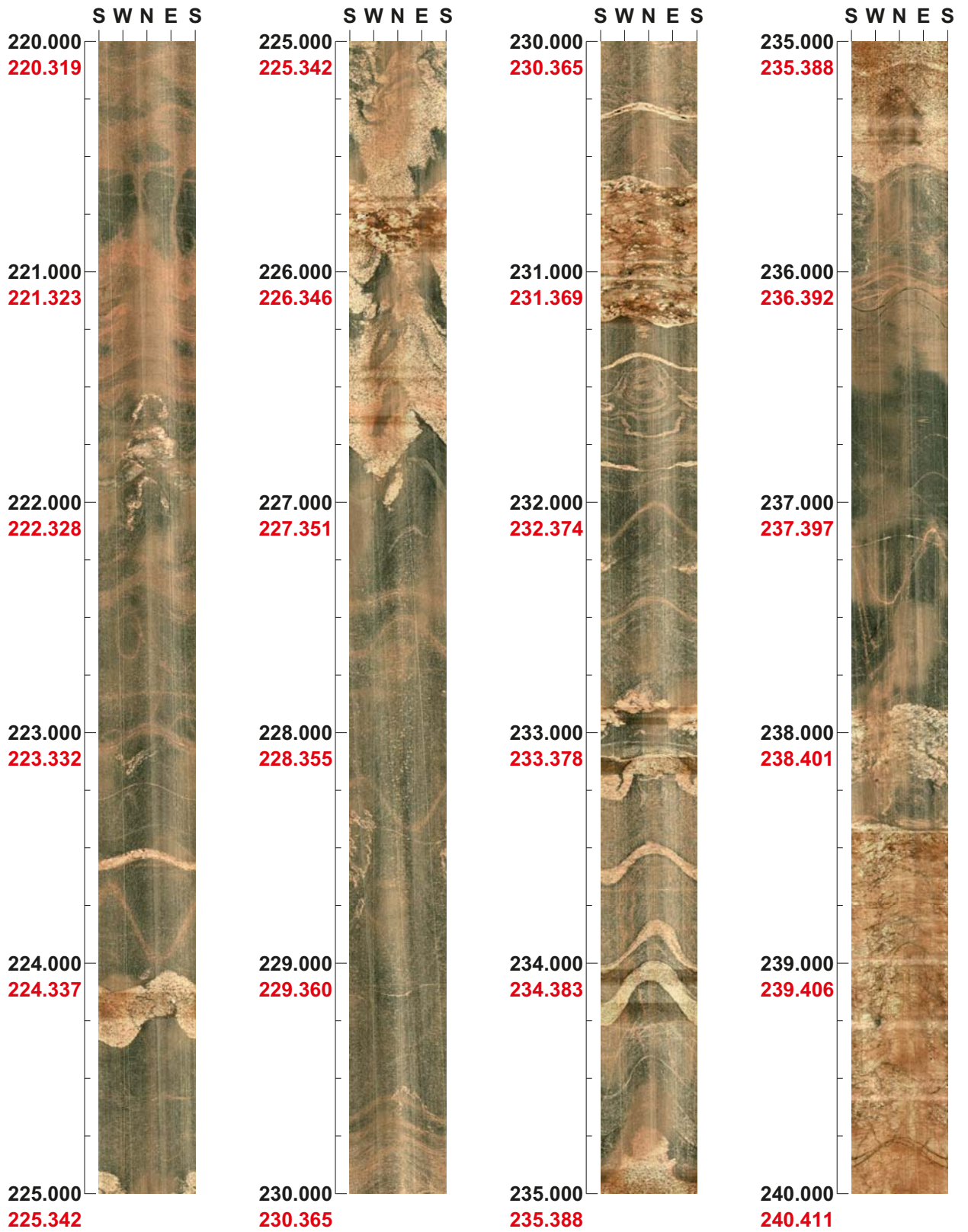

Project name: SFR
Bore hole No.: KFR27

Azimuth: 0

Inclination: -90

Depth range: 240.000 - 260.000 m

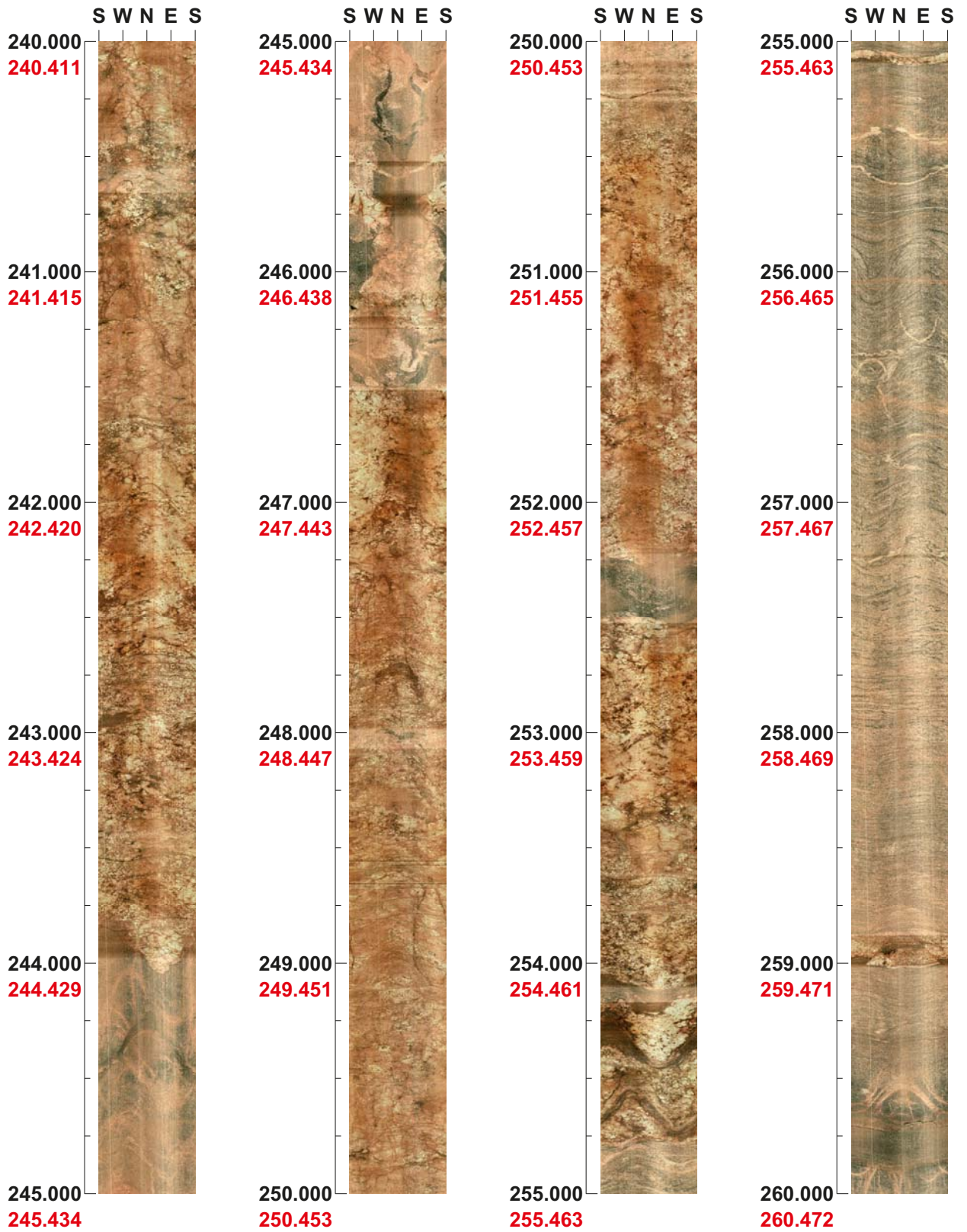

Project name: SFR
Bore hole No.: KFR27

Azimuth: 0

Inclination: -90

Depth range: 260.000 - 280.000 m



Project name: SFR
Bore hole No.: KFR27

Azimuth: 0

Inclination: -90

Depth range: 280.000 - 300.000 m

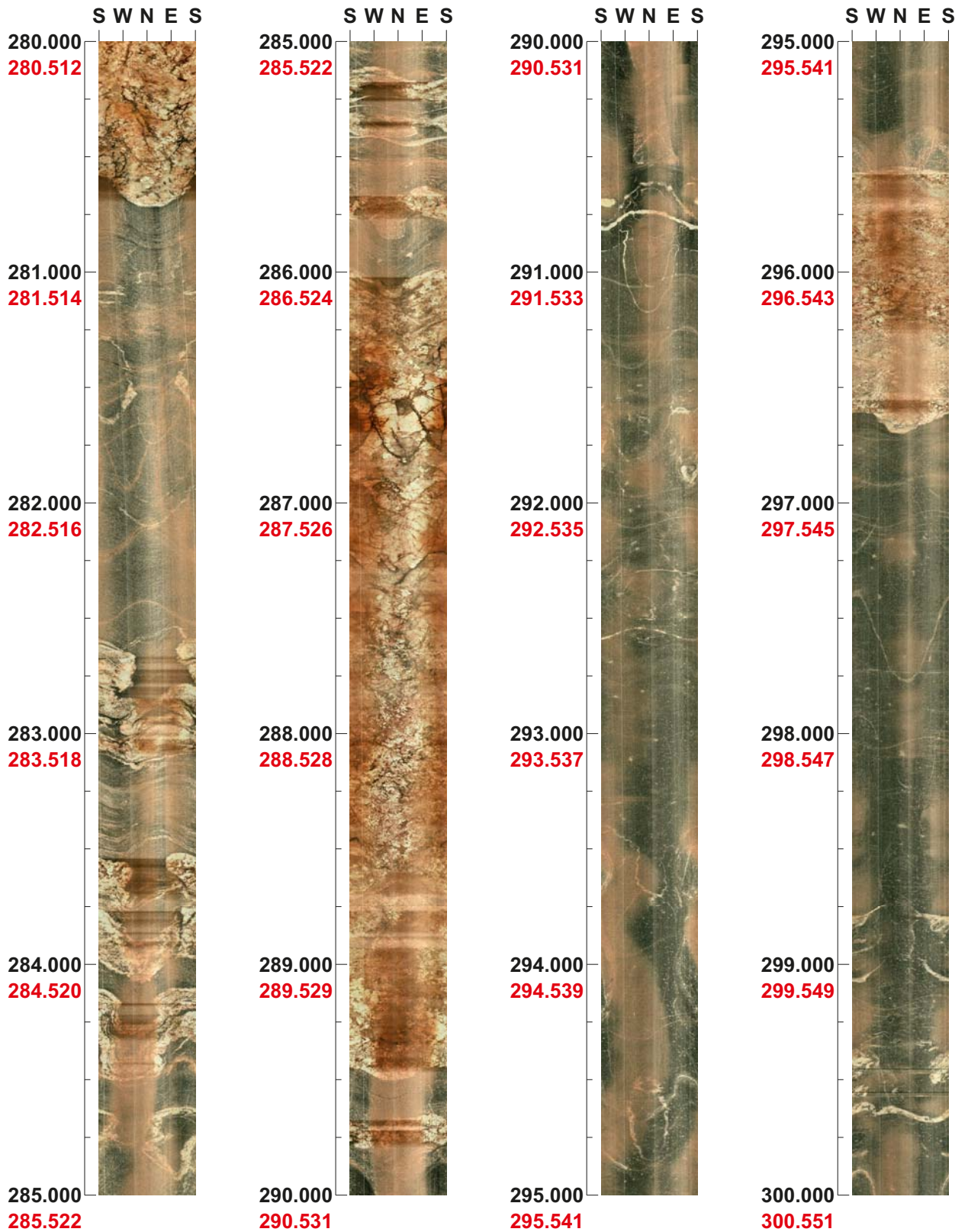

Project name: SFR
Bore hole No.: KFR27

Azimuth: 0

Inclination: -90

Depth range: 300.000 - 320.000 m

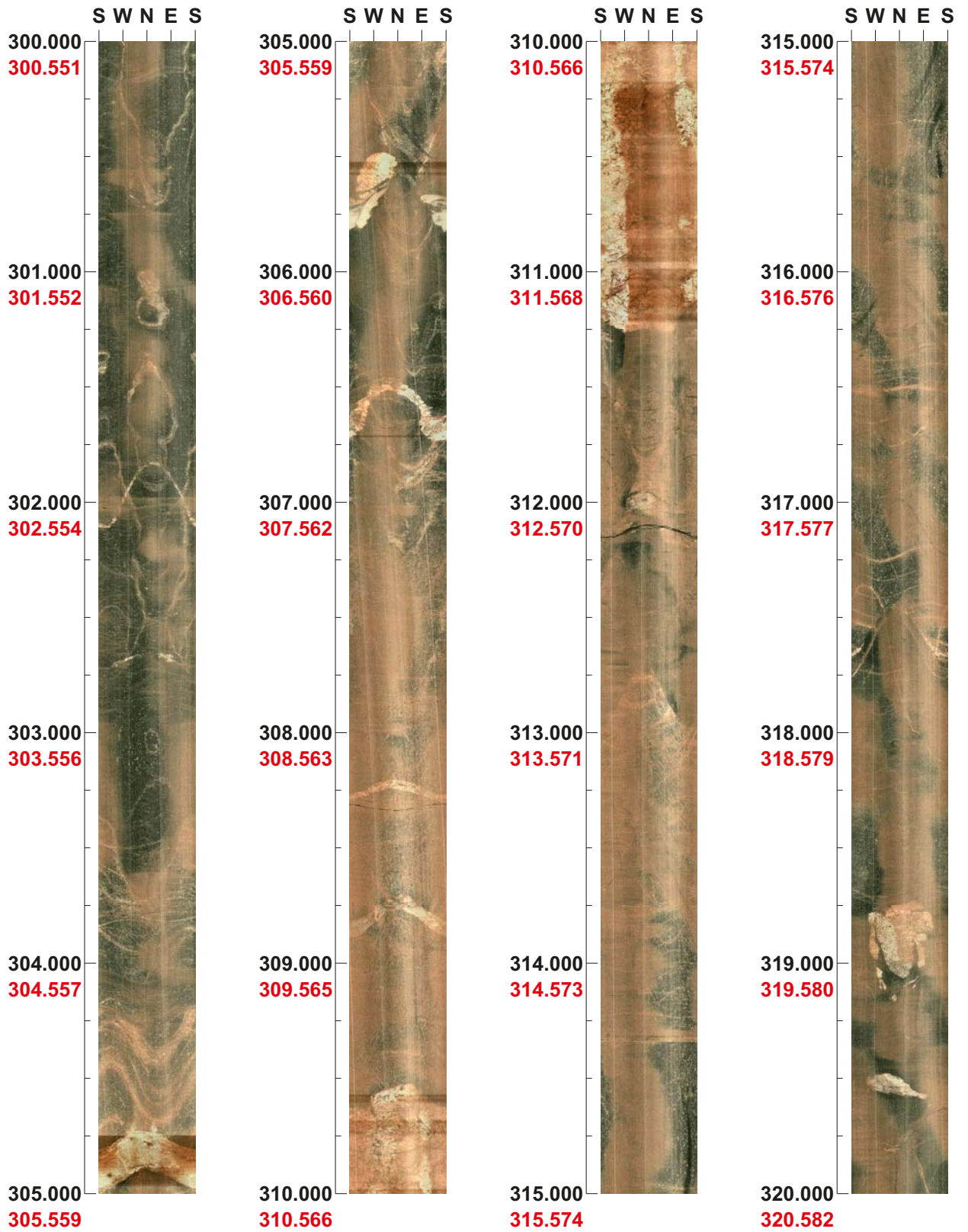

Project name: SFR
Bore hole No.: KFR27

Azimuth: 0

Inclination: -90

Depth range: 320.000 - 340.000 m

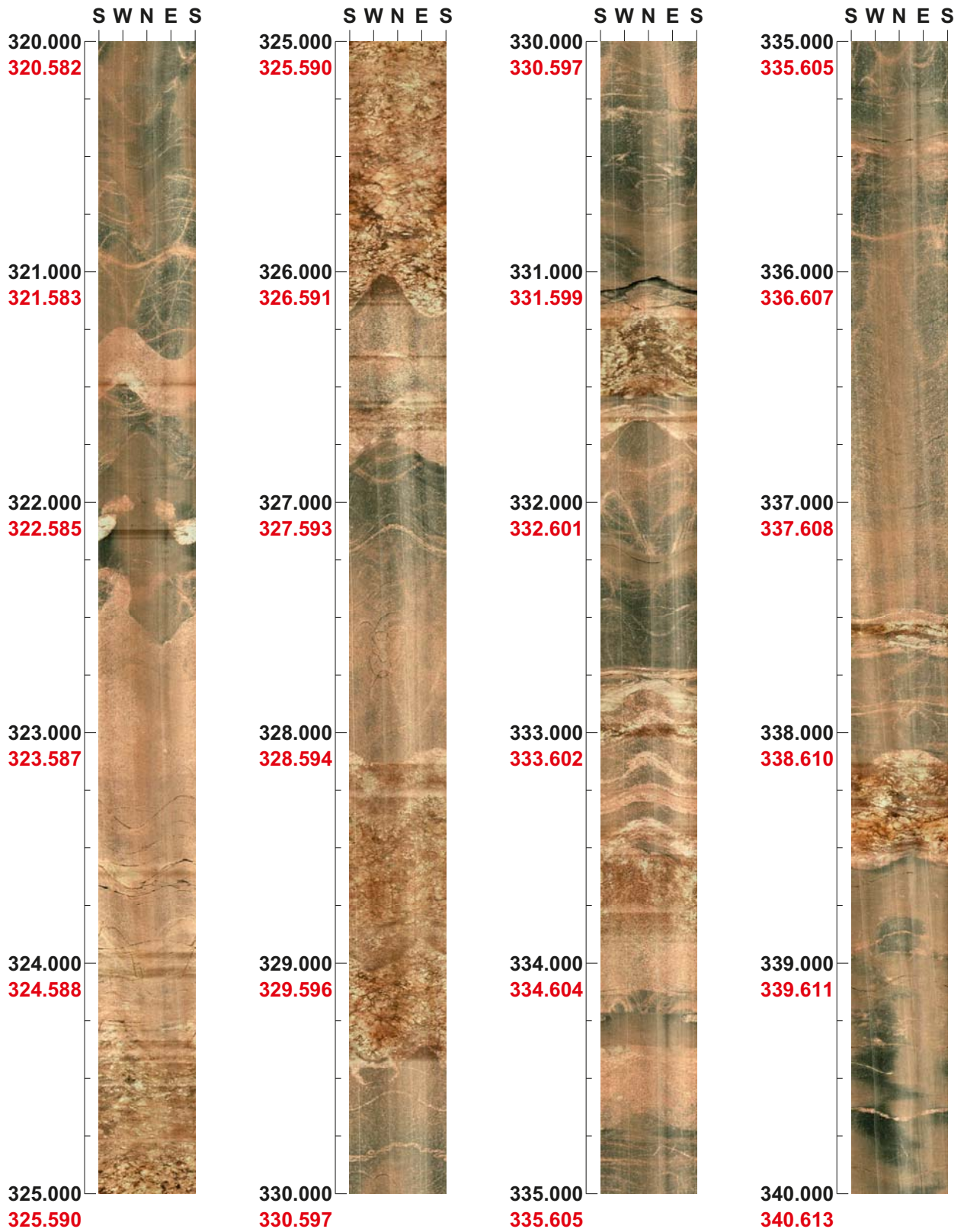

Project name: SFR
Bore hole No.: KFR27

Azimuth: 0

Inclination: -90

Depth range: 340.000 - 360.000 m

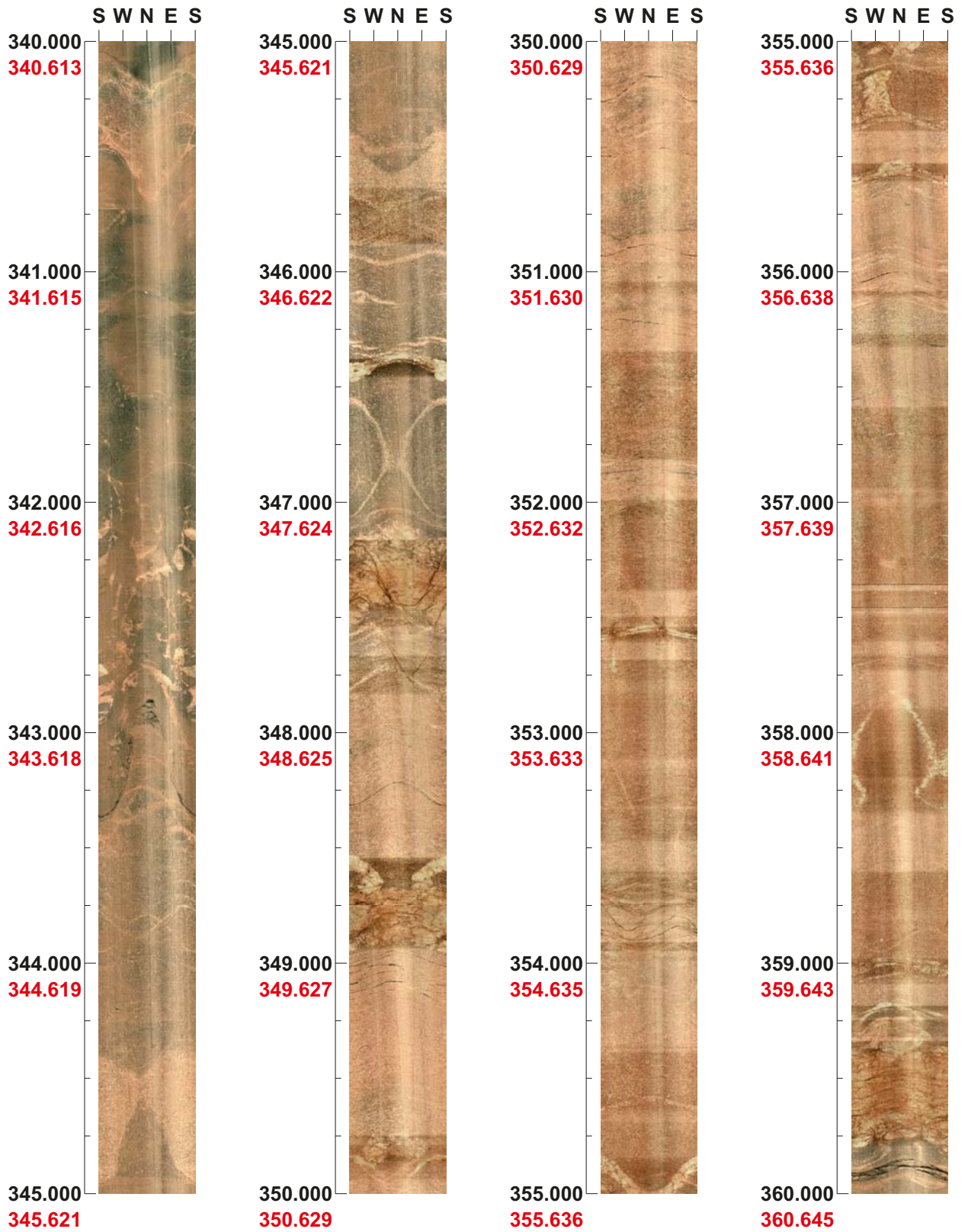

Project name: SFR
Bore hole No.: KFR27

Azimuth: 0

Inclination: -90

Depth range: 360.000 - 380.000 m

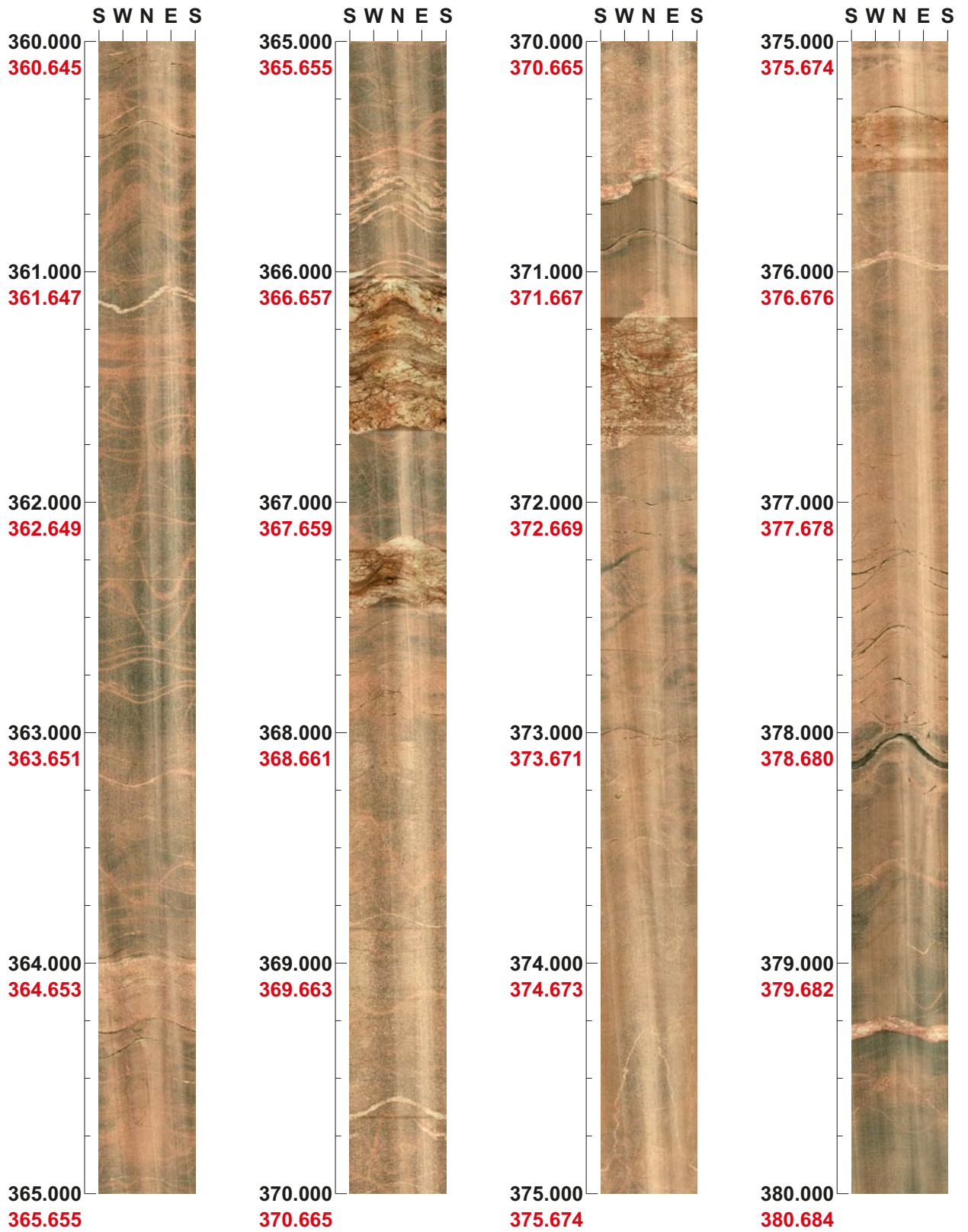

Project name: SFR
Bore hole No.: KFR27

Azimuth: 0

Inclination: -90

Depth range: 380.000 - 400.000 m

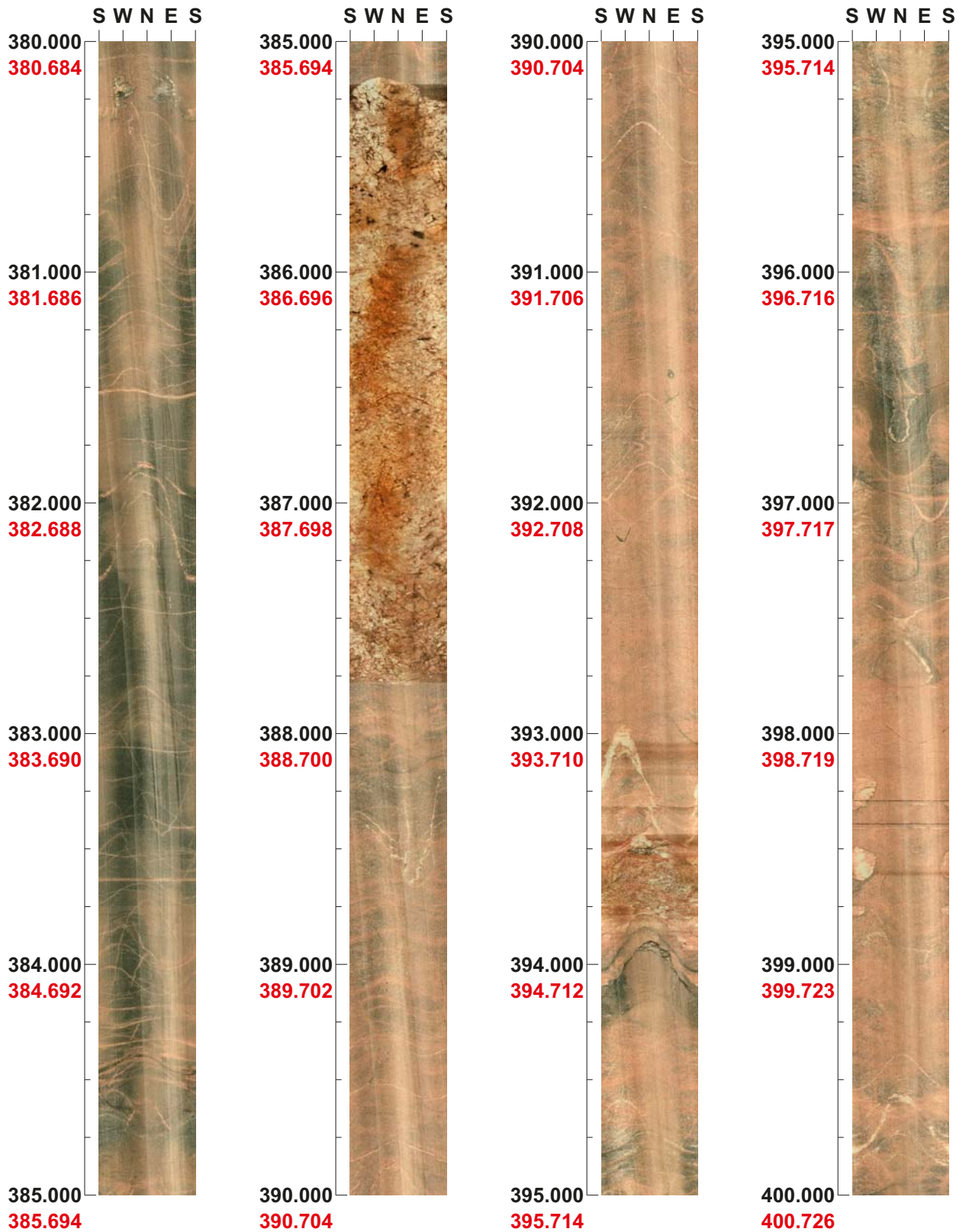

Project name: SFR
Bore hole No.: KFR27

Azimuth: 0

Inclination: -90

Depth range: 400.000 - 420.000 m

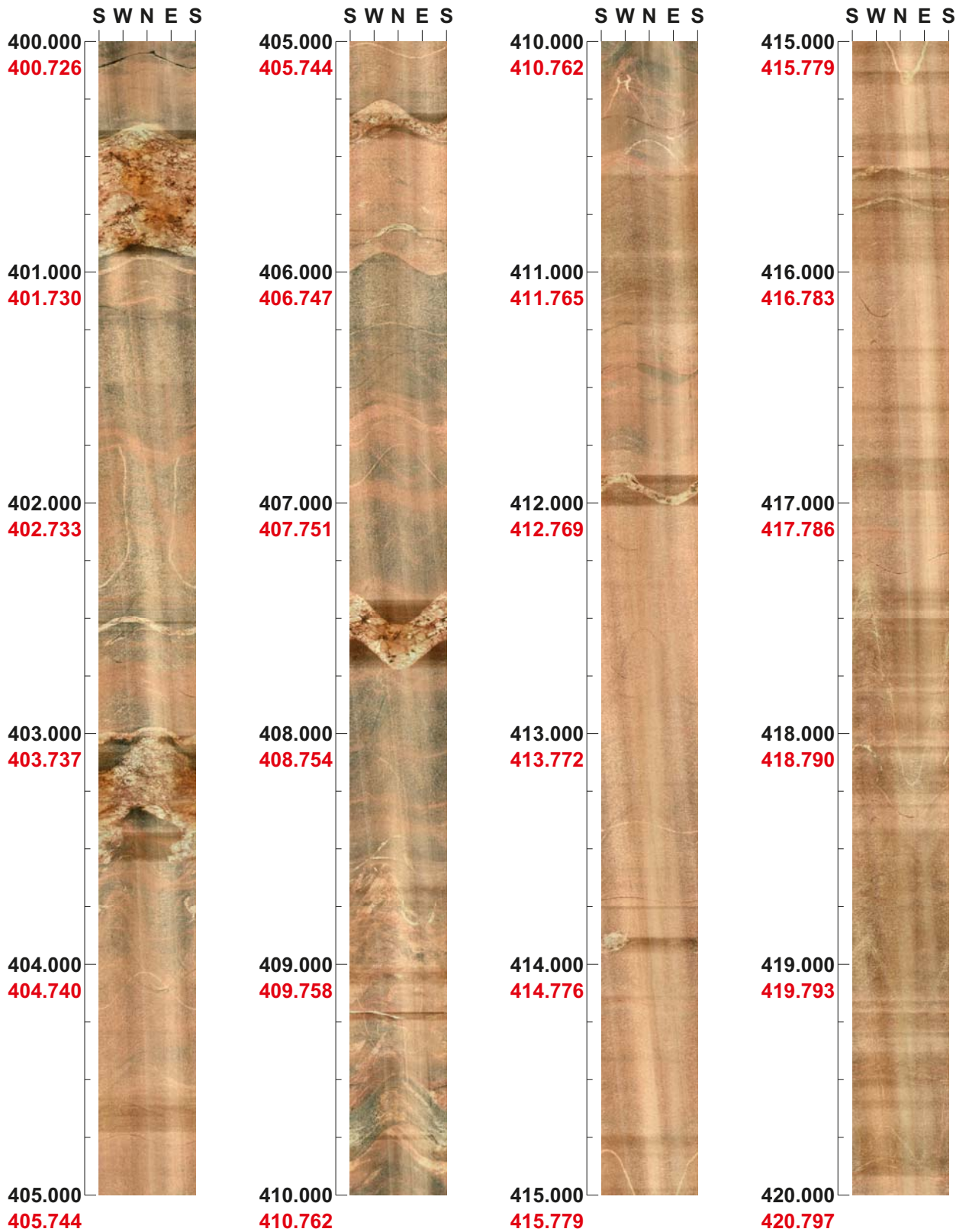

Project name: SFR
Bore hole No.: KFR27

Azimuth: 0

Inclination: -90

Depth range: 420.000 - 440.000 m

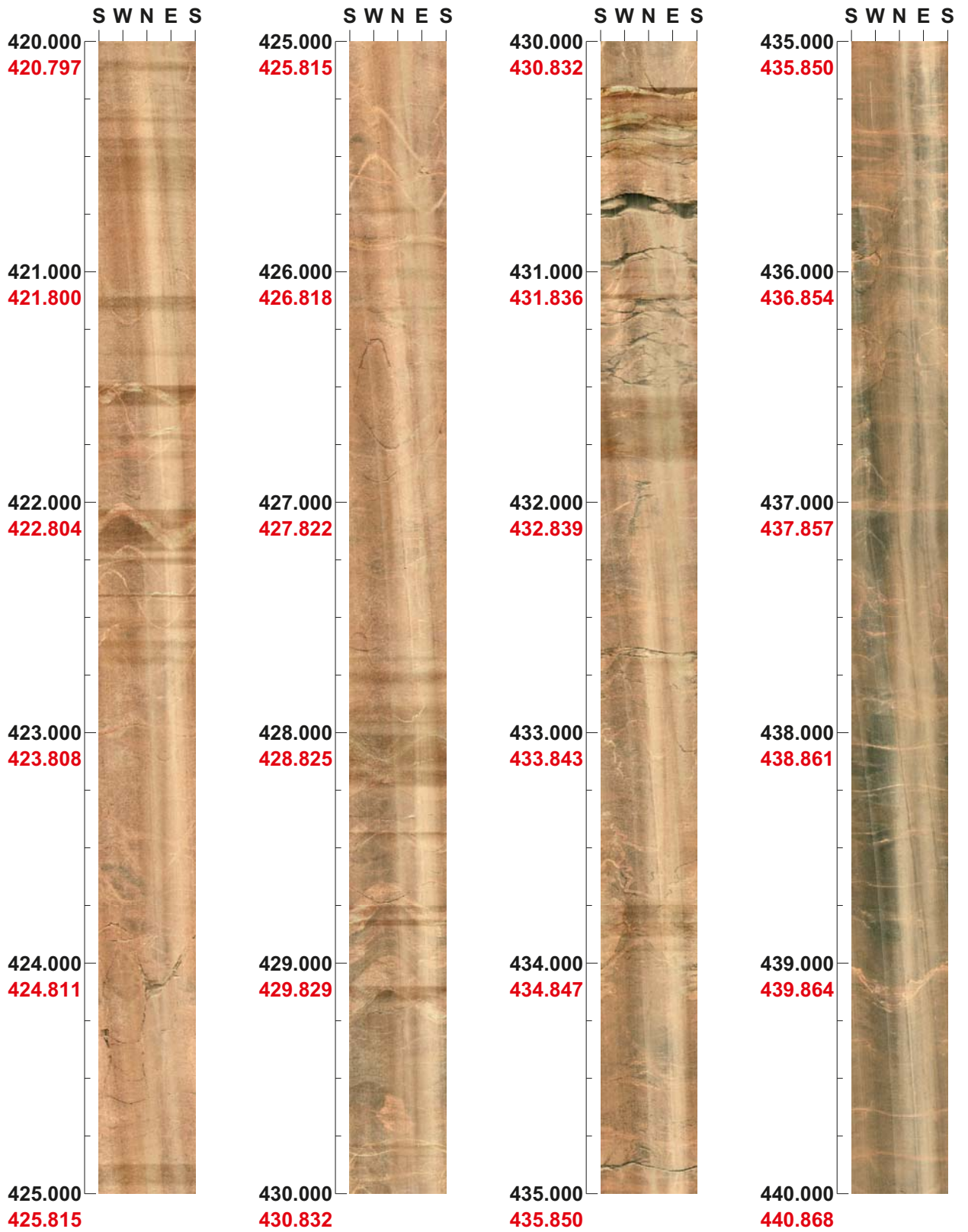

Project name: SFR
Bore hole No.: KFR27

Azimuth: 0

Inclination: -90

Depth range: 440.000 - 460.000 m

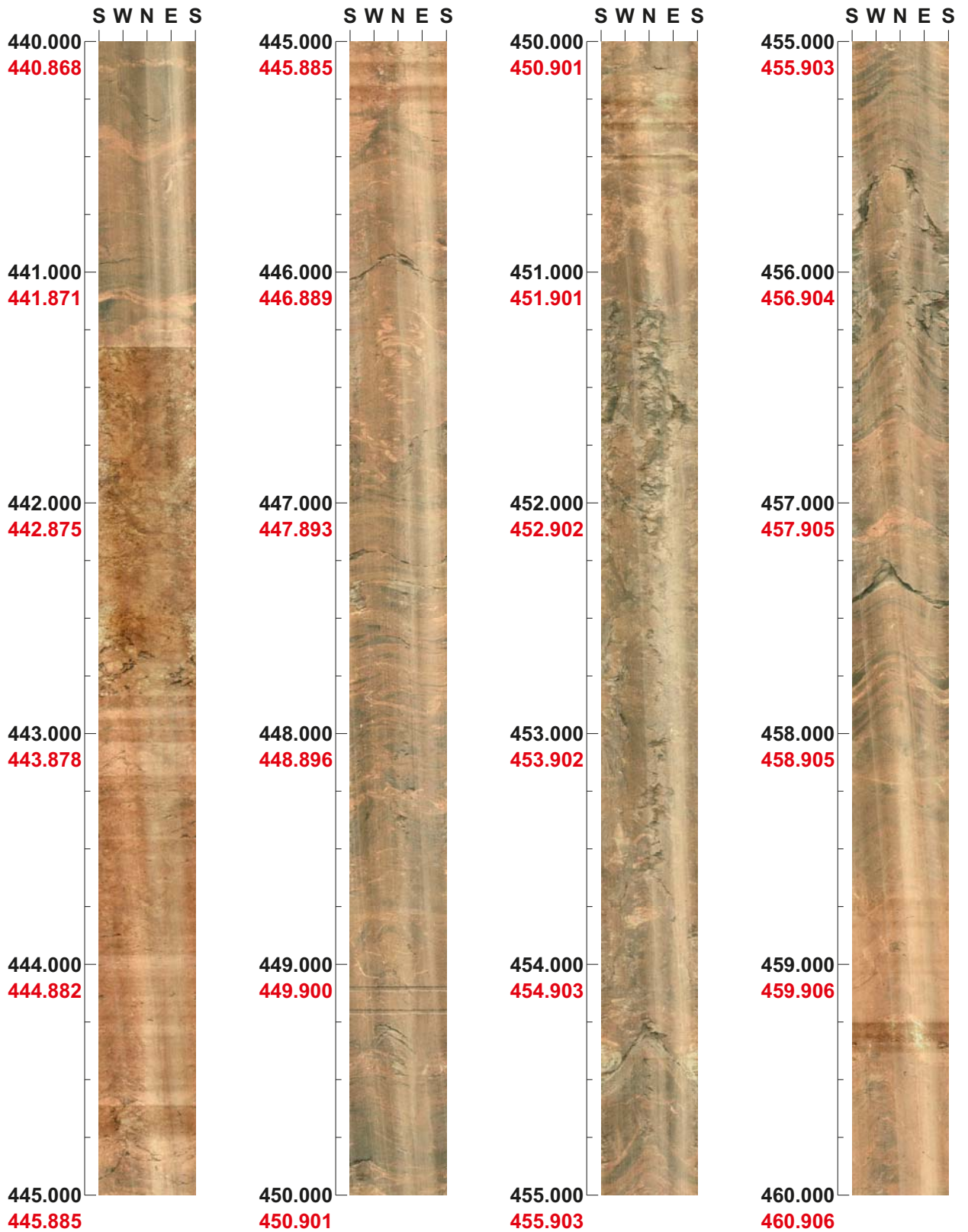

Project name: SFR
Bore hole No.: KFR27

Azimuth: 0

Inclination: -90

Depth range: 460.000 - 480.000 m



Project name: SFR
Bore hole No.: KFR27

Azimuth: 0

Inclination: -90

Depth range: 480.000 - 499.679 m

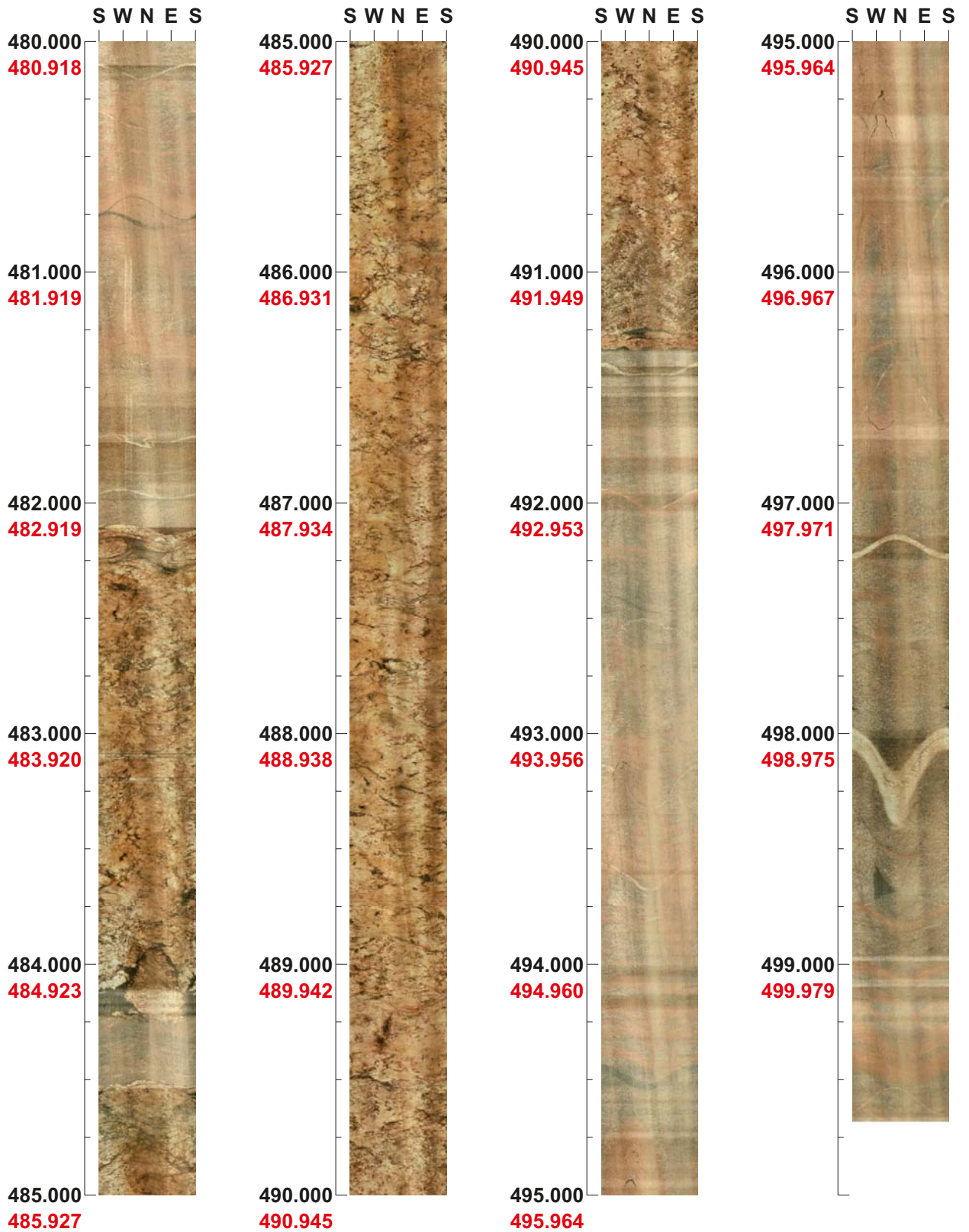

Appendix 9

Project name: SFR

Image file : c:\work\r5754s~1\2009-0~1\bipskf~1\kfr102~1.bip
BDT file : c:\work\r5754s~1\2009-0~1\bipskf~1\kfr102~1.bdt
Locality : SFR
Bore hole number : KFR102A
Date : 09/01/14
Time : 23:08:00
Depth range : 100.000 - 120.000 m
Azimuth : 302
Inclination : -65
Diameter : 76.0 mm
Magnetic declination : 0.0
Span : 4
Scan interval : 0.25
Scan direction : To bottom
Scale : 1/25
Aspect ratio : 175 %
Pages : 1
Color : 
 +0 +0 +0

Project name: SFR
Bore hole No.: KFR102A

Azimuth: 302 Inclination: -65

Depth range: 100.000 - 120.000 m

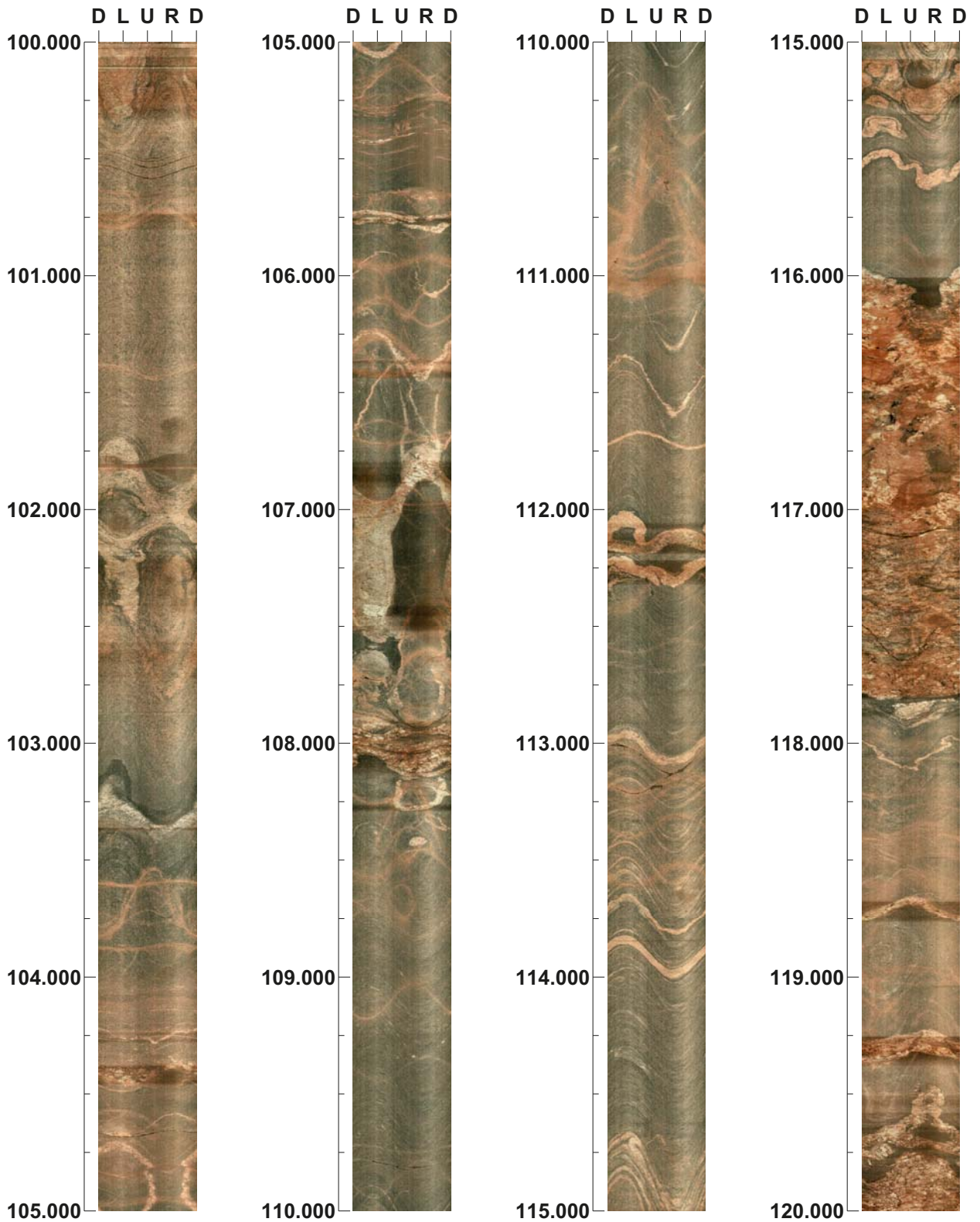

Appendix 10

Project name: SFR

Image file : c:\work\r5754s~1\2008-0~1\kfr102b\repeat~1.bip
BDT file :
Locality : FORSMARK
Bore hole number : KFR102B
Date : 08/09/10
Time : 15:30:00
Depth range : 100.000 - 111.004 m
Azimuth : 0
Inclination : -90
Diameter : 76.0 mm
Magnetic declination : 0.0
Span : 4
Scan interval : 0.25
Scan direction : To bottom
Scale : 1/25
Aspect ratio : 175 %
Pages : 1
Color : 

Depth range: 100.000 - 111.004 m



Appendix 11

Project name: SFR

Image file : c:\work\r5754s~1\2008-0~1\kfr103\repeat~1.bip
BDT file :
Locality : FORSMARK
Bore hole number : KFR103
Date : 08/09/11
Time : 10:40:00
Depth range : 50.000 - 60.007 m
Azimuth : 0
Inclination : -90
Diameter : 76.0 mm
Magnetic declination : 0.0
Span : 4
Scan interval : 0.25
Scan direction : To bottom
Scale : 1/25
Aspect ratio : 150 %
Pages : 2
Color : 

Project name: SFR
Bore hole No.: KFR103

Azimuth: 0

Inclination: -90

Depth range: 40.000 - 60.000 m

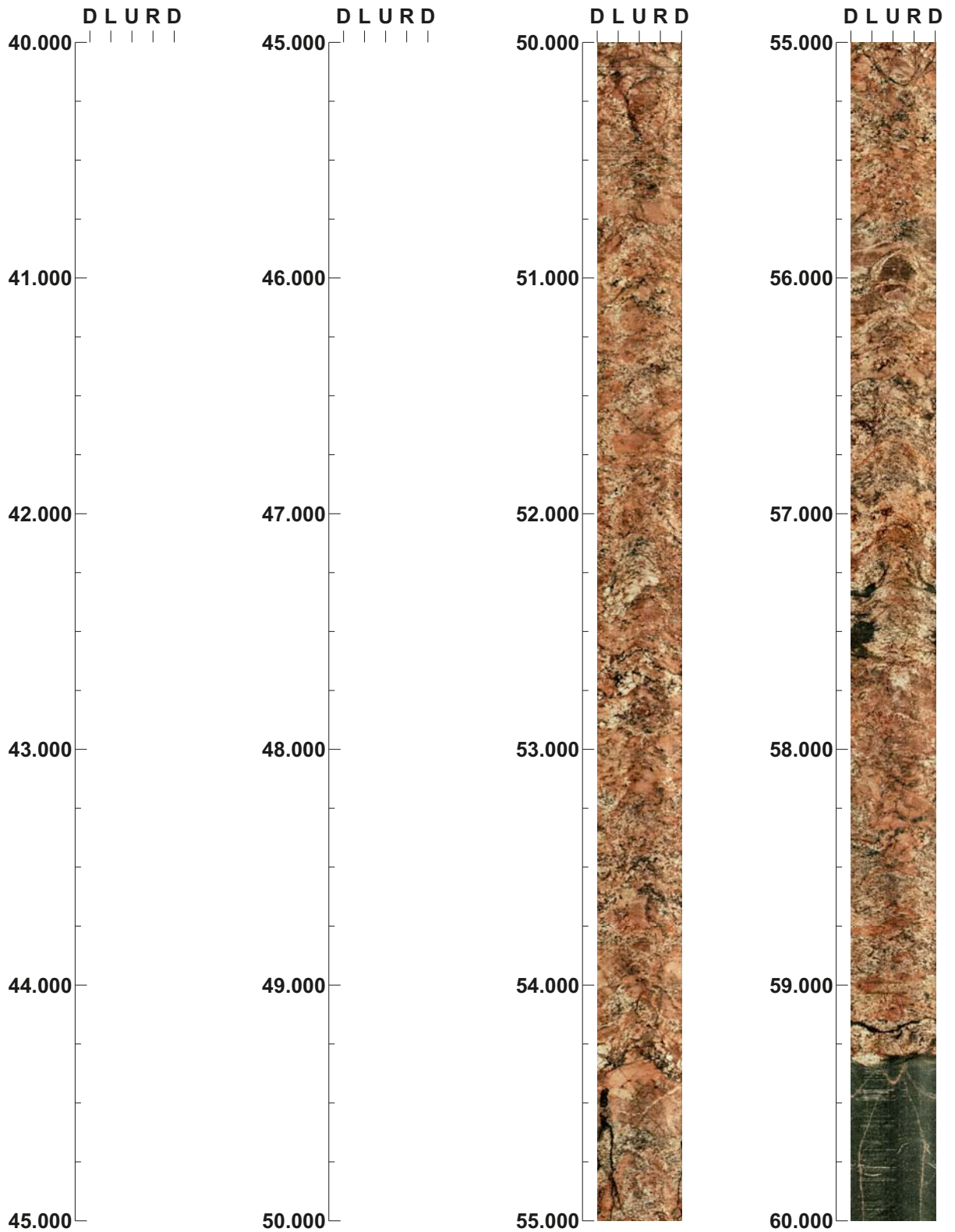

Appendix 12

Project name: SFR

Image file : c:\work\r5754s~1\2008-1~1\kfr104\bips\kfr104~4.bip
BDT file : c:\work\r5754s~1\2008-1~1\kfr104\bips\kfr104~4.bdt
Locality : SFR
Bore hole number : KFR104
Date : 08/10/14
Time : 23:40:00
Depth range : 200.000 - 220.005 m
Azimuth : 134
Inclination : -54
Diameter : 76.0 mm
Magnetic declination : 0.0
Span : 4
Scan interval : 0.25
Scan direction : To bottom
Scale : 1/25
Aspect ratio : 175 %
Pages : 2
Color : 
 +0 +0 +0

Project name: SFR
Bore hole No.: KFR104

Azimuth: 134 Inclination: -54

Depth range: 200.000 - 220.000 m

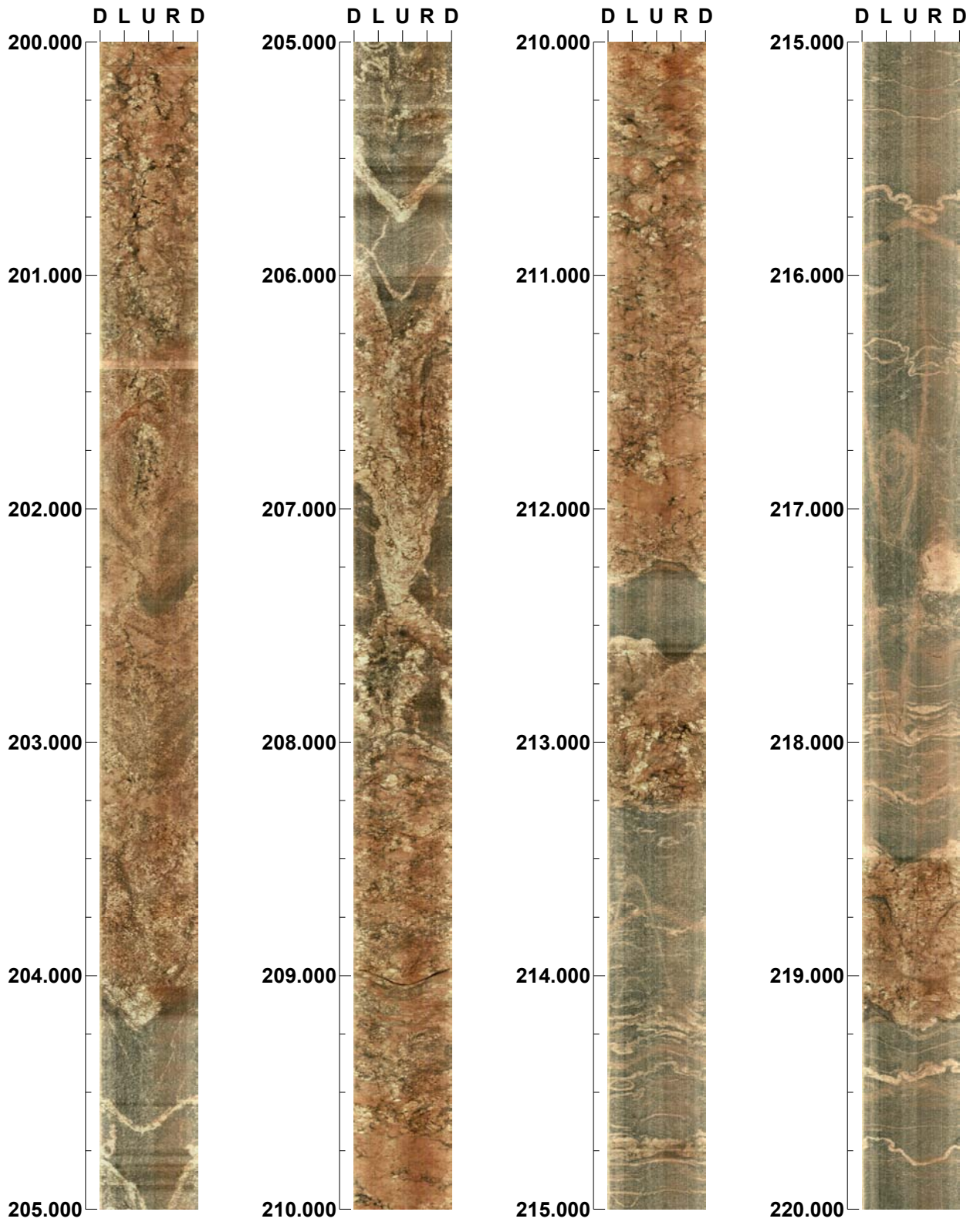

Project name: SFR
Bore hole No.: KFR104

Azimuth: 134 Inclination: -54

Depth range: 220.000 - 220.005 m

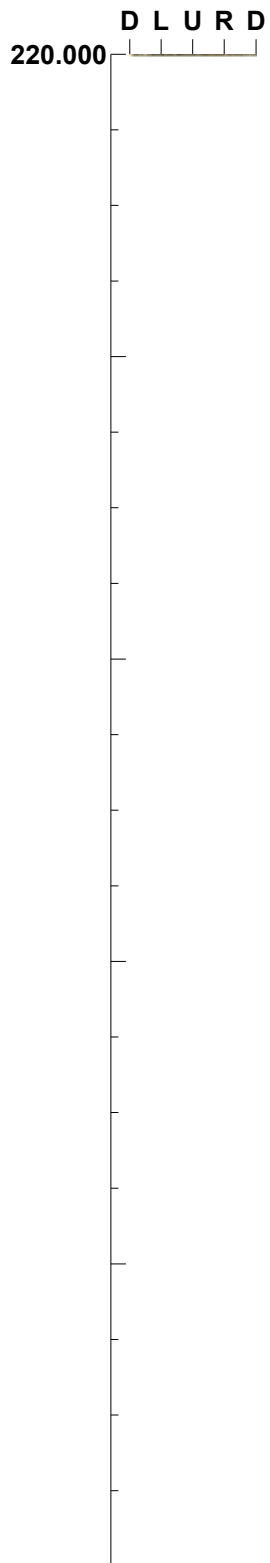

Appendix 13

Project name: SFR

Image file : c:\work\r5754s~1\2008-1~2\bipskf~1\kfr27_~2.bip
BDT file :
Locality : SFR
Bore hole number : KFR27
Date : 08/10/04
Time : 18:08:00
Depth range : 201.000 - 220.003 m
Azimuth : 0
Inclination : -90
Diameter : 76.0 mm
Magnetic declination : 0.0
Span : 4
Scan interval : 0.25
Scan direction : To bottom
Scale : 1/25
Aspect ratio : 175 %
Pages : 2
Color : 
 +0 +0 +0

Project name: SFR
Bore hole No.: KFR27

Azimuth: 0

Inclination: -90

Depth range: 200.000 - 220.000 m

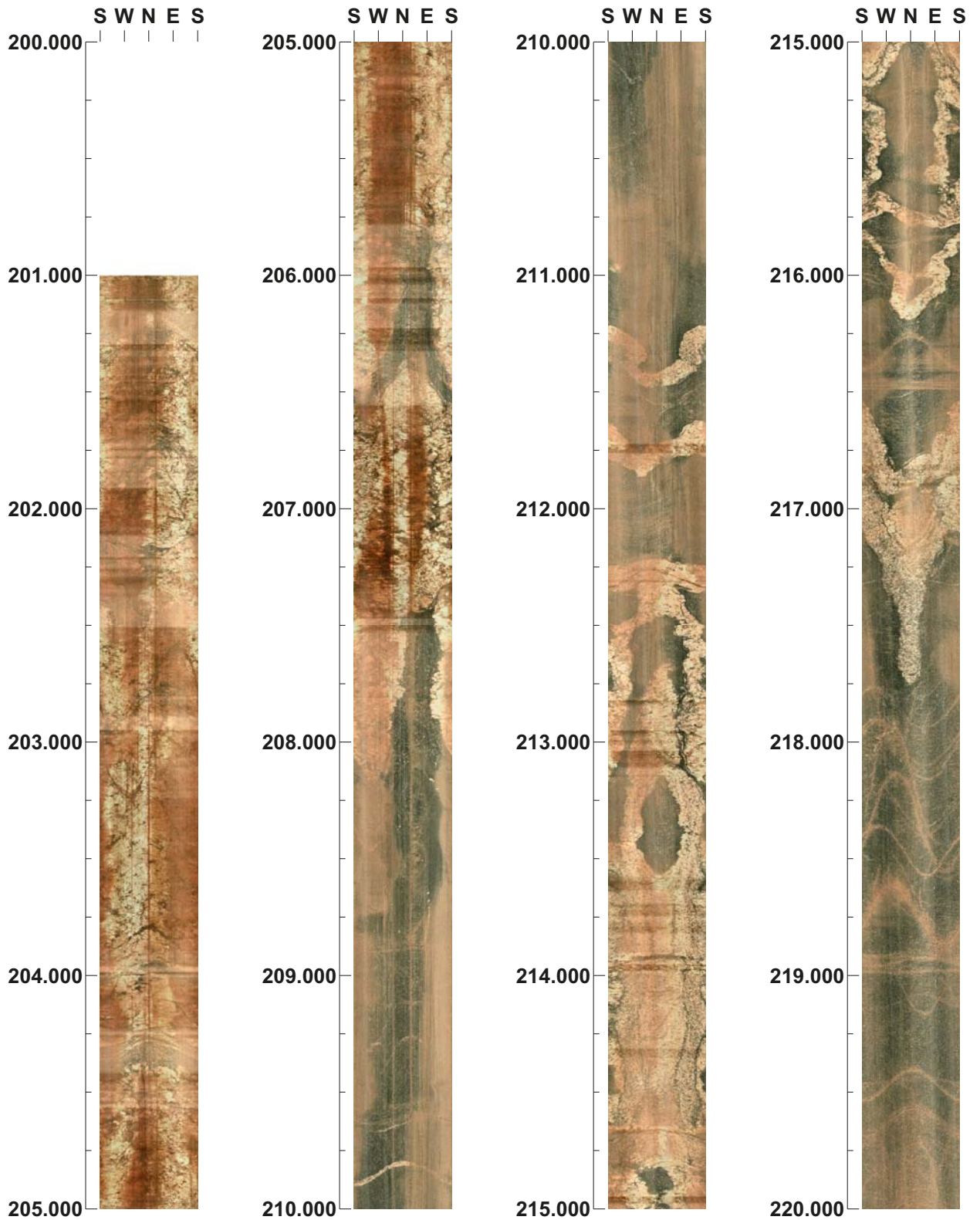

Project name: SFR
Bore hole No.: KFR27

Azimuth: 0

Inclination: -90

Depth range: 220.000 - 220.003 m

