

International
Progress Report

IPR-01-28

Äspö Hard Rock Laboratory

Backfill and Plug test

Sensor data report (Period: 990601 - 010701)

Report No: 3

Reza Goudarzi
David Gunnarsson
Lars-Erik Johannesson
Lennart Börgesson
Clay Technology AB

August 2001

Svensk Kärnbränslehantering AB

Swedish Nuclear Fuel
and Waste Management Co
Box 5864
SE-102 40 Stockholm Sweden
Tel +46 8 459 84 00
Fax +46 8 661 57 19



**Äspö Hard Rock
Laboratory**

Report no.	No.
IPR-01-28	F61K
Author	Date
Goudarzi, Gunnarsson, Johannesson, Börgesson,	
Checked by	Date
Approved	Date
Christer Svemar	01-09-21

Äspö Hard Rock Laboratory

Backfill and Plug test

Sensor data report (Period: 990601-010701)

Report No: 3

Reza Goudarzi
David Gunnarsson
Lars-Erik Johannesson
Lennart Börgesson
Clay Technology AB

August 2001

Keywords: Backfill and Plug test, data report

This report concerns a study which was conducted for SKB. The conclusions and viewpoints presented in the report are those of the author(s) and do not necessarily coincide with those of the client.

Abstract

This report presents data from the measurements in the Backfill and Plug Test during the period 99-06-01 to 01-01-07. Water pressure in the rock is measured in 73 points, pore water pressure in the backfill is measured in 33 points, total pressure is measured in 20 points and water pressure in the drainage layers of filter mats is measured in all 12 layers. The water saturation process in the backfill is checked in 57 measuring points.

The positions of the measuring points in the backfill are related to the backfill section, the number of the compacted layer, the tunnel axis, and the rock surface. The positions of the measuring points in the rock are related to the backfill section where the hole enters and the measuring section in the borehole.

The results from the last ½ year period confirm that the wetting process is very slow and that an increased water pressure in the mats is required in order to reach saturation within reasonable time.

Sammanfattning

I denna rapport presenteras data från mätningar i Backfill and Plug Test under period 99-06-01 till 01-07-01. Vattentryck i berget mäts i 73 punkter, porvattentryck i återfyllningen mäts i 33 punkter, totaltryck i 20 punkter och vattentryck i permeabla skikt av filtermattor mäts i alla 12 sektioner. Vatteninnehållet i återfyllningen mäts eller indikeras i 57 punkter.

Mätpunkternas positioner anges för återfyllningen i relation till återfyllningssektion, packningslager, tunnelcentrum och bergyta. För mätpunkterna i berget anges återfyllningssektion som borrhållet mynnar i, var på bergytan hålet mynnar och mätsektion i borrhållet.

Resultaten från den senaste halvårsperioden bekräftar att bevättningsprocessen är mycket långsam och att ett ökat vattentryck krävs i mattorna för att få vattenmättnad i rimlig tid.

Contents

Abstract	ii
Sammanfattning	ii
Contents	iii
1 Introduction	1
2 Comments	2
2.1 General	2
2.2 Total pressure, Glötzl	2
2.3 Total Pressure, Roctest	3
2.4 Suction, Wescore Psychrometers	3
2.5 Resistivity, resistivity probe	4
2.6 Indication of saturation, CT tube	4
2.7 Pore water pressure in backfill, Glötzl	4
2.8 Pore water pressure in backfill, Druck	4
2.9 Water flow into permeable sections	5
2.10 Water pressure in permeable sections	5
2.11 Water pressure in the rock, Druck	5
3 Geometry	6
4 Location of instruments in the backfill	8
4.1 Brief description of the instruments	8
4.2 Strategy for describing the position of each device	9
4.3 Position of each instrument in the backfill	12
5 Location of instruments in the rock	16
5.1 Brief description of the instruments	16
5.2 Position of each measuring section	18
6 Data from measurements in the backfill	20
6.1 Total pressure, Glötzl	20
6.2 Total pressure, Roctest	22
6.3 Suction, Wescore Psychrometers	23
6.4 Resistivity, CT resistivity probes	27
6.5 Pore water pressure, Glötzl	29
6.6 Pore water pressure, CT tube + Druck	33
6.7 Flow into permeable sections	36
6.8 Water pressure in permeable sections	41
7 Data from measurements in the rock	43
Quick guide	59

1 Introduction

The installation of the Backfill and Plug Test was made during spring 1999. The different measurements started at different times as the transducers were connected to their data acquisition systems. In this report the data acquired until 2001-07-01 are presented. In general the data in this report are presented in diagrams covering the time period 1999-06-01 to 2001-07-01. The time axis in the diagrams represents days from 1999-06-01 except for readings from the flow meters.

A Test overview with the positions of the permeable sections, the positions of the measuring points and a brief description of the instruments is also included in this report. A quick guide to the positions of all instruments in the backfill that can be unfolded to A3 format is enclosed as the last page. Explanation of denominations is presented in Chapter 4.

General comments concerning the collection of the data are also given.

2 Comments

2.1 General

In this chapter short comments on general trends in the measurements are given. Sensors that are not delivering reliable data or no data at all are noted and comments on the data collection in general are given.

Since the backfill is not water saturated and the plug has been leaking during the reported period, very low water pressure has been applied and measured in the backfill. On this reason most measurements of total and water pressure in the backfill yield values that are very low compared to the measuring range and the accuracy is thus not very high. This explains some of the irregularities in some of the curves.

The second report covered the period up to 010101. This report is the third one and covers the results up to 010701.

The plug was grouted on June 27. In connection with the grouting, the inflow into the mats close to the plug was reduced.

2.2 Total Pressure, Glötzl

Data are presented on pages 20-21.

The total pressure cells from Glötzl have not worked well and in late summer 2000 the regulation system broke down. It was sent for repair and was returned in December and the system reinstalled. The cells seem to yield reliable results now except for P62, which yields negative values.

The rather high pressure measured from most cells in section B (150-250 kPa) imply that there is a swelling pressure caused by the bentonite blocks installed at the roof in this section. The pressure measured in section A is lower and corresponds roughly to the water pressure plus the weight of the overburden for most cells.

2.3 Total pressure, Roctest

Data are presented on page 22.

All cells seem to deliver reliable data. The same trend can be observed as for the Glötzl cells, that is water pressure plus the weight of the overburden in section A and obvious swelling pressures in section B except for P61, which is placed in the roof close to the plug.

2.4 Suction, Wescore Psychrometers

Data are presented on pages 23-26.

The Psychrometers are mainly placed in the 30/70 backfill. The exceptions are W67 and W77 that are placed in the 0/100, and W83 and W84 that are placed among the bentonite blocks in B6. The psychrometers are not designed for measuring suction in these materials until they are very close to water saturation. Data from these sensors were not possible to evaluate and are therefore not presented.

These results are most interesting for evaluation of the wetting rate of 30/70, which is critical for when the flow testing can start.

The readings from the Psychrometers started earlier than 1999-06-01. Since the measurements earlier than that date did not differ from the measured results for days 0-100, that data has been excluded.

The suction of 30/70 is about 3000 kPa at the initial water content and decreases with increasing degree of saturation. At complete saturation the suction is about 1000 kPa or lower.

The measured values show that most sensors behave in a rational manner indicating that they function in a proper way. The following exceptions can be noted:

1. At some periods the scatter of measured values is rather high for a few transducers, especially at a period around 400 days. Some of this scatter is probably caused by outer disturbances. The problems have been overcome and good results are received after that period.
2. When the backfill is water saturated the transducers may give unreliable measurements, especially if free water has entered. This would explain the scatter in the late measurements of some transducers.

The following transducers are judged to be water saturated and may give unreliable results now or in future: W3, W5, W7, W12, W16, W18, W21, and W51. All these transducers except W5 are located either with only one layer (20 cm) between the transducer and the permeable mat or close to the rock. It is thus logical to conclude that the saturation has reached at least 20 cm from the mats or the rock surface. The reason for the low suction read by transducer W5 is unclear. It could either be caused by malfunction or water leakage (e.g. along the tubes; see chapter 2.8).

The following transducers have started to yield decreased values but do not seem to be completely water saturated: W1, W6, W17, and W20. All these transducers except W1 are located with two layers (40 cm) between the transducers and the mats. It is thus logical to conclude that some water has reached 40 cm into the layer and no water has reached half way between the mats (60 cm).

However, not very much has happened since the last reporting period (590 days). There is even some increase in measured suction in the last month, which may be caused by an increased temperature, due to that warmer air is pumped into the tunnel in the summer period. The results show that the wetting is very slow and that an increased water pressure is required in order to speed up the wetting.

2.5 Resistivity, resistivity probe

Data are presented on pages 27-28.

The purpose of using resistivity probes is to measure change in water content and to indicate when the bentonite free backfill (0/100) is saturated. Seven of the nine probes were installed in the 0/100 and the other two were installed in section A6. The probes were not originally designed for the 30/70 backfill. It has not been possible to evaluate the readings from the two probes placed in this material and the data from these are not presented.

The bentonite free backfill (0/100) has been wetted both through the mats and through leakage in the floor. The results indicate that only one transducer seems to be unaffected (W78).

2.6 Indication of saturation, CT tube

No water has come through the tubes placed in the backfill. W 63 and W66 were damaged during installation.

2.7 Pore water pressure in backfill, Glötzl

Data are presented on pages 29-32.

The measured pore water pressure is actually a mixture of air and water pressure. The water pressure is in general low but a slow increase with time can be noted. The strong increase in pressure from U2 and U24 after 600 days can be questioned.

2.8 Pore water pressure in backfill, Druck

Data are presented on pages 33- 35.

The principle of this measurement is to lead water from the test volume to the measuring house in a tube, connect it to the Druck transducer and measure the pressure. So far water has only come through from measuring points U13, U 53, U55 and U58.. Since the rest of the Druck transducers have so far only been measuring atmospheric pressure the data from these are not presented, except for transducer U5, which thus represents atmospheric pressure. The

pressure readings from the Druck transducers are related to the Z co-ordinate of the transducer in the measuring house. They are placed 0.5 – 1.5 m. below the centre point of the tunnel.

2.9 Water flow into permeable sections

Data are presented on pages 36-40.

The filling of the permeable mat sections was made in the following sequence: D3, D1, D5, D6, D2 and D4. The sequence for filling a mat was to let water flow into the bottom of the lower and the central mats till they were de-aired and water came from the top of the mats. The tube from the top of the mats was then closed. The filling was made carefully not to cause piping and to be able to follow the process. Different constellations between flow meters and permeable mats for different times were used to follow the process. The flow data is presented as flow to the different mats for the different constellations. After 340 days the same constellation has been used.

2.10 Water pressure in permeable mats, Druck

Data are presented on pages 41-42.

The pressures in the permeable layers are measured in the tubes leading to the centre positions of the centre mats. The pressure is related to the Z co-ordinate of the Druck pressure transducers in the measuring house. This corresponds well with the Z co-ordinate of the centre line of the tunnel. Since the tunnel is slightly inclined the centre point is about 3 dm above the level of the Druck sensors in D1 and about 1 dm below the sensors in D10.

The transducer connected to mat section D9 was changed in May 2001.

2.11 Water pressure in the rock, Druck

Data are presented on pages 43-58.

Only small changes of the water pressure in the rock have occurred during the last 6 months period. The pressure in the bore holes range from 0 to 3500 kPa. The highest pressures are found in the long boreholes. The pressure in the short bore holes in general range from 0 to 300 kPa. The exception is UR63 (left wall in section A1) that shows a pressure of 1500 kPa. The following transducers were changed in May 2001 due to malfunction: UR5, UR7, UR44, UR47 and UR66.

3 Geometry

The backfilled part is divided into backfill sections separated by drainage layers of permeable mats. The backfill sections are named 0, A1-A6 and B2-B6 and the mats are named D1-D12 according to Fig 3-1.

ÄSPÖ HARD ROCK LABORATORY- BACKFILL AND PLUG TEST IN ZEDEX DRIFT

Layout of the test

Numbering of backfill sections and permeable mats

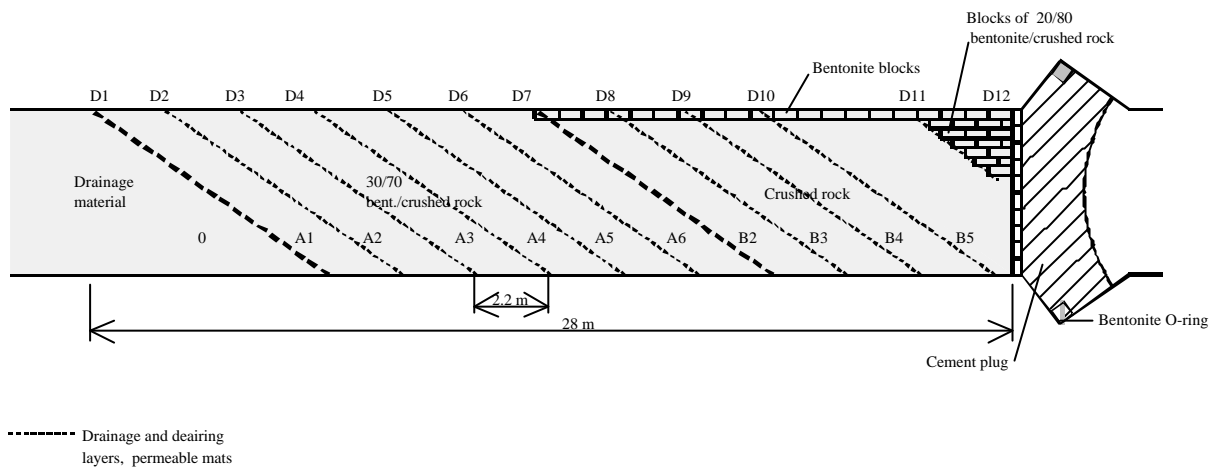

Figure 3-1 Numbering of backfill sections and drainage layers (permeable mats).

The permeable mats have been placed according to Fig 2-2. If the tunnel is supposed to be cylindrical the sections are elliptical with the large axis 8.7 m and the small axis 5.0 m. The tunnel axis is made the centre of a co-ordinate system with x and y co-ordinates. The drainage layer is divided into 3 parts with one upper, one central and one lower filter.

- The upper filter starts at $y=3.3$ m and fills the tunnel above that level. At the contact with the rock 0.2 m of filter mat is folded and attached to the rock surface in order to have a good hydraulic interaction with the rock.
- The central filter is placed at $-2.5 < y < 3.0$ and $-2.2 < x < 2.2$ as shown in Fig 3-2. The central filters have at least 0.3 m distance to the walls otherwise it has been cut to fulfil that demand.
- The lower filter has been placed between $y=-2.8$ and the floor with 0.2 m folded and attached to the floor. Since the floor is horizontal the ellipse is cut at about $y = -3.85$.

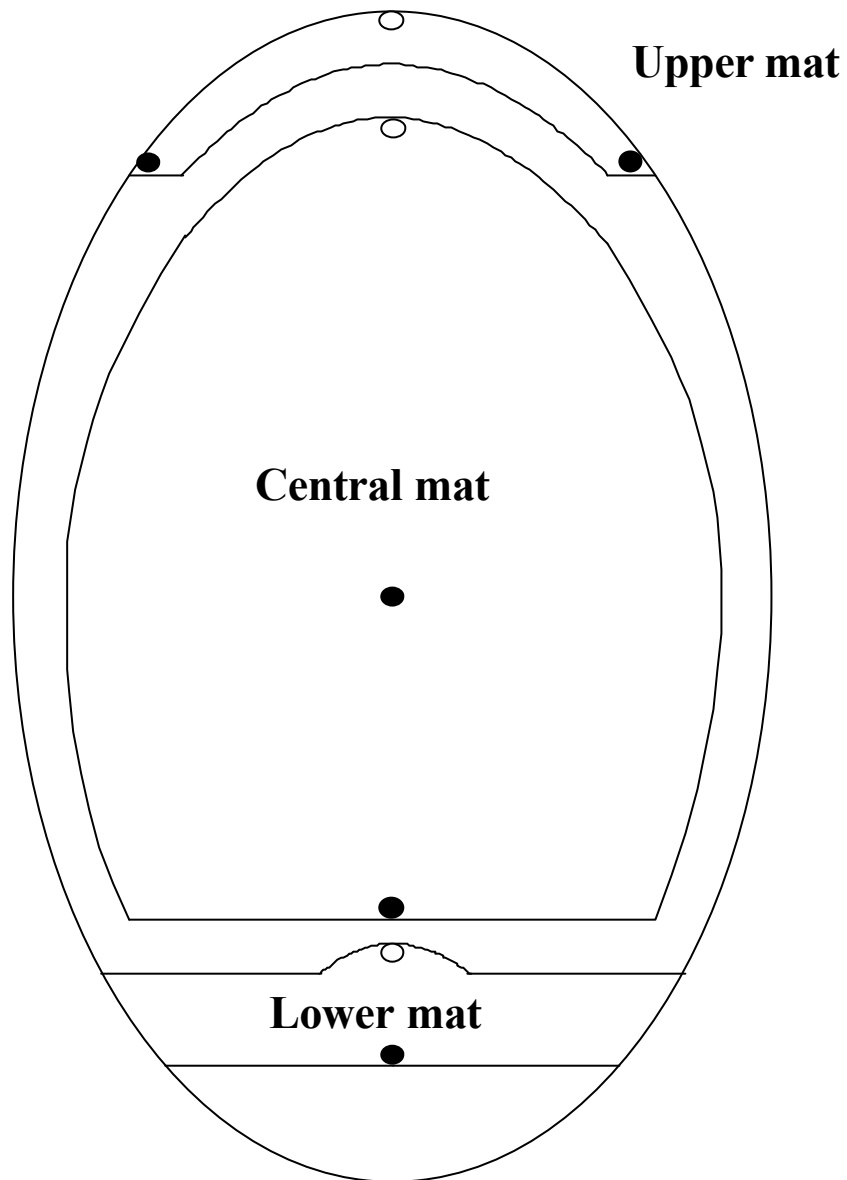

Figure 3-2. Location of the filters in a drainage layer.

Drainage layer D01 and D11 does not reach the floor. The central filter is cut 0.3 m from filter D12. Drainage layer D12 is made as the circular projection of the other drainage layers.

4 Location of instruments in the backfill

4.1 Brief description of the instruments

The different instruments that are used for measurements in the backfill are briefly described in this chapter.

4.1.1 Measurement of total pressure in the backfill

Total pressure is the sum of the swelling pressure (or effective stress) and the pore water pressure. It is measured with the following two instrument types:

- Glötzl total pressure cells of the hydraulic type. Two models have been used: E 10/20 KF 50 VA24 model A (Glötzl A) and model F (Glötzl B). The measuring range is 0-5 MPa. Type A is used for measurement in the soil while type B will be fixed to the rock surface with concrete. 9 cells of type A and 4 cells of type B are installed.
- Roctest total pressure cell with vibrating wire transducer model TPC-0 (0-4 MPa). 8 cells of this type are installed in the backfill.

4.1.2 Measurement of pore water pressure in the backfill

The pore water pressure in the backfill is measured with the following two instrument types:

- Glötzl pore pressure cells of the hydraulic type. 18 pore pressure cells of model P4 S 50L VA with the measuring range 0-5 MPa are installed.
- Filter tips connected to Druck pore water pressure cells model PTX 1400 with tecalan tubes. The pore water pressure cells are located outside the test area. 16 devices with the measuring range 0-4 MPa are installed.

4.1.3 Measurement of the water saturation process in the backfill

The water saturation process is followed by the following three different techniques:

- Wescor psychrometers model PST-55. These devices measure the relative humidity in the pore system, which can be converted into water ratio or total suction (negative water pressure). The measuring range is 95.5-99.6 RH corresponding to the pore water pressure -0.5 to -6 MPa or the water ratio 11-25% of backfill with the composition 30/70 bentonite/ballast mixture. 27 psychrometers have been installed.
- Resistivity probes developed and built by Clay Technology and the University of Lund are used in the bentonite free backfill. The measuring principle is to apply an electrical current between two outer electrodes with the relative distance 30 cm and measure the drop in

potential between two inner electrodes with the relative distance 10 cm. The devices have been calibrated for different densities and water ratios of the backfill intended to be used. The measuring range is water ratios between 5 and 12%. 10 devices are installed.

- Filter tips connected to thin tecalan tubes. These filters, which mainly have been installed in the bentonite free backfill, are simple devices for indicating when water saturation has occurred in the measuring point.

4.1.4 Measurement of temperature

Since no heat is generated in the experiment, temperature can be measured in two points for the purpose of general information. Thermocouples of type K from Heraeus Electro-Nite AB have been used. Temperature can also be measured by the psychrometers and by the devices for measuring hydraulic conductivity installed by ENRESA.

4.1.5 Other measurements

Local hydraulic conductivity will after water saturation be measured in section A4 with devices developed and installed by ENRESA in 13 points. These devices are not further dealt with in this report.

4.2 Strategy for describing the position of each device

Each instrument is named with a short unique name consisting of 1-2 letters describing the type of measurement and 1-3 figures numbering the device. In addition to the name a short description of the position is added.

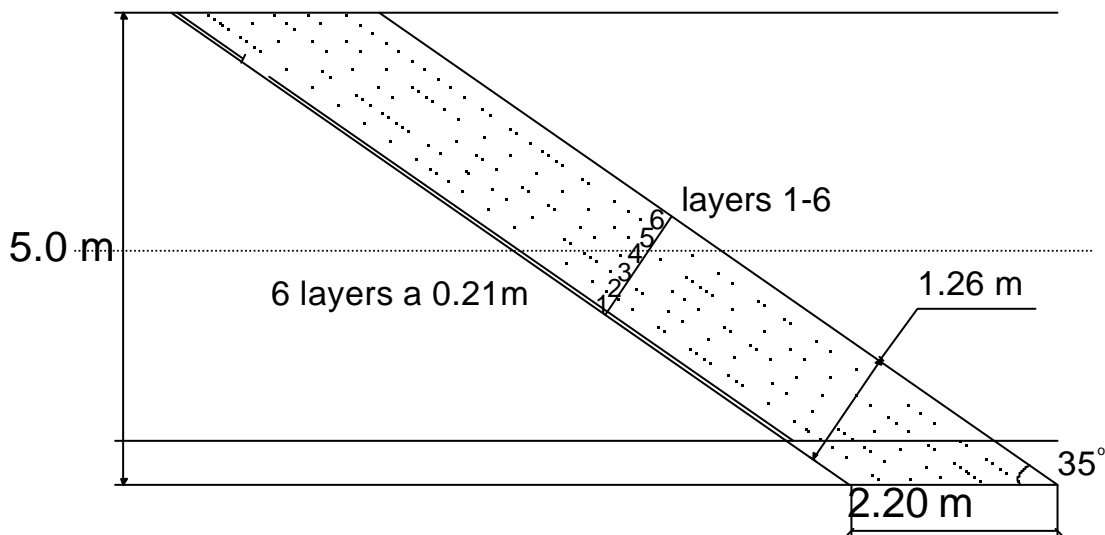

Figure 4-1. Subdivision of a backfill section into backfill layers.

The sections, separated by drainage layers, were shown in Fig 1-1. Sections A1-A6 and B2-B5 are divided into 6 layers with the thickness 0.21 m according to Fig 4-1. Each layer corresponds to one compaction sequence, which means that the backfill will be placed with a thickness before compaction that yields a thickness after compaction of 0.21 m. The layers are numbered 1-6.

The instruments have been placed in the layers after compaction and are related to those layers. Each measuring point is also defined by the co-ordinates in the layer in a co-ordinate system equal to the one shown in Fig 4-2. The x -coordinate is the horizontal distance from the centre of the tunnel and the y -coordinate is the distance perpendicular to the x -axis. Some of the instruments are more important to place at a specified distance from the rock surface. For those cases the co-ordinate begins with the letter R and is given the co-ordinate with the intersection with the rock surface as centre. An instrument in the backfill will thus be named in the following way:

1. Type of measurement (1 letter)
2. Serial number (1-2 figures)
3. Section (1 letter, 1 figure)
4. Layer (1 figure)
5. x -coordinate
6. y -coordinate

Items 1 and 2 identifies the device and items 3-6 describes the location. A pore water pressure transducer (number 8) located in section A2, layer 3, 0.5 m left of the centre line and 0.3 m below the roof in the y -direction will be named:

W8 (A2/3/-0.5/R-0.3)

Instrument locations

Sections A & B

Layers 1 -6

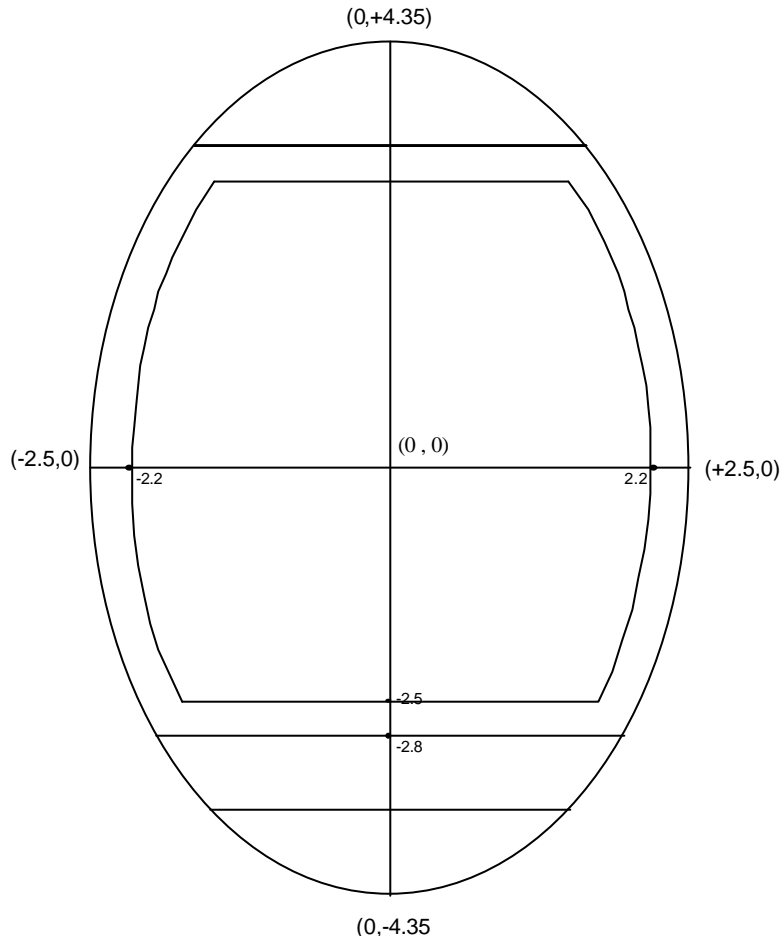

Figure 4-2. Co-ordinate system for measuring point in each sections and layers

4.3 Position of each instrument in the backfill

All instruments are placed in layers 1-4 in order to leave the two upper layers unaffected by transducers and cables. Another reason is that the entrance plate where the tubes are attached to the through connections are placed in layers 1-4, which means that the two final layers could be compacted without considering the problems of compacting around the through connections.

The positions of the instruments (except for ENRESA's hydraulic conductivity devices) are described in Tables 4-1 to 4-4.

Table 4-1 Numbering and position of instruments for measuring total pressure

Type and number	Section	Layer	X	Y	Fabricate	Remarks
P1	A3	1	0	R+0.2	Glötzl A	Horisontal
P2	A1	5	0	R-1.1	Glötzl A	Paralel
P3	A2	3	0	0,6	Rocktest	Paralel
P4	A2	3	0	R+0.65	Rocktest	Paralel
P5	A2	1	0	R-0.2	Rocktest	Paralel
P6	A2	6	0	-3,15	Glötzl A	Horisontal
P7	A4	3	0	R-0	Glötzl B	At rock
P8	A4	3	0	R+0	Glötzl B	At rock
P9	A5	3	0	R-0.2	GlötzlA	At rock
P51	A6	3	0	R-0.3	Rocktest	Under blocks
P52	B2	3	0	R-0	Glötzl A	Under blocks
P53	B2	3	0	0,2	Glötzl B	Horisontal
P54	B2	6	0	-2,78	Rocktest	Horisontal
P55	B3	3	0	0,3	Glötzl A	Paralel
P56	B3	3	0	R+0.65	Glötzl A	Paralel
P57	B2	7	0	R+1.1	Rocktest	Paralel
P58	B4	3	0	R-0	Glötzl A	Under blocks
P59	B3	5	0	R-1.1	Glötzl A	Paralel
P60	B4	1	0	R-0.2	Rocktest	Paralel
P61	B6	10	0	R-0	Rocktest	Between blocks
P62	B6	10	0	P	Glötzl B	At wall

Table 4-2 Numbering and position of instruments for measuring pore water pressure (U)

Type and number	Section	Layer	X	Y	Fabricate	Remarks
U1	A1	3	0	0,3	Glötzl	
U2	A1	3	0	3,1	Glötzl	
U3	A1	3	0	-2,6	Glötzl	
U4	A1	3	2	0	CT Tube + Druck	Twin tubes
U5	A1	3	-2	0	CT Tube + Druck	Twin tubes
U6	A2	1	0	0,3	Glötzl	
U7	A2	6	0,2	3,15	Glötzl	
U8	A3	1	0,25	-2,8	Glötzl	
U9	A1	5	-0,2	R-1.1	Glötzl	
U10	A2	3	0	0,3	Glötzl	
U11	A2	3	-0,2	R+0.65	Glötzl	
U12	A2	3	1,3	0	CT Tube + Druck	
U13	A2	3	-1,3	0	CT Tube + Druck	
U14	A2	6	-0,15	-0,1	Glötzl	
U15	A2	1	-0,2	R-0.2	Glötzl	
U16	A4	3	0	0,3	Glötzl	
U17	A4	3	0	R-0	Glötzl	
U18	A4	3	0	R+0	Glötzl	
U19	A4	3	R-0	0	Glötzl	
U20	A4	3	R+0	0	Glötzl	
U21	A5	3	0	0,3	Glötzl	
U22	A5	3	1,3	0	CT Tube + Druck	Twin tubes
U23	A5	3	-1,3	0	CT Tube + Druck	Twin Tubes
U24	A5	3	-0,2	R-0.2	Glötzl	
U51	A6	3	-0,2	R-0.3	CT Tube + Druck	Under the Blocks
U52	A6	3	-0,2	-2	CT Tube + Druck	Twin Tubes
U53	B3	1-2	0	R+0.05	CT Tube + Druck	
U54	B2	5	-0,2	R+0.2	CT Tube + Druck	marked as w66
U55	B2	6	-0,2	R+0.65	CT Tube + Druck	marked as w63
U56	B4	3	0	R-0	CT Tube + Druck	
U57	B3	5	-0,2	R-1.1	CT Tube + Druck	
U58	B4	1	-0,2	R-0.2	CT Tube + Druck	
U59	B6	10	0	R-0.05	CT Tube + Druck	
U60	B6	10	0	R-C-C	CT Tube + Druck	Twin Tubes

Table 4-3 Numbering and position of instruments for measuring water content (W)

Type and number	Section	Layer	X (m)	Y (m)	Fabricate	Remarks
W1	A1	1	0	0	Wescor Psychrometer	
W2	A1	3	0	0	Wescor Psychrometer	
W3	A1	5	0	0	Wescor Psychrometer	
W4	A2	1	0	0	Wescor Psychrometer	
W5	A2	3	0	0	Wescor Psychrometer	
W6	A2	4	0	0	Wescor Psychrometer	
W7	A3	1	0	0	Wescor Psychrometer	
W8	A3	3	0	0	Wescor Psychrometer	
W9	A3	3	0	2,5	CT Tube	
W10	A3	3	0	R-0.5	Wescor Psychrometer	
W11	A3	3	0	-2	CT Tube	
W12	A3	3	0	R+0.5	Wescor Psychrometer	
W13	A3	3	1,2	0	CT Tube	
W14	A3	3	R-0.3	0	Wescor Psychrometer	
W15	A3	3	-1,2	0	CT Tube	
W16	A3	3	R+0.3	0	Wescor Psychrometer	
W17	A3	4	0	0	Wescor Psychrometer	
W18	A4	1	0	0	Wescor Psychrometer	
W19	A4	3	0	0	Wescor Psychrometer	
W20	A4	4	0	0	Wescor Psychrometer	
W21	A5	1	0	0	Wescor Psychrometer	
W22	A5	3	0	0	Wescor Psychrometer	
W23	A5	3	0	2,5	Wescor Psychrometer	
W24	A5	3	0	-2	Wescor Psychrometer	
W25	A5	4	0	0	Wescor Psychrometer	
W51	A6	1	0	0	Wescor Psychrometer	
W52	A6	3	0	0	CT Res. Probe	
W53	A6	3	0	R-0.4	Ct Tube	
W54	A6	3	0	-2	Ct Tube	
W55	A6	3	-1,3	0	Ct Tube	
W56	A6	3	1,3	0	Ct Tube	
W57	A6	4	0	0	CT Res. Probe	
W58	B2	1	0	0	CT Res. Probe	
W59	B2	3	0	0	CT Res. Probe	
W60	B2	3	0	2,5	Ct Tube	
W61	B2	3	0	R-0.3	Ct Tube	Under the Blocks
W62	B2	3	0	-2	Ct Tube	
W64	B2	3	-1,3	0	Ct Tube	
W65	B2	3	1,3	0	Ct Tube	
W67	B3	1	0	0	Wescor Psychrometer	
W68	B3	3	0	0	CT Res. Probe	
W69	B3	3	0	R-0.3	CT Tube	Under the Blocks
W70	B3	3	1,3	0	CT Tube	
W71	B3	3	-1,3	0	CT Tube	
W72	B3	4	0	0	CT Res. Probe	

W73	B4	1	0	0	CT Res. Probe	
W74	B4	3	0	0	CT Res. Probe	
W75	B4	3	1,3	0	CT Tube	
W76	B4	3	-1,3	0	CT Tube	
W77	B5	2	0	0	Wescor Psychrometer	
W78	B5	5	0	0	CT Res. Probe	
W79	B5	8	0	2	CT Res. Probe	
W80	B5	8	2	2	Ct Tube	
W81	B5	8	-2	2	Ct Tube	
W82	B5	11	0	2	Ct Tube	
W83	B6	5	0	R-C-C	Wescor Psychrometer	
W84	B6	15	0	R-C-C	Wescor Psychrometer	

5 Location of instruments in the rock

5.1 Brief description of the instruments and the packers

Only water pressure is measured in the rock. The measurements are made in core drilled bore holes sealed with bentonite packers with the following measuring technique:

- Tecalan tubes from the packer are connected to Druck pore water pressure cells model PTX 1400. The pore water pressure cells are located in the measuring house. Measurements are made in 79 bore hole sections (measuring range 0-4 MPa).

Measurements are made in 1-3 sections in the bore holes. Most of the holes are only 1 m long with 1 packer installed in the outer 0.5 m. Two tubes are lead into each measuring section for deairing purpose. The measuring sections are sealed with packers with bentonite rings surrounded by rubber sealings.

5.1 Position of each measuring section

The measuring sections are identified with two letters and 2-3 figures. The letters are U (for pore water pressure) and R (for rock). The numbers are given in the following way:

Short holes in roof: 1-12

Long holes in the roof: 101-107

Short holes in the right wall (seen from the entrance of the drift): 21-32

Long holes in the right wall: 121-129

Short holes in floor: 41-52

Long holes in the floor: 141-147

Short holes in left wall: 61-72

Long holes in the roof: 161-167

Long hole in the end of the drift: 121

Table 5-1 shows the location of the measuring section for each instrument and the corresponding bore hole number. The backfill section in where the bore hole starts is also given

Figs 5-1 and 5-2 show the location of the measuring sections in vertical and horizontal cross sections.

Table 5-1 Numbering and positions of instruments for measuring pore water pressure in the rock

Type and number	Location	Measuring sect. (m)	Bore hole number	Section (TC)	Fabricate	Diameter (mm)	Remarks
UR1	Roof	0.5-1.0	KZ0065I01	A1	Druck	56	
UR2	Roof	0.5-1.0	KZ0063I01	A2	Druck	56	
UR3	Roof	0.5-1.0	KZ0061I01	A3	Druck	56	Closed ?
UR4	Floor	0.5-1.0	KZ0052G01	A4	Druck	56	
UR5	Roof	0.5-1.0	KZ0057I01	A5	Druck	56	
UR6	Roof	0.5-1.0	KZ0054I01	B1	Druck	56	
UR7	Roof	0.5-1.0	KZ0052I01	B2	Druck	56	
UR8	Roof	0.5-1.0	KZ0050I01	B3	Druck	56	
UR9	Roof	0.5-1.0	KZ0048I01	B4	Druck	56	
UR10	Roof	0.5-1.0	KZ0046I01	B5	Druck	56	
UR11	Roof	0.5-1.0	KZ0043I01	B5	Druck	56	
UR12	Roof	0.5-1.0	KZ0041I01	B5	Druck	56	
UR21	Right wall	0.5-1.0	KZ0066B01	O	Druck	56	
UR22	Right wall	0.5-1.0	KZ0064B01	O	Druck	56	
UR23	Right wall	0.5-1.0	KZ0061B01	A1	Druck	56	
UR24	Floor	0.5-1.0	KZ0057B01	A2	Druck	56	
UR25	Right wall	0.5-1.0	KZ0057B01	A3	Druck	56	
UR26	Right wall	0.5-1.0	KZ0055B01	A4	Druck	56	
UR27	Right wall	0.5-1.0	KZ0053B01	A5	Druck	56	
UR28	Right wall	0.5-1.0	KZ0050B01	B1	Druck	56	
UR29	Right wall	0.5-1.0	KZ0048B01	B2	Druck	56	
UR30	Right wall	0.5-1.0	KZ0046B01	B3	Druck	56	
UR31	Right wall	0.5-1.0	KZ0044B01	B4	Druck	56	
UR32	Right wall	0.5-1.0	KZ0042B01	B5	Druck	56	
UR41	Floor	0.5-1.0	KZ0065G01	O	Druck	56	
UR42	Floor	0.5-1.0	KZ0063G01	O	Druck	56	
UR43	Floor	0.5-1.0	KZ0061G01	O	Druck	56	
UR44	Floor	0.5-1.0	KZ0059G01	A1	Druck	56	
UR45	Right wall	0.5-1.0	KZ0059G01	A2	Druck	56	One tube
UR46	Floor	0.5-1.0	KZ0054G01	A3	Druck	56	plugged
UR47	Roof	0.5-1.0	KZ0059I01	A4	Druck	56	
UR48	Floor	0.5-1.0	KZ0050G01	A5	Druck	56	
UR49	Floor	0.5-1.0	KZ0048G01	B1	Druck	56	
UR50	Floor	0.5-1.0	KZ0046G01	B2	Druck	56	
UR51	Floor	0.5-1.0	KZ0043G01	B3	Druck	56	
UR52	Floor	0.5-1.0	KZ0041G01	B4	Druck	56	

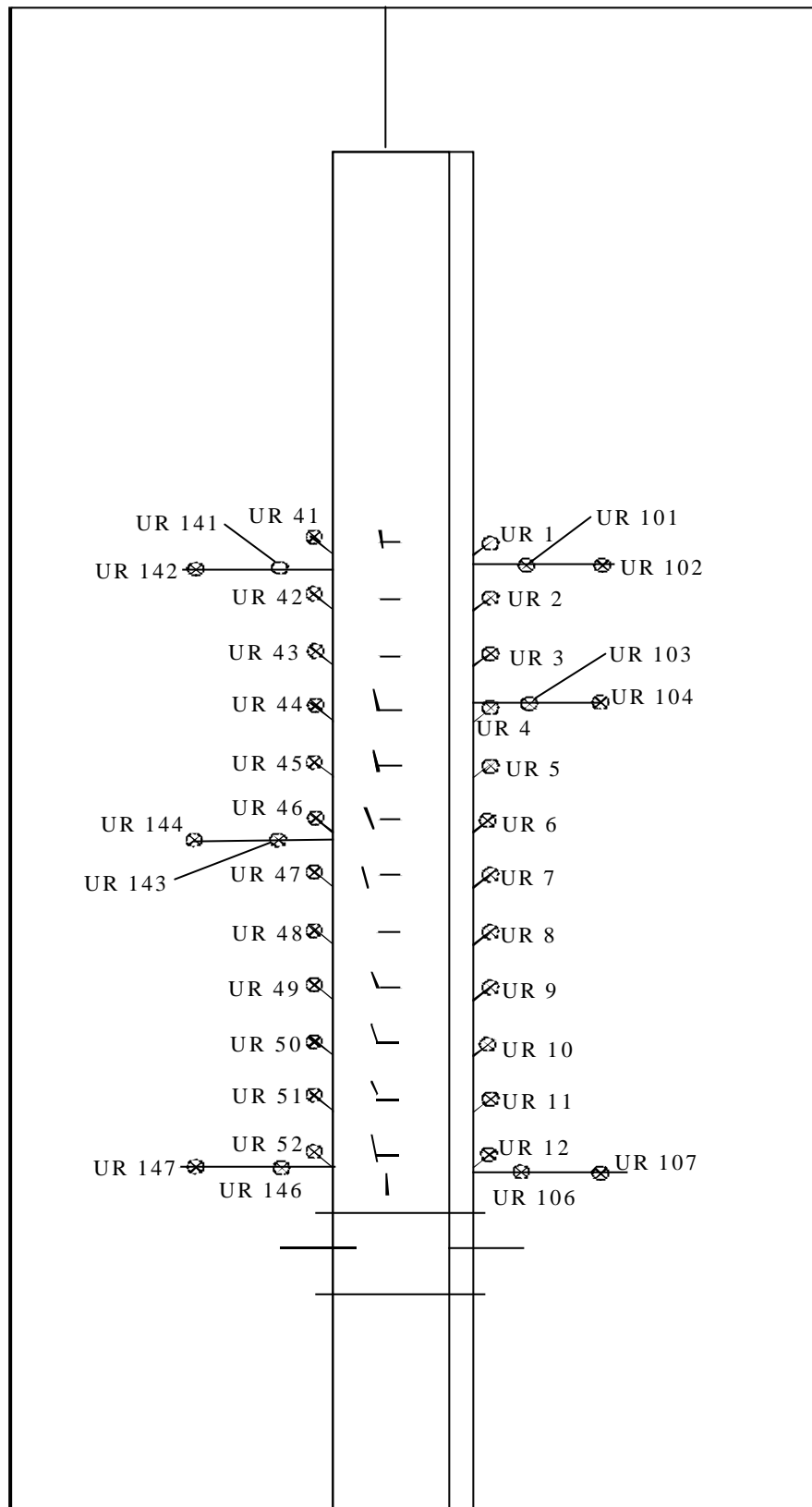

Figure 5-1. Position of measuring points in the boreholes of the rock in the floor (left part) and the roof. Vertical section.

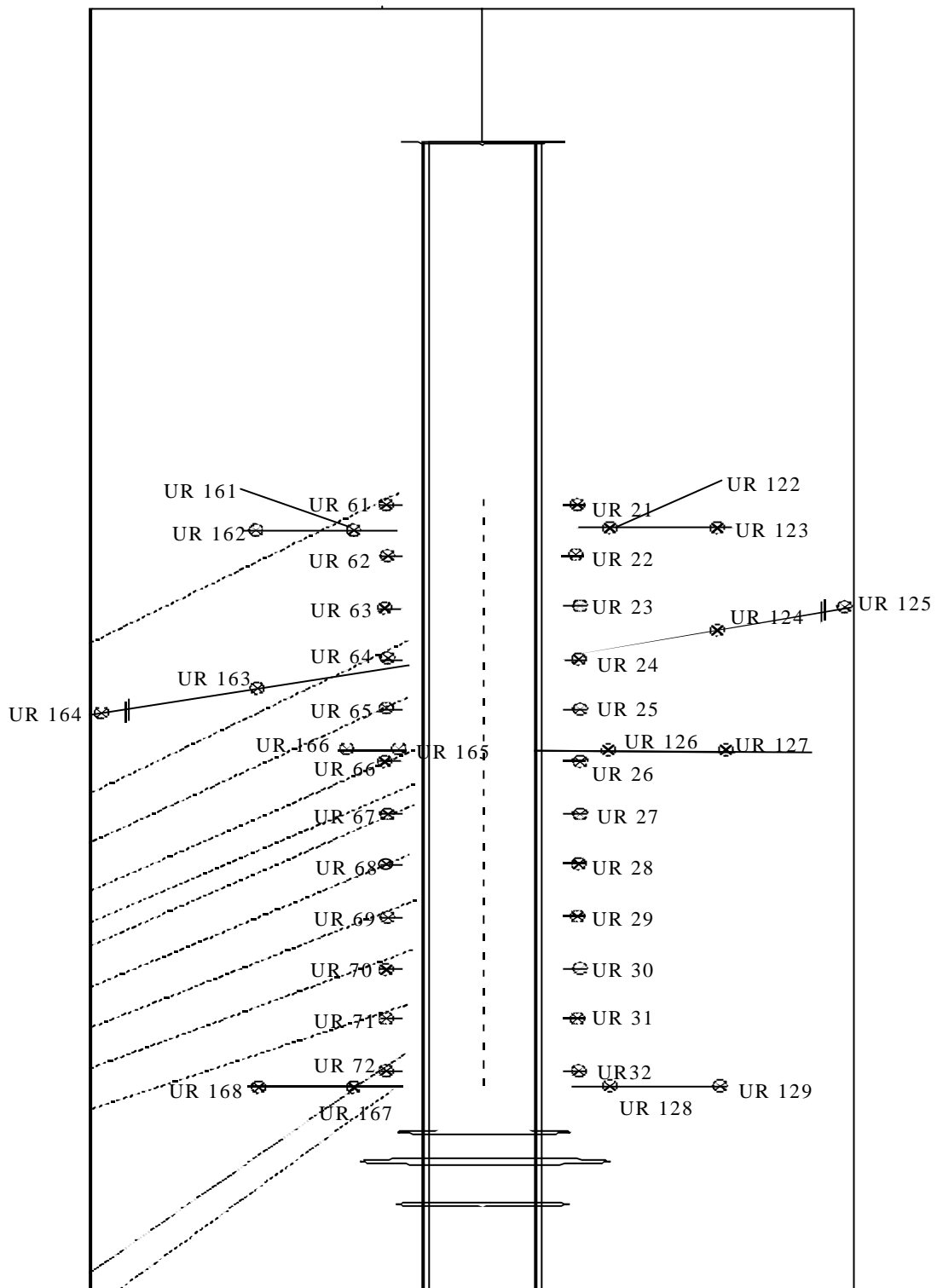
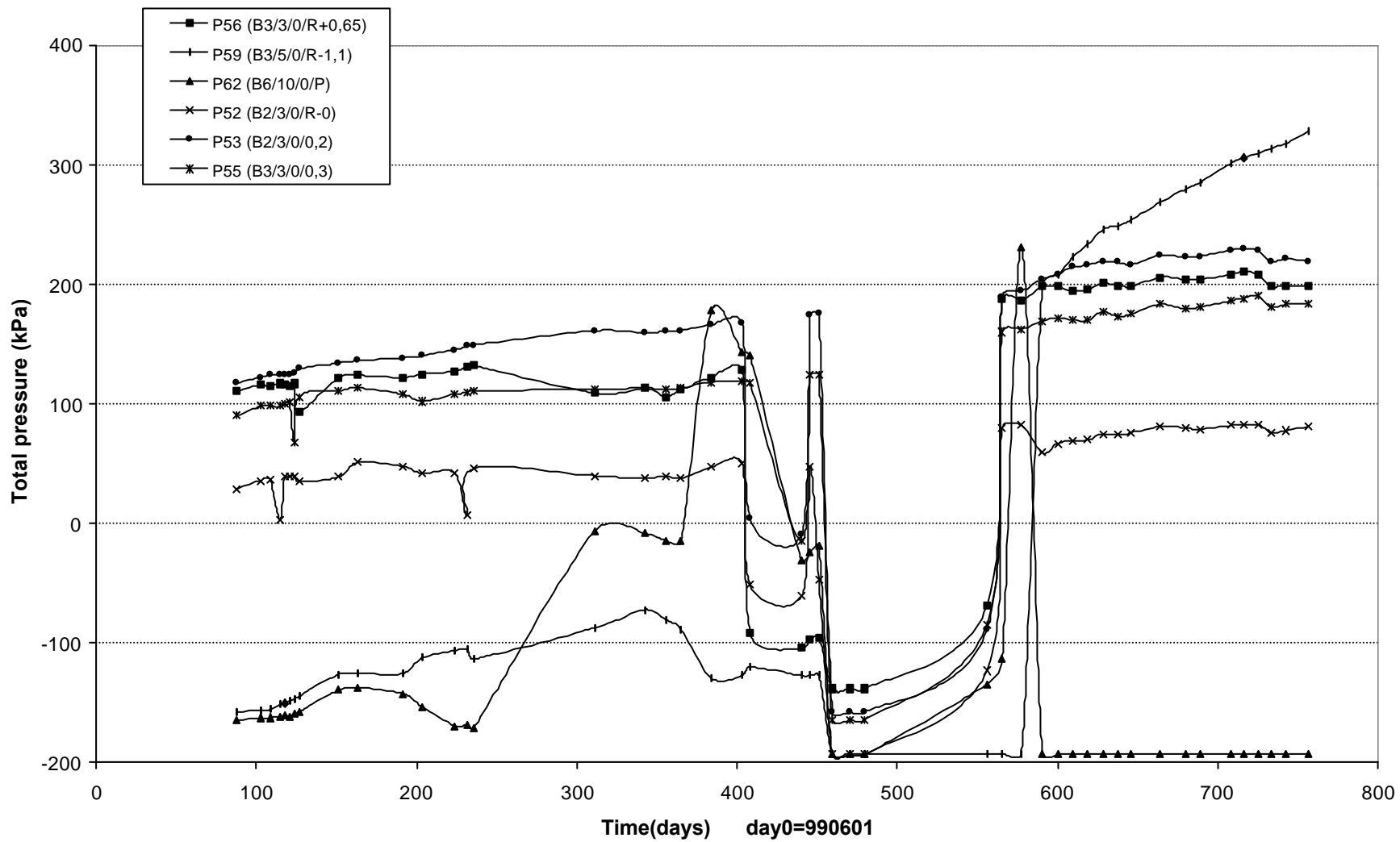
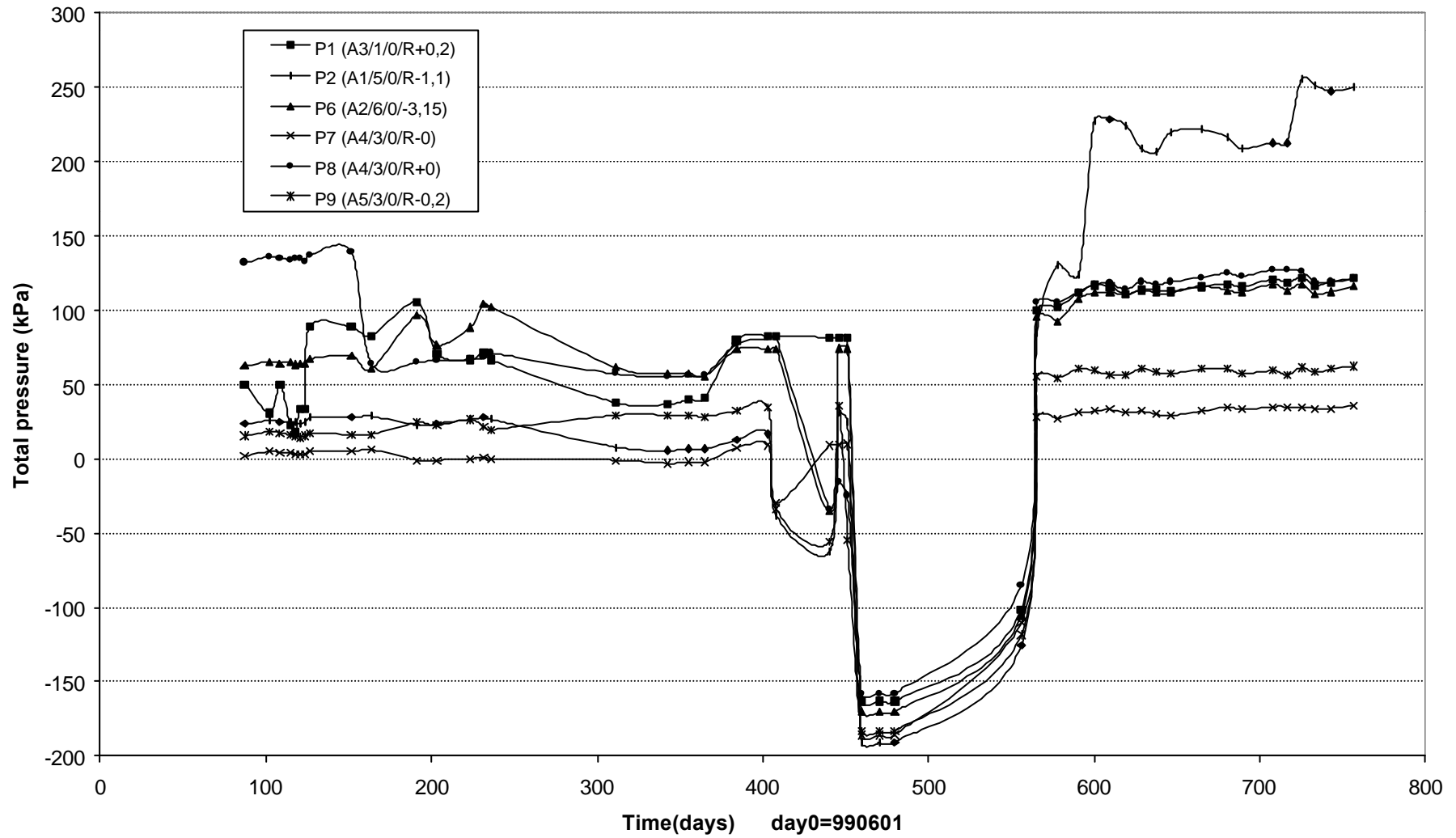

Figure 5-2. Position of measuring points in the boreholes of the rock in the walls. Horizontal section

**Total pressure sections B2-B6 (990601-010701)
GLÖTZL**



**Total pressure sections A1-A5 (990601-010701)
GLÖTZL**



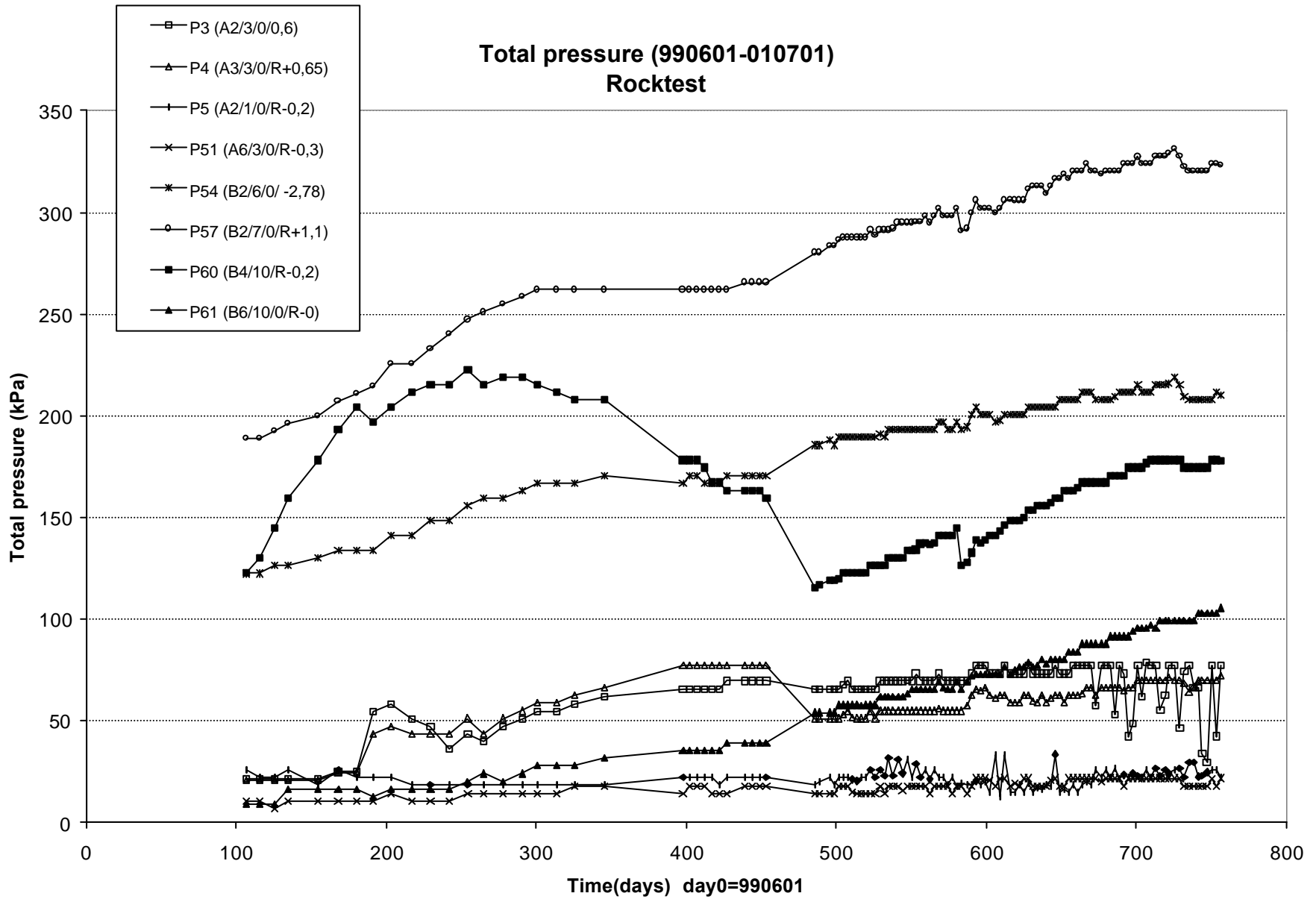

Suction in backfill sections A1&A2 (990601-010701)
WESCOR

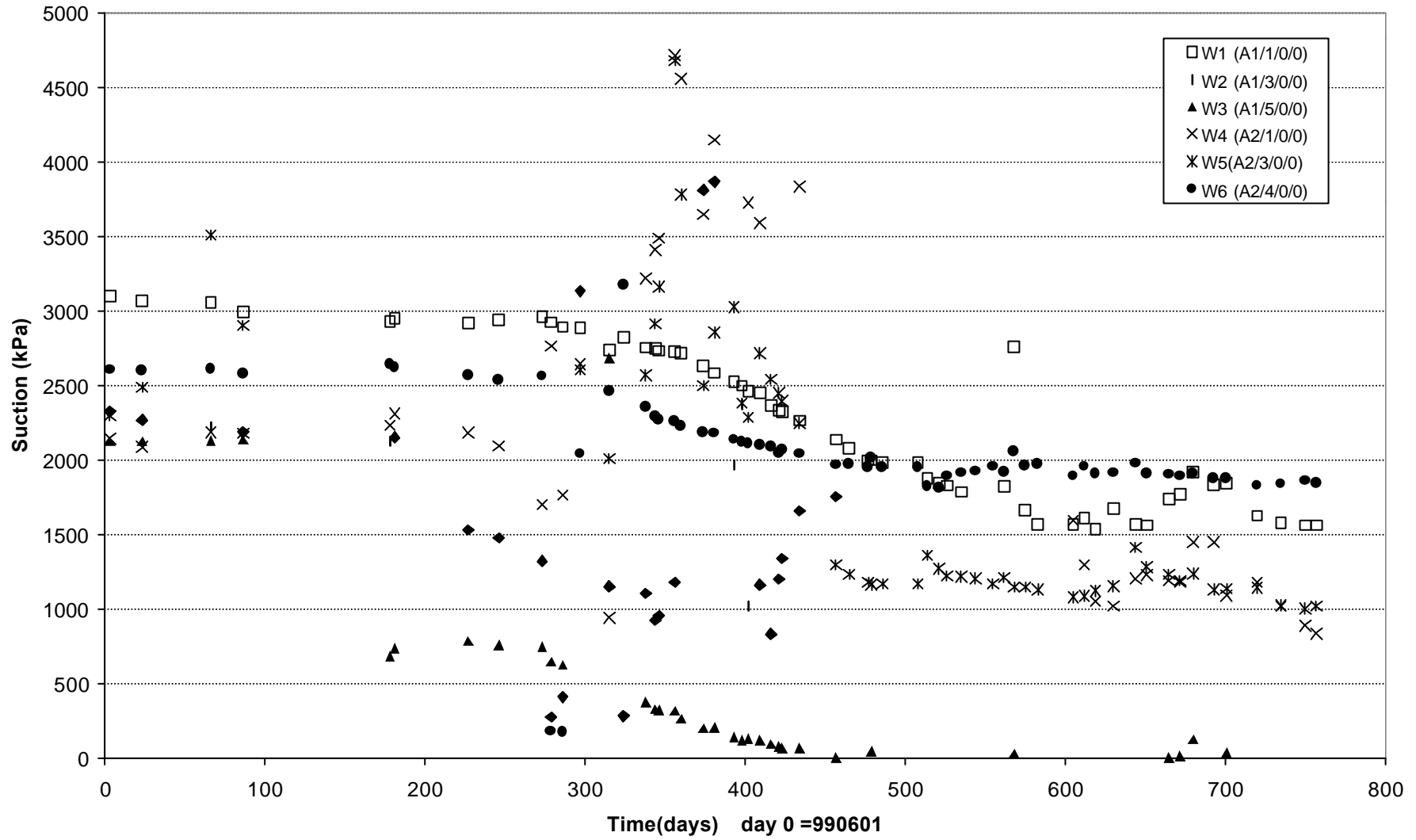

Suction in backfill section A3 (990601-010701)
WESCOR

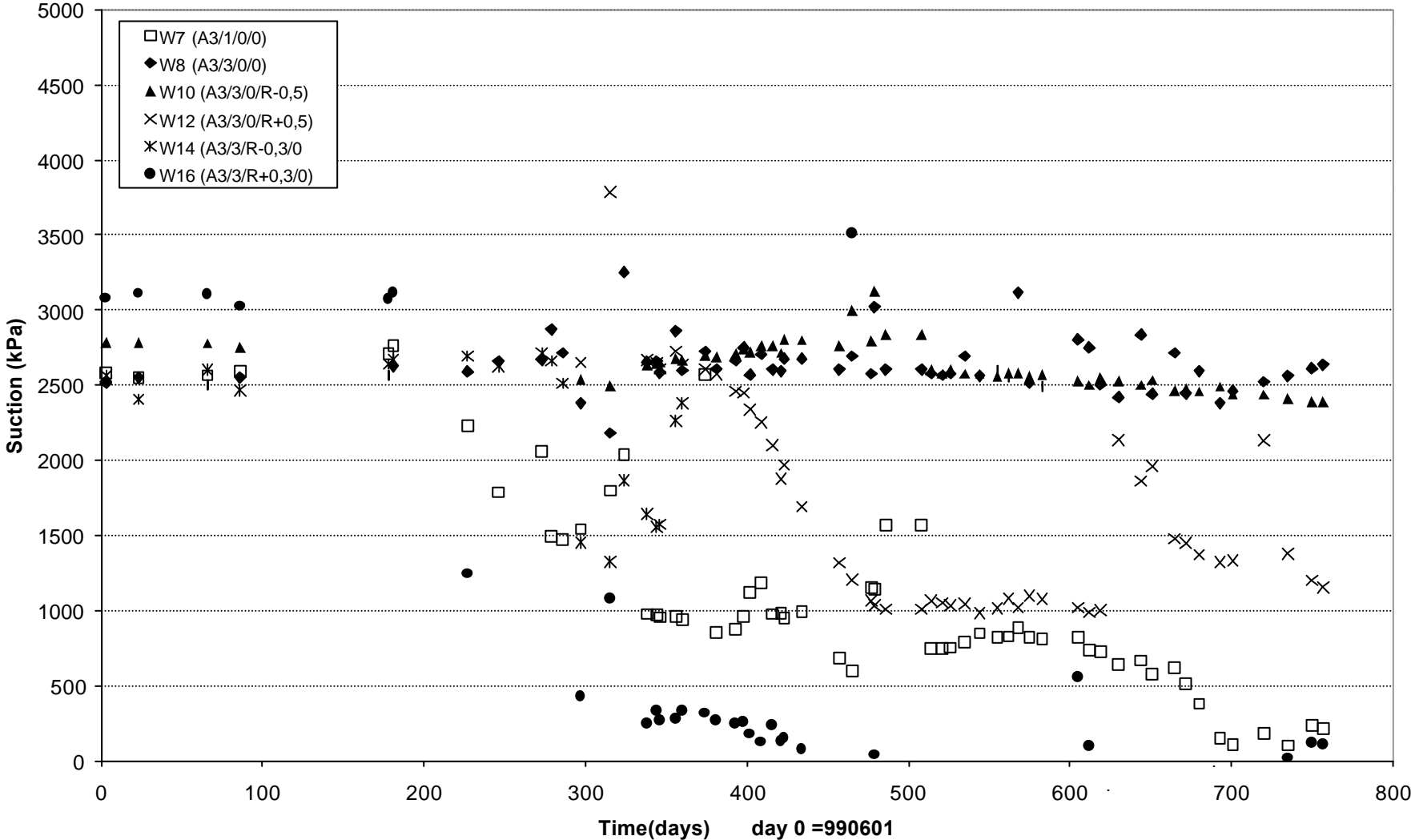

Suction in backfill sections A4&A5 (990601-010701)
WESCOR

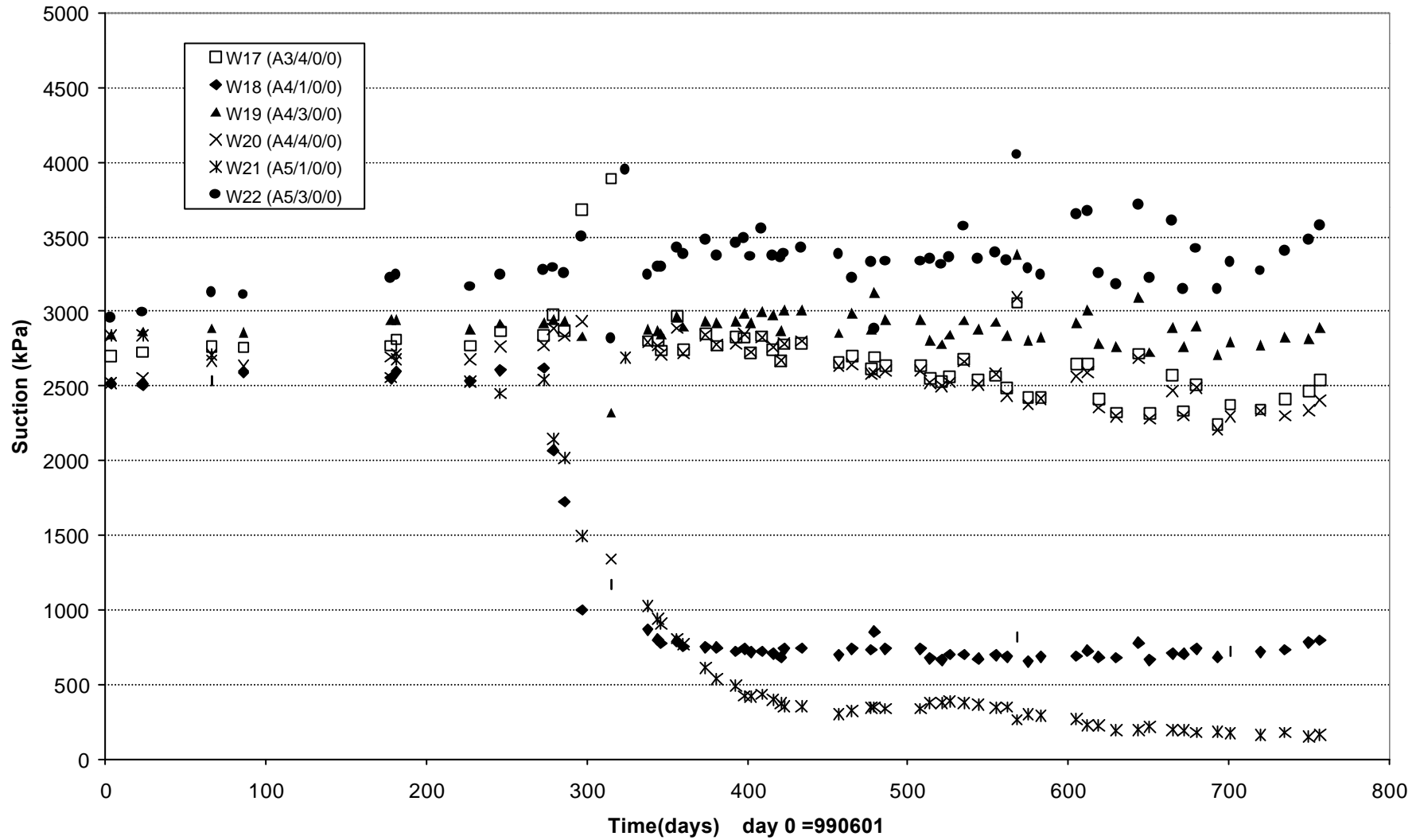

Suction in backfill sections A5&A6 (990601-010701)
WESCOR

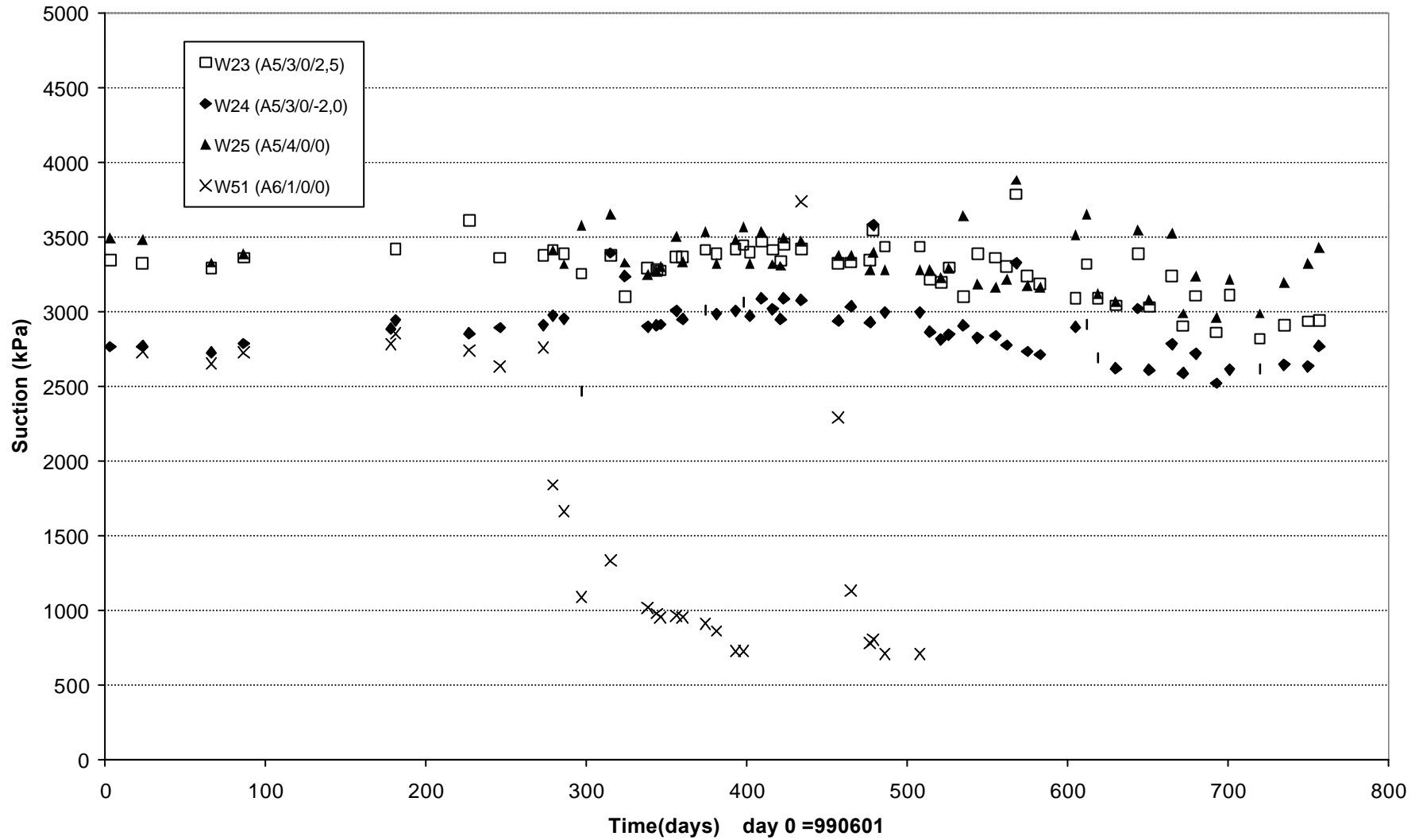

Resistivity in backfill sections B3, B4&B5 (990601-010701)
LTH-probe

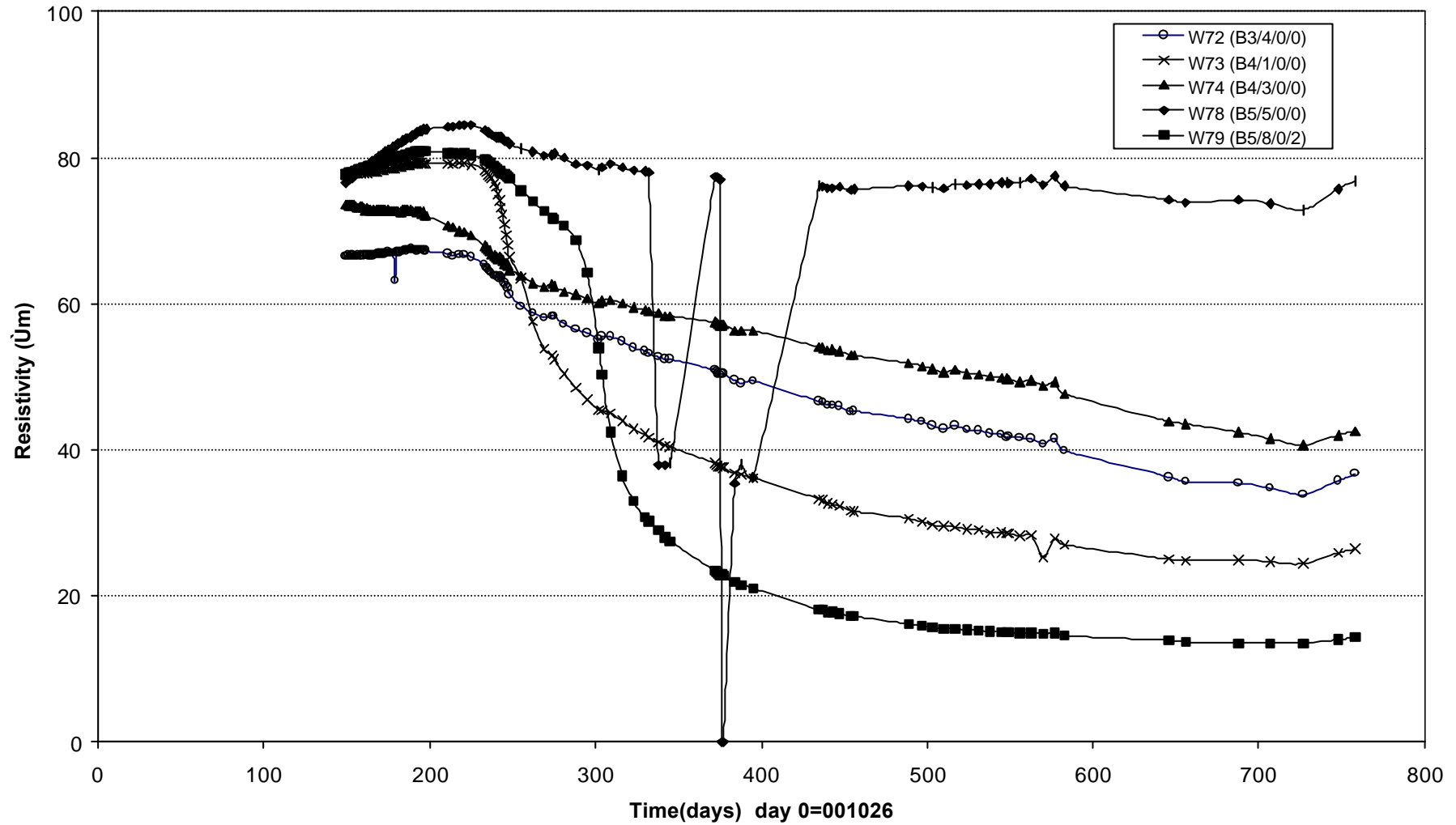

Resistivity in backfill sections B2,B3 (990601-010701)
LTH-probe

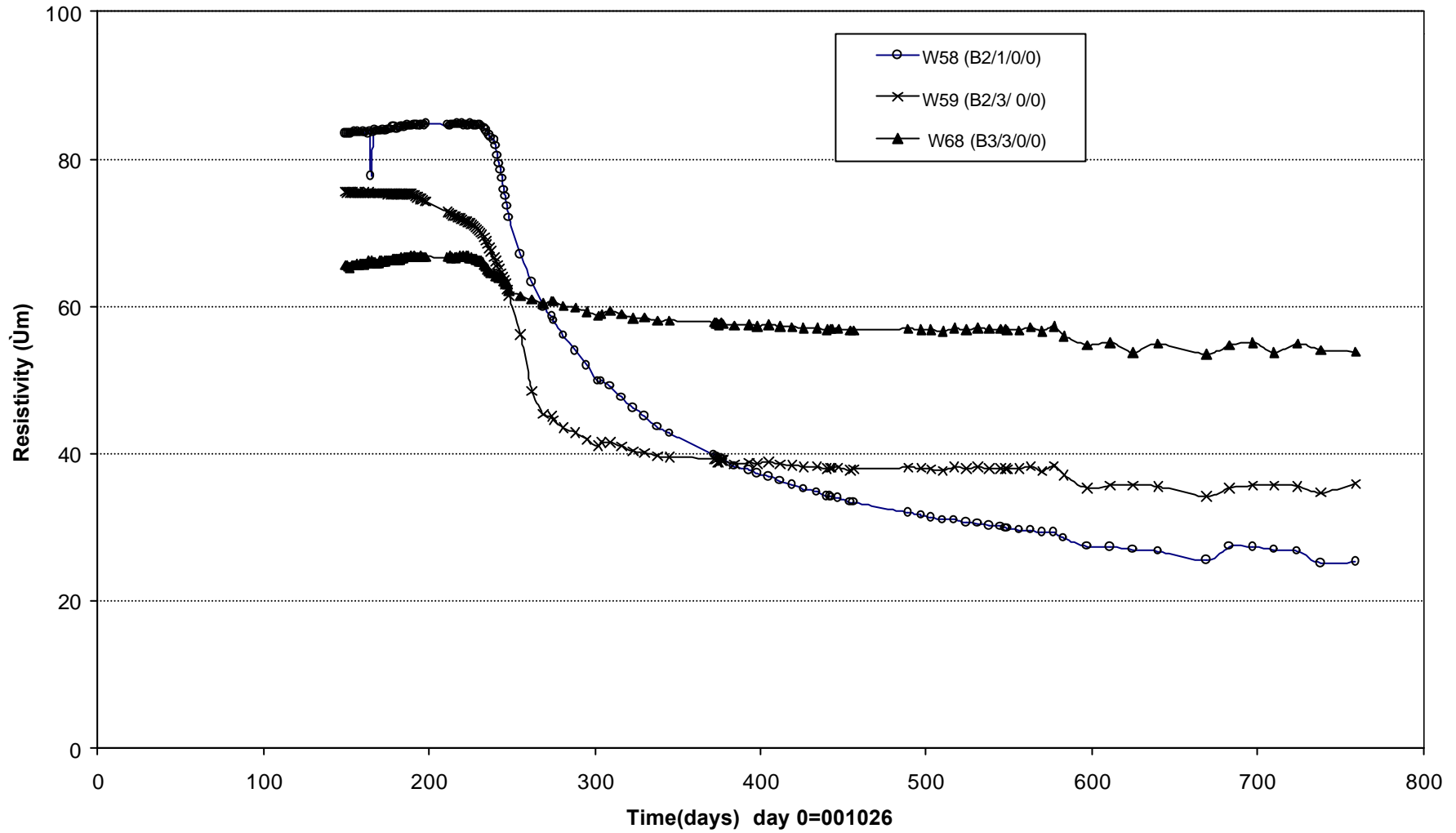

Pore water pressure section A1(990601-010701)
GLÖTZL

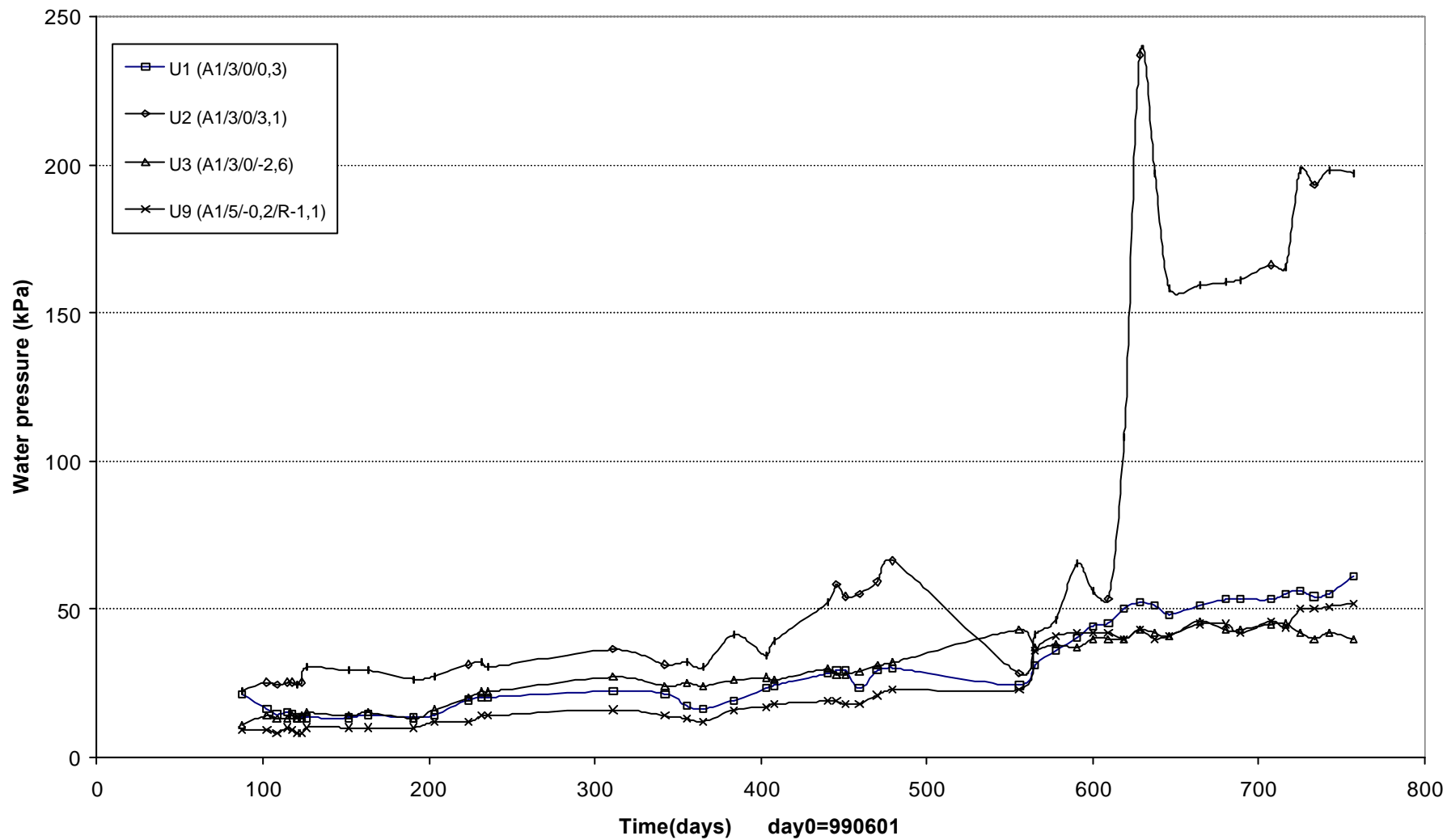

Pore water pressure section A2(990601-010701)
GLÖTZL

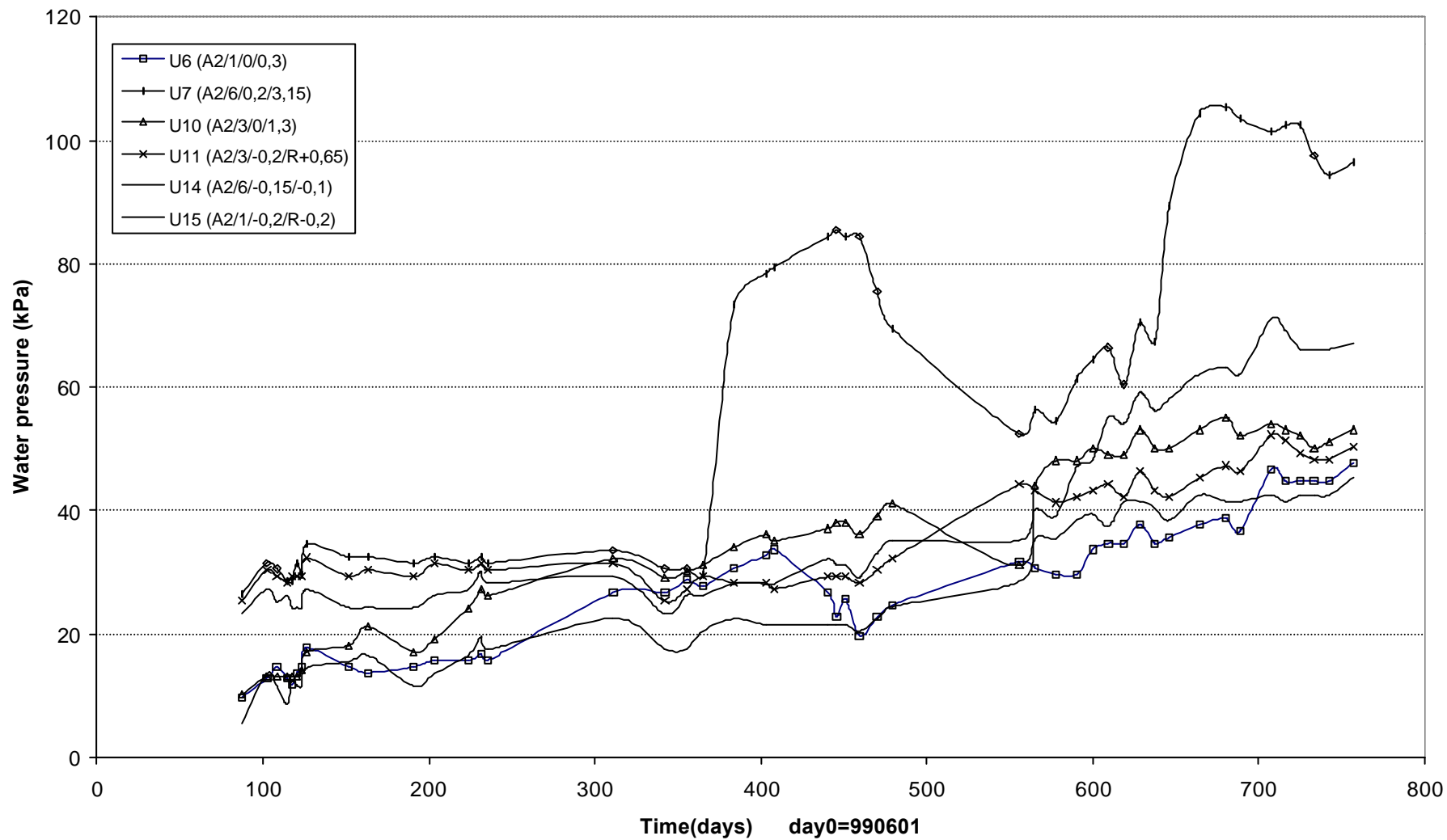

Pore water pressure section A3&A4(990601-010701)
GLÖTZL

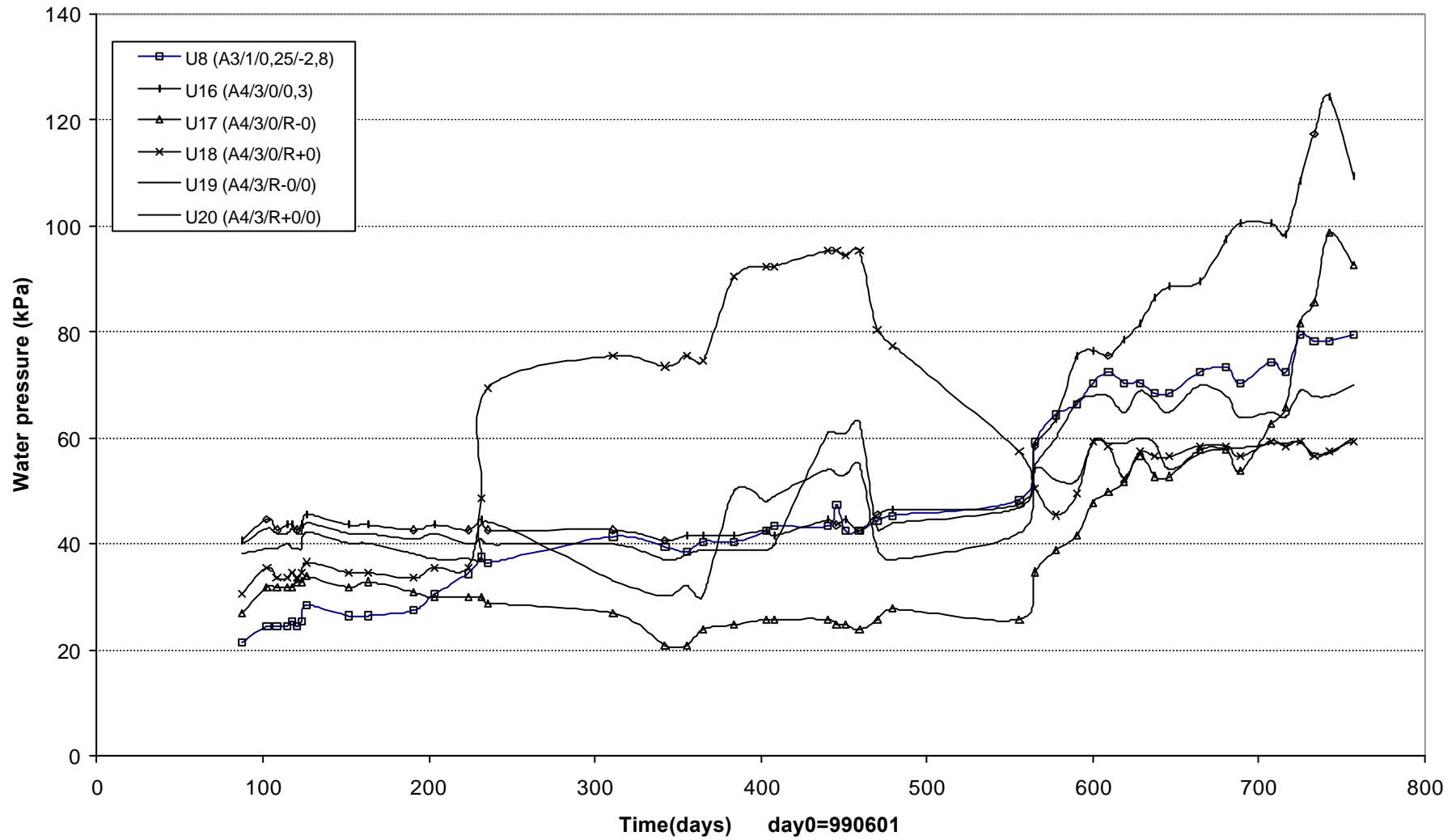

Pore water pressure section A5(990601-010701)
GLÖTZL

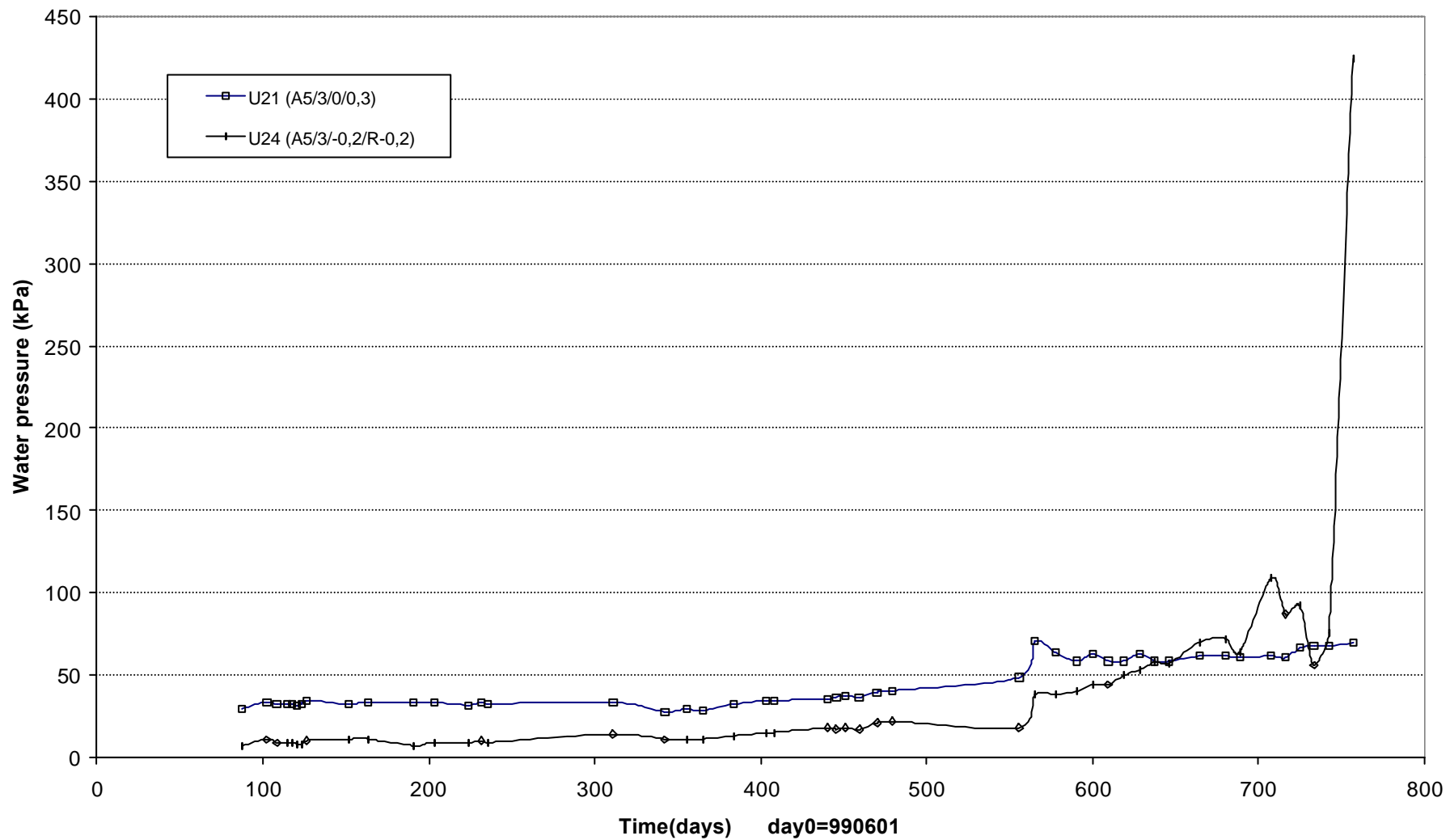

Water pressure in backfill sections A1&A2 (990601-010701)
DRUCK

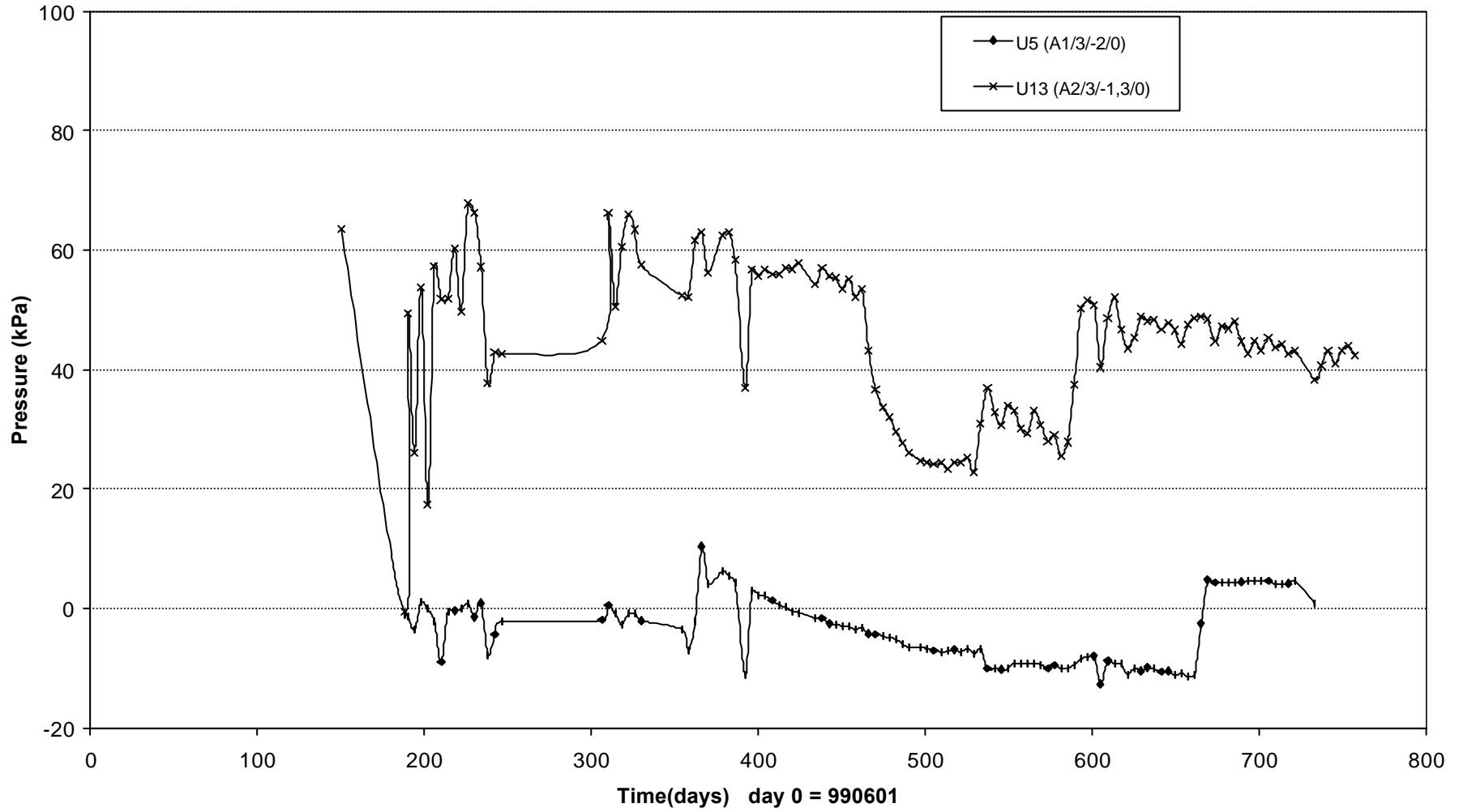

Water pressure in backfill sections B2&B3 (990601-010701)
DRUCK

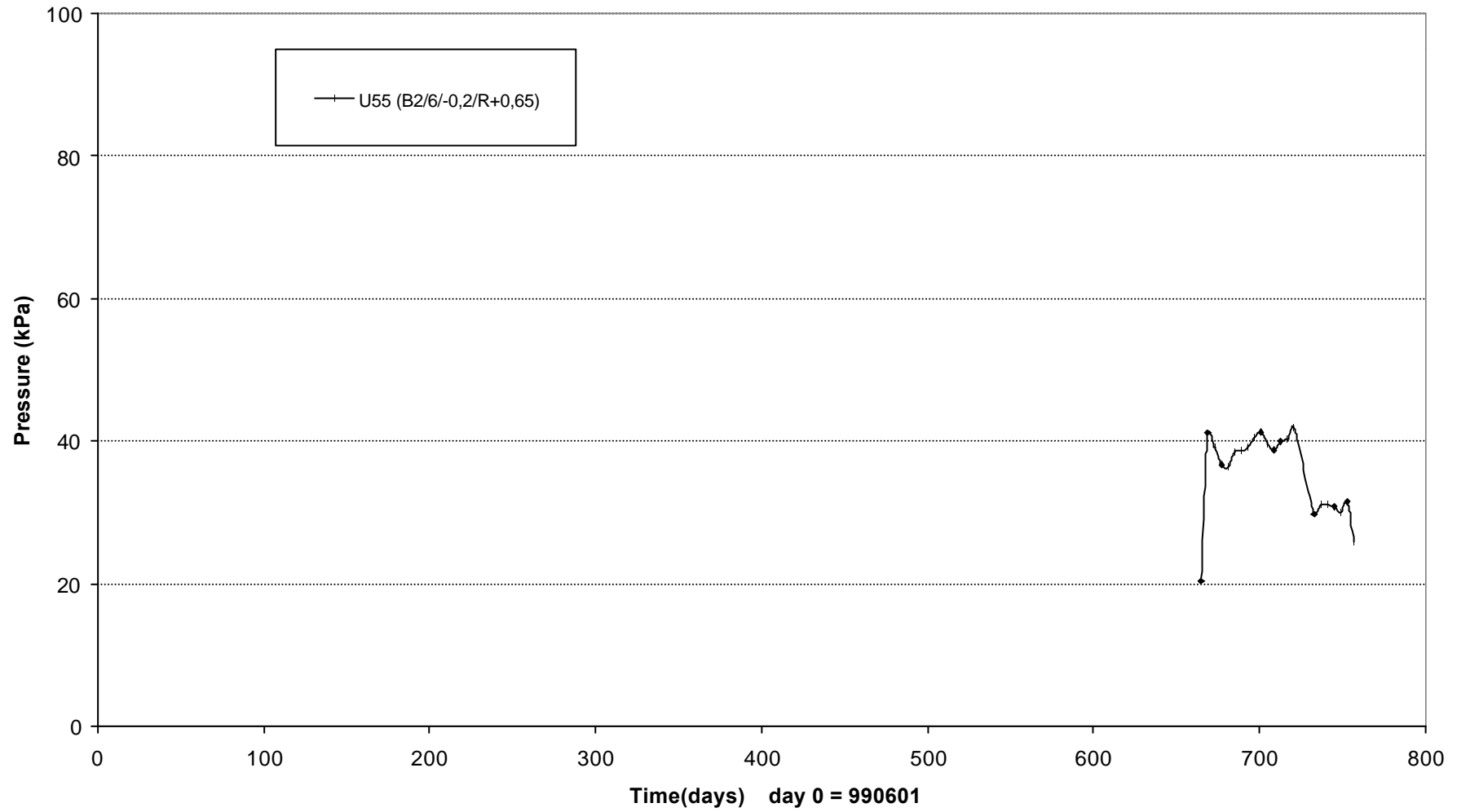

Water pressure in backfill sections B4&B6 (990601-010701)
DRUCK

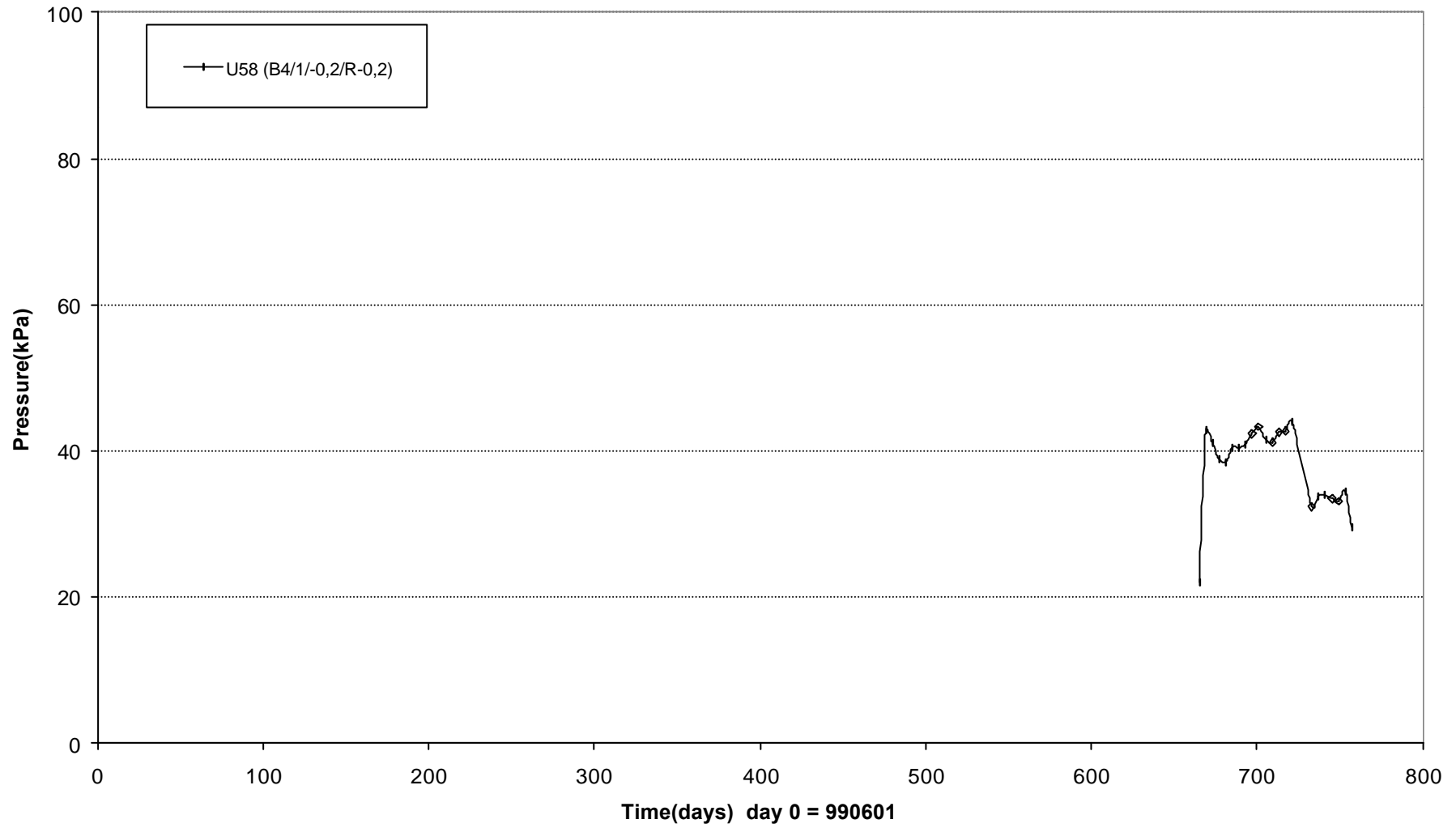

Flowmeter

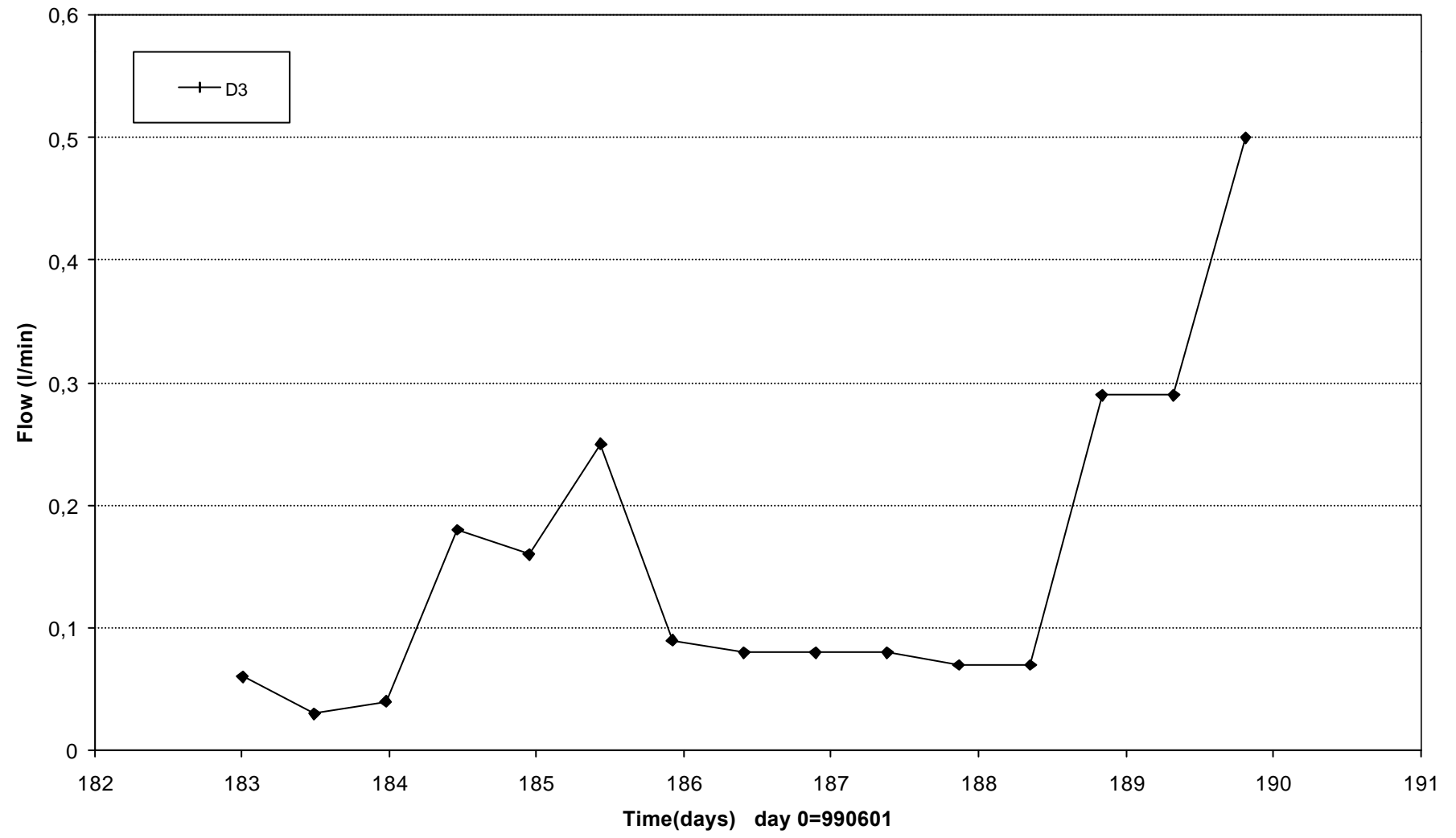

Flowmeter

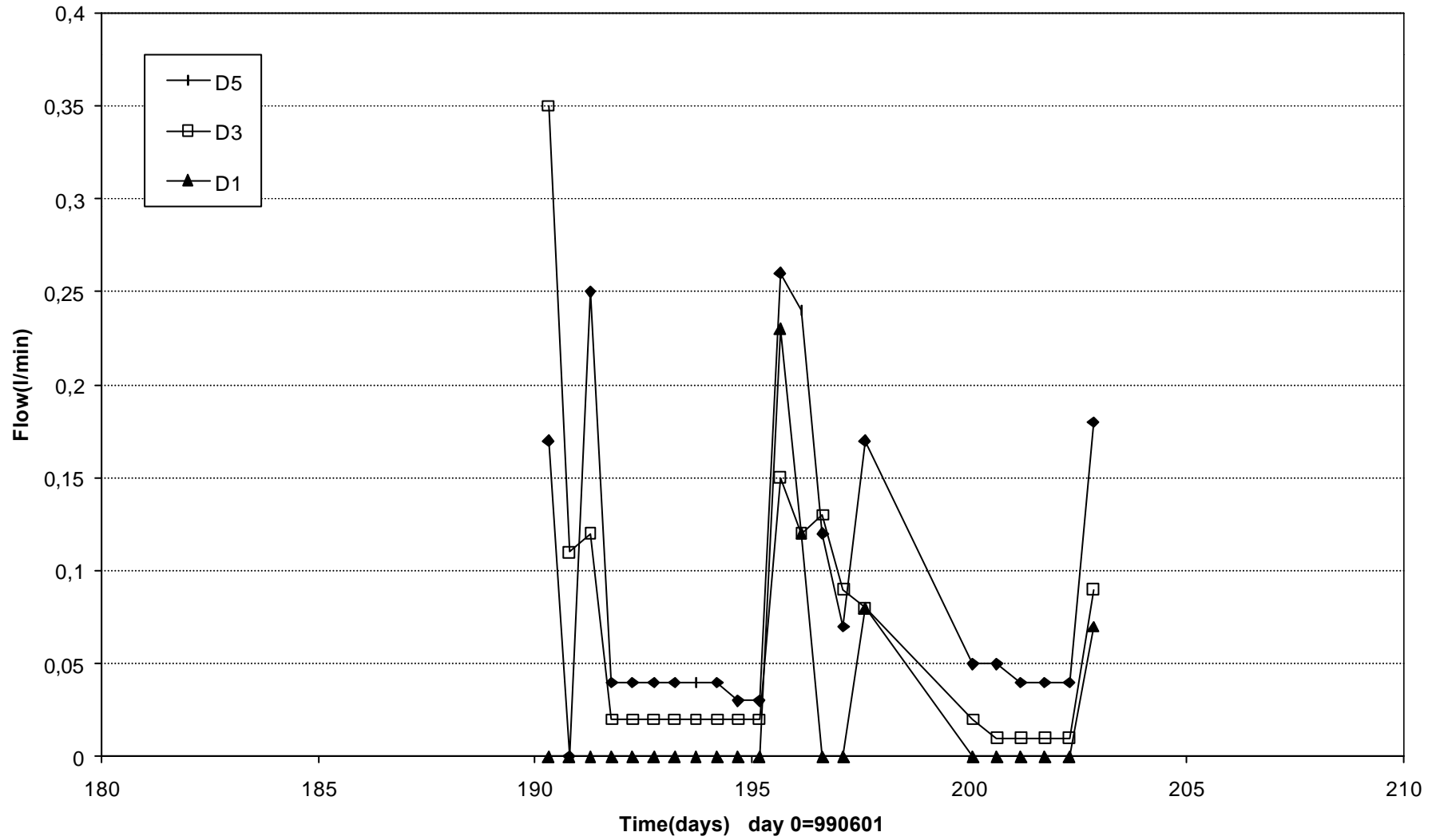

Flowmeter

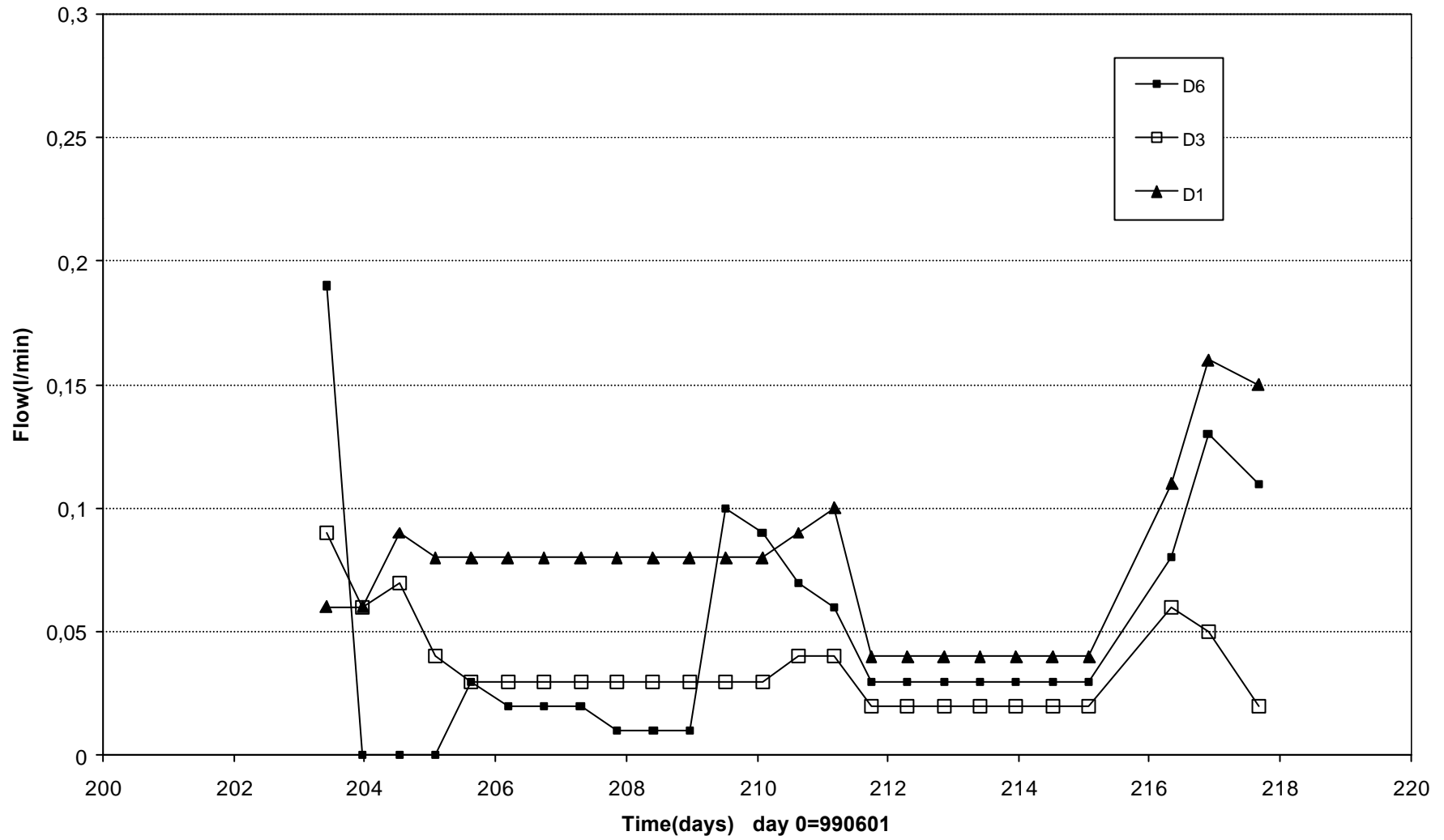

Flowmeter

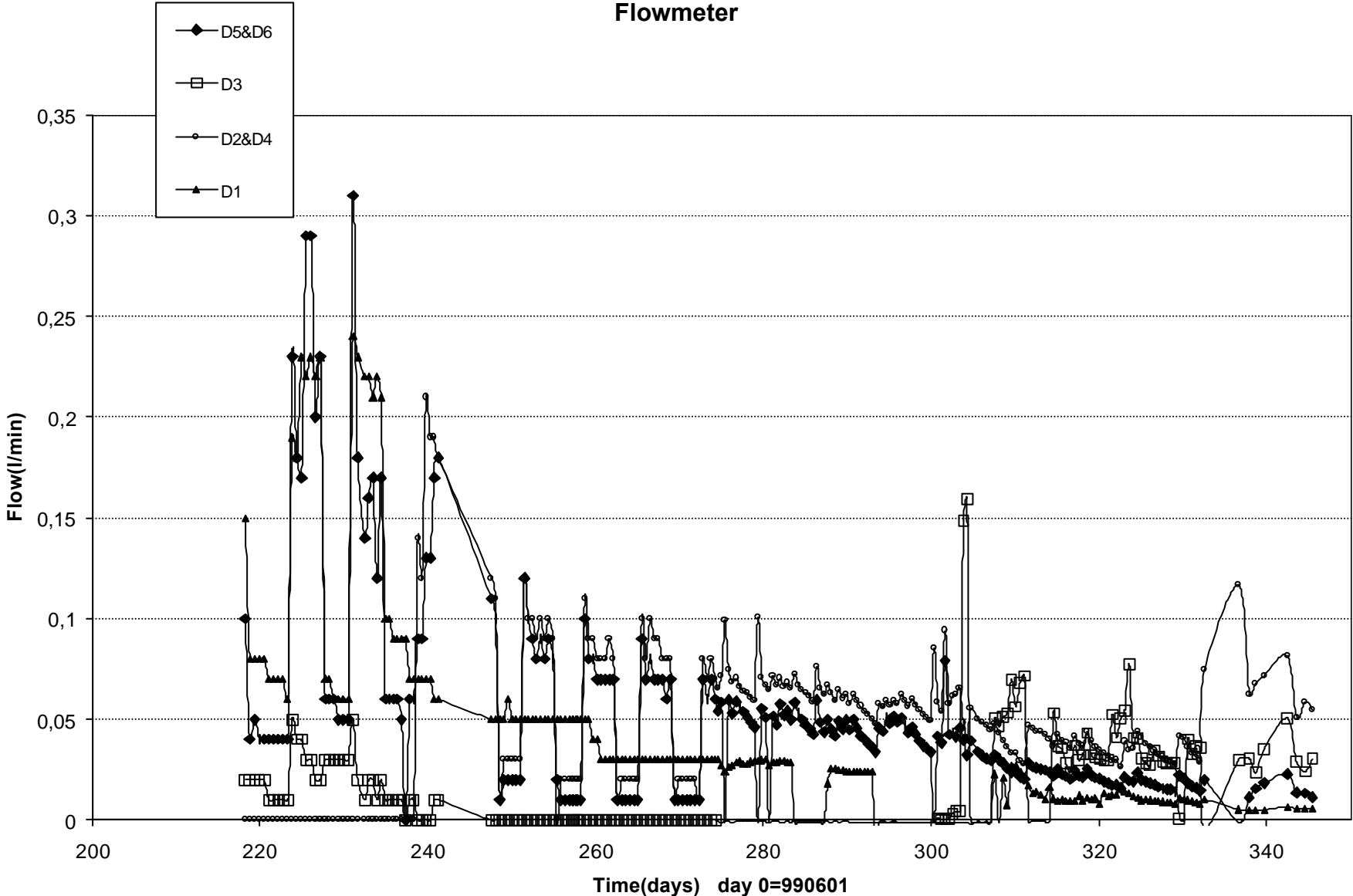

Flowmeter(000601-010701)

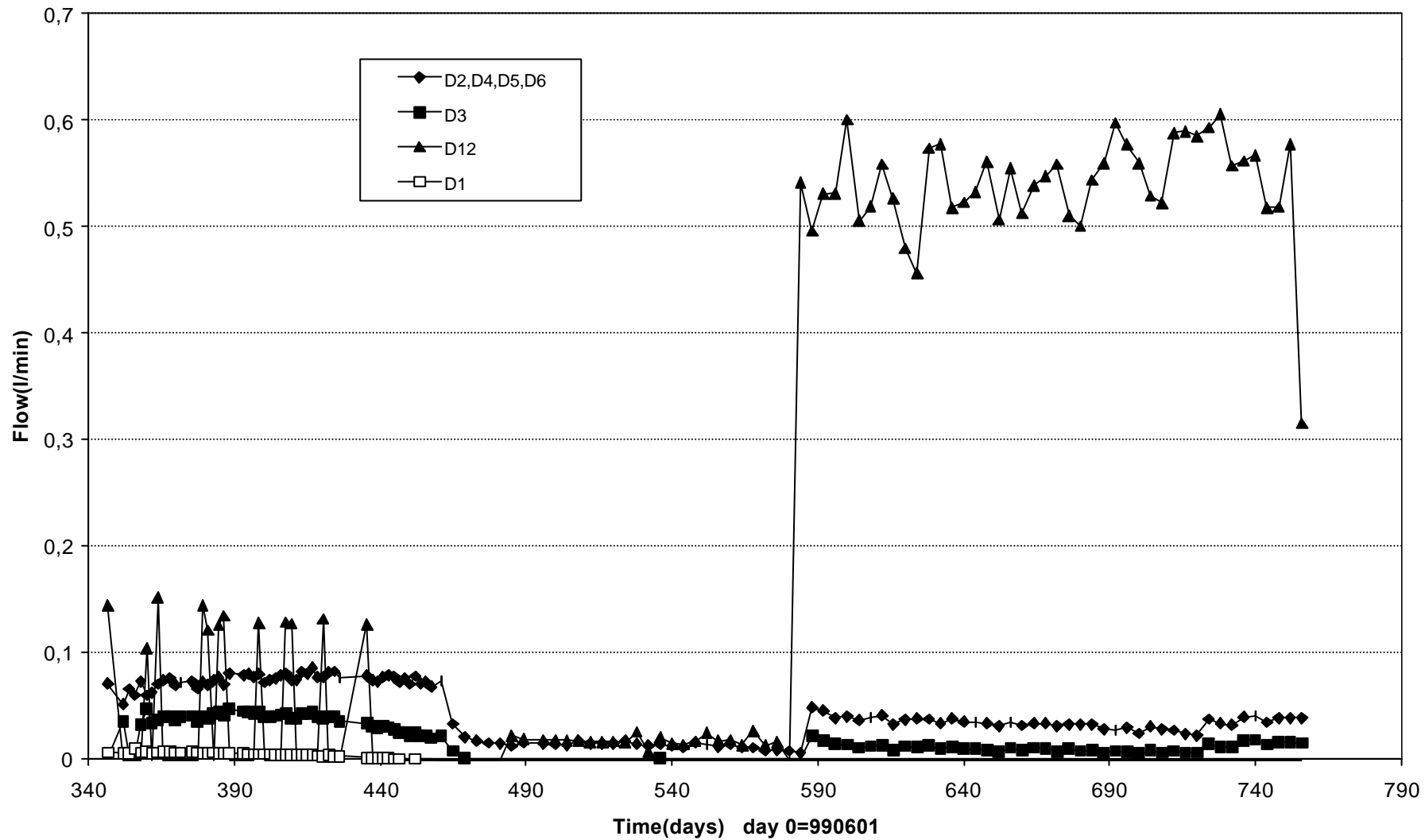

Water pressure in permeable mats D1-D6 (990601-010701)
Druck

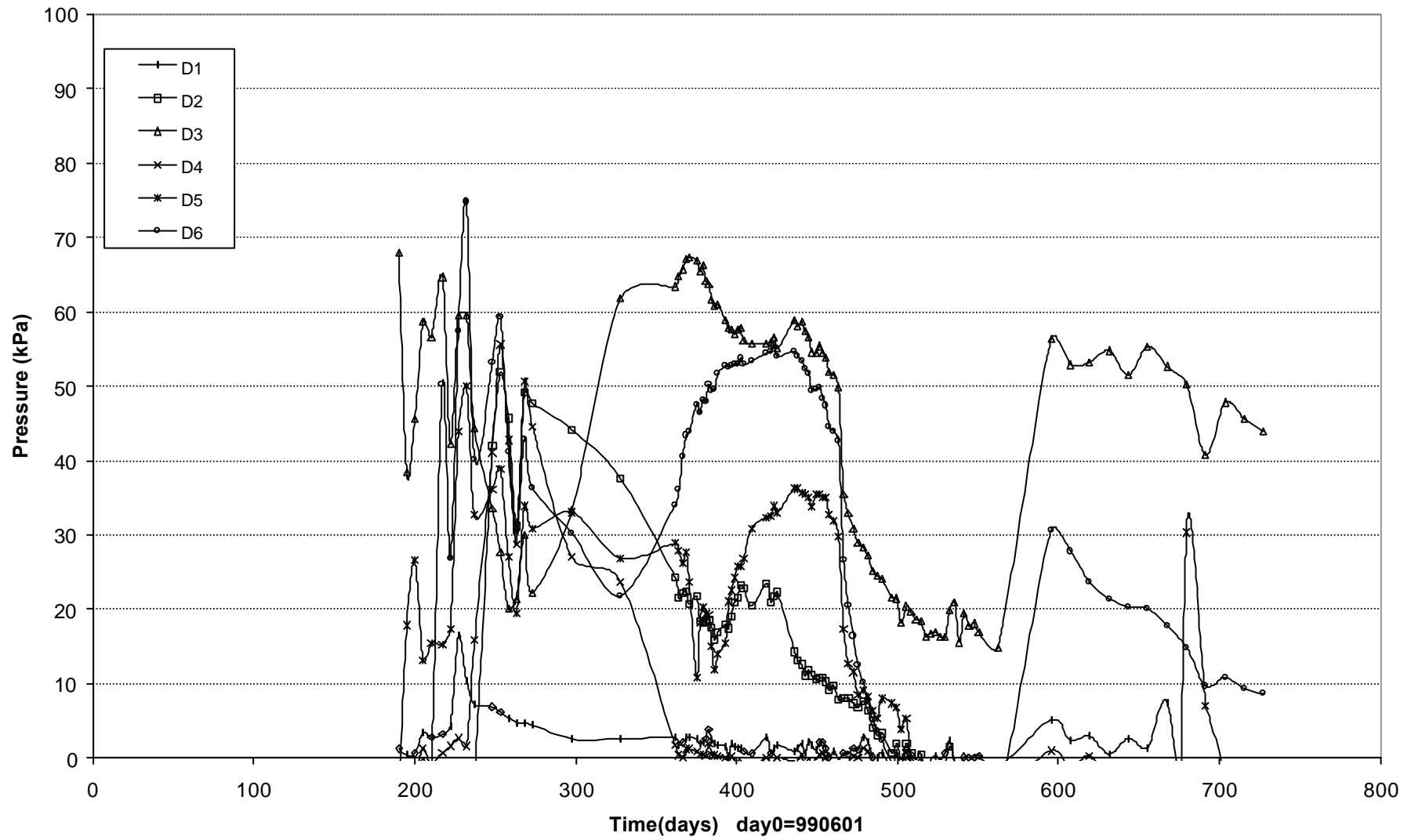

Water pressure in permeable mats D7-D12 (990601-010701)
DRUCK

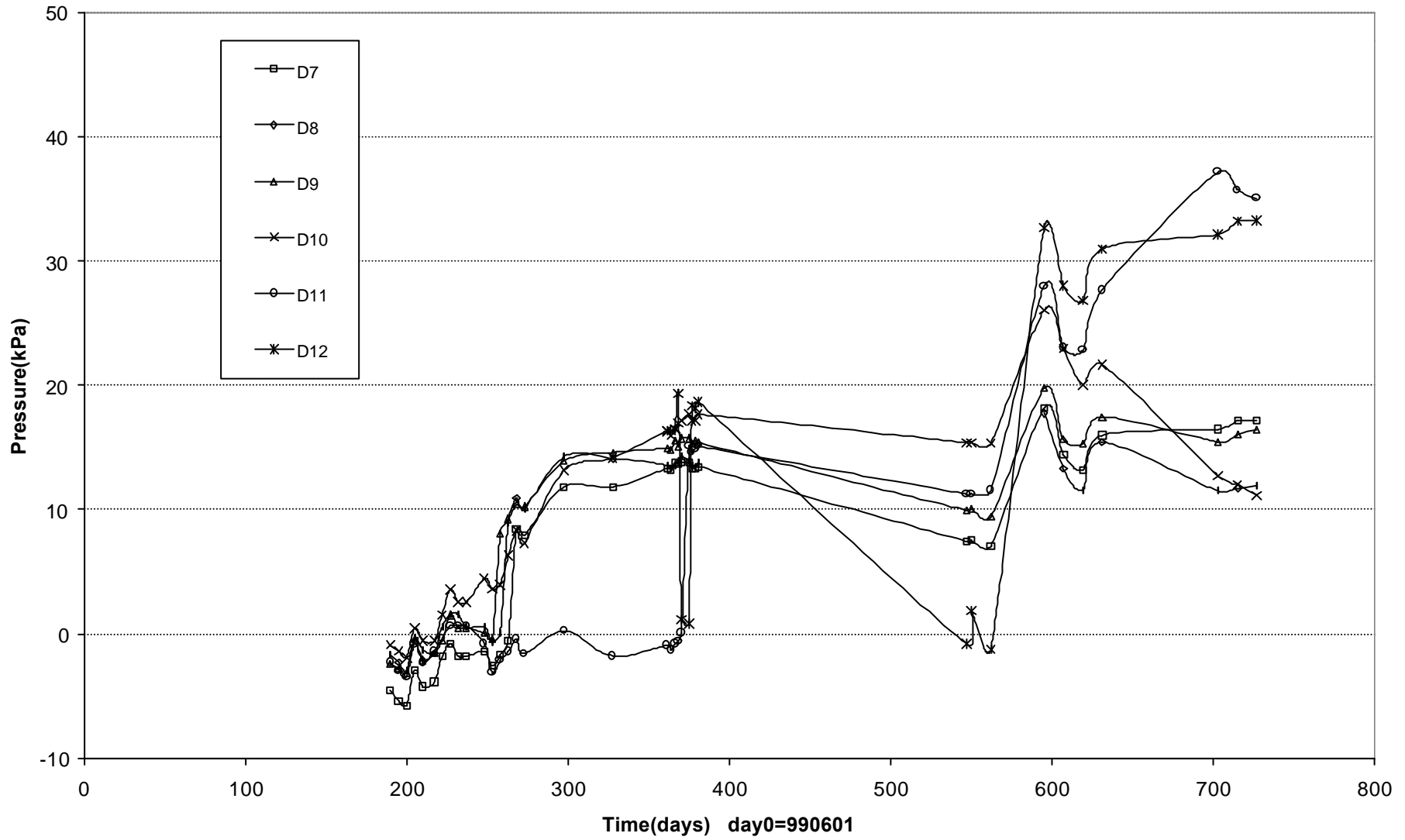

Water pressure in bore holes section 0 (990601-010701)
DRUCK

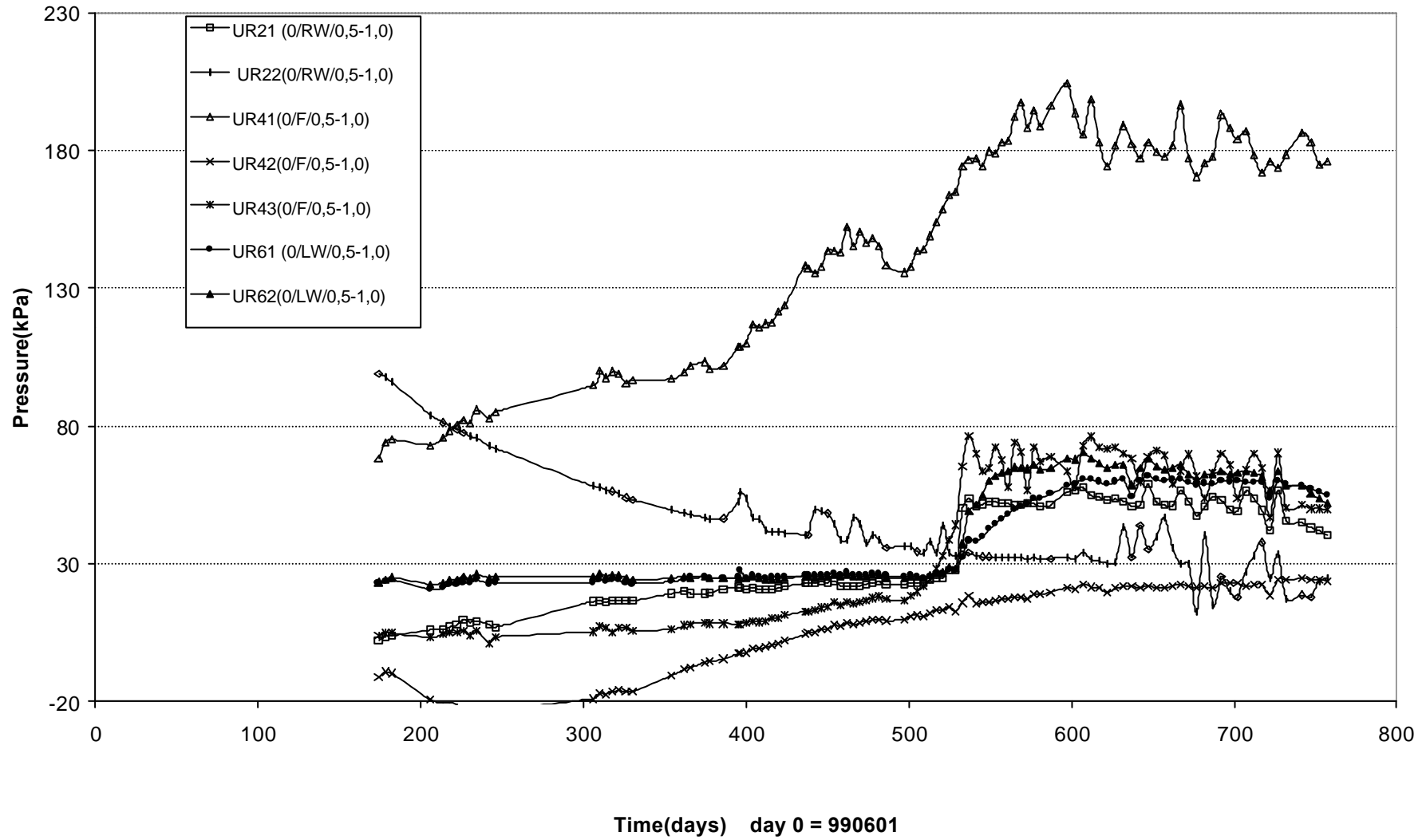

Water pressure in bore holes section 0 (990601-010701)
DRUCK

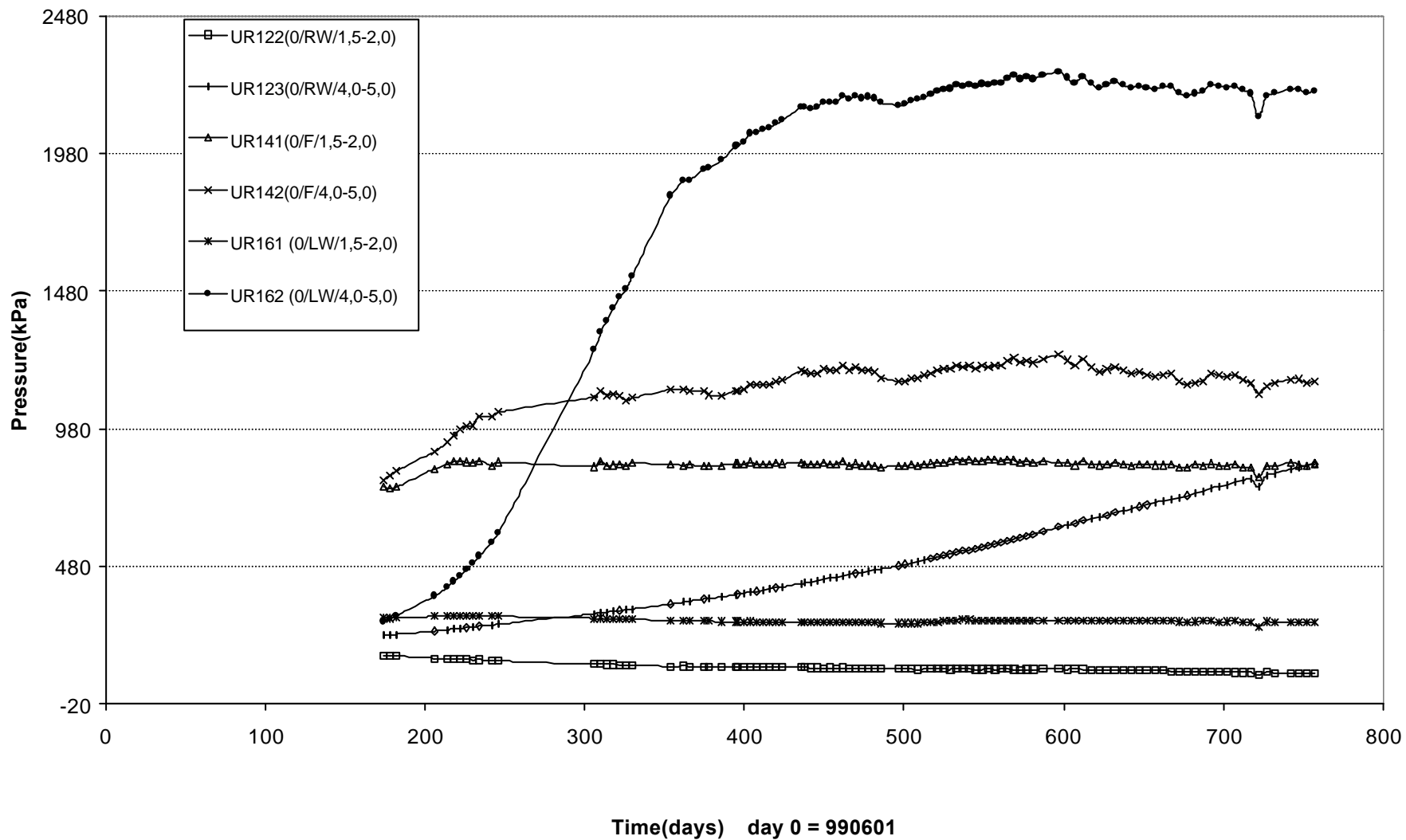

Water pressure in bore holes section A1 (990601-010701)
DRUCK

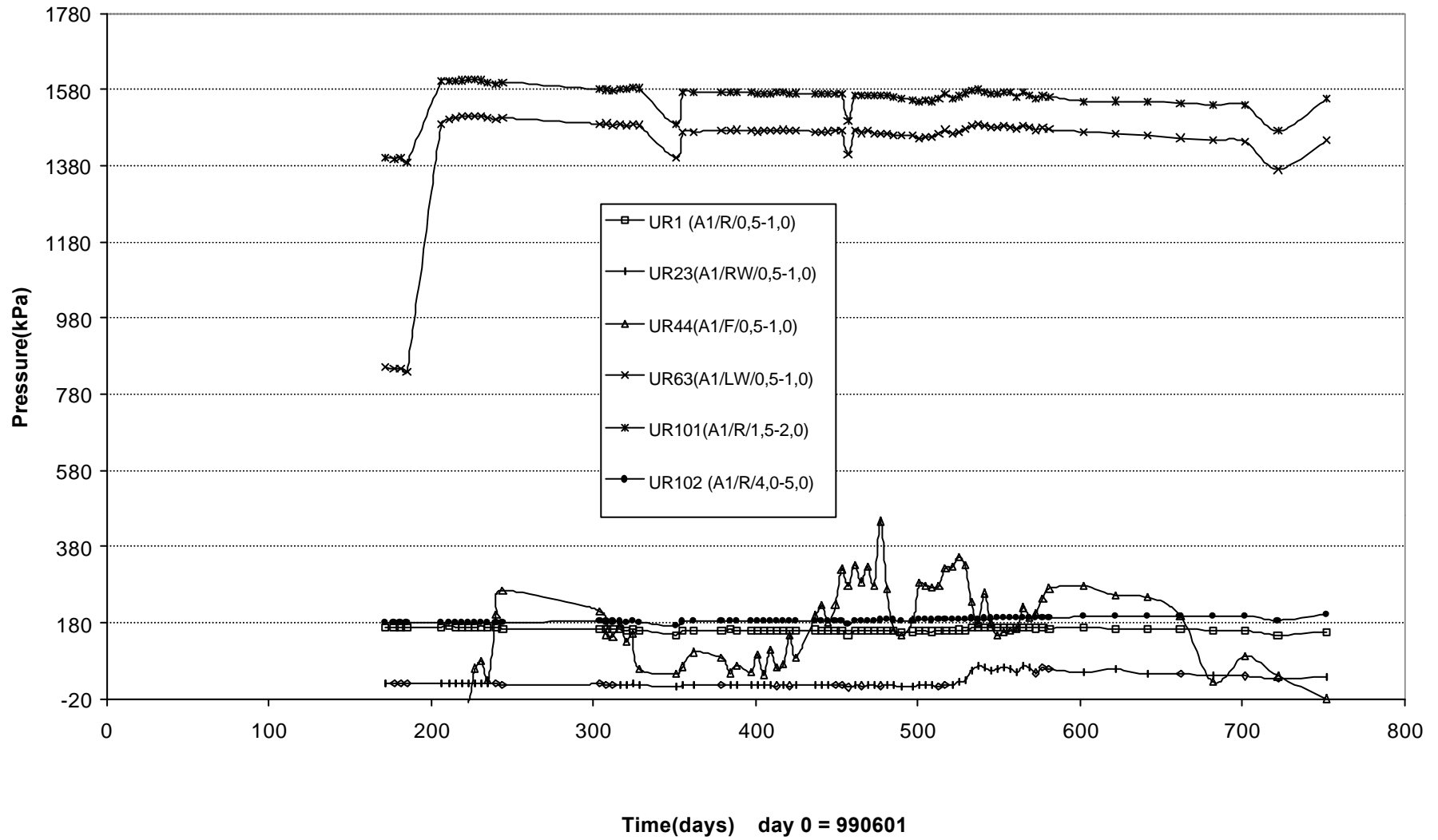

Water pressure in bore holes section A2 (990601-010701)
DRUCK

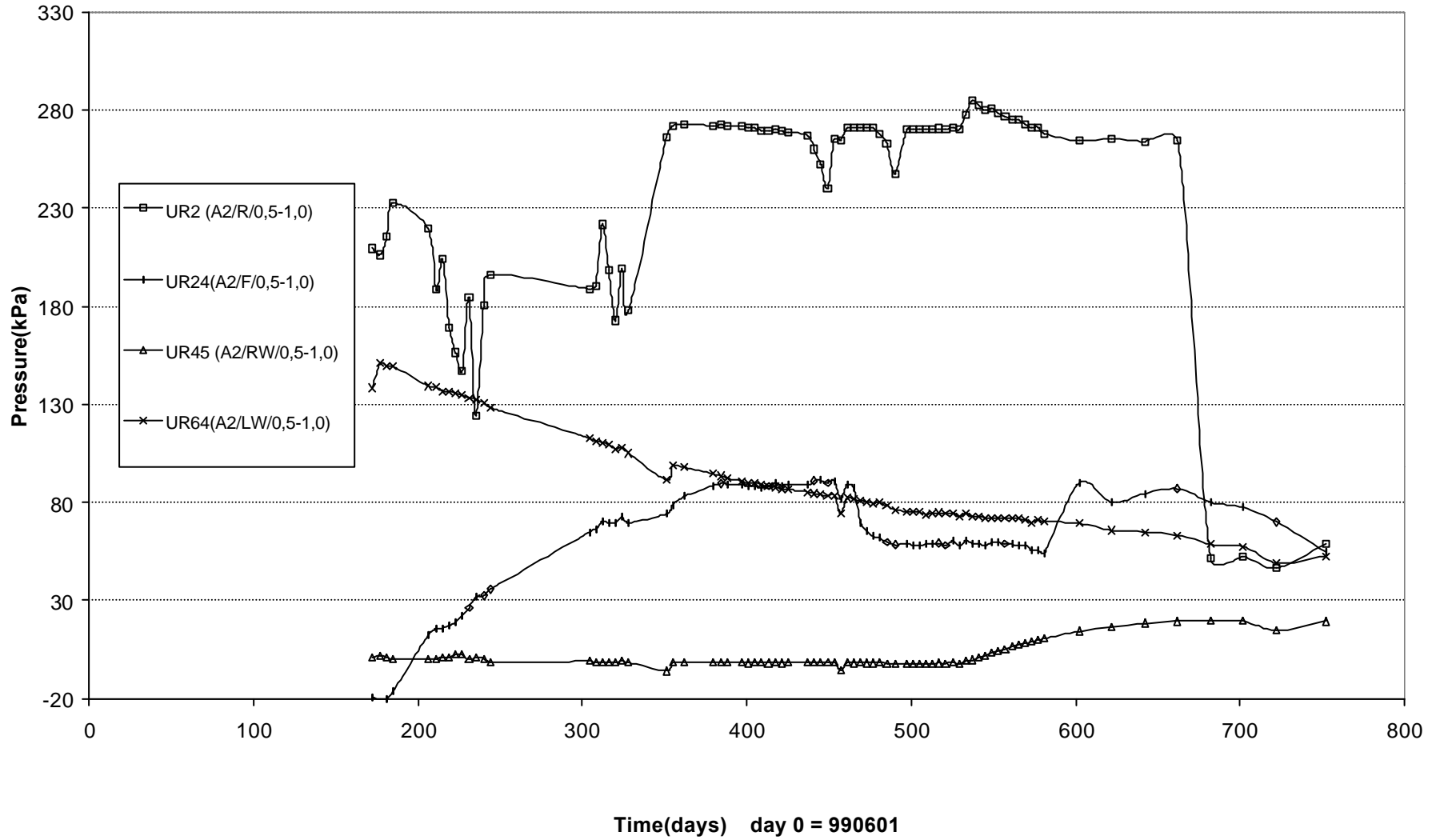

Water pressure in bore holes section A2 (990601-010701)
DRUCK

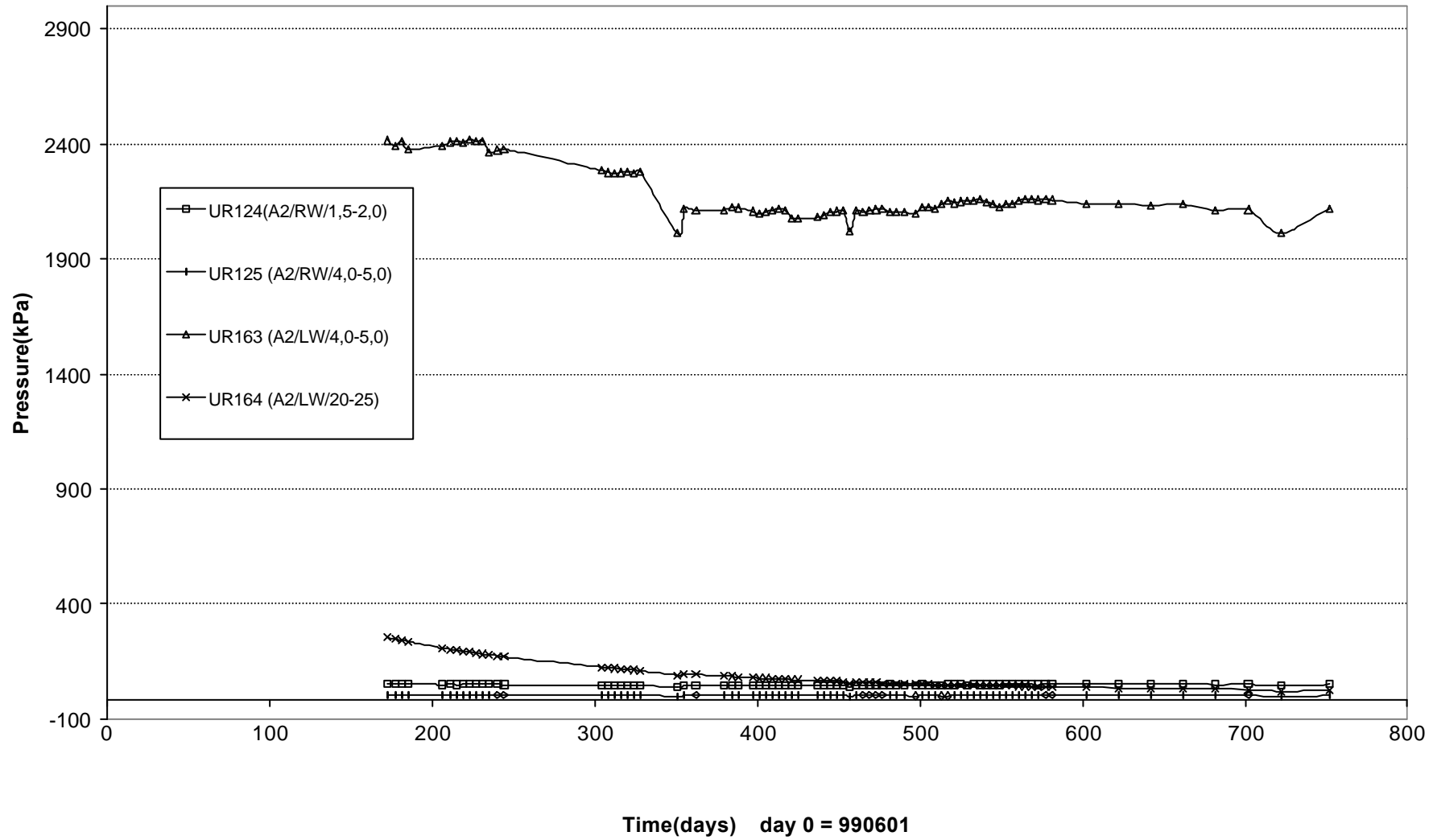

Water pressure in bore holes section A3 (990601-010701)
DRUCK

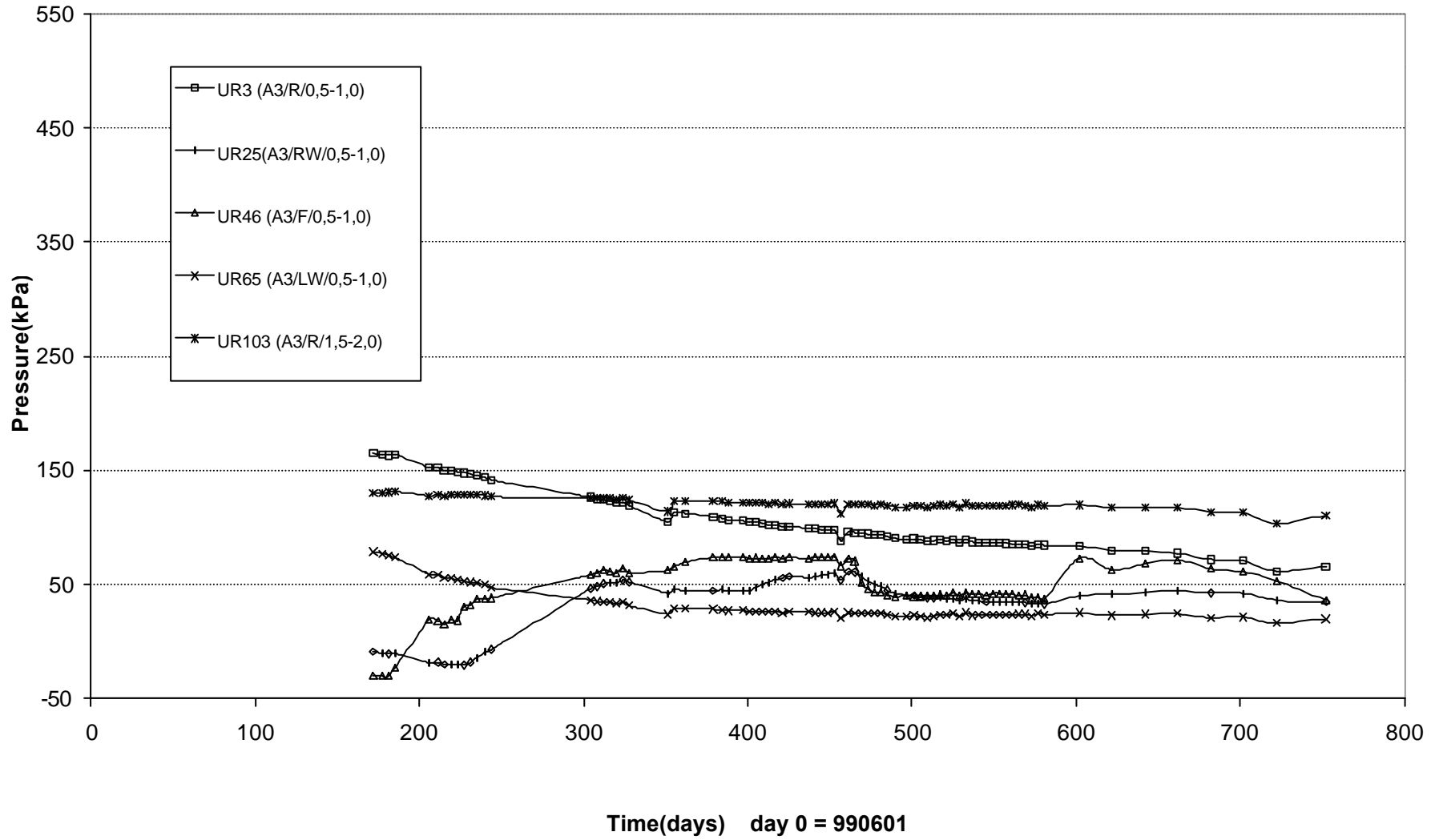

Water pressure in bore holes section A3 (990601-010701)
DRUCK

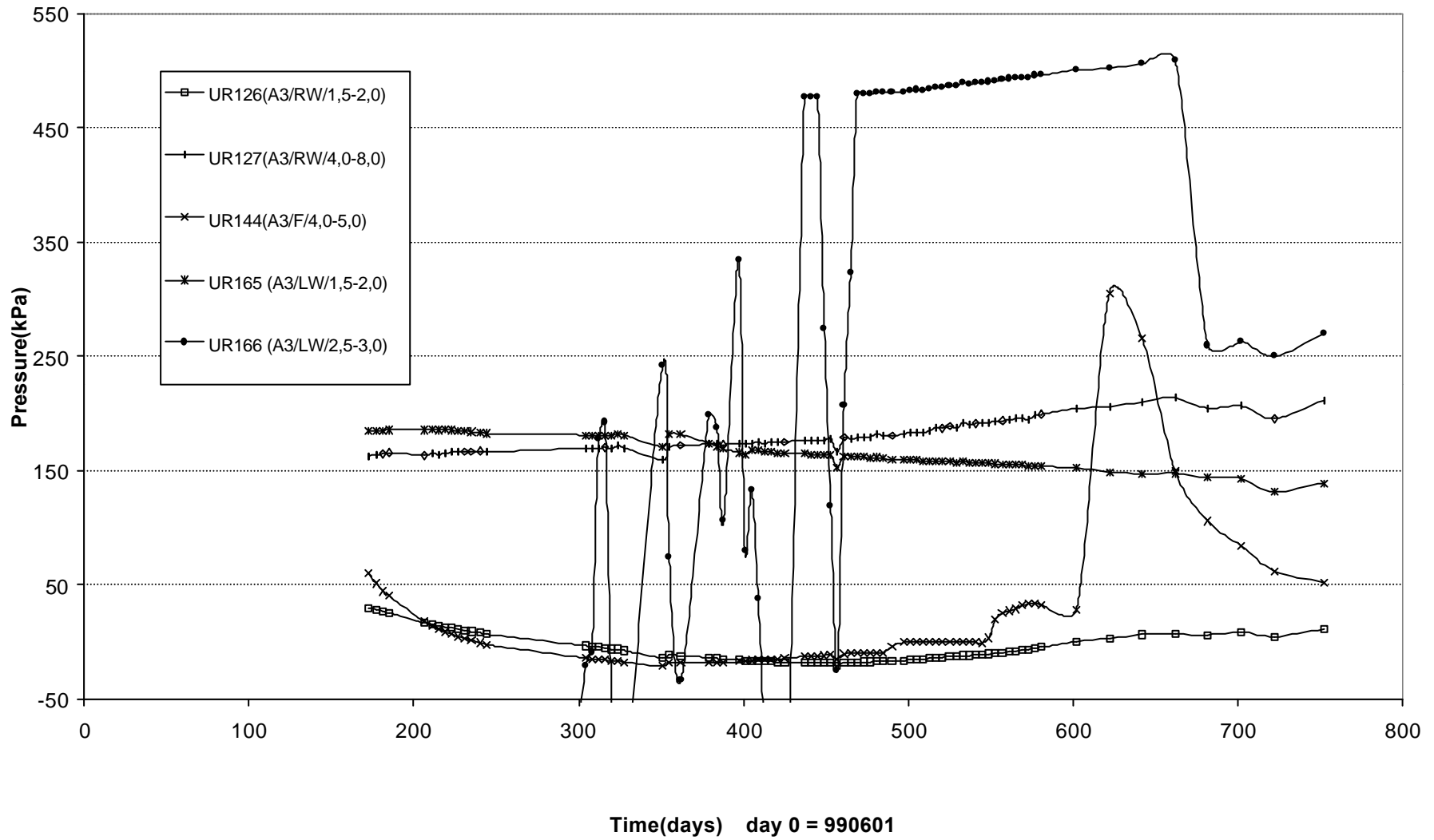

Water pressure in bore holes section A3 (990601-010701)
DRUCK

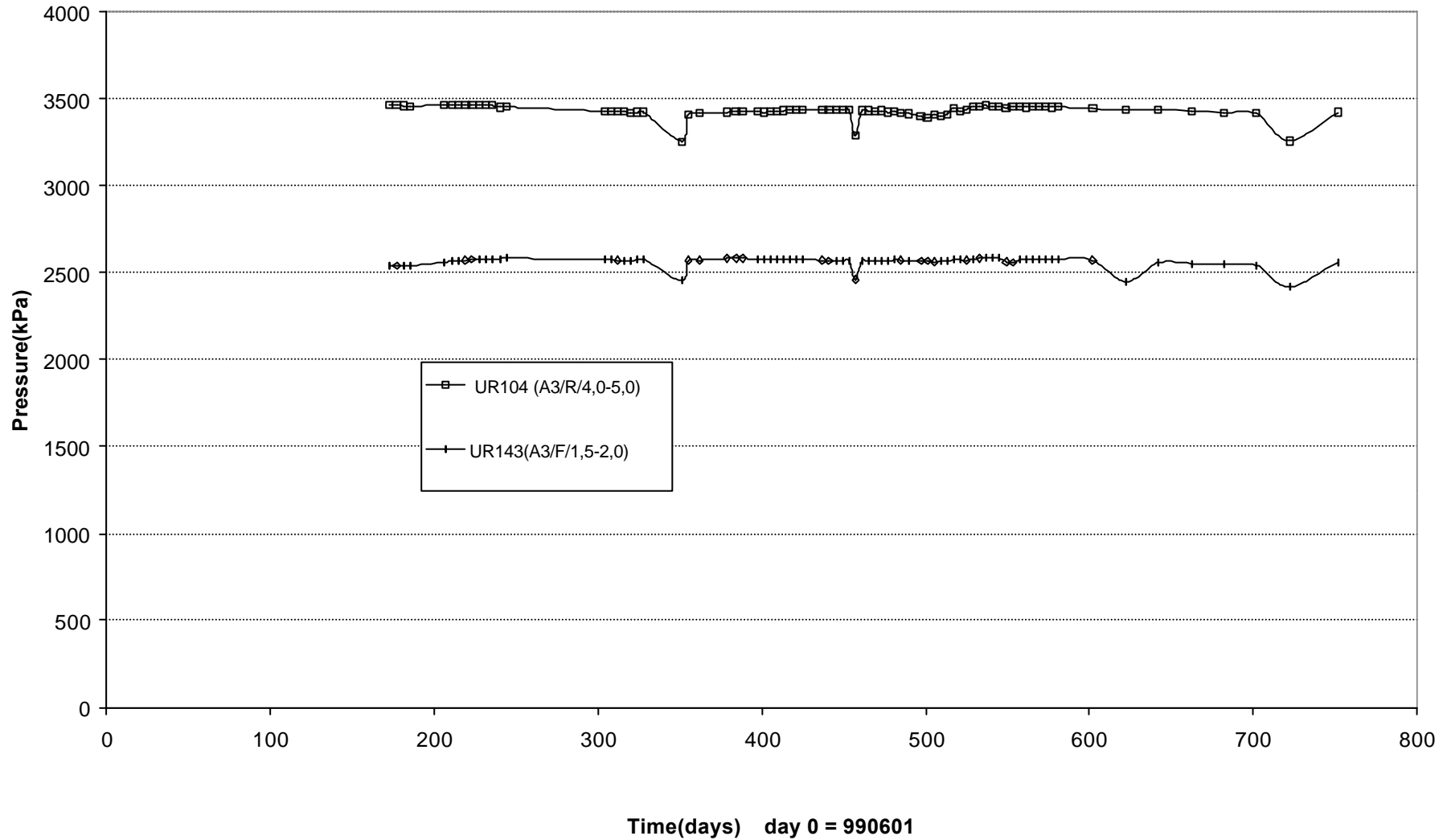

Water pressure in bore holes section A4 (990601-010701)
DRUCK

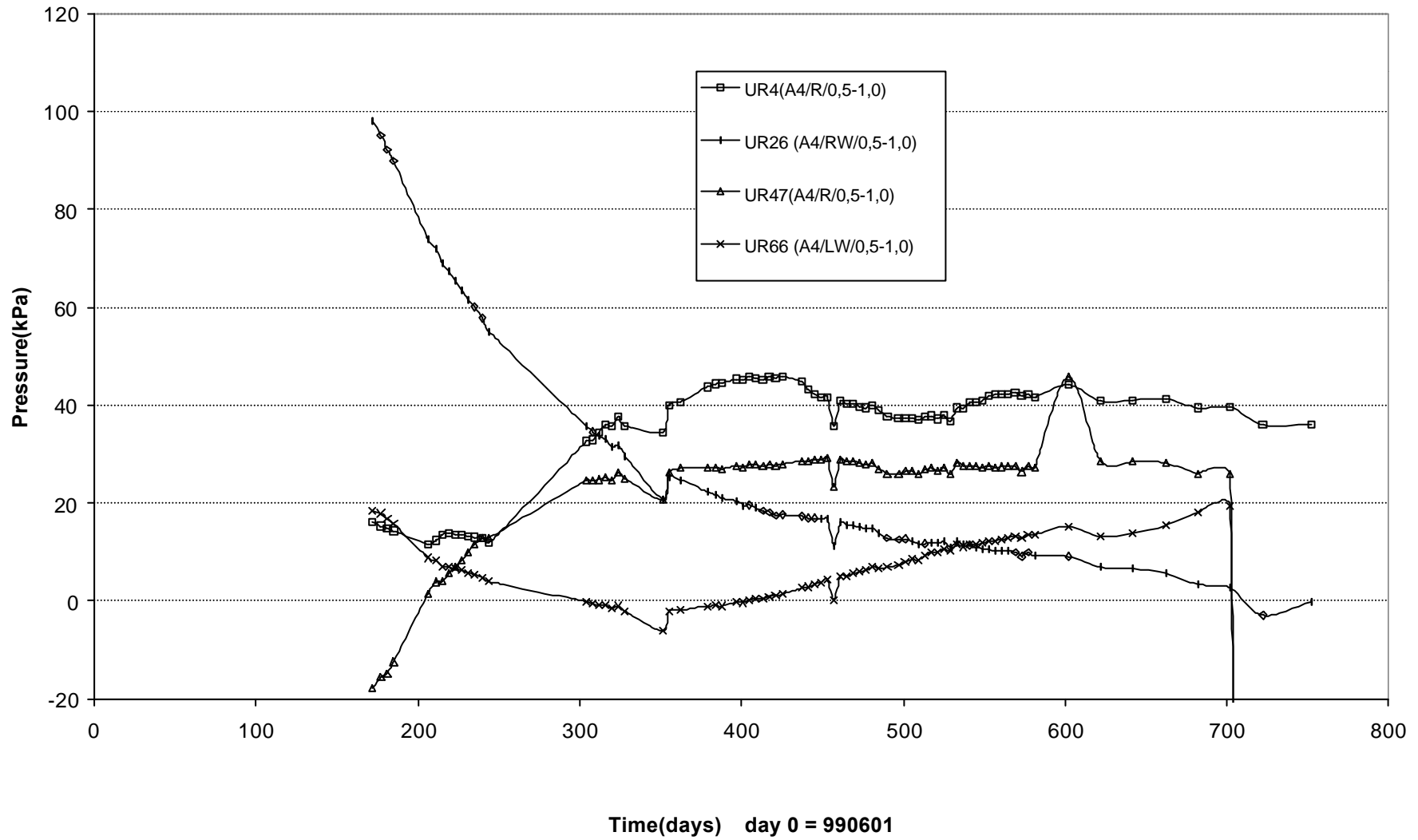

Water pressure in bore holes section A5 (990601-010701)
DRUCK

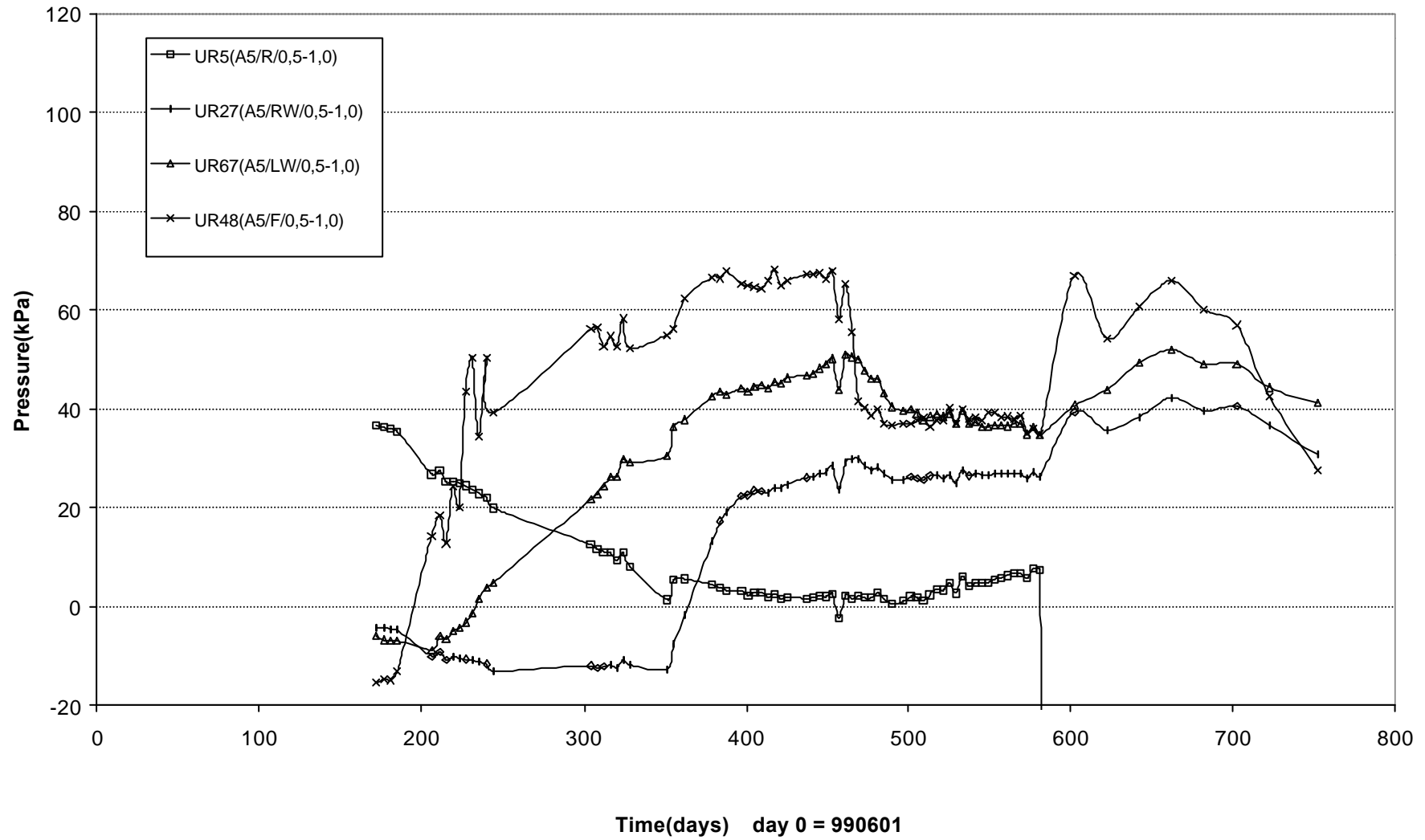

Water pressure in bore holes section B1 (990601-010701)
DRUCK

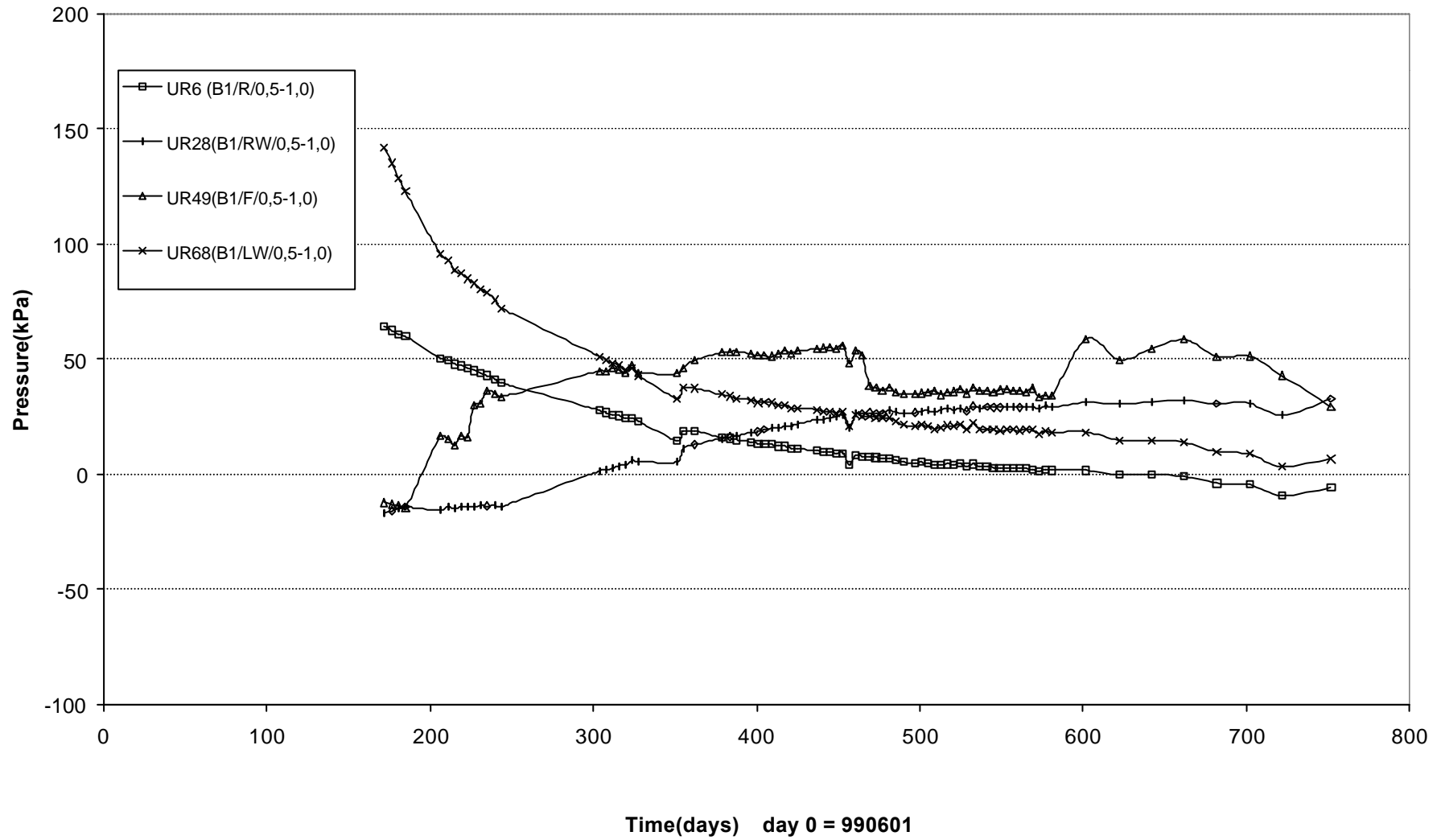

Water pressure in bore holes section B2 (990601-010701)
DRUCK

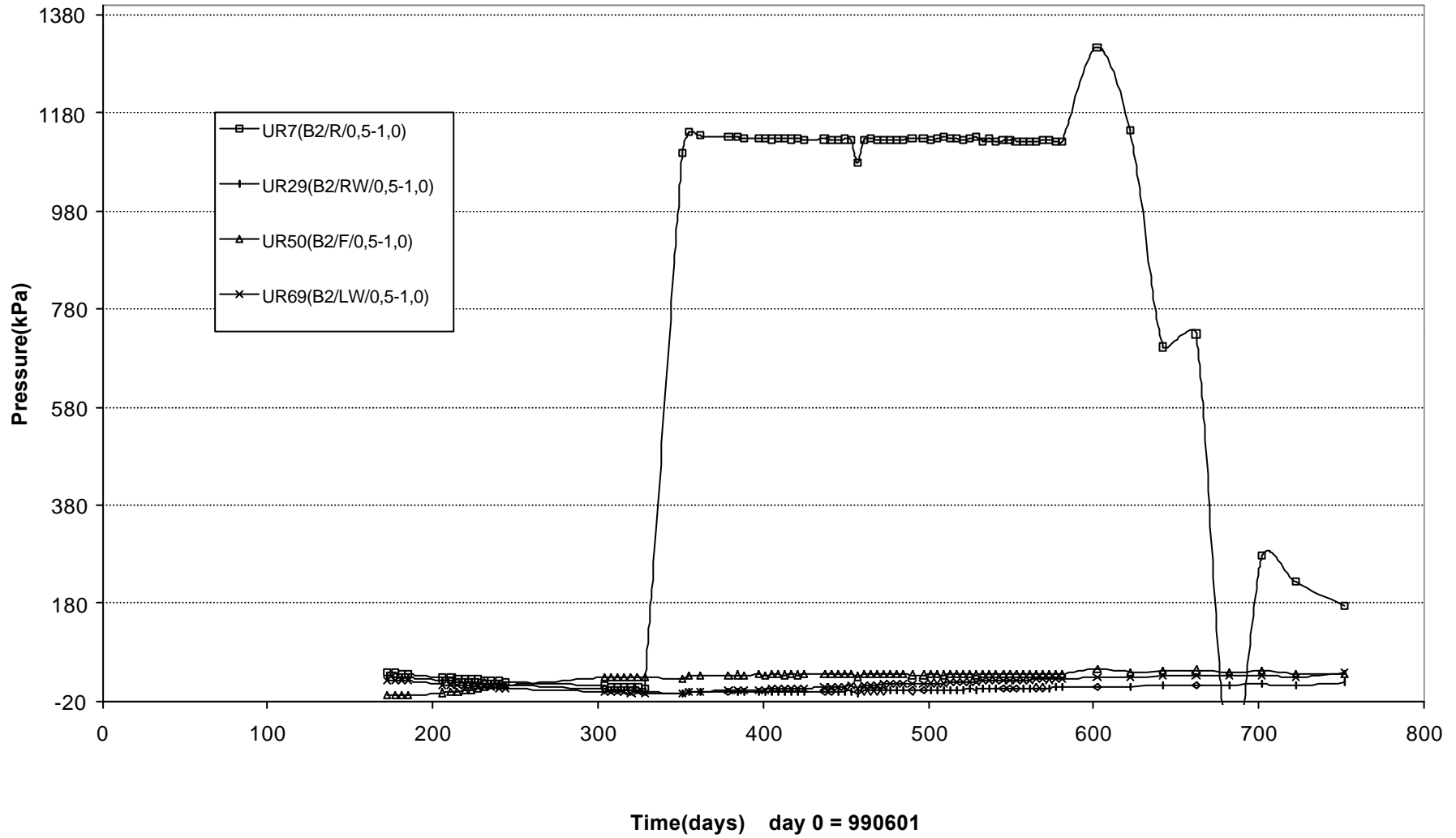

Water pressure in bore holes section B3 (990601-010701)
DRUCK

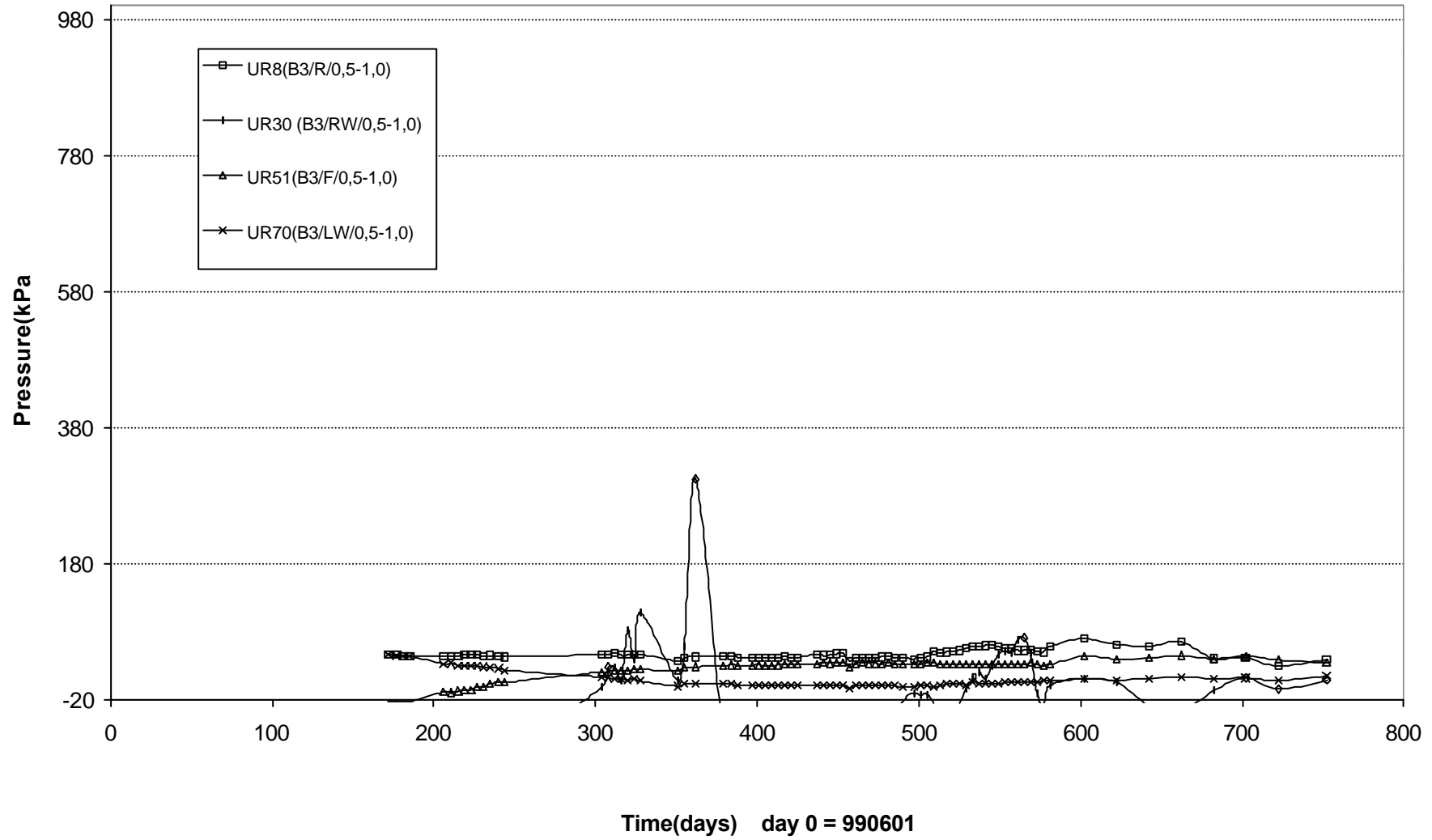

Water pressure in bore holes section B4 (990601-010701)
DRUCK

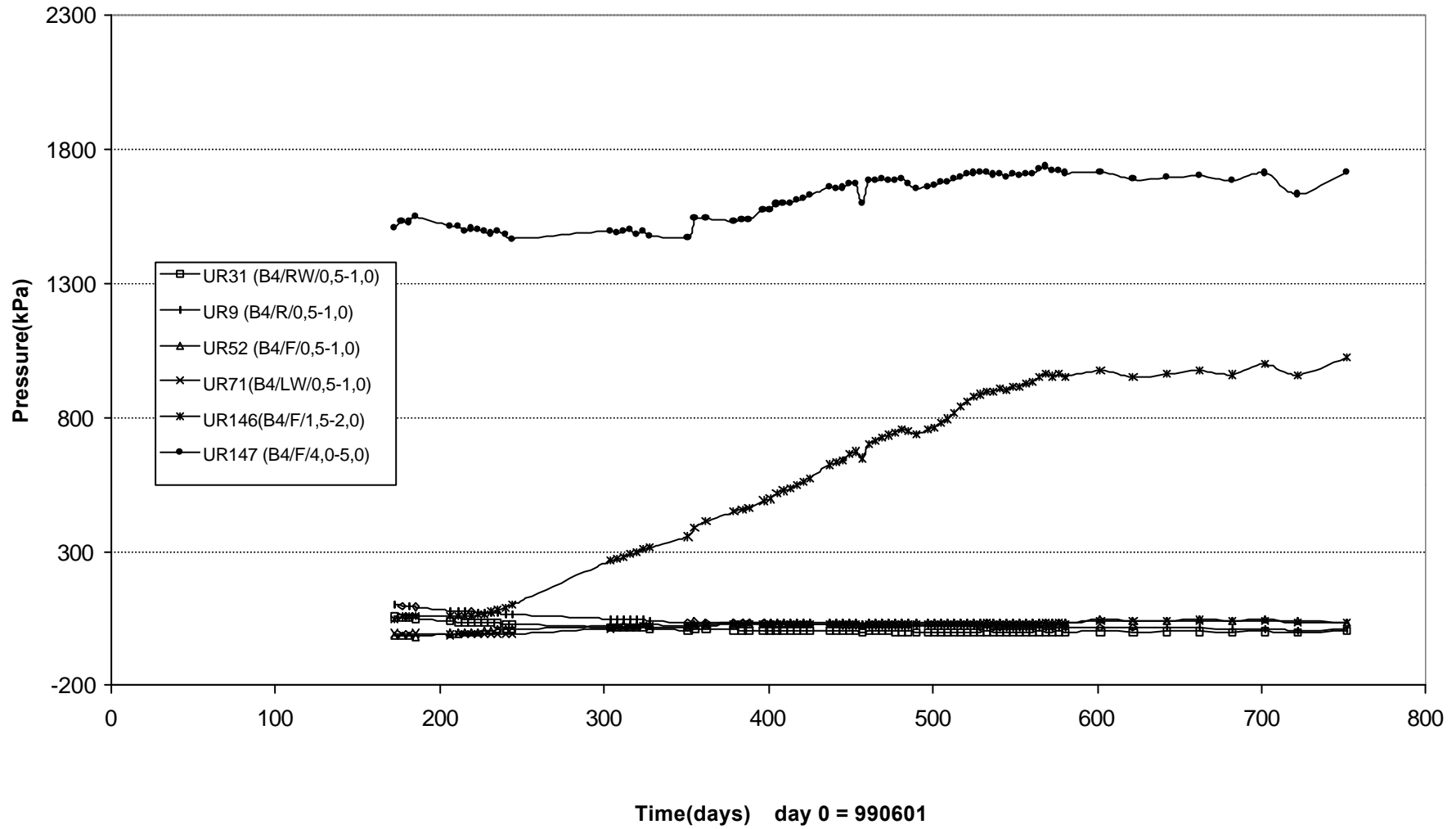

Water pressure in bore holes section B5 (990601-010701)
DRUCK

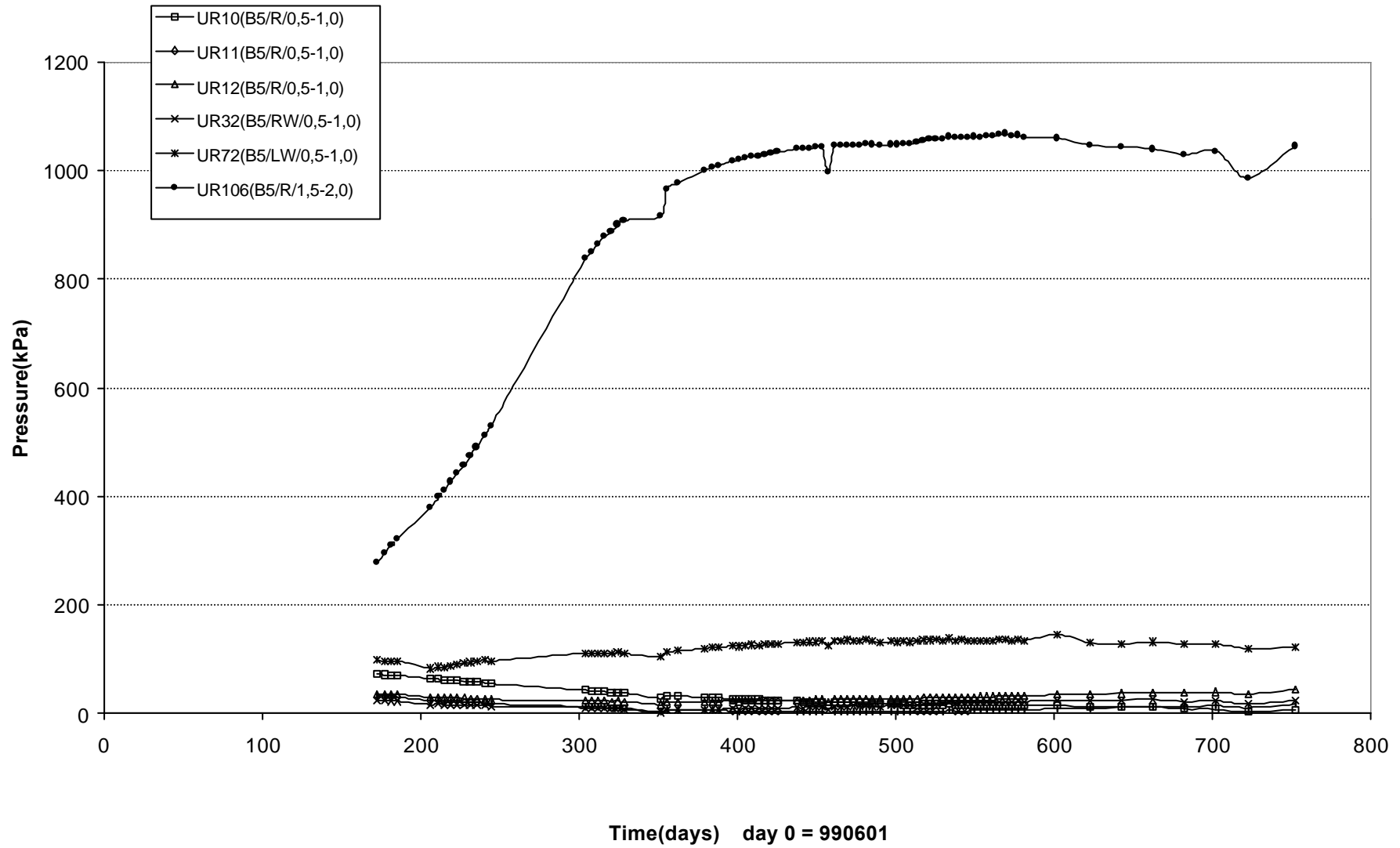

Water pressure in bore holes section B5 (990601-010701)
DRUCK

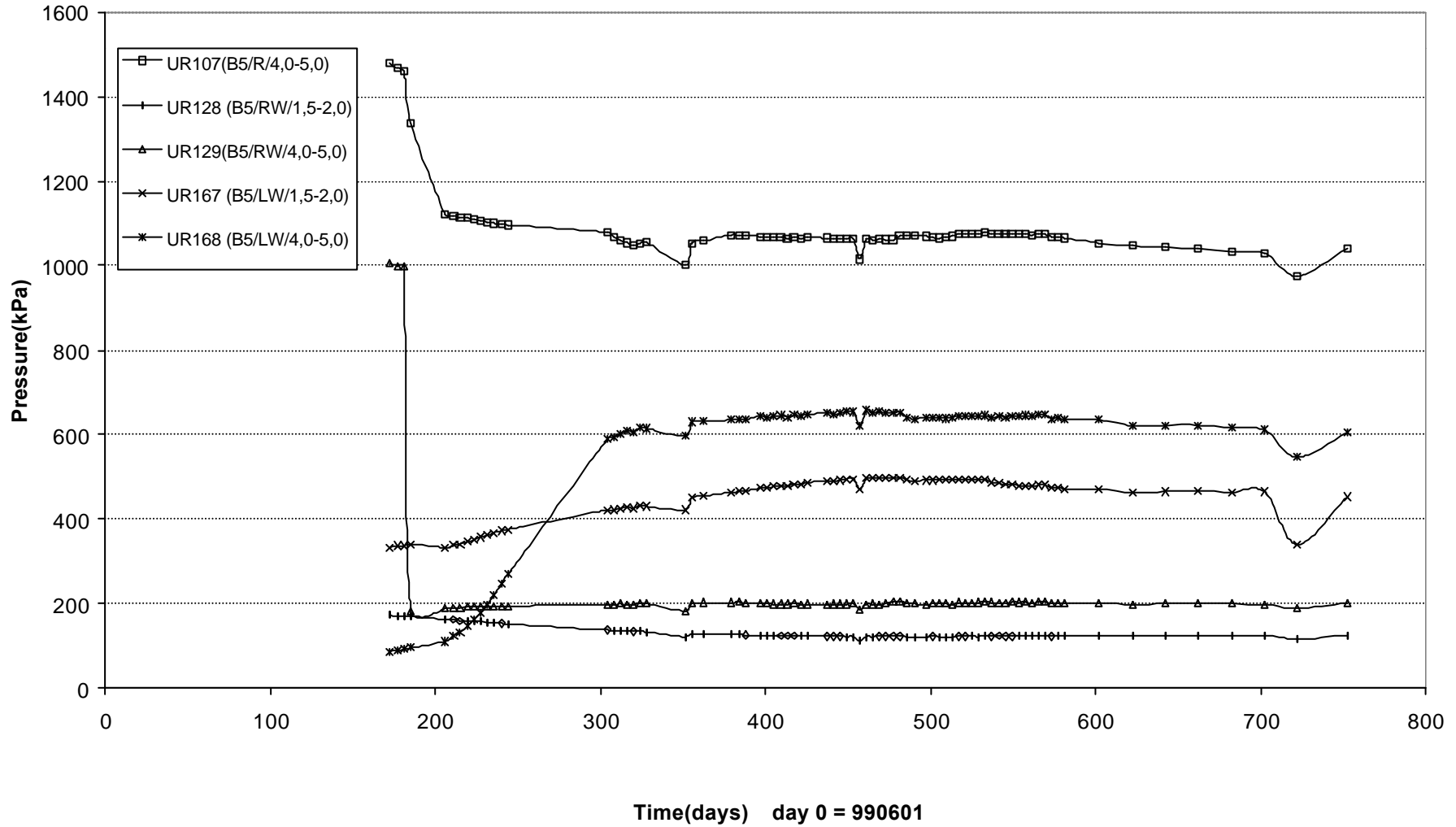

Quick guide

Layout of the test
 Numbering of backfill sections and permeable mats

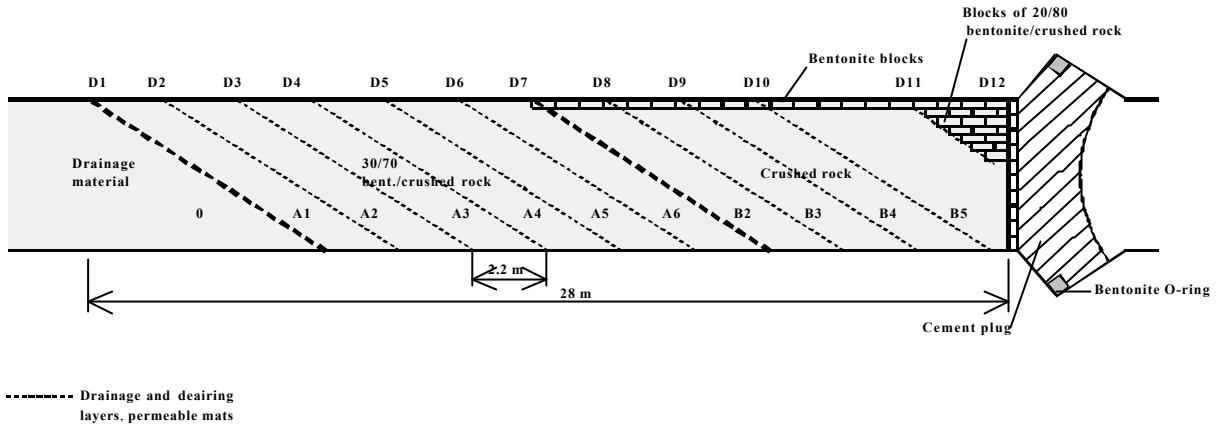

Backfill transducer

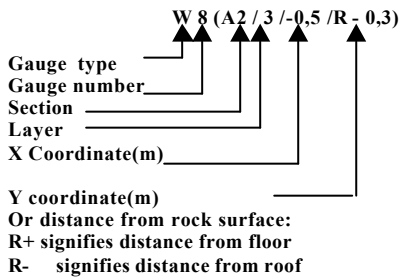

Rock transducer

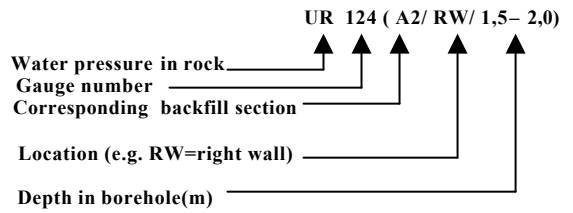

Gauge types:
 W=Water ratio
 U=Water pressure
 P=Total pressure

Co-ordinate system

