

**P-07-172**

## **Hydrological and meteorological monitoring at Oskarshamn, Januari 2007 until August 2007**

Jonas Sjögren, Robert Hillgren, Lennart Wern, Jörgen Jones  
SMHI

Alf Engdahl, Medins Biologi AB

September 2007

**Svensk Kärnbränslehantering AB**

Swedish Nuclear Fuel  
and Waste Management Co  
Box 250, SE-101 24 Stockholm  
Tel +46 8 459 84 00



## **Hydrological and meteorological monitoring at Oskarshamn, Januari 2007 until August 2007**

Jonas Sjögren, Robert Hillgren, Lennart Wern, Jörgen Jones  
SMHI

Alf Engdahl, Medins Biologi AB

September 2007

*Keywords:* Hydrological and meteorological stations, Discharge, Sea level, Conductivity, Water temperature, Air temperature, Precipitation, Barometric pressure, Global radiation, Wind speed, Wind direction, Snow depth, Ground frost, Accumulation and melting of ice, Calculated potential evapotranspiration, Evaporation.

This report concerns a study, which was conducted for SKB. The conclusions and viewpoints presented in the report are those of the authors and do not necessarily coincide with those of the client.

Data in SKB's database can be changed for different reasons. Minor changes in SKB's database will not necessarily result in a revised report. Data revisions may also be presented as supplements, available at [www.skb.se](http://www.skb.se).

A pdf version of this document can be downloaded from [www.skb.se](http://www.skb.se).

## Abstract

In the Simpevarp area nearby Oskarshamn meteorological monitoring has been going on since year 2003 and hydrological monitoring since the beginning of year 2004. Meteorological measurements are performed at two places, Åspö and Plittorp. Measured and calculated parameters at these stations are temperature, wind speed and direction, air humidity, precipitation, air pressure, global radiation and potential evapotranspiration. The Swedish Meteorological and Hydrological Institute, SMHI, has been responsible for planning and designing of the two stations used for meteorological monitoring. Furthermore, SMHI has been responsible for planning and constructing fifteen hydrological measuring stations. At these hydrological stations, water levels in lakes and in the sea are taken. Additionally water temperature and electrical conductivity are measured and discharges in watercourses calculated. Hydrological measurements are performed at fifteen different places.

This report also includes the registration and measurements of certain weather parameters that have been done within the area during the measurement period. Snow depth, depth of frost and ice cover break up was registered during wintertime.

The quality of meteorological and hydrological measurements during the period concerned, starting 2007-01-01 and ending 2007-08-31 has showed to be rather good. It has been minor interruptions in measurements according to malfunctioning equipment or maintenance work.

At the hydrological stations intended for discharge measurements in watercourses, the rating curves have been determined and discharge recalculated from station start through quality checked water level data. However, an important remark regarding data quality has to be announced. Most rating curves still have too few control measurements of discharge to be regarded as reliable, especially at higher water levels. Further measurements are therefore strongly recommended to make the rating curves reach an approved level of quality. Hydrological monitoring is made according to elevation system RT90-RHB70.

# Sammanfattning

I Simpevarpsområdet utanför Oskarshamn har meteorologiska mätningar pågått sedan år 2003 och hydrologiska mätningar sedan början av år 2004. De meteorologiska mätningarna sker på två platser, på Äspö och i Plittorp. Här har master med registrerande instrument monterats. De meteorologiska parametrar som mäts och bestäms är temperatur, vindhastighet och riktning, luftfuktighet, nederbörd, lufttryck, globalstrålning och potentiell evapotranspiration. Sveriges Meteorologiska och Hydrologiska Institut, SMHI, har varit ansvariga för utformandet av de två meteorologiska mätstationerna. SMHI har också konstruerat och byggt 15 hydrologiska mätstationer. Vid dessa mäts vattennivåer i sjöar och i havet. Ytterligare parametrar som mäts är vattentemperatur och elektrisk konduktivitet samt bestämning av vattenföringar i vattendragen.

Under perioden har det även skett en registrering av vissa väderrelaterade parametrar. Snödjup, frostdjup, tidpunkt för isläggning samt islossning har registrerats och finns inkluderade i denna rapport.

Kvaliteten hos de meteorologiska och hydrologiska mätningarna utförda under perioden 2007-01-01 till och med 2007-08-31 har varit god. Det har endast förekommit några kortare avbrott i mätningarna orsakade av fel på mätutrustningen eller på grund av underhållsarbete.

Vid de hydrologiska mätstationer där vattenföringen skall bestämmas, har avbördningskurvorna fastställts och vattenföringen beräknats från stationsstart med hjälp av kvalitetsgranskade vattenståndsdata. En viktig kommentar måste dock framhållas. Flera avbördningskurvor innehåller fortfarande för få uppmätta samband för att kunna anses som tillförlitliga, speciellt vid högre vattenstånd. Ytterligare mätningar rekommenderas därför starkt så att avbördningskurvorna kan uppnå en godtagbar kvalitetsnivå. Alla hydrologiska mätningar görs i höjdsystemet RT90-RHB70.

# Contents

<b>1</b>	<b>Introduction</b>	7
<b>2</b>	<b>Objective and scope</b>	9
<b>3</b>	<b>Equipment</b>	11
3.1	Hydrological measuring stations	11
3.1.1	Runoff stations	11
3.1.2	Water level stations	11
3.1.3	Calibration of equipment used at hydrological measuring stations	12
3.2	Meteorological measuring stations	12
3.2.1	Calibration of equipment used at meteorological measuring stations	12
3.3	Winter parameters	13
3.3.1	Depth of snow	13
3.3.2	Depth of frost in ground	13
3.3.3	Ice cover	13
<b>4</b>	<b>Execution</b>	15
4.1	General	15
4.2	Hydrological measurements	17
4.2.1	Discharge in watercourses	17
4.2.2	Water temperature and electrical conductivity, (EC)	19
4.2.3	Water level	19
4.2.4	Quality check of hydrological data	19
4.3	Meteorological measurements	20
4.3.1	Quality check of meteorological data	20
4.3.2	Data handling/post processing	20
4.4	Winter parameters	20
4.4.1	Measurement of co-ordinates	20
4.4.2	Snow depth	21
4.4.3	Frost in ground	22
4.4.4	Ice cover	22
4.4.5	Data handling and documentation	22
4.5	Analyses and interpretations	23
4.5.1	Hydrological measurements	23
4.5.2	Meteorological measurements	23
4.6	Nonconformities	24
4.6.1	Hydrological measurements	24
4.6.2	Meteorological measurements	24
4.7	Missing data and system malfunctions	25
4.7.1	Hydrological measurements	25
4.7.2	Meteorological measurements	25
<b>5</b>	<b>Results</b>	27
5.1	Hydrological monitoring	27
5.1.1	Discharge	28
5.1.2	Water level	30
5.1.3	Water temperature and electrical conductivity, (EC)	31
5.2	Meteorological monitoring	37
5.2.1	Precipitation	37
5.2.2	Barometric pressure	39
5.2.3	Air temperature	39

5.2.4	Relative humidity	39
5.2.5	Wind speed	40
5.2.6	Wind direction	40
5.2.7	Global radiation	40
5.2.8	Calculated evapotranspiration	40
5.3	Winter parameters	41
5.3.1	Snow depth	41
5.3.2	Frost in ground	41
5.3.3	Ice cover	42
	<b>References</b>	43
	<b>Appendix 1</b> Hydrological monitoring stations	45
	<b>Appendix 2</b> Rating curves for hydrological stations	47
	<b>Appendix 3</b> Measurements of snow cover	53
	<b>Appendix 4</b> Measurements of ground frost	55
	<b>Appendix 5</b> Meteorological monitoring	59

# 1 Introduction

This document reports the results of hydrological and meteorological measurements made in the area of Oskarshamn. The activities are performed within the site investigation at Oskarshamn and carried out in accordance to Activity Plan SKB AP PS 400-04-087 and SKB AP PS 400-04-088, (SKB internal controlling documents). This document also reports the data gained in “Registration of snow depth, depth of frost in the ground and time for ice cover/ice break up” which was also one of the activities performed within the site investigation at Oskarshamn. The work was carried out according to Activity Plan SKB AP PS 400-02-023 (SKB internal controlling document).

Hydrological measurements started in January 2004. Measured parameters are sea water level, water level in lakes and discharge in small creeks. Water temperature and conductivity are also measured at the runoff stations. At the moment hydrological measurements are made at fifteen different stations. Data presented in this document are quality checked and approved.

To characterise the investigation area regarding meteorological conditions SMHI has placed two stations with meteorological measuring equipment on the site. The results will be used for calculations of hydrological parameters.

The geographical locations of the meteorological and hydrological measuring stations can be seen on the map in Chapter 4.

This report presents the hydrological and meteorological monitoring and measurements of winter parameters during period 2007-01-01 until 2007-08-31.

Previous available monitoring reports and controlling documents used in the activity are presented in Table 1-1.

**Table 1-1. Controlling documents for the performance of the activity.**

<b>Activity Plan</b>	<b>Number</b>	<b>Version</b>
Yhydrologiskt monitoringsprogram	SKB AP PS 400-04-087	3.0
Meteorologiskt monitoringsprogram	SKB AP PS 400-04-088	4.0
Registrering av snödjup, tjäldjup och tider för isläggning/islossning vintern 2002/2003	SKB AP PS 400-02-023	1.0
Installation av tjäldjupsmätare	Tillägg till SKB AP PS 400-02-023	
<b>Method Descriptions</b>	<b>Number</b>	<b>Version</b>
Meteorologiska mätningar	SKB MD 364.007	1.0
Yhydrologiska mätningar	SKB MD 364.008	1.0
<b>P-reports</b>	<b>Number</b>	
Hydrological and meteorological monitoring at Oskarshamn during 2003–2004	P-05-227	
Hydrological and meteorological monitoring at Oskarshamn, November 2004 until June 2005	P-06-19	
Hydrological and meteorological monitoring at Oskarshamn, July 2005 until December 2006	P-07-38	

## 2 Objective and scope

SKB conducts site investigations for a future deep repository for spent nuclear fuel in the Laxemar area close to Oskarshamn. To characterise the investigation area regarding the meteorological conditions SMHI has installed two stations with meteorological measuring equipment at the site. The results will be used for calculations of hydrological parameters.

Hydrological measurements are performed at fifteen stations located at different sites. Since the stations were built in a period of one year, their measurements do not all start at the same time. The first station was built in January 2004 and the last in the end of January 2005. Information about the hydrological stations and periods of measurements are given in the table in Appendix 1.

This report also comprises measurements and registrations of certain weather parameters within the Oskarshamn area, during wintertime.

The objective with this report is to present quality checked results from hydrological and meteorological monitoring made during the period 2007-01-01 until 2007-08-31.



## 3 Equipment

### 3.1 Hydrological measuring stations

Common for all stations is that the battery capacity is always measured and logged. This value is however only stored in the database at SMHI.

#### 3.1.1 Runoff stations

The runoff stations PSM000341, PSM000343, PSM000345, PSM000347 and PSM000365 are constructed in concrete as V-notch weirs (triangular shaped outlet of water). At these stations, measurements are made with a Campbell CR10X data logger. A cellular phone and a GSM modem Siemens TC35, 9600 baud, establish communication. A dry cellular battery, CellTech (15V, 90 Ah) sustains power supply. Sensors and measured parameters are presented in Table 3-1.

At the runoff stations PSM000348, PSM000353, PSM000364 and PSM000368 discharge is measured according to a natural cross section in the watercourse. Equipment, sensors and measured parameters are the same as for the stations with constructed concrete dams. Water level is measured in metres above sea level, m.a.s.l. Sensors and measured parameters are presented in Table 3-2.

#### 3.1.2 Water level stations

At the water level stations PSM000359 and PSM000371 measurements are carried out with a Campbell CR510 data logger. A cellular phone and a GSM modem Siemens TC35, 9600 baud, establish communication. Power supply is sustained by a charger 1.5 A, 14 VDC connected to 230 VAC. The stations are connected to ground and equipped with a lightning conductor. Sensors and measured parameters are presented in Table 3-3.

At the water level stations PSM000369 and PSM000370 the equipment is almost the same as for PSM000359 and PSM000371 but a dry cellular battery, Celltech 14V, 90 Ah sustains power supply. Sensors and measured parameters are presented in Table 3-4.

**Table 3-1. Sensors and measured parameters at stations PSM000341, PSM000343, PSM000345, PSM000347 and PSM000365.**

Parameters	Sensors
Water level above V-notch. (cm)	DRUCK PDCR1830, mV, range 1.5 m, vented.
Conductivity and water temperature (mS/m and °C)	Campbell CS547, range 0.5–100 mS/m with interface CampbellA547.

**Table 3-2. Sensors and measured parameters at stations PSM000348, PSM000353, PSM000364 and PSM000368.**

Parameters	Sensors
Water level (m.a.s.l.)	DRUCK PDCR1830, mV, range 1.5 m, vented.
Conductivity and water temperature (mS/m and °C)	Campbell CS547, range 0.5–100 mS/m with interface CampbellA547.

**Table 3-3. Sensors and measured parameters at stations PSM000359 and PSM000371.**

Parameters	Sensors
Water level (m.a.s.l.)	DRUCK PDCR1830, mV, range 1.5 m, vented.

**Table 3-4. Sensors and measured parameters at stations PSM000369 and PSM000370.**

Parameters	Sensors
Water level (m.a.s.l.)	DRUCK PDCR1830, mV, range 1.5 m, vented.

### 3.1.3 Calibration of equipment used at hydrological measuring stations

The manufacturers calibrate the measuring equipment. DRUCK calibrates the level pressure probes and Campbell Scientific, inc. calibrates the conductivity and temperature probe. The function of every probe was thoroughly tested before deployment. These tests were performed by FDS mätteknik AB a sub-contractor to SMHI. Protocols from calibration have been delivered to SKB.

## 3.2 Meteorological measuring stations

The table below gives technical information about the equipment. Polycarbonate cupboards house data loggers (type Campbell CR10X), modem (Siemens TC35 and COM200E) and are earthed for lightning protection.

The wind is measured at 10 metres above ground level, the other parameters at 2 metres.

### 3.2.1 Calibration of equipment used at meteorological measuring stations

Calibration of the instruments using data submitted by the manufactures was done by FDS along with the installation of the instruments. At 2007-05-22 the instruments at both stations, Äspö and Plitorp, were checked and calibrated by FDS.

**Table 3-5. Measuring equipment for collecting of meteorological data at the stations.**

Parameters	Equipment
Wind speed and direction	RM Young Wind monitor
Air temperature	Pt100 sensor with radiation shield and ventilated Young 41004
Humidity	Rotronic HygroClip MP 100H
Precipitation	Geonor T200 complete with pedestal and wind shield
Pressure	PTB200
Global radiation at Äspö	Kipp&Zonen CM21 with warming and fan

### **3.3 Winter parameters**

#### **3.3.1 Depth of snow**

The snow depth has been measured according to SMHI's Handbook for observers (In Swedish: SMHI's handbok för observatörer) /2/. The measuring device has been a measuring stick graded in centimetres.

#### **3.3.2 Depth of frost in ground**

The depth of frost in the ground has been measured according to SMHI's Handbook for observers /2/. The measurements are performed with a specific measuring device. The device consists of a protective tube with a disc and a protective hood, including a measurement tube with solution. The solution consists of methylene blue and distilled water. When the water freezes the blue colour disappears and this is utilized when observing the position of frost in the ground. The measurement tube is graded in centimetres.

The ground level is marked and this together with the protective hood is what is usually seen above ground. When installing the device at Oskarshamn there were some difficulties because of the large numbers of boulders in the ground. Because of this a small part of the measuring tube is also present above ground, see Figure 3-1. This has no impact on the measurements, however.

#### **3.3.3 Ice cover**

The observation of ice freeze and break up was performed by visual inspection.



*Figure 3-1. Measuring device for registration of depth of frost in the ground at PSM006980.*

## 4 Execution

### 4.1 General

This execution chapter is intended to describe the complete course of events, from measuring, via quality check, data handling to the storage in SICADA. On the map in Figure 4-2 it is pointed out where all monitoring stations are geographically located.

Two terms that are frequently used in this context is HMS and SICADA, SKB's data system, could therefore require a definition. HMS (Hydro Monitoring System) is SKB's network for the monitoring of hydrological, hydrogeological and meteorological parameters. This is a system for collection, calculation, and data check up and presentation. SICADA is the database that contains all of SKB's quality assured data. It is from these data the modelling and analyses are done, see Figure 4-1.

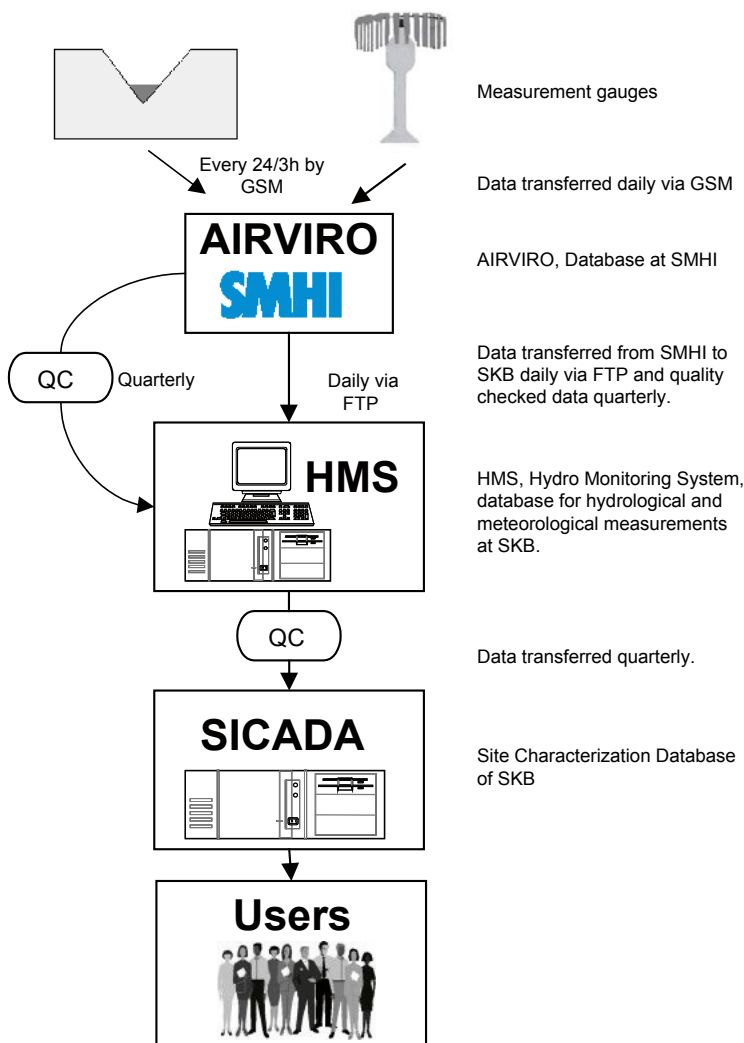

*Figure 4-1. Flowchart – meteorological and hydrological data.*

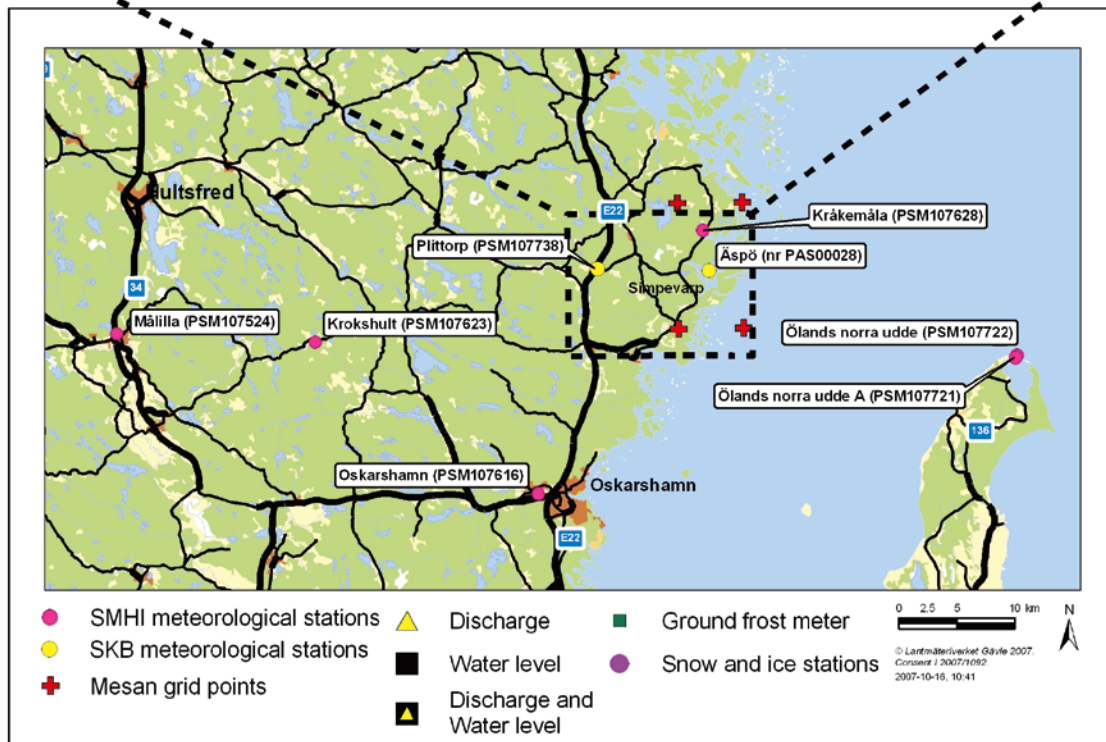
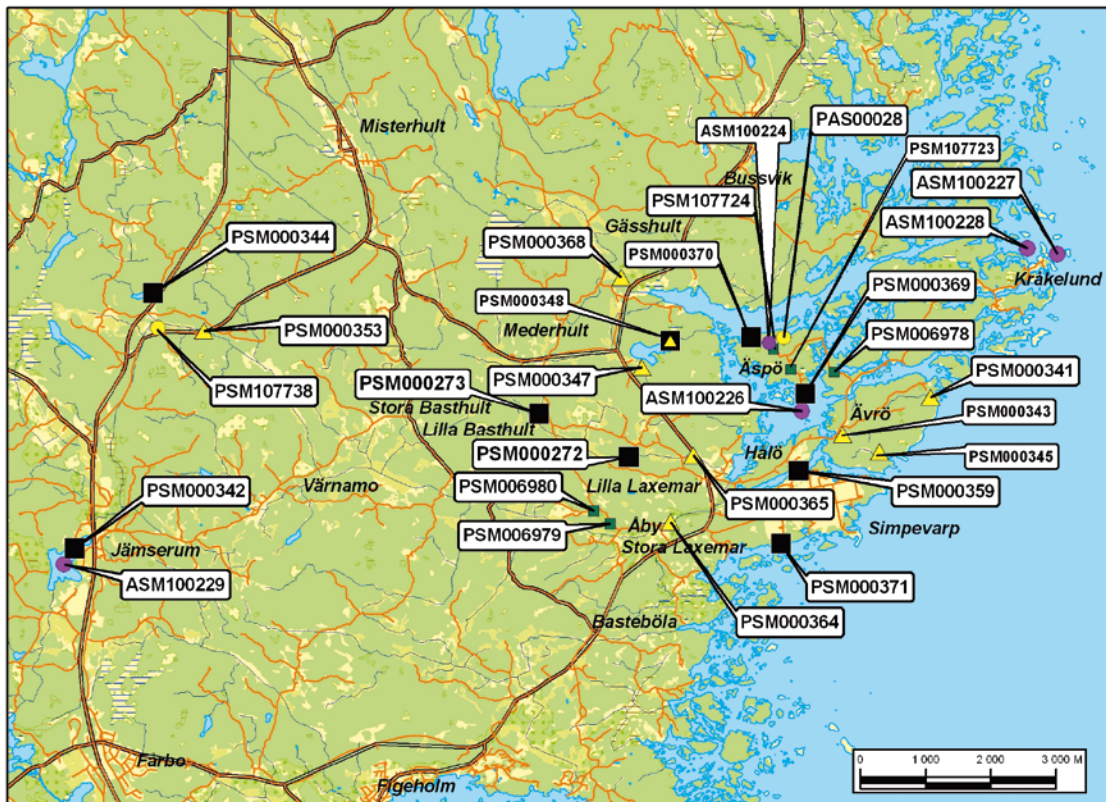

Figure 4-2. Map showing objects of all monitoring stations except Station Gladhammar (PSM107642) which is located 45 km north of Öskarshamn.

## 4.2 Hydrological measurements

All sensors, probes and other equipment shall be checked and serviced once a year or if needed as soon as possible. SMHI's sub contractor, FDS Mätteknik AB will handle malfunction of equipment. During 2006-05-21 to 2006-05-23 SMHI inspected all hydrological stations in the Simpevarp area. At each station the water level sensor was checked to log correct values and the concrete dams were levelled to check that they had not moved since they were built. At all stations the sensors for temperature and conductivity were cleansed. The water temperature was checked with a reference thermometer and water specimens were sent to the SKB laboratory for conductivity analysis.

The level pressure sensors are tested by measuring the present water level. The water level is then compared to the value in the data logger. If any discrepancy is detected the logger is adjusted.

At the runoff stations, the water head above the V-notch should be set in the data logger.

The probe used for measuring conductivity and water temperature should be tested in water with known conductivity. During the inspection a simultaneous water sample was analysed at the Äspö laboratory for comparison. The water temperature should be measured with a reference thermometer. The measured value in the data logger of conductivity and temperature are then compared with the reference values.

The runoff stations need some extra care because it is very important that the flow trough the V-notch is not blocked or influenced by ice, leaves or debris. For this reason SKB have established a scheduled standard procedure for regular inspection of the stations. The inspection and cleaning records are stored in the SICADA database.

### 4.2.1 Discharge in watercourses

Hourly measurements of discharge have been made at nine stations. Four of these stations – PSM000348, PSM000353, PSM000364 and PSM000368 – are situated at sites where a natural cross section has been used to establish the rating curves.

The other five stations – PSM000341, PSM000343, PSM000345, PSM000347 and PSM000365 – are situated at sites where concrete dams are built and where the discharge is measured with a V-notch weir. The V-notch weir is a concrete dam with a triangular, V-notch shaped, outlet. The opening angle in the V-notch varies between these stations from 45°, 60° and 120° and theoretically, the discharge (Q), could be derived from a discharge formula. The upstream level is uniquely related to the discharge over the crest where the flow passes through critical conditions. For a V-notch weir, the discharge formula becomes /1/:

$$Q = 8/15 \cdot \mu \cdot (2g)^{1/2} \cdot h^{5/2} \cdot \tan\alpha/2$$

$$Q = \text{Discharge (m}^3/\text{s)}$$

$\mu$  = Coefficient approximately constant, a value between 0.60 and 0.65

$g$  = Gravity constant (9.81 m/s<sup>2</sup>)

$h$  = Head above the V-notch (m)

$\alpha$  = Angle in V-notch

The water level (head) above the V-notch point is measured. When the water stage is at the same level as the V-notch, discharge from the weir also equals zero; i.e. the level of the V-notch point is set to zero. It should be pointed out that it is the water level that is measured at the discharge stations and not directly the discharge. The discharge has to be calculated from the discharge formula. Calculations with this equation are only reliable when the weirs are built with idealistic proportions. Due to conditions of local ground structure at the building site, idealistic dam

proportions are sometimes hard to achieve. Therefore, in most cases a rating curve has to be established before any reliable calculations of discharge can be made. Until then calculation of discharge has to be made with assumed values of parameters in the discharge formula and will be delivered as such.

At the moment discharges at station PSM000341, PSM000343 and PSM000345 are calculated from rating curves established from control measurements made by SKB and SMHI. At station PSM000347 and PSM000365 discharge is calculated with the discharge formula. In calculations at these stations the value of the coefficient  $\mu$  has been set to a reasonable level of 0.60. Presently we do not know if this is a proper value of the coefficient  $\mu$  for both these stations. The discharge values presented in this report are for that reason affected with a degree of uncertainty and later on adjustments in accordance to rating curves will be made.

The drainage areas where dams are built are very small. Therefore, the creeks or ditches will be dried up during main part of the year. The drainage area estimated by SKB and the opening angle in V-notch for each dam are presented in Table 4-1.

At the stations PSM000348, PSM000353, PSM000364 and PSM000368 discharge should be measured according to a natural cross-section in the watercourse, i.e. no dams are constructed. All water levels are measured in metres above sea level (m.a.s.l.) in elevation system RT90-RHB70. The drainage area estimated by SKB for each station is presented in Table 4-2.

At 2006-10-01 the rating curves for all discharge stations were determined, and discharge recalculated from station start through quality checked water level data. See the rating curves in Appendix 2. All discharge data was sent to SKB 2006-10-05. A rating curve describes the relationship between the measured water stage and the corresponding discharge. It usually takes some time to gain a reliable rating curve and until then measurements of water level are stored at these four stations. However, an important remark regarding data quality has to be made. Most rating curves still have too few control measurements of discharge to be regarded as reliable, especially at high water levels. Further measurements are therefore strongly recommended to make the rating curves reach an approved level of quality.

Measurements made by SKB. No change of existing rating curves.

**Table 4-1. Drainage area and V-notch angle for the dams.**

Station Id	Object	Measuring place	V-notch opening angle	Drainage area (km <sup>2</sup> )
PSM000341	Ävrö NE	Dam	45°	0.29
PSM000343	Ävrö SW	Dam	45°	0.11
PSM000345	Ävrö SE	Dam	45°	0.16
PSM000347	Frisksjön (in)	Dam	60°	0.91
PSM000365	Ekerumsån	Dam	120°	2.38

**Table 4-2. Drainage area for PSM000348, PSM000353, PSM000364 and PSM000368.**

Station Id	Object	Measuring place	Drainage area (km <sup>2</sup> )
PSM000348	Frisksjön (out)	Lake and natural cross-section	1.88
PSM000353	Laxemarån (upper)	Natural cross-section	14
PSM000364	Laxemarån (lower)	Natural cross-section	40
PSM000368	Kärrviksån	Natural cross-section	27

#### **4.2.2 Water temperature and electrical conductivity, (EC)**

At all stations monitoring discharge and also the water temperature and electrical conductivity, EC, are measured. At stations where dams are constructed, temperature and EC are measured in the small basin upstream the concrete dam. At stations where natural cross sections are used the sensor is placed as deep as possible in the creek or the lake. One value of temperature and electrical conductivity is collected every hour.

#### **4.2.3 Water level**

The logged water level is an arithmetic mean value calculated from measurements made every fifth second during one hour. Hourly mean values are stored.

##### ***Sea water level***

Sea water level is measured at three places in the surroundings of Äspö. The stations are PSM000369, PSM000370 and PSM000371. At these stations, measurements have been performed since January 2004. Measurements are taken in elevation system RT90-RHB70 and they are expressed as metres above sea level (m.a.s.l.).

##### ***Water level measured in lakes and reservoirs***

Water level is also measured at station PSM000342 and PSM000344. At PSM000342 water level is measured in lake Jämsen and at station PSM000344 in lake Plittorpsgöl. All measurements are in elevation system RT90-RHB70. At one station, PSM000359, the water level in the reservoir at Sörå is measured. This is an artificial reservoir created as a backup for the freshwater supply to the nuclear power station. Measurements are in metres above sea level, (m.a.s.l.), in elevation system RT90-RHB70.

#### **4.2.4 Quality check of hydrological data**

Before any data are finally stored in SKB's database SICADA they have to be approved. Each week SMHI performs a primary check for deviating values and every third month a senior hydrologist will check and approve data before the delivery for final storage in SKB's database, SICADA. Delivery of checked and approved data to SKB is carried out quarterly.

##### ***Quality check of discharge stations***

Weekly data is checked to limit possible disturbances and interruptions. Measurements of runoff are compared between neighbouring stations. Runoff from stations in nearby areas should mostly show the same pattern. Corrections of data are made if any disturbances or irregularities appear.

Water temperature and conductivity measurements are also compared between nearby stations. Even here, the same pattern is mostly expected. Disturbances or irregularities are corrected. Measurements of conductivity and water temperature are not approved when the water level is equal to or below the V-notch point in the dams. No water is then running in the creek and temperature and conductivity values are therefore not representative.

##### ***Quality check of water level stations***

Data checks are made weekly to limit possible disturbances and interruptions.

Measurements from seawater level stations compare to each other because the same pattern is mostly expected. Corrections and adjustments of any disturbances or irregularities are made.



Water level at PSM000359, being a reservoir, does not follow the same pattern as the sea level stations. For this reason, measurements of water level at this station are judged separately. Disturbances or irregularities are corrected.

Water levels taken in lakes are compared to each other because the same behaviour is expected.

### **4.3 Meteorological measurements**

Data are collected every half-hour. The different parameters are valid for the following time period:

- Precipitation: Accumulated sum of precipitation every 30 min. The 30-min precipitation value is the difference between two adjacent accumulated precipitation sums.
- Temperature: Arithmetic mean of 1-second values for 30 minutes.
- Air pressure: Arithmetic mean of 1-second values for 30 minutes.
- Relative humidity: Arithmetic mean of 1-second values for 30 minutes.
- Wind speed and wind direction: The latest 10-minutes mean value for the actual half-hour, hence for the 10.00 data the measurement is from 09.51 to 10.00.
- Global radiation: Arithmetic mean of 1-second values for 30 minutes.

#### **4.3.1 Quality check of meteorological data**

Before any data finally will be stored in SKB's database SICADA they have to be controlled and approved by SMHI. Every week a primary check for missing and incorrect values will be performed by SMHI and every third month the check will be performed by a meteorologist at SMHI that will approve data, calculate potential evapotranspiration and estimate the true precipitation before delivery for final storage in SKB's database, SICADA.

#### **4.3.2 Data handling/post processing**

The data logger at the station has an internal memory to secure the data in case of communication disturbances. The system is called upon every three hours through SMHI's air quality system AIRVIRO, where the data is stored and the quality assurance and check is done. After this check has been performed, data is delivered to the HMS database.

SMHI has constructed a homepage according to SKB's wishes, where the results of the measurements can be shown as graphs and from which data can be extracted. The address is: <http://www.airviro.smhi.se/oskarshamn/>

### **4.4 Winter parameters**

#### **4.4.1 Measurement of co-ordinates**

Coordinates for each station, Figure 4-2, were measured according to SKB's instruction SKB MD 110.001 /3/. The co-ordinates were then noted in a specific protocol. Each object received a specific ID-code, see Table 4-3. For measurement of snow depth and observations of ice conditions, the objects were registered as surfaces, while the objects for frost in the ground and ice conditions were registered as points.

**Table 4-3. Id-code numbers for the objects in this activity.**

Measurement/observation	Id-code	Name
Snow depth	ASM100224	Grillplatsen
	PSM007724	Grillplatsen
Frost in ground	PSM006978	Löv1
	PSM006979	Grindstugan
	PSM006980	Åker
	ASM100226	Äspö brygga
Ice cover	ASM100227	Kråkelund yttre
	ASM100228	Kråkelund inre
	ASM100229	Jämsen

#### 4.4.2 Snow depth

Snow depth is in this case defined as the depth of snow from snow surface to ground. The characteristics of the site for execution of the measurement are of vital importance. The site should have a fairly smooth ground surface and the snow should not fall in drifts or be blown away. The sampling station has been a forest glade (see map in Figure 4-2). The chosen areas were marked with poles of such a length that they would be seen even at maximum snow depth, Figure 4-3.

The measurement was executed once a week starting from the autumn's first snowfall until the snow surface was completely gone during springtime. The measurement was performed once a week, even if no snow had been falling, since packing, melting or evaporation should be considered as well.

The measurement was performed with a graded measuring stick, which was vertically squeezed through the snow layer until the ground was hit. The snow depth was read in centimetres. The measurement was performed at six places in the measuring area, Figure 4-4. The average snow depth was then calculated.

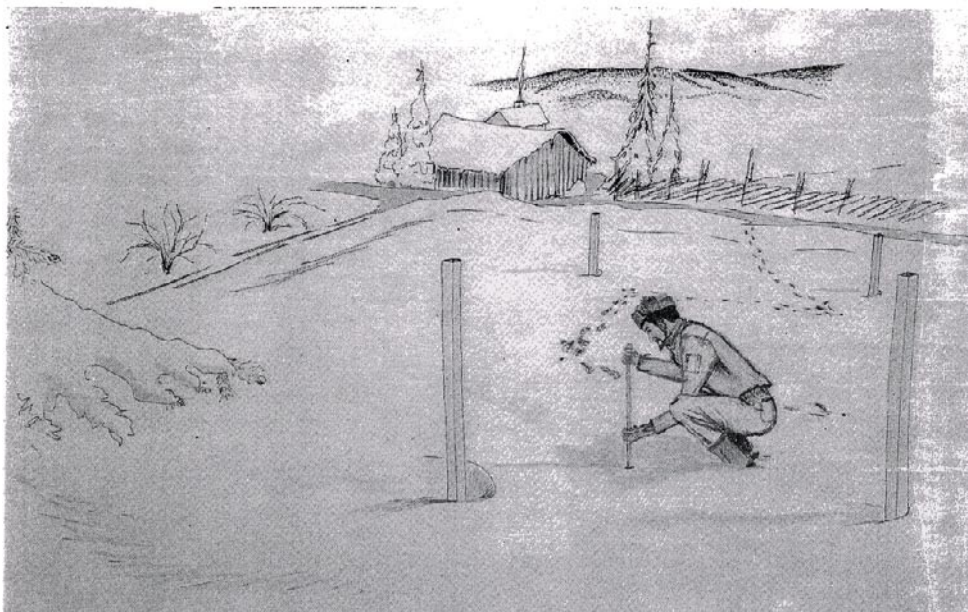

**Figure 4-3.** Measurement of snow depth, from SMHI's Handbook for observers /2/.

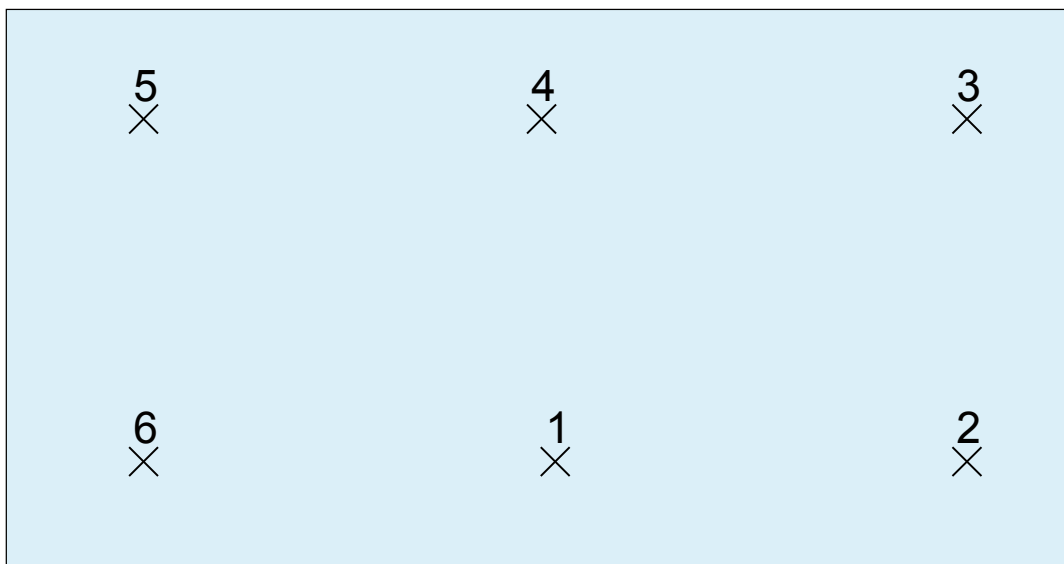

*Figure 4-4. Placement of the graded measuring stick in the area for measuring of snow depth. The distance between the measuring points is 1.5–2 m.*

#### **4.4.3 Frost in ground**

For measurement of frost in the ground, equipment according to Section 3.3.2 was used. The measurements were carried out at four places representative for the local conditions, taking in consideration soil characteristics and topography.

The measuring device is read by observing the uncoloured part of the tube solution, i.e. the frozen part, which shows the border between ice and water. The distance from ground surface to the frost in the ground, was received by reducing the read values with the distance from the scale zero to the ground surface. The measurements were performed once a week in connection to registration of snow depth.

#### **4.4.4 Ice cover**

The time for ice freeze up/ice break was noted for sea bays (ASM100226-ASM100228) and for lakes in the area (ASM100229).

For the sea, ice conditions were registered every morning during working week and for the lake once a week. While ice freeze up was observed on the lake, the other lakes in the area were also observed, to check the representatively of Lake Jämsen (ASM100229).

The time for the first ice freeze up, which is important to register in the observations, is defined as the first time of the season when a lasting ice cover occurs. The time for the last ice break up is defined as the time when the ice cover from the winter season finally breaks up. Short periods in early autumn, with thin ice covers were ignored, as well as partial ice during springtime.

#### **4.4.5 Data handling and documentation**

Field personnel from the SKB executed all measurements and observations of snow depth, frost in ground and ice cover in the activity. The primary data was registered in SICADA.

## 4.5 Analyses and interpretations

### 4.5.1 Hydrological measurements

Runoff per area unit has been calculated for all discharge stations during the period 2007-01-01 to 2007-08-31, see Figure 4-5. Runoff in this part of Sweden based on measurements during the years 1961–1990 is about 51/(s·km<sup>2</sup>). However, this long-term mean value is not comparable to the above period since the station period is too short.

### 4.5.2 Meteorological measurements

SMHI has continuously checked the collected data, i.e. checked that the data is within the limits of reason for each parameter. The data have also been compared with data from SMHI's analysing system MESAN. MESAN is an automatic system for mesoscale analysis of meteorological parameters, built on manual as well as automatic observations and including satellite- and radar information.

The values are interpolated from the nearest grid points in MESAN. The resolution of MESAN is 11×11 km and an analysis is made every hour. Corrected data has been stored in a special database. In Table 4-4 you can see the coordinates of the nearest grid points.

**Table 4-4. Mesan grid points.**

Latitude	Longitude
57.356	16.647
57.448	16.719
57.579	16.620
57.487	16.548

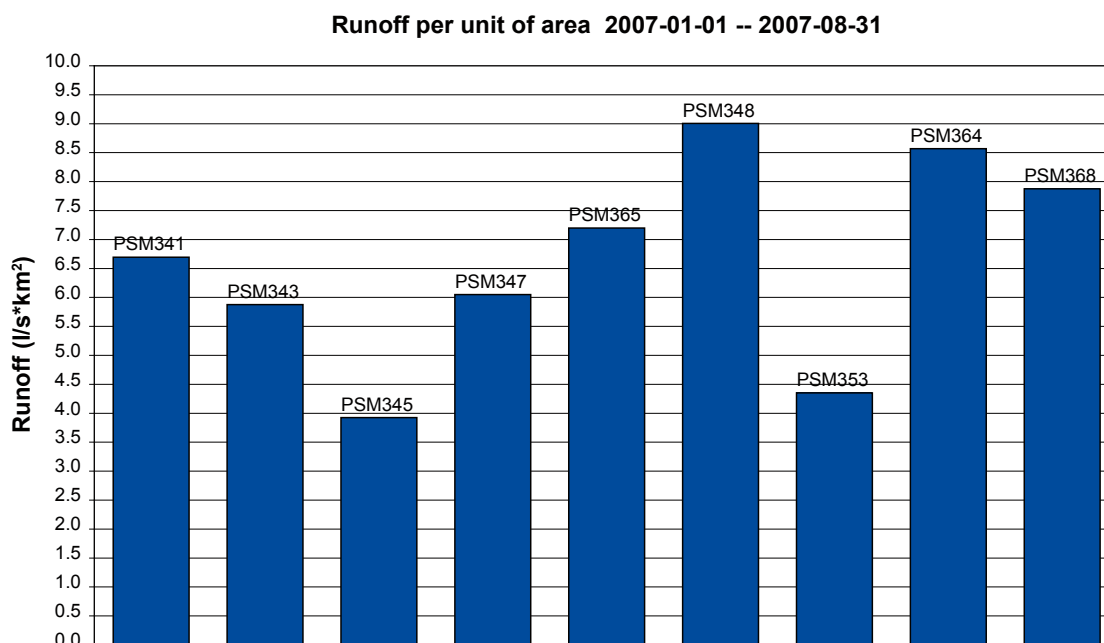

*Figure 4-5. Runoff expressed as l/s·km<sup>2</sup> during the period 2007-01-01 to 2007-08-31.*

## 4.6 Nonconformities

### 4.6.1 Hydrological measurements

During SMHI's inspection and levelling of the hydrological stations during 2007-05-21 to 2007-05-23, some discrepancies regarding water levels were detected. The criteria for correction of the discrepancies has been set to the following:

- Discharge stations with V-notch:  $> \pm 10$  mm and the same sign (positive or negative) as last inspection.
- Discharge stations without V-notch:  $> \pm 20$  mm and the same sign (positive or negative) as last inspection.

These criteria resulted in correction of PSM000365, PSM000348, PSM000353, PSM000364 and PSM000368 in their respective logger 2007-07-19. For all stations except PSM000368 the discharge was not recalculated since it is not known from what date the error started. For station PSM000368 the discharge was recalculated from the date the adjustment of the instrument took place (2007-05-15). As some data prior to this moment may have been affected, water level data in the period 2007-03-17 to 2007-05-15 was deleted. Corrections at stations PSM000342 and PSM000344 have not been carried out due to uncertainty in the measurements.

At station PSM000341 (Vadvikebäcken) the logged water level appeared to be 0.7 cm too high.

At station PSM000345 (Skölkebäcken) the logged water level appeared to be 0.9 cm too low.

At station PSM000347 (Frisksjön in) the logged water level appeared to be 1.0 cm too low.

At station PSM000365 (Ekerumsån) the logged water level appeared to be 1.5 cm too high.

At station PSM000348 (Frisksjön ut) the logged water level appeared to be 1.6 cm too high.

At station PSM000353 (Laxemarån övre) the logged water level appeared to be 1.5 cm too high.

At station PSM000364 (Laxemarån nedre) the logged water level appeared to be 1.7 cm too low.

At station PSM000368 (Kärrviksån) the logged water level appeared to be 32.4 cm too low. This discrepancy occurred when moving the instrument with purpose to prevent observations being affected by clay or soil in the river. A deviation report has been sent.

At station PSM000369 (Äspö södra) the logged water level appeared to be 0.6 cm too high.

At station PSM000370 (Äspö norra) the logged water level appeared to be 2.4 cm too high.

At station PSM000359 (Lake Söråmagasinet) the logged water level appeared to be 0.7 cm too high.

At station PSM000342 (Jämsen) the logged water level appeared to be 2.2 cm too high.

At station PSM000344 (Plittorpsgöl) the logged water level appeared to be 2.2 cm too high.

### 4.6.2 Meteorological measurements

No deviation reports have been sent.

There has been no major deviation.

## **4.7 Missing data and system malfunctions**

### **4.7.1 Hydrological measurements**

At 2007-04-06 the logger at PSM000369 Äspö S stopped deliver water level data as well as battery level data. The problem was reported to FDS Mätteknik who believed is was kind of a communication failure since the battery was in good shape right before it occurred. The station was thoroughly checked in week 21 and all missing data were found and put into place.

At 2007-07-25 the battery level at station PSM000371 dropped due to a break in mains voltage. This was taken care of 2007-08-14. The same thing happened 2007-08-25 to 2007-08-26. However, no data was lost.

### **4.7.2 Meteorological measurements**

There have been 2 problems with the wind anemometers:

- Äspö wind anemometer was frozen 2007-01-21 23:30 until 2007-01-26 08:00.  
A technician from SKB climbed up and fixed the problem.
- Plittorp wind anemometer was frozen 2007-02-05 20:30 until 2007-02-07 11:00.

During these occasions, the potential evapotranspiration can not be calculated.

There are also some minor problems with the pressure at Plittorp. At 2007-03-16 14:00 the pressure was suddenly about 1 hpa to low. This error is too small to take away. At 2007-06-13 03:30 and at 2007-08-03 06:30 the pressure was suddenly about 4.5 respectively 8 hPa to low at the same station. These values were deleted.

Except these problems, the meteorological measurements have turned out to work well during the period of this report.

## 5 Results

### 5.1 Hydrological monitoring

Totally fifteen hydrological stations are built. Hydrological measurements at these stations have worked rather well during the period 2007-01-01 to 2007-08-31. It has only been minor interruptions in measurements caused by malfunctioning equipment. The quality of measurements regarding water levels in lakes, reservoirs and sea is very good and only minor adjustments of data have been necessary.

At the discharge stations where constructed dams are built, quality of measured data almost exclusively depends on the maintenance of the basin upstream the dam. Therefore it is very important that the dams are cleaned from debris blocking the flow through the V-notches. Most of the corrections made to measurements according discharge have been made because the V-notches periodically have been obstructed by ice, leaves or debris floating in the water. At discharge stations, using a natural cross section most corrections of measured water levels are made during the time of ice break up. Ice in the watercourse is then building ice jams and measured water levels are not representative for discharge calculations. The water level in such situations have been interpolated between the level before and after the occasion of the peak caused by the ice jam.

At 2006-10-01 the rating curves for all discharge stations were determined, and discharge recalculated from station start through quality checked water level data. See the rating curves in Appendix 2. All discharge data was sent to SKB 2006-10-05. During 2007 additional discharge measurements have been made to increase the reliability and quality of the rating curves. These measurements have not motivated any change of the existing curves. However, an important remark regarding data quality has to be made. Most rating curves still have too few control measurements of discharge to be regarded as reliable, especially at higher water levels. Further measurements are therefore strongly recommended to make the rating curves reach an approved level of quality.

Measurements of water temperature at the discharge stations seem so far to work well. Even here, only a few measured values have been corrected when making quality check of data.

Measurements of electrical conductivity, EC, have also worked quite well. However, more corrections according to obviously strange values have been necessary to make than for other measured parameters. It has turned out that it seems to be very important that the temperature and conductivity sensors are kept clean. During the vegetation period, the sensors seem to be covered with organic material and for that reason, it is necessary to clean the sensors at some occasions during this period. The smallest watercourses dry up a great part of the season and the sensors must be cleaned during such periods. Otherwise, there is a risk of erroneous values when the water starts to flow again.

### 5.1.1 Discharge

#### **PSM000341, PSM000343, PSM000345, PSM000347 and PSM000365**

The quality checked values of discharge from the five stations with constructed dams are presented in Figure 5-1 and 5-2. Adjustment of measurements has been made to stations PSM000343 and PSM000345, at some occasions because the V-notches have been blocked.

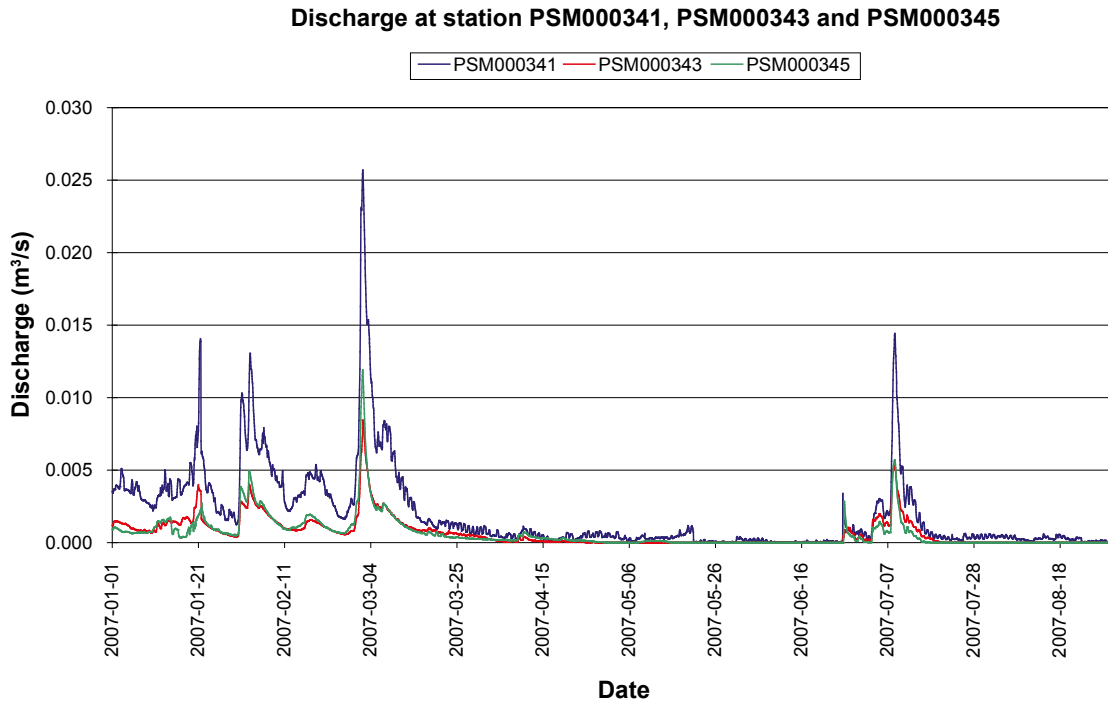

Figure 5-1. Quality assured discharge, m<sup>3</sup>/s, at stations PSM000341, PSM000343 and PSM000345.

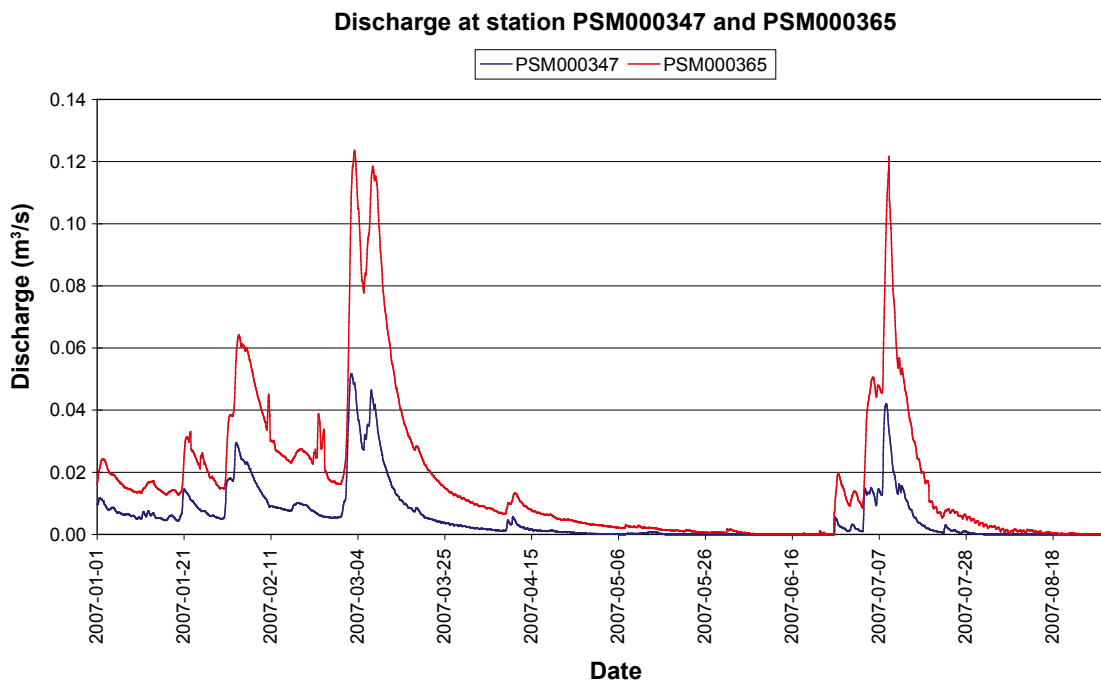

Figure 5-2. Quality assured discharge, m<sup>3</sup>/s, for station PSM000347 and PSM000365.



**PSM000348, PSM000353, PSM000364 and PSM000368**

At four stations discharge is measured by using a natural cross-section in the watercourse, i.e. no dams are constructed. At station PSM000348 the discharge represents the outflow from lake Frisksjön. At all other places discharge is measured in the creek. The quality checked discharge from measurements of water level made during the period could be seen in Figures 5-3 to 5-5. Adjustment of measurements has been made to PSM000368 where the sensor was buried into water bed soil.

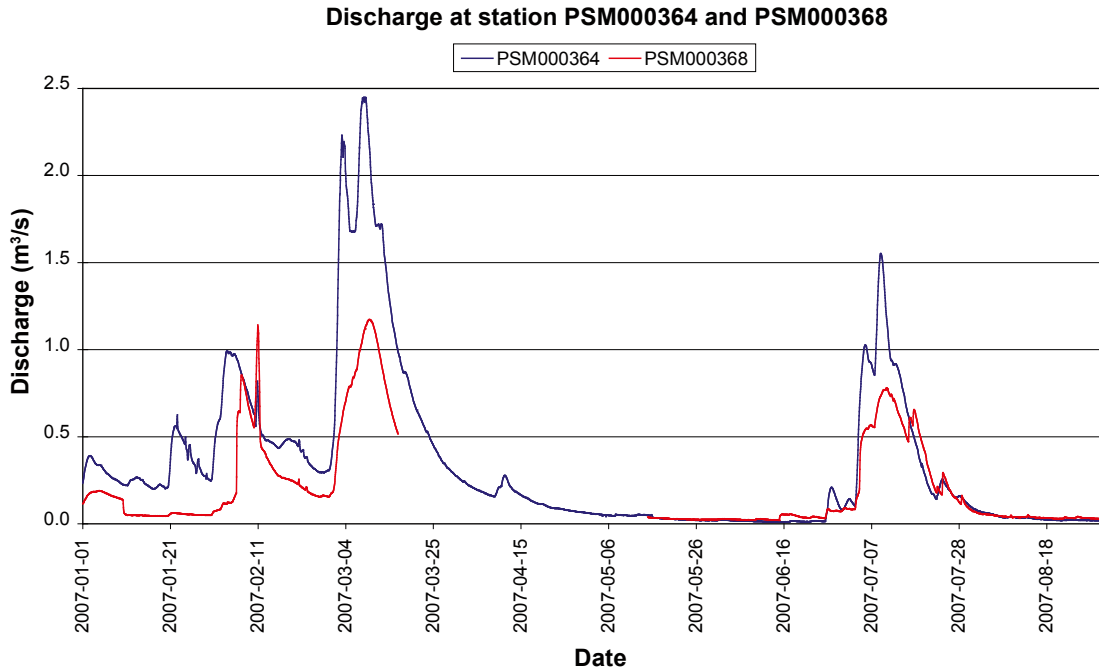

Figure 5-3. Quality assured discharge, m<sup>3</sup>/s, for stations PSM000364 and PSM000368.

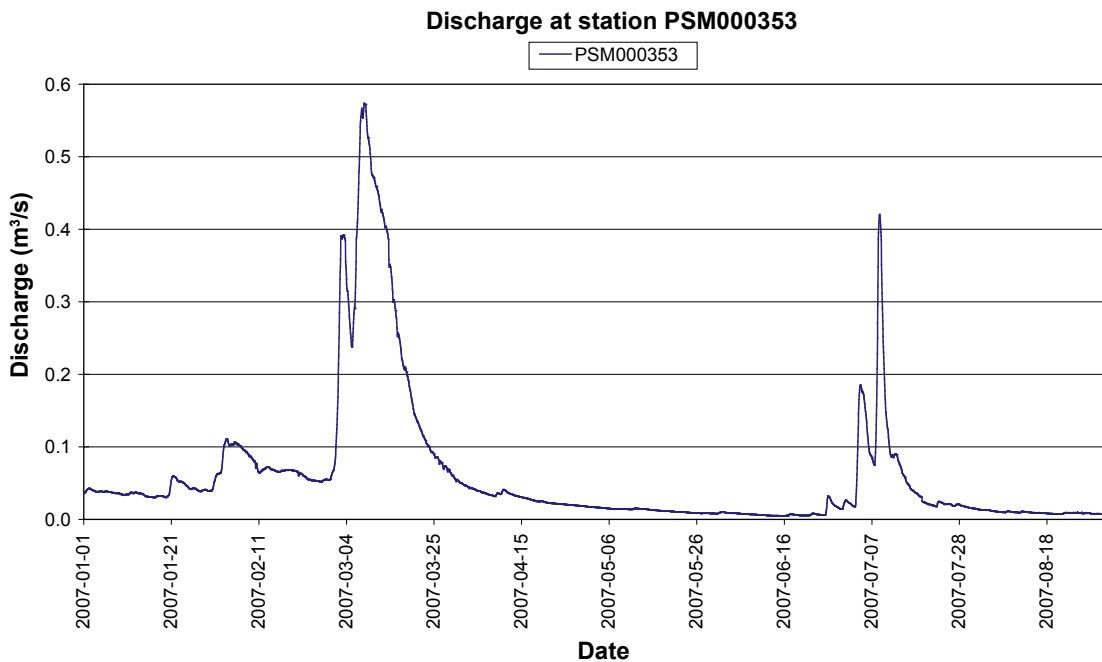

Figure 5-4. Quality assured discharge, m<sup>3</sup>/s, for station PSM000353.

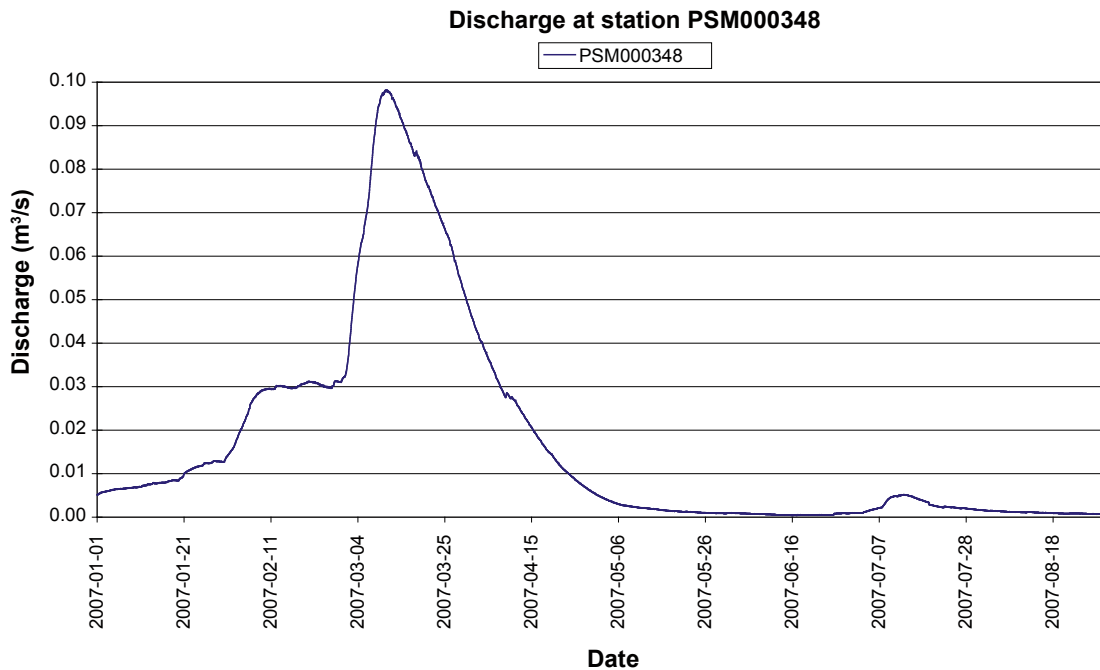

Figure 5-5. Quality assured discharge, m<sup>3</sup>/s, for station PSM000348.

## 5.1.2 Water level

### Sea water level

Sea water level is measured at three places in the surroundings of Äspö. The stations are PSM000369, PSM000370 and PSM000371. Measurements are made in elevation system RT90-RHB70 and expressed as metres above sea level (m.a.s.l.). The similarity between measurements at the three stations is good. The results are presented in Figure 5-6. It has not been necessary to make any corrections of measured values during time of measurements.

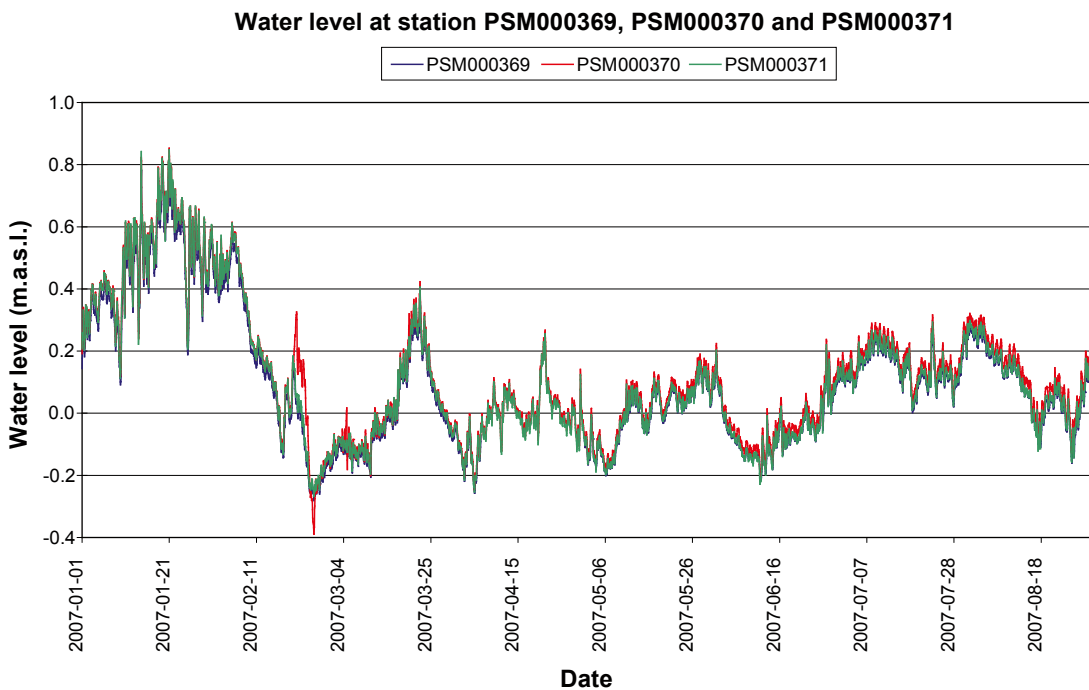

Figure 5-6. Sea water level measured at station PSM000369, PSM000370 and PSM000371. All measurements made in elevation system RT90-RHB70.

### Water level measured in lakes and reservoirs

Water level is also taken at station PSM000342 and PSM000344. At PSM000342 water level is measured in lake Jämsen and at station PSM000344 in lake Plittorpsgöl. All measurements are in elevation system RT90-RHB70. At PSM342 daily fluctuations has occurred periodically from March to August. As no reasonable explanation to this has risen, another sensor will be used as a complement to detect any possible malfunction in the equipment. No corrections of data during the period has been made. The measured water levels can be seen in Figure 5-7.

At station PSM000359 water level is measured in the reservoir at Sörå. Measurements are in metres above sea level (m.a.s.l.), in elevation system RT90-RHB70. The measured water level can be seen in Figure 5-8. No corrections of data has been made.

### Water level measured in streams

Measurement of water level is made at two locations along the the Ekerumsån. The stations were initially installed for specific activities to investigate the soil-rock transition zone but were eventually made permanent.

### 5.1.3 Water temperature and electrical conductivity, (EC)

At all stations monitoring discharge the water temperature and electrical conductivity, EC, are measured. At the stations PSM000341, PSM000343 and PSM000345 where constructed dams are made, temperature and EC is measured in the small basin upstream the concrete dam. During drought, in periods when discharge in creeks equals zero, the water temperature in the basins will increase and the logged temperature and EC values will therefore not be representative. For this reason, all quality checked temperature and EC values are deleted when the discharge equals zero. Temperature measurements have worked well during the whole period and no temperature adjustments have been made. At the station inspection made by SMHI 2007-05-21 to 2007-05-23, all loggers were checked (except PSM000343 where the watercourse was dried up) in relation to a reference thermometer and no significant errors were detected.

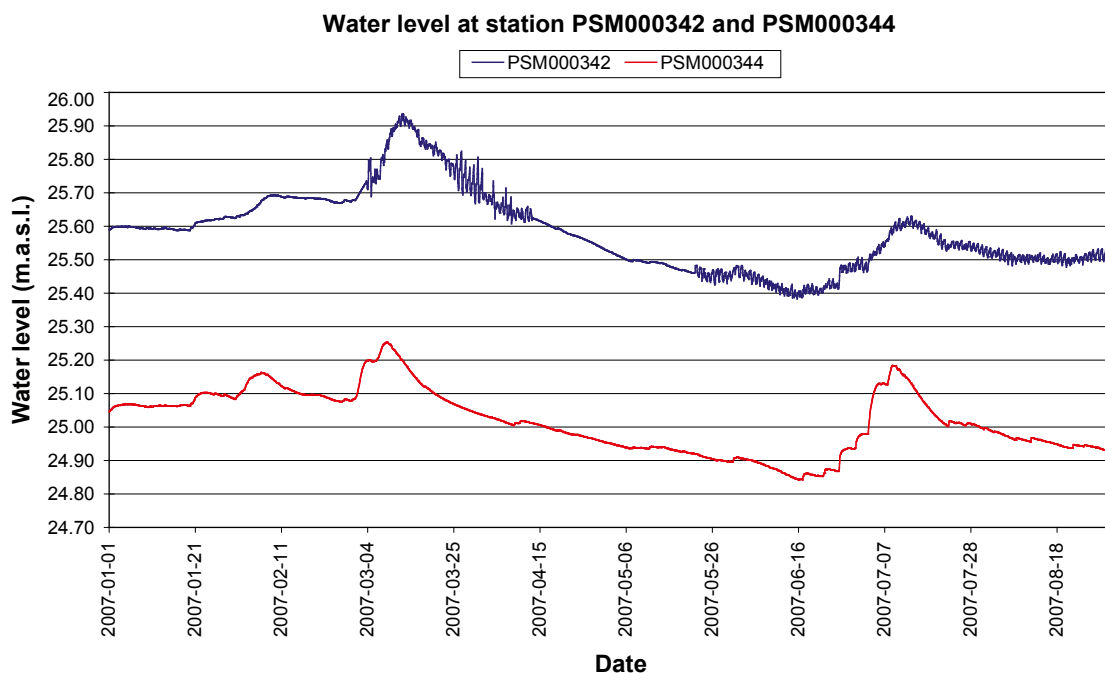

**Figure 5-7.** Water level measured at station PSM000342 and PSM000344. The blue line shows the development of water level for lake Jämsen and the red line for lake Plittorpsgöl. Measurements made in meter above sea level (m.a.s.l.).

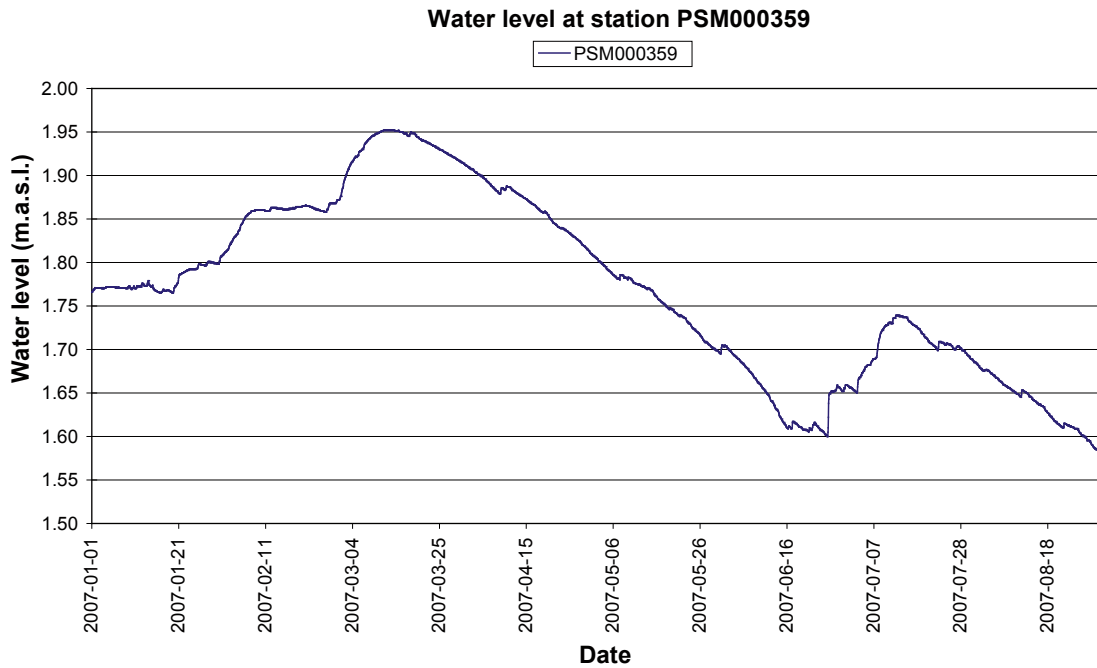

**Figure 5-8.** Water level measured in m.a.s.l. at station PSM000359. The blue line shows the development of water level in the reservoir at Sörå.

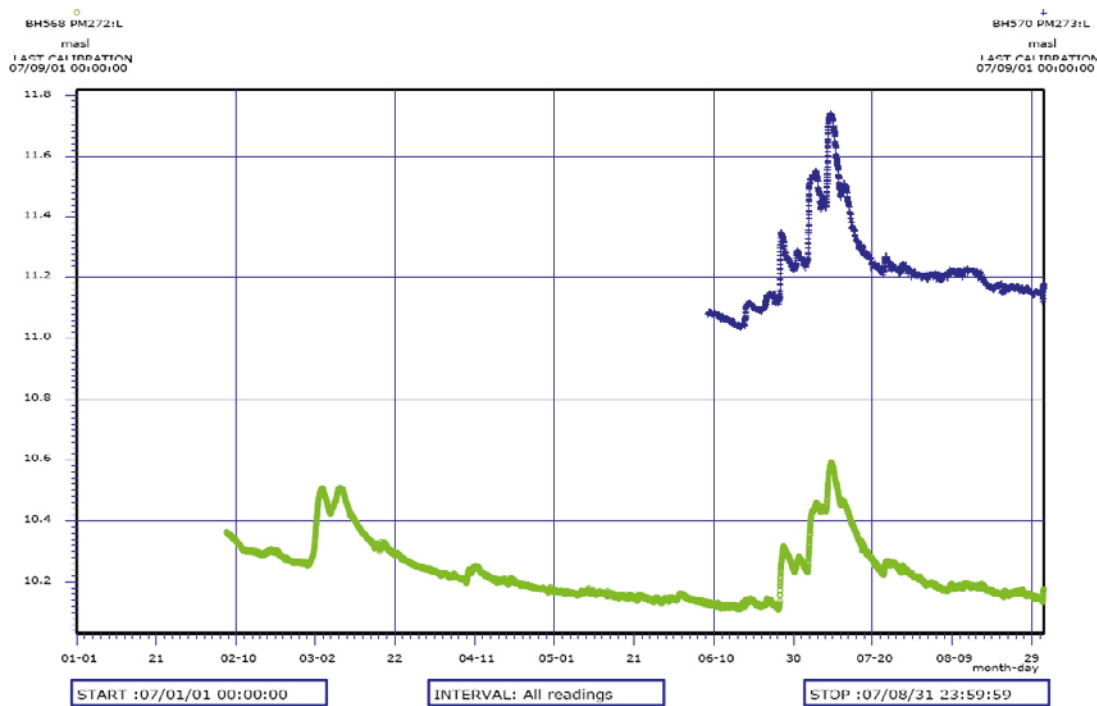
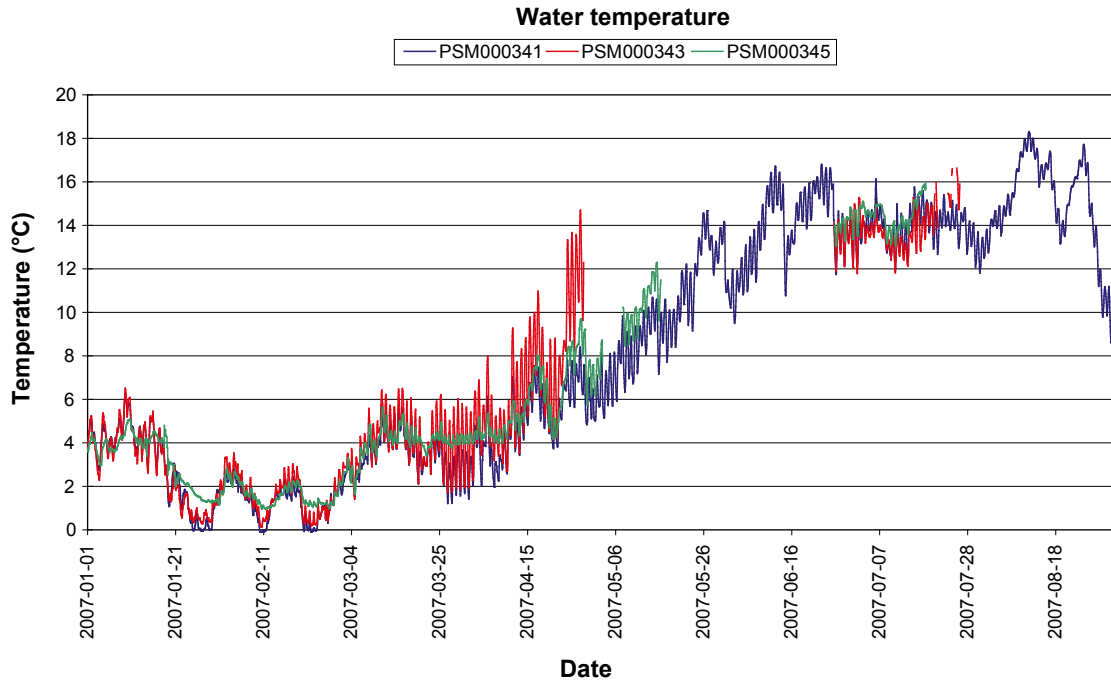

**Figure 5-9.** Water level measured at station PSM000272 and PSM000273. The blue line shows the development of water level for PSM000273 which is located upstream of PSM000272 in green. Measurements are given in metres above sea level (m.a.s.l.).

It has been necessary to adjust conductivity measurements at PSM000345 when extremely high values occurred. At stations PSM000348, PSM000353, PSM000364 and PSM000368 all sensors are situated in a creek or in a lake. Also here adjustments of conductivity has been necessary to make when some strange and deviating values occurred. The sensors seem to be covered with organic material during the vegetation period when the biological activity is high. Because of this, it is very important to keep the sensor clean during this part of season.

All adjustments made have likely been caused by increasing growth of organic material on sensors. After cleaning the sensors, they have showed correct values. At the station inspection made by SMHI 2007-05-21 to 2007-05-23, water specimen were taken at all stations (except PSM000343 where the watercourse was dried up) and later analysed by SKB laboratory regarding electrical conductivity. No significant errors were detected.

Quality checked measurements are presented in Figures 5-10 to 5-17.



**Figure 5-10.** Water temperature measured at stations PSM000341, PSM000343 and PSM000345. Values deleted during periods when the discharge equals zero or when the watercourse is dried up.

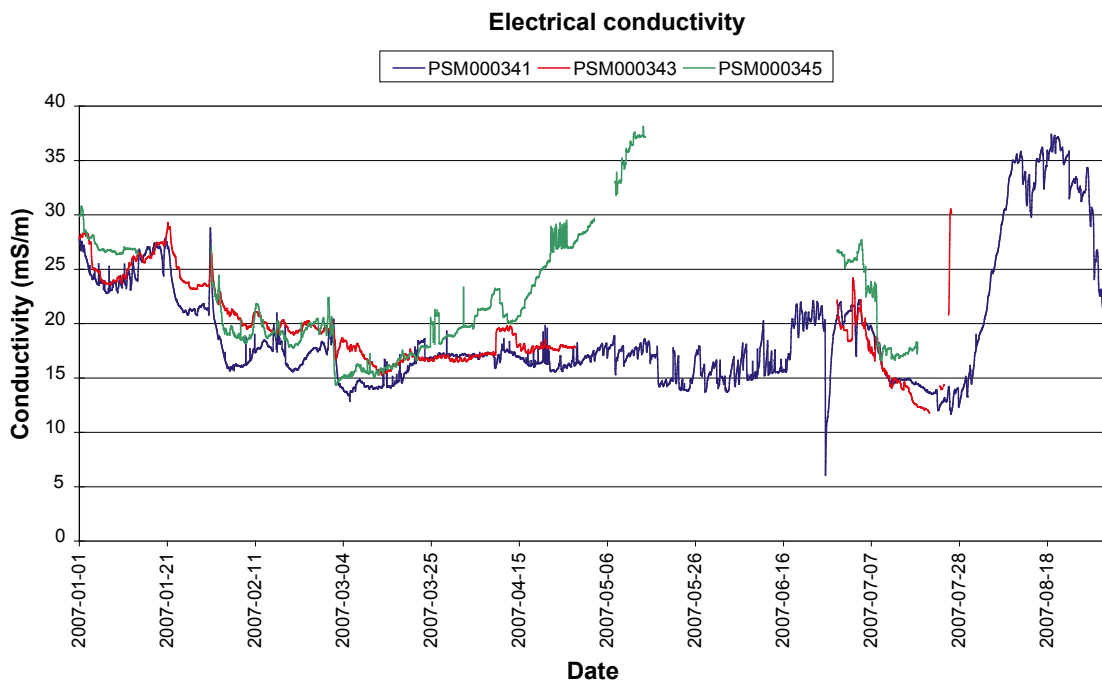

**Figure 5-11.** Electrical conductivity, EC, measured at stations PSM000341, PSM000343 and PSM000345. Values deleted during periods when the discharge equals zero or when the watercourse is dried up. Extremely high values at station PSM000345 corrected.

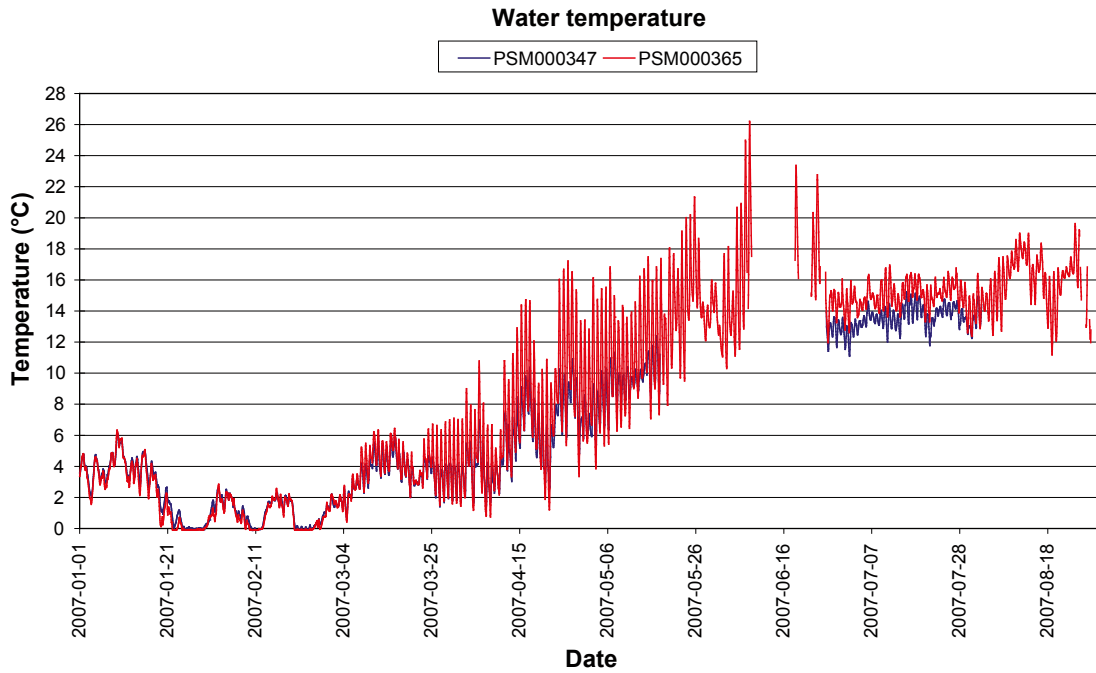

**Figure 5-12.** Water temperature measured at stations PSM000347 and PSM000365. Values deleted during periods when the discharge equals zero or when the watercourse is dried up.

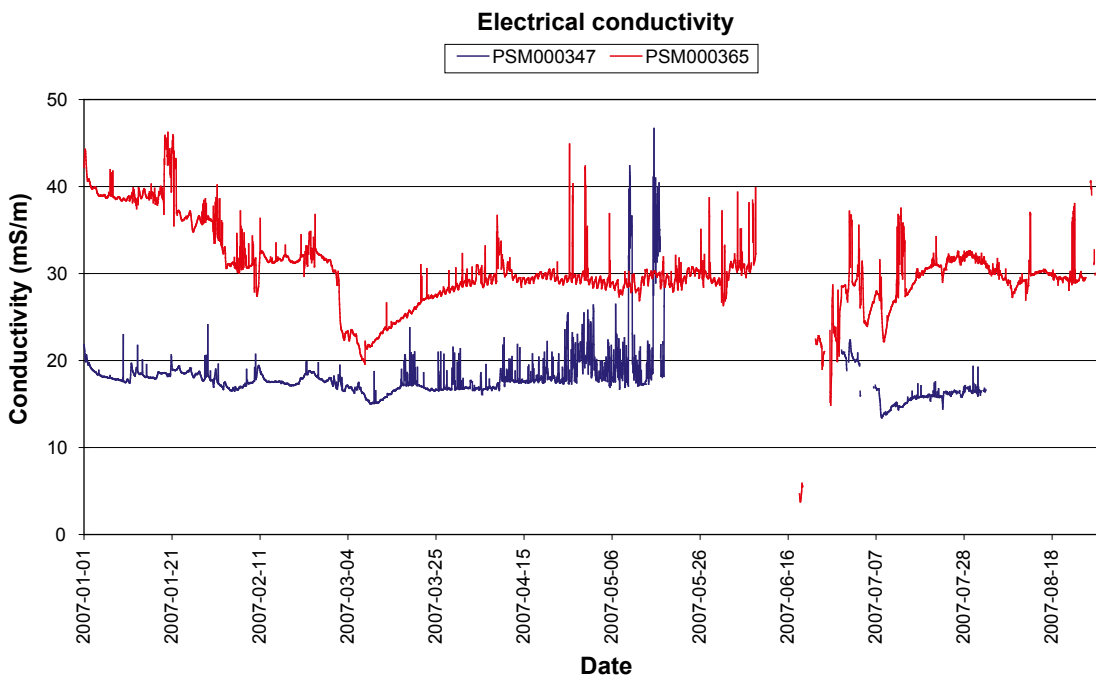

**Figure 5-13.** Electrical conductivity, EC, measured at stations PSM000347 and PSM000365. Values are deleted during periods when the discharge equals zero or when the watercourse is dried up. Extremely high and low values at station PSM000347 corrected.

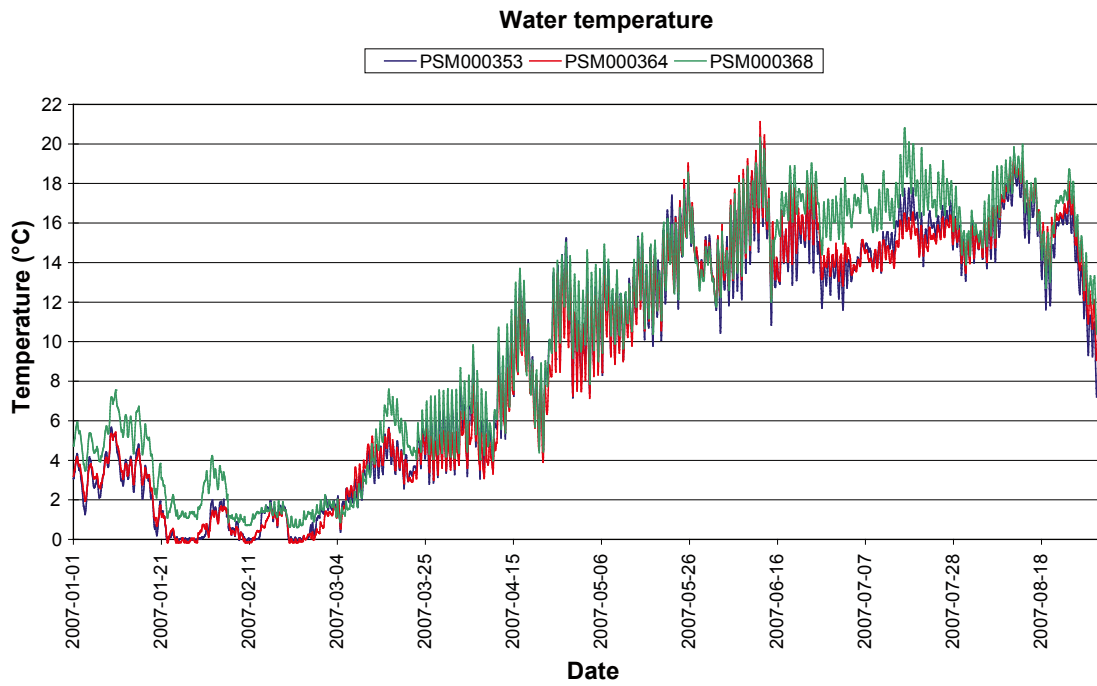

Figure 5-14. Water temperature measured at stations PSM000353, PSM000364 and PSM000368.

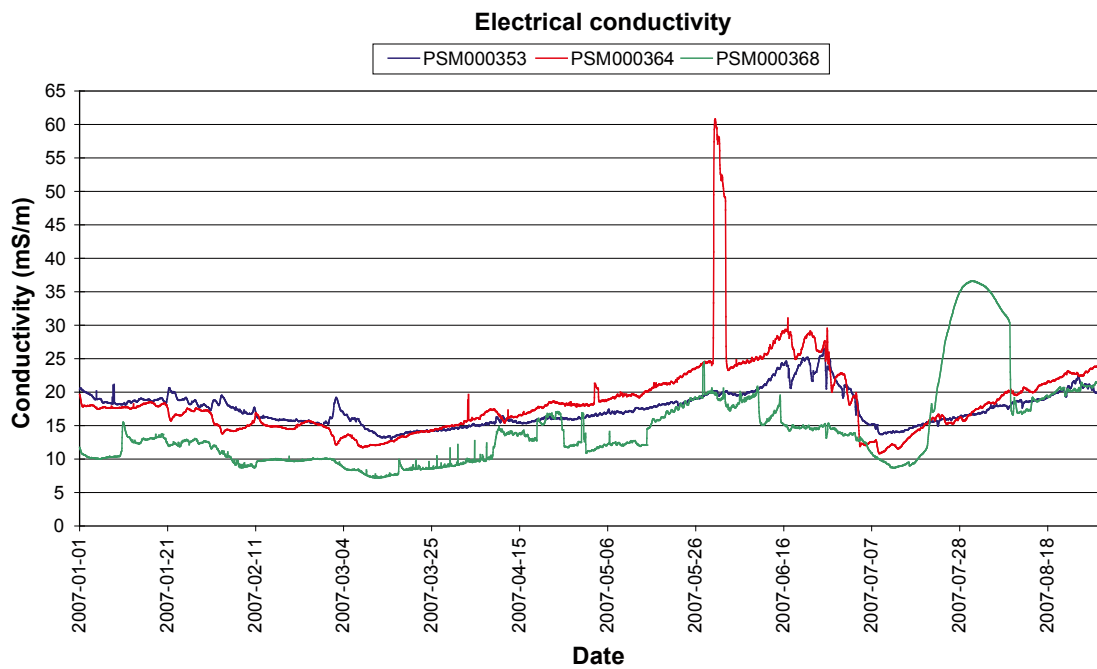

Figure 5-15. Electrical conductivity measured at station PSM000353, PSM000364 and PSM000368. Extremely high and low values corrected.

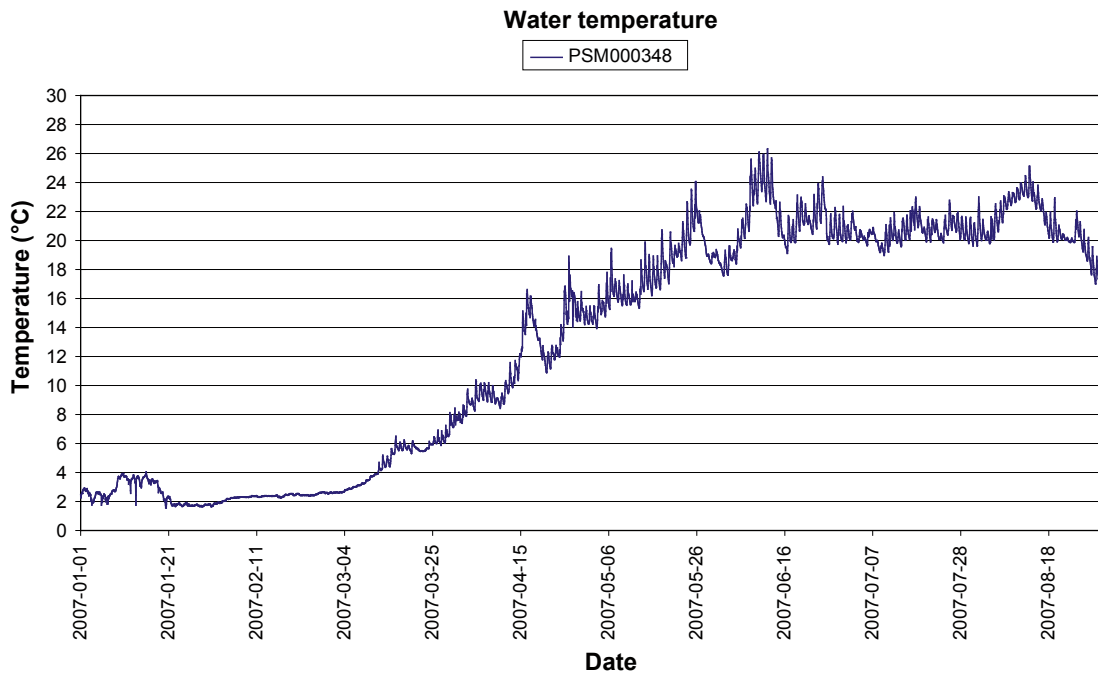

Figure 5-16. Water temperature measured at Lake Frisksjön station PSM000348.

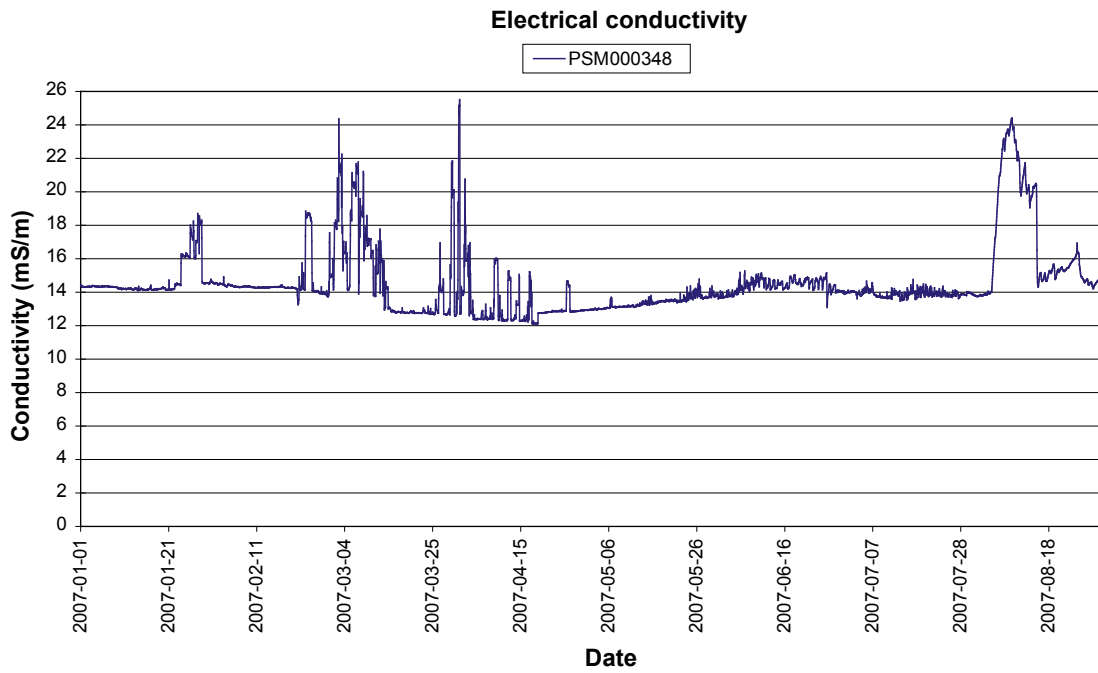

Figure 5-17. Electrical conductivity measured at Lake Frisksjön station PSM000348. Extremely high values corrected.



## 5.2 Meteorological monitoring

Figure 4-2 shows where the two monitoring stations Plittorp and Äspö are situated. The figure also shows where the SMHI's regional precipitation stations presented in this report below are located.

### 5.2.1 Precipitation

The monthly precipitations for SMHI's stations are presented in Table 5-2 and Figure 5-18 below. "Ölands Norra Udde A" and "Gladhammar A" are automatic stations and the others are manual stations. These precipitation values are all controlled and approved by SMHI. There are no correction for wind errors, wetting and evaporation in these values in Table 5-2a but in Table 5-2b corrected values are presented. We see that the precipitation differs a lot between stations and between months.

The correction of precipitation is listed below in Table 5-1.

**Table 5-1. ALX-Corrections in percent of SMHI's stations according to reference /5/.**

	Jan	Feb	Mar	Apr	May	Jun	Jul	Aug	Sep	Oct	Nov	Dec	Year
Målilla	7	9	6	8	7	8	6	7	7	6	6	6	7
Oskarshamn	6	6	6	8	8	11	8	7	7	7	6	6	7
Krokshult	9	11	9	8	10	12	9	10	8	8	8	8	9
Krånemåla	7	9	9	8	9	10	8	9	8	8	7	6	8
Ölands norra A	18	22	16	16	13	16	15	16	16	16	18	18	17
Ölands norra	13	14	17	12	13	16	15	11	12	14	11	11	13
Gladhammar A	13	15	14	14	22	12	13	13	13	12	13	16	13

**Table 5-2a. Monthly precipitation in mm at SMHI's stations, uncorrected.**

	jan-07	feb-07	mar-07	apr-07	maj-07	jun-07	jul-07	aug-07	Total
Målilla	65	55	24	17	31	117	105	75	489
Oskarshamn	46	55	21	17	33	102	120	43	437
Krokshult	54	61	26	16	33	112	122	90	514
Krånemåla	74	64	27	19	32	91	91	43	441
Gladhammar	62	50	31	18	32	121	112	47	471
Ölands norra udde A	52	38	25	10	16	42	83	55	322
Ölands norra udde	39	36	24	9	14	37	64	56	279

**Table 5-2b. Monthly precipitation in mm at SMHI's stations, corrected (ALX).**

	jan-07	feb-07	mar-07	apr-07	maj-07	jun-07	jul-07	aug-07	Total
Målilla	70	60	26	18	33	126	111	80	524
Oskarshamn	49	58	22	18	35	114	129	46	472
Krokshult	59	67	28	18	37	125	132	99	566
Krånemåla	79	70	29	21	35	100	99	47	479
Gladhammar	69	57	35	20	39	135	126	53	535
Ölands norra udde A	62	46	29	12	18	49	95	64	375
Ölands norra udde	44	41	28	10	16	43	73	62	318

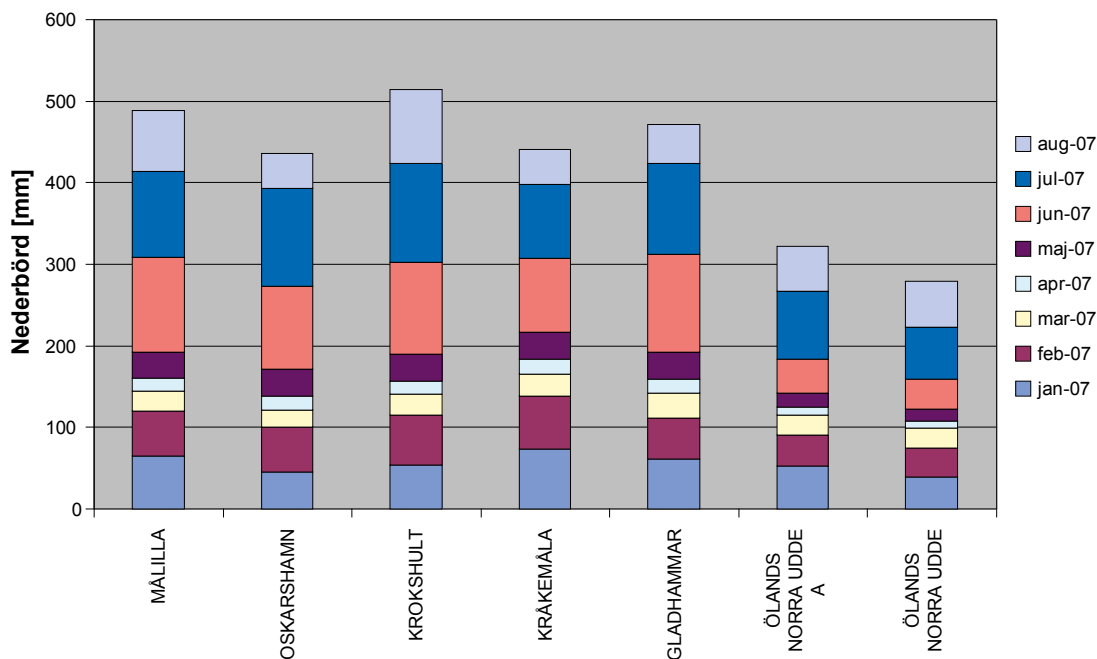

Figur 5.18a. Monthly precipitation in mm at SMHI's stations, uncorrected.

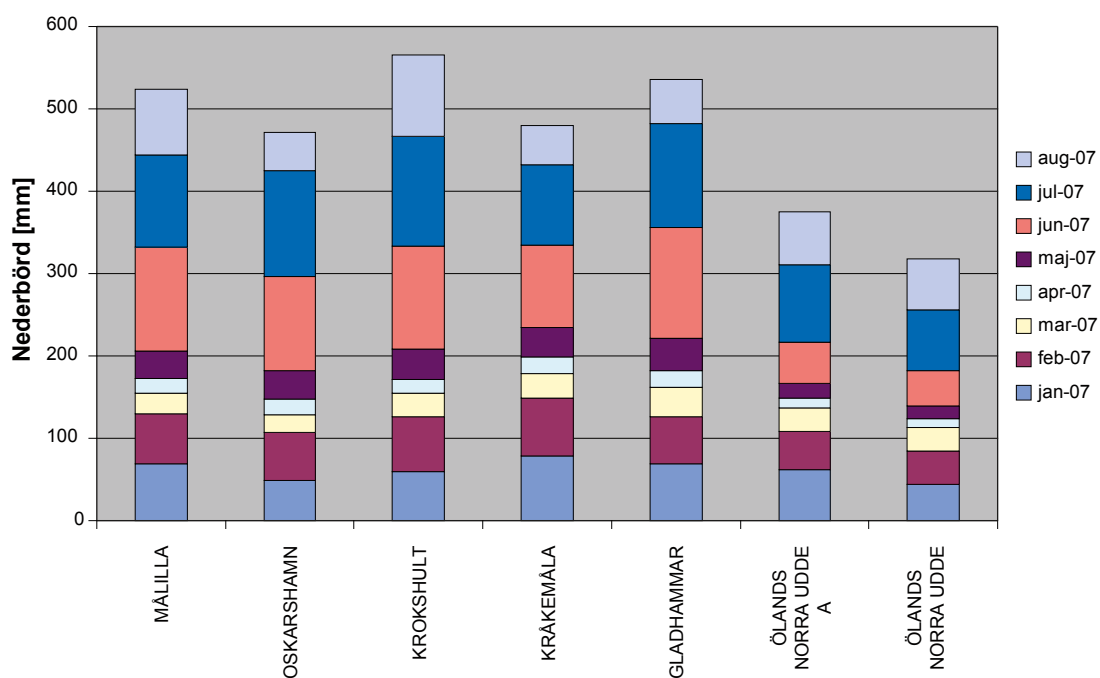

Figur 5.18b. Monthly precipitation in mm at SMHI's stations, corrected (ALX).

The precipitation at Plittorp and Äspö are presented in Table 5-4. "001" in the table means originally measured value from the Geonor precipitation gauge, "COR" means corrected and approved value by SMHI, "BUC" means values from a precipitation gauge of the type tipping bucket and "MES" means analysed values from Mesan. ALX is the correction for wind errors, wetting and evaporation. "BUC"-data is from another gauge and are not a part of this project. SMHI is not responsible for this instrument.

ALX is estimating the true precipitation. It is based on photographs of the surroundings and maps of the stations and the same method is used as for the other SMHI stations. The Table 5-3 below gives the corrections in percent for each month. More information about the estimated true precipitation can be found in reference /5/ and /6/.

**Table 5-3. ALX-Corrections in percent of SKB's stations according to reference /6/.**

	Jan	Feb	Mar	Apr	May	Jun	Jul	Aug	Sep	Oct	Nov	Dec	Year
Äspö	21	21	19	16	14	14	14	14	14	16	17	20	17
Plittorp	12	13	12	10	10	9	9	10	10	10	10	12	11

**Table 5-4. Monthly precipitation in mm at SKB's stations. "001" in the table means originally measured value, "COR" means corrected and approved value by SMHI and "MES" means analysed values from Mesan. ALX is the new estimation of the true precipitation and "BUC" means values from a precipitation gauge of the type tipping bucket.**

	jan-07	feb-07	mar-07	apr-07	maj-07	jun-07	jul-07	aug-07	Total
Äspö 001	55.0	42.9	24.4	15.5	38.7	90.3	84.0	41.9	392.7
Äspö COR	55.0	42.9	24.4	14.8	38.8	90.3	84.0	41.9	392.1
Äspö MES	47.0	36.8	28.4	14.9	27.8	73.1	97.7	41.7	367.3
Äspö ALX	66.5	51.9	29.0	17.2	44.2	102.9	95.8	47.8	455.4
Äspö BUC	13.6	27.4	3.4	16.8	18.4	88.8	87.2	45.4	301.0
Plittorp 001	56.8	51.4	22.7	15.2	37.0	111.4	107.0	48.9	450.4
Plittorp COR	56.8	51.4	22.7	14.7	37.2	111.4	107.0	48.9	450.1
Plittorp ALX	63.6	58.1	25.4	16.2	40.9	121.4	116.6	53.8	496.1

The registered 30-minutes precipitation values have to be filtered before storing. That is because the instrument is very sensitive and registers incorrect small values of precipitation.

If we compare the corrected values from Plittorp and Äspö (450 and 392 mm), with the values from the closest SMHI stations Kråkemåla and Oskarshamn 479 mm and 472 mm) we see that Plittorp correspond quite well with the two SMHI stations.

Figure A5-1 in Appendix 5 shows the accumulated sum of precipitation during the period. From the figure, we see that the precipitation gauge was emptied in April 2007.

### 5.2.2 Barometric pressure

Graphs of the barometric pressure are presented in Figure A5-2 in Appendix 5. Values from Plittorp, Äspö and Mesan-values are presented. Figure A5-10 shows 30-min values for January 2007 where we can see that the measured value from Plittorp is lower than the Mesan-value, which is valid for the sea surface. The pressure decreases in theory about 1 hPa per 8 metres and the value from Plittorp is therefore correct.

### 5.2.3 Air temperature

Graphs of daily temperature are presented in Figure A5-3 in Appendix 5. Values from Plittorp, Äspö and Mesan-values are presented. We see that the three curves follow each other very well.

Figure A5-11 shows 30-min values for January 2007. We notice that Äspö is more influenced of the sea because the lowest temperatures are several degrees higher compared to Plittorp.

### 5.2.4 Relative humidity

Graphs of daily relative humidity are presented in Figure A5-4 in Appendix 5. Values from Plittorp, Äspö and Mesan-values are presented. We see that the three curves follow each other very well. In Figure A5-12, 30-min values for January 2007 are presented.

### 5.2.5 Wind speed

Graphs of the wind speed (daily mean) are presented in Figure A5-5 in Appendix 5. Values from Plittorp, Äspö and Mesan-values are presented. We see that the wind speeds are higher at Äspö compared to Plittorp but that the curves follow each other quite well.

The measured wind speed at Plittorp is clearly lower than the Mesan analysis. This depends on the surroundings of the site (not very open area) and that Mesan overestimates the wind speed at sites close to the sea. The measured wind speed at Plittorp is also lower than the values from Äspö. The reason is of course that Äspö is closer to the sea.

Figure A5-13 shows measurements for January 2007 for the 30-min mean wind speed. The gust wind speed is approximately 2–3 times higher than the mean wind speed presented here. The gust wind speed is not presented in the figure.

### 5.2.6 Wind direction

Graphs of the wind direction are presented in Figure A5-6 in Appendix 5. Values from Äspö, Plittorp and Mesan-values are presented. We see that the two curves follow each other very well. Figure A5-14 shows 30-min values for January 2007.

### 5.2.7 Global radiation

Graphs of the daily sum of global radiation are presented in Figure A5-7 in Appendix 5. Global radiation is measured only at Äspö. Values from Äspö and Strång-values are presented. Analysed global radiation from the SMHI radiation model Strång, which uses data from Mesan, corresponds well to measured global radiation at Äspö. 30-min values for January 2007 are presented in Figure A5-15.

### 5.2.8 Calculated evapotranspiration

The potential evapotranspiration  $E_p$  “new calculation method” is derived from the Penman equation:

$$E_p = \left( \frac{\Delta \cdot (R_n - G)}{(\Delta + \gamma) \cdot L} + \frac{\gamma \cdot f(u) \cdot (e_s - e)}{(\Delta + \gamma)} \right) \cdot tstep$$

where

- $\Delta$  proportionality constant
- $R_n$  net radiation flux density
- $G$  heat flux density into ground
- $\gamma$  psychrometric constant
- $f(u)$  function of wind speed
- $e_s$  saturated water vapor pressure
- $e$  water vapor pressure
- $L$  latent heat of vaporization
- $tstep$  time step

The method is described in detail in Eriksson B, 1981 /4/. Measured data every 30-minutes of temperature, relative humidity, wind speed and global radiation were required as input data to the equation to calculate the potential evapotranspiration. The wind speed was measured at 10 m above the ground but for the estimation of potential evapotranspiration the wind speed was re-calculated to a value representing 2 m above the ground by multiplying by a factor 0.8. The net radiation was calculated from the measured global radiation and the albedo was set to 0.12 when the ground was not covered in snow and to 0.5 when there was a snow cover. The applied method included heat storage in the ground.

Graph of the potential evapotranspiration is presented in the Figure A5-8 in Appendix 5. The 30-min values for January 2007 are presented in Figure A5-1 in Appendix 5.

## 5.3 Winter parameters

### 5.3.1 Snow depth

The average snow depth at the one station for snow depth measurement is shown in Figure 5-19. The complete set of primary data is presented in Appendix 3, Table A3-1.

### 5.3.2 Frost in ground

The frost in ground together with snow depth at “Grillplatsen” (PSM107724) is shown in Figure 5-20. The complete sets of primary data is shown in Appendix 4, Table A4-1 and A4-2.

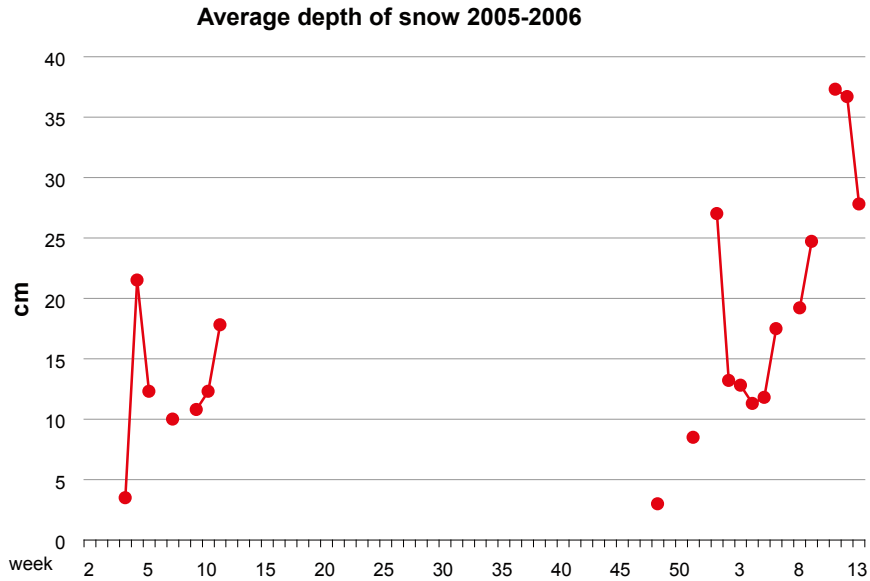

Figure 5-19. Average snow depth at Äspö 2 (ASM100224) during the winter 2005/2006.

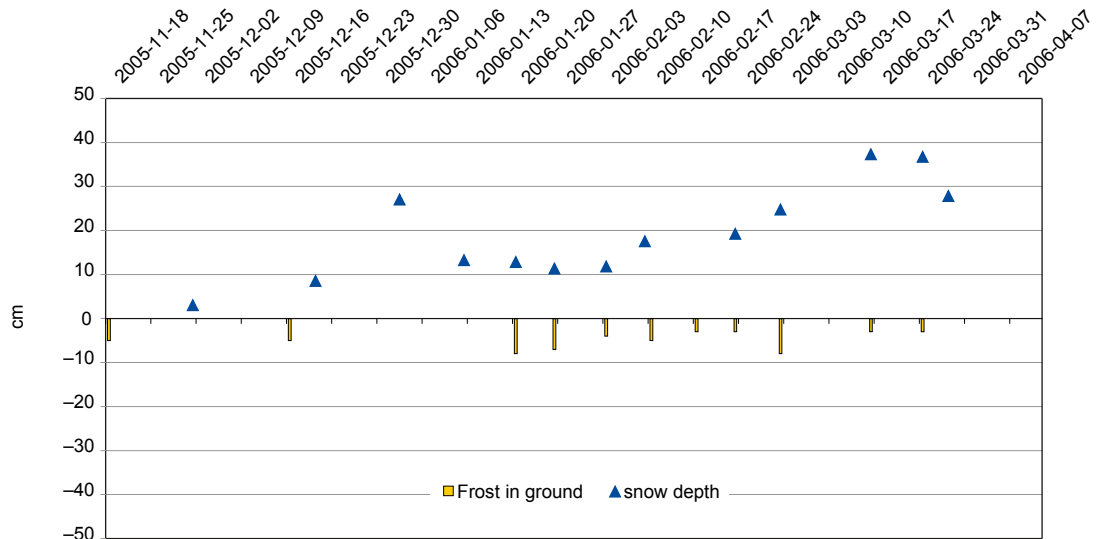

Figure 5-20. Calculated frost in ground and snow depth at PSM107724 during 2005 and 2006.

### 5.3.3 Ice cover

Ice conditions observed in the Oskarshamn area are shown in Table 5-5.

**Table 5-5. Time for ice freeze up and ice break up in a lake and sea at the Oskarshamns area<sup>1</sup>.**

Site	Ice freeze up	Ice break up	Period with ice cover (days)
Äspös brygga (ASM10226)	2002-12-19	2003-03-27	99
	2004-01-07	2004-03-10	62
	2005-03-08	2005-04-01	25
	2005-12-20	2006-04-18	119
Kråkelund yttre (ASM100227)	no ice cover during 2003–2004		
	no ice cover during 2004–2005		
	no ice cover during 2005–2006		
Kråkelund inre (ASM100228)	2003-01-10	2003-03-21	71
	no ice cover during 2004–2005		
	2006-01-02	2006-01-12	10
	2006-01-26	2006-02-03	8
	2006-03-17	2006-03-29	12
Jämsen (ASM100229)	2002-11-19	2002-11-22	3
	2002-12-19	2003-03-28	100
	2004-01-07	2004-03-10	64
	2004-11-22	2005-03-30	129
	2005-11-22	2006-04-18	147

<sup>1</sup> This table replaces Table 5-3 in report P-06-19 and Table 5-3 in report P-05-227 due to error in ice cover data for ASM100227 (Kråkelund yttre).

## References

- /1/ **SMHI/Naturvårdsverket, 1979.** Vattenföringsbestämning vid vattenundersökningar.
- /2/ **SMHI, Handbok för observatörer.** Internt document.
- /3/ **SKB, 2002.** Instruktion för inmätning och avvägning av objekt. SKB MD 110.001, Svensk Kärnbränslehantering AB.
- /4/ **Eriksson B, 1981.** Den ”potentiella” evapotranspirationen i Sverige. Eriksson, B. (1981) RMK28.
- /5/ **Alexandersson, 2003.** Meteorologi, Nr111. Korrektion av nederbörd enligt enkel klimatologisk metodik.
- /6/ **Alexandersson, 2005.** Enkel bedömning av nederbördsrätningsförluster på fyra automatstationer.

## Hydrological monitoring stations

Station Id	Object	Place	Variables	Instrumentation	Time interval of measurements	QC_OK
PSM000341	Ävrö NE	Dam	Discharge, T, EC	Logger: Campbell CR10X  Pressure sensor: DRUCK PDCR 1830  Temp. and EC: Campbell CS547	Start: 2004-03-18 00:00  Stop: 2007-09-01 00:00	OK
PSM000342	Jämsen	Lake	Water level	Logger: Campbell CR510  Pressure sensor: DRUCK PDCR 1830	Start: 2004-07-24 15:00  Stop: 2007-09-01-00:00	OK
PSM000343	Ävrö SW	Dam	Discharge, T, EC	Logger: Campbell CR10X  Pressure sensor: DRUCK PDCR 1830  Temp. and EC: Campbell CS547	Start: 2004-03-18 00:00  Stop: 2007-09-01 00:00	OK
PSM000344	Plittorpsgöl	Lake	Water level	Logger: Campbell CR510  Pressure sensor: DRUCK PDCR 1830	Start: 2004-07-24 15:00  Stop: 2007-09-01 00:00	OK
PSM000345	Ävrö SE	Dam	Discharge, T, EC	Logger: Campbell CR10X  Pressure sensor: DRUCK PDCR 1830  Temp. and EC: Campbell CS547	Start: 2004-03-18 00:00  Stop: 2007-09-01 00:00	OK
PSM000347	Frisksjön(in)	Dam	Discharge, T, EC	Logger: Campbell CR10X  Pressure sensor: DRUCK PDCR 1830  Temp. and EC: Campbell CS547	Start: 2004-11-30 13:00  Stop: 2007-09-01 00:00	OK
PSM000348	Frisksjön (out)	Lake, Natural section	Discharge, T, EC	Logger: Campbell CR10X  Pressure sensor: DRUCK PDCR 1830  Temp. and EC: Campbell CS547	Start: 2004-07-24 01:00  Stop: 2007-09-01 00:00	OK
PSM000353	Laxemarån (upper)	Natural section	Discharge, T, EC	Logger: Campbell CR10X  Pressure sensor: DRUCK PDCR 1830  Temp. and EC: Campbell CS547	Start: 2004-09-02 15:00  Stop: 2007-09-01 00:00	OK
PSM000359	Söråmagasinet	Lake	Water level	Logger: Campbell CR510  Pressure sensor: DRUCK PDCR 1830	Start: 2004-01-28 17:00  Stop: 2007-09-01 00:00	OK



Station Id	Object	Place	Variables	Instrumentation	Time interval of measurements	QC_OK
PSM000364	Laxemarån (lower)	Natural section	Discharge, T, EC	Logger: Campbell CR10X Pressure sensor: DRUCK PDCR 1830 Temp. and EC: Campbell CS547	Start: 2004-09-02 11:00 Stop: 2007-09-01 00:00	OK
PSM000365	Ekerumsån	Dam	Discharge, T, EC	Logger: Campbell CR10X Pressure sensor: DRUCK PDCR 1830 Temp. and EC: Campbell CS547	Start: 2005-02-01 13:00 Stop: 2007-09-01 00:00	OK
PSM000368	Kärrviksån	Natural section	Discharge, T, EC	Logger: Campbell CR10X Pressure sensor: DRUCK PDCR 1830 Temp. and EC: Campbell CS547	Start: 2004-07-24 10:00 Stop: 2007-09-01 00:00	OK
PSM000369	Äspö S	Sea	Water level	Logger: Campbell CR510 Pressure sensor: DRUCK PDCR 1830	Start: 2004-01-28 17:00 Stop: 2007-09-01 00:00	OK
PSM000272	Ekerumsån	Stream	Water level	Combined logger and pressure sensor: MiniTroll 30PSIA	Start: 2007-02-07 17:00 Stop: 2007-09-01 00:00	
PSM000273	Ekerumsån	Stream	Water level	Combined logger and pressure sensor: MiniTroll 30PSIA	Start: 2007-06-08 17:00 Stop: 2007-09-01 00:00	
PSM000370	Äspö N	Sea	Water level	Logger: Campbell CR510 Pressure sensor: DRUCK PDCR 1830	Start: 2004-01-28 17:00 Stop: 2007-09-01 00:00	OK
PSM000371	Clab	Sea	Water level	Logger: Campbell CR510 Pressure sensor: DRUCK PDCR 1830	Start: 2004-01-28 17:00 Stop: 2007-09-01 00:00	OK

## Rating curves for hydrological stations

### Rating curves where concrete V-notch is used

The following rating curves are based on control measurements made by SKB and SMHI and were determined 2006-10-01. Since then additional control measurements have been made by SKB. However, these have not given any occasion to adjust existing curves, but further control measurements of discharge are required to increase the accuracy of the rating curves. The names of the five stations are PSM000341, PSM000343, PSM000345, PSM000347 and PSM000365.

For all stations the discharge has been theoretically calculated as:

$$Q = 8/15 \cdot \mu \cdot (2g)^{1/2} \cdot h^{5/2} \cdot \tan \alpha / 2$$

Q = Discharge (m<sup>3</sup>/s)

μ = Coefficient approximatively constant

g = Constant of gravity (9.815 m/s<sup>2</sup>)

h = Water level above V-notch (m)

α = opening angle

#### PSM000341

The rating angle is 45° and μ is set to 0.7. This value of μ is somewhat high because the water speed is high through the dam. The diagram below shows how the control measurements fit to the theoretically calculated discharge Q.

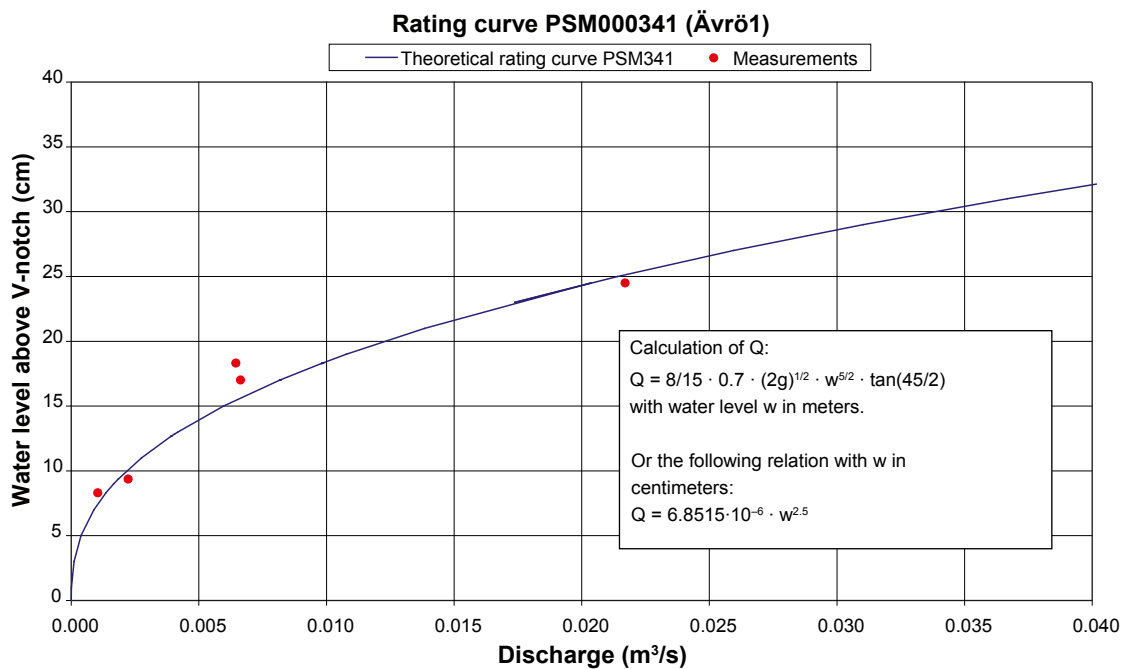

**Figure A2-1.** Made control measurements in relation to the theoretically calculated discharge at PSM000341.

**PSM000343**

The rating angle is 45° and  $\mu$  is set to 0.6. The diagram below shows how the control measurements fit to the theoretically calculated discharge Q.

**PSM000345**

The rating angle is 45° and  $\mu$  is set to 0.6. The diagram below shows how the control measurements fit to the theoretically calculated discharge Q.

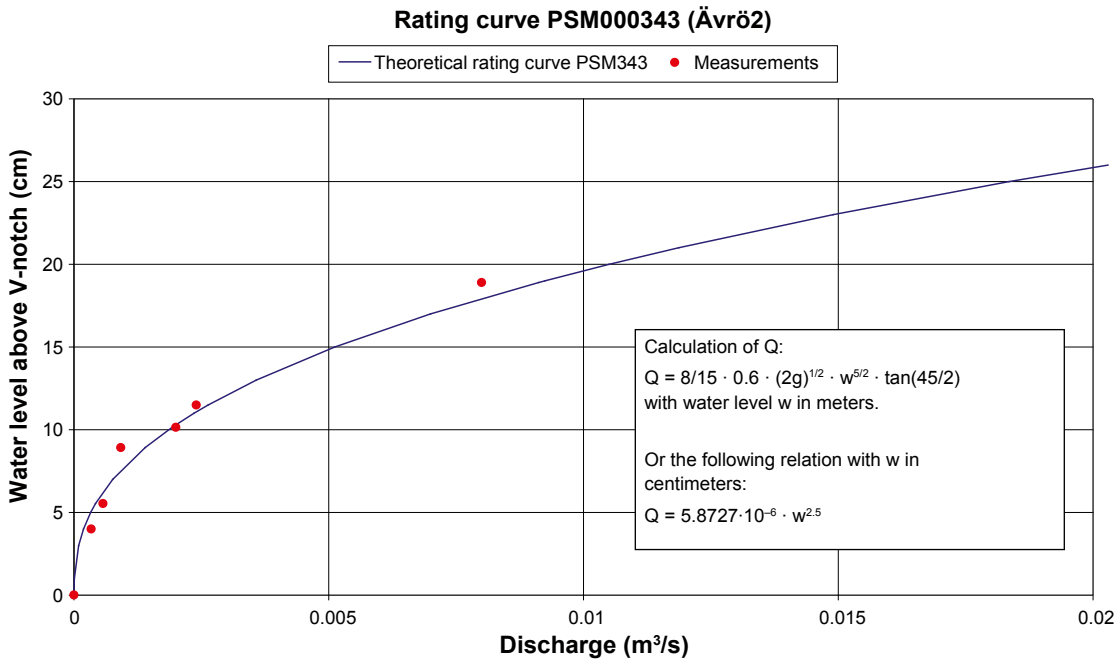

Figure A2-2. Made control measurements in relation to the theoretically calculated discharge at PSM000343.

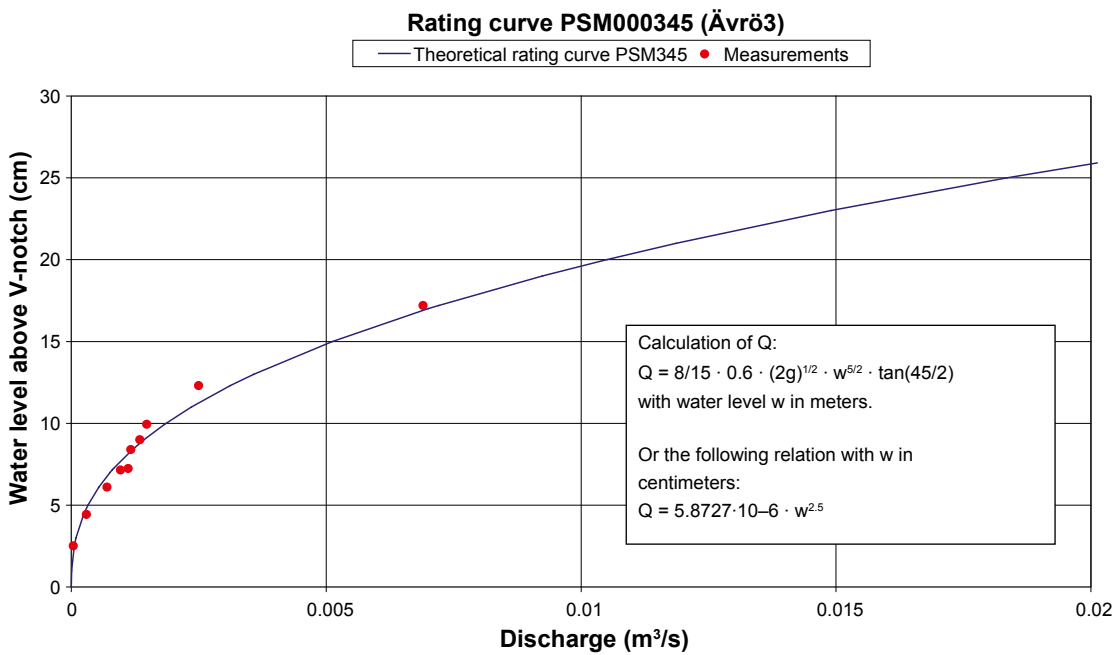

Figure A2-3. Made control measurements in relation to the theoretically calculated discharge at PSM000345.

### PSM000347

The rating angle is 60° and  $\mu$  is set to 0.6. The diagram below shows how the control measurements fit to the theoretically calculated discharge Q.

### PSM000365

The rating angle is 120° and  $\mu$  is set to 0.6. The diagram below shows how the control measurements fit to the theoretically calculated discharge Q.

Rating curves where natural cross section is used The following rating curves are based on control measurements made by SKB and SMHI to describe the discharge at the SKB hydrological stations where a natural cross section in the watercourse is used. The rating curves were determined 2006-10-01. Since then additional control measurements have been made by SKB. However, these have not given any occasion to adjust existing curves, but further control measurements of discharge are required to increase the accuracy of the rating curves. The names of the four stations are PSM000348, PSM000353, PSM000364 and PSM000368.

### PSM000348

The discharge from lake Frisksjön is determined by using the lake's natural outlet as cross section. The rating curve below has been established based on control measurements made up to now.

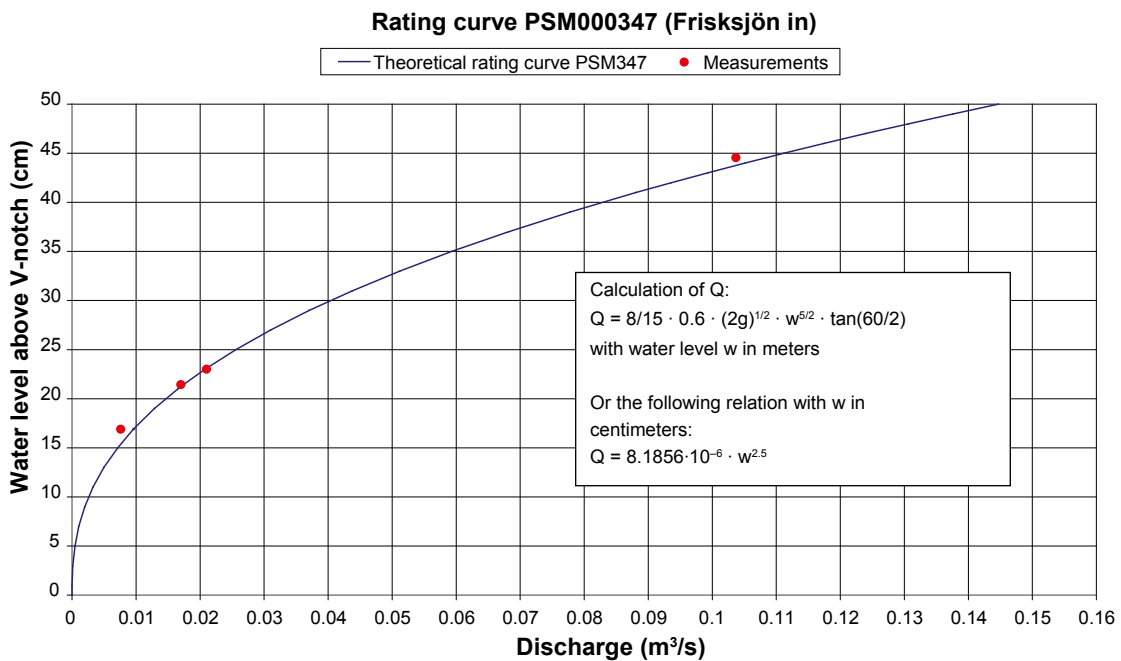

*Figure A2-4. Made control measurements in relation to the theoretically calculated discharge at PSM000347.*

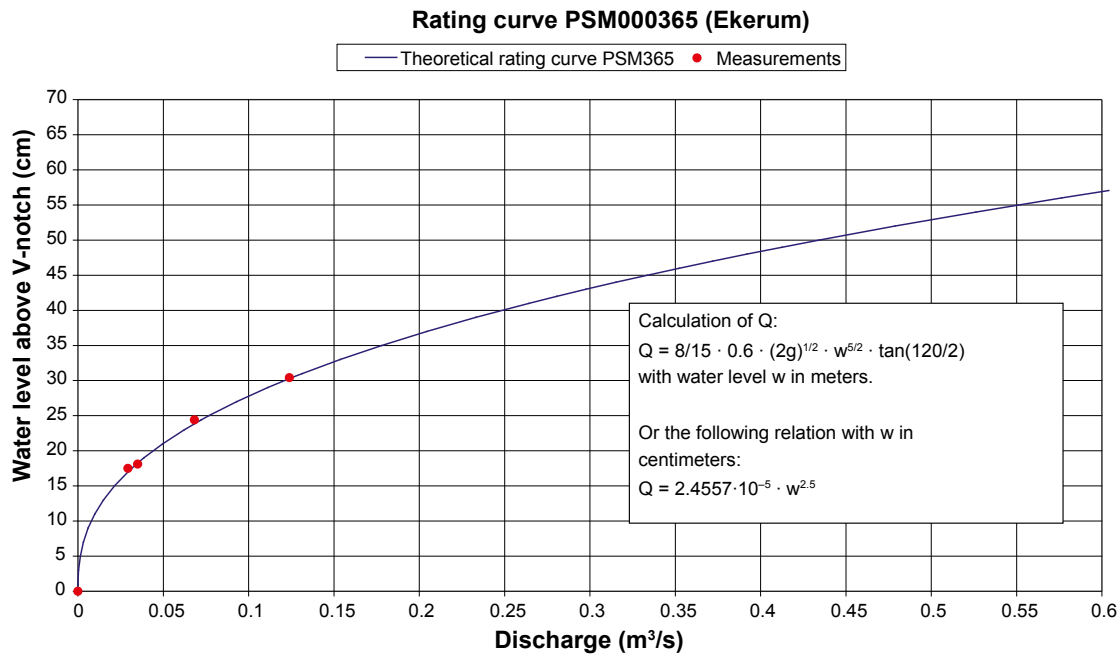

Figure A2-5. Made control measurements in relation to the theoretically calculated discharge at PSM000365.

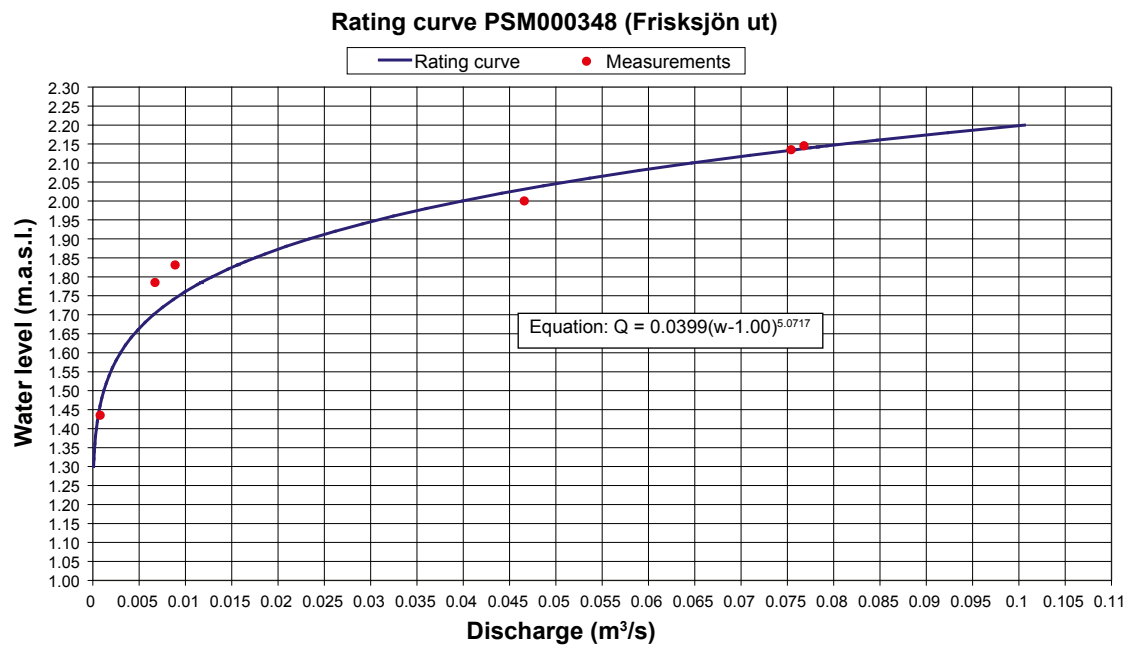

Figure A2-6. Rating curve for PSM000348 Frisksjön out based on made control measurements.

### PSM000353

The discharge in Laxemarån upper is determined by using the natural sections (Equation 1) and the contraction made by the road culvert just downstream the station (Equation 2). The discharge is for the present calculated with two rating equations. The first is valid up to the water level +10.23 metres above sea level and the other for higher levels. The following rating curves have been established based on control measurements made up to now.

### PSM000364

The discharge in Laxemarån lower is determined by using the threshold and contraction made by the earlier concrete construction. The discharge is for the present calculated by the following rating curve.

### PSM000368

The discharge in Kärrviksån is determined by using downstream sections and contractions in the watercourse. The discharge is for the present calculated by two rating curves, since control measurements have shown that different sections is determining the discharge in different rating registers. The first is valid up to water level +1.94 metres above sea level and the other for higher water levels. The following rating curve has been established based on control measurements made up to now.

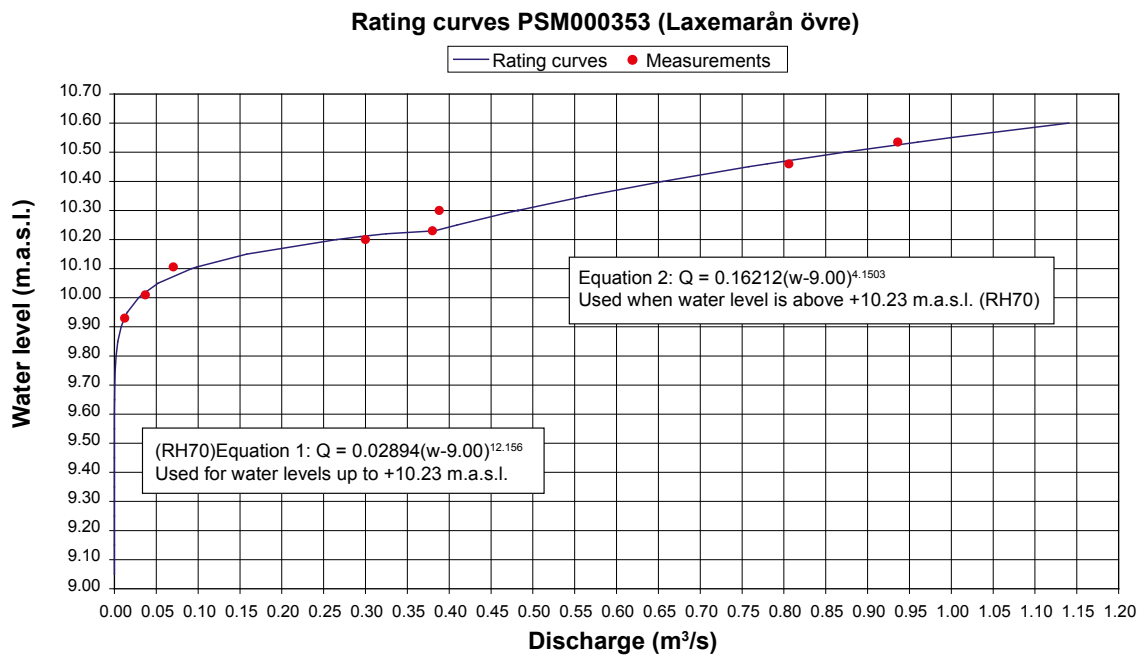

**Figure A2-7.** Rating curve for PSM000353 Laxemarån upper based on control measurements made up to now.

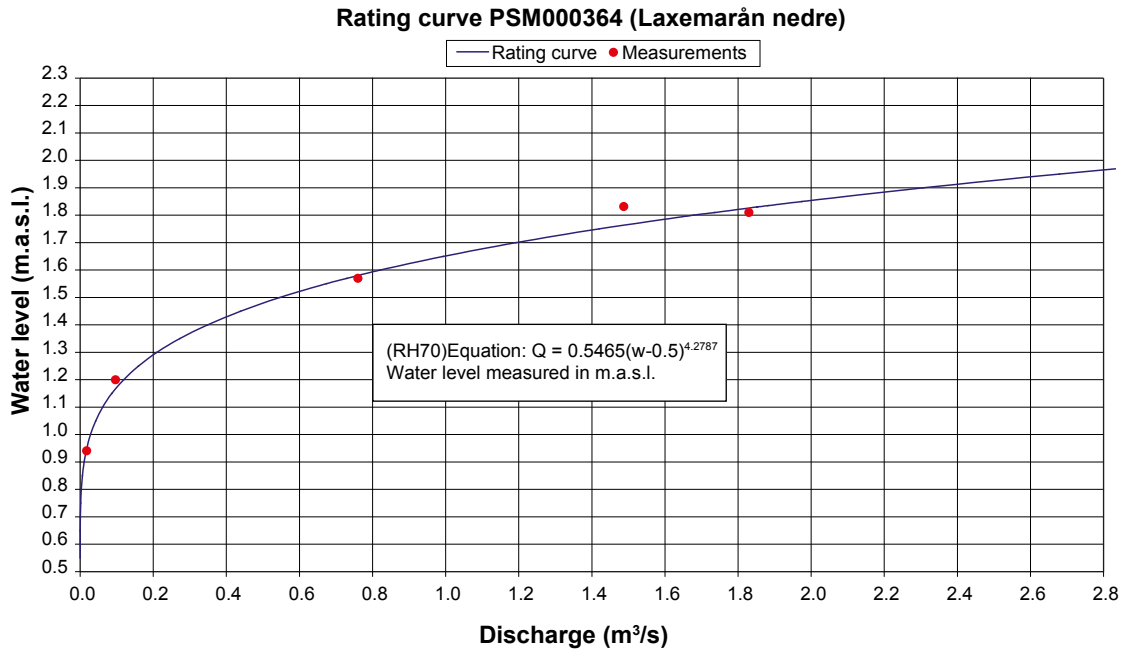

*Figure A2-8. Rating curve for PSM000364 Laxemarån lower based on control measurements made up to now.*

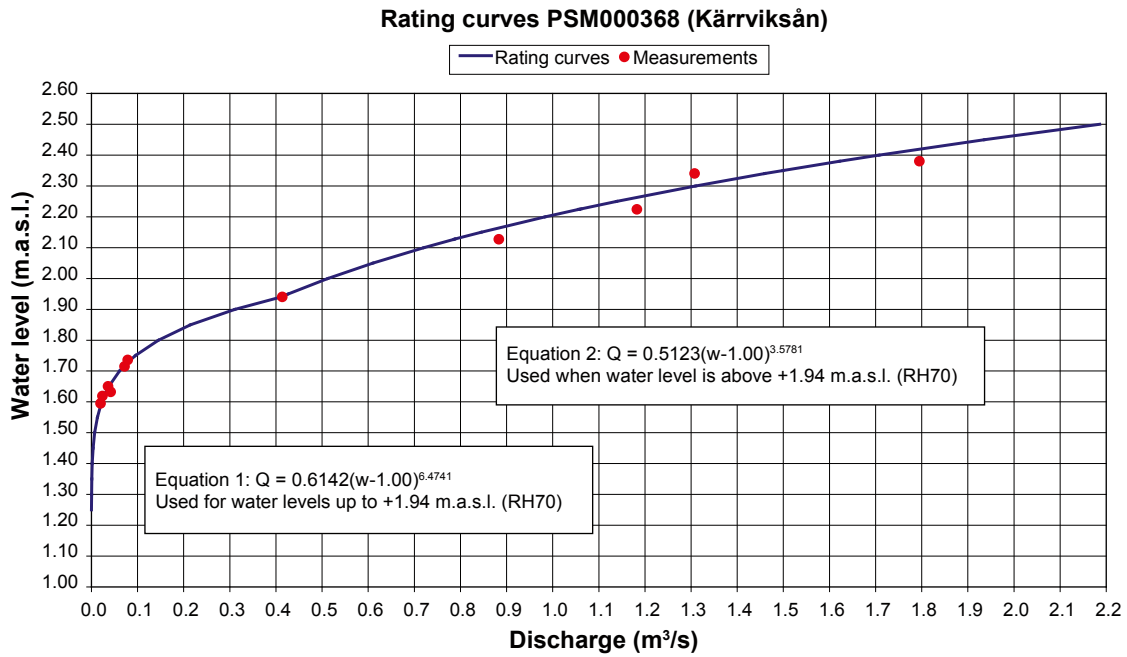

*Figure A2-9. Rating curve for PSM000368 Kärriksån based on control measurements made up to now.*

## Measurements of snow cover

### Primary data from snow depth measurements during the winter 2005/2006

The data collected during the snow depth measurements are presented below as individual measurements as well as the calculated average snow depth and a visual estimate of the coverage degree. S=completely or almost covered ground, SB = more than half of the ground snow covered but not completely covered, BS = more than half of the ground free of snow but not completely, B = the ground completely or almost completely free of snow.

**Table A3-1. Snow depth at “Grillplatsen” (ASM100224) during the winter 2005/2006.**

Start date	Stop date	Point 1 (cm)	Point 2 (cm)	Point 3 (cm)	Point 4 (cm)	Point 5 (cm)	Point 6 (cm)	Average snow cover (cm)	Snow cover- age
2005-11-14	2005-11-14								B
2005-11-28	2005-11-28								BS
2005-12-01	2005-12-01	3	3	4	3	2	3	3	S
2005-12-16	2005-12-16	7	7	10	9	9	9		B
2005-12-20	2005-12-20							8.5	S
2006-01-02	2006-01-02	27	27	27	27	29	25	27	S
2006-01-12	2006-01-12	13	13	12	12	14	15	13.2	S
2006-01-20	2006-01-20	11	13	10	13	17	13	12.8	S
2006-01-26	2006-01-26	13	9	10	12	12	12	11.3	S
2006-02-03	2006-02-03	10	11	12	12	13	13	11.8	S
2006-02-09	2006-02-09	19	16	13	21	19	17	17.5	S
2006-02-23	2006-02-23	15	20	20	20	20	20	19.2	S
2006-03-02	2006-03-02	16	20	19	30	29	34	24.7	S
2006-03-16	2006-03-16	37	25	37	37	43	45	37.3	S
2006-03-24	2006-03-24	35	38	33	33	43	38	36.7	S
2006-03-28	2006-03-28	31	26	23	25	27	35	27.8	S
2006-04-11	2006-04-11								B



## Measurements of ground frost

### Primary data from measurement of frost in the ground during the winter 2005/2006

The data collected during the measurements of ground frost are presented below. As the whole device was not situated within the ground, the levels for ground surface are above the 0-level. The upper registration is the level of the upper border of the ground frost read from the device whereas the lower registration is the lower border. The upper and lower levels of ground frost are calculated using the level of the ground surface and the upper and lower registrations, respectively. From these two levels the distribution of ground frost has been calculated.

**Table A4-1. Frost in ground during the winter 2005/2006 at Grillplatsen (PSM007724).**

Start Date	Stop Date	Ground surface (cm)	Upper reg (cm)	Lower reg (cm)	Upper level of ground frost (cm)	Lower level of ground frost (cm)	Ground frost distribution (cm)
2005-11-14	2005-11-14	100					
2005-11-18	2005-11-18	100	0	110	0	10	10
2005-11-29	2005-11-29	100	0	111	0	11	11
2005-12-16	2005-12-16	100	0	112	0	12	12
2005-12-20	2005-12-20	100	0	113	0	13	13
2006-01-12	2006-01-12	100					
2006-01-20	2006-01-20	100	0	110	0	10	10
2006-02-03	2006-02-03	100	0	103	0	3	3
2006-02-09	2006-02-09	100	81	114	0	14	14
2006-02-17	2006-02-17	100	0	105	0	5	5
2006-02-23	2006-02-23	100	90	103	0	3	3
2006-03-02	2006-03-02	100	0	109	0	9	9
2006-03-17	2006-03-17	100	0	106	0	6	6
2006-03-24	2006-03-24	100	0	110	0	10	10
2006-03-28	2006-03-28	100					
2006-04-11	2006-04-11	100					

**Table A4-2. Frost in ground during the winter 2005/2006 at Äspö (PSM6978).**

Start Date	Stop Date	Ground surface (cm)	Upper reg (cm)	Lower reg (cm)	Upper level of ground frost (cm)	Lower level of ground frost (cm)	Ground frost distribution (cm)
2005-11-18	2005-11-18	95	0	100	0	5	5
2005-11-29	2005-11-29	95	0	95	0	0	0
2005-12-16	2005-12-16	95	0	100	0	5	5
2005-12-20	2005-12-20	95	0	101			
2006-01-04	2006-01-04	95					
2006-01-12	2006-01-12	95					
2006-01-20	2006-01-20	95	0	103	0	8	8
2006-01-26	2006-01-26	95	0	102	0	7	7
2006-02-03	2006-02-03	95	0	99	0	4	4
2006-02-10	2006-02-10	95	76	100	0	5	5

Start Date	Stop Date	Ground surface (cm)	Upper reg (cm)	Lower reg (cm)	Upper level of ground frost (cm)	Lower level of ground frost (cm)	Ground frost distribution (cm)
2006-02-17	2006-02-17	95	0	98	0	3	3
2006-02-23	2006-02-23	95	71	98	0	3	3
2006-03-02	2006-03-02	95	0	103	0	8	8
2006-03-16	2006-03-16	95	0	98	0	3	3
2006-03-24	2006-03-24	95	0	98	0	3	3
2006-03-28	2006-03-28	95	79	95	0	0	0
2006-04-11	2006-04-11	95					

**Table A4-3. Frost in ground during the winter 2005/2006 at Grindstugan (PSM6979).**

Start Date	Stop Date	Ground surface (cm)	Upper reg (cm)	Lower reg (cm)	Upper level of ground frost (cm)	Lower level of ground frost (cm)	Ground frost distribution (cm)
2005-11-14	2005-11-14	100					
2005-11-18	2005-11-18	100	0	102	0	2	2
2005-11-29	2005-11-29	100	0	77	0	0	0
2005-12-16	2005-12-16	100	0	64	0	0	0
2005-12-20	2005-12-20	100					
2005-12-21	2005-12-21	100					
2006-01-02	2006-01-02	100	0	95	0	0	0
2006-01-12	2006-01-12	100	84	91	16	0	0
2006-01-20	2006-01-20	100					
2006-01-26	2006-01-26	100					
2006-02-27	2006-02-27	100					
2006-03-02	2006-03-02	100					
2006-03-17	2006-03-17	100	0	98	0	2	2
2006-03-24	2006-03-24	100					
2006-03-28	2006-03-28	100					
2006-04-11	2006-04-11	100					

**Table A4-4. Frost in ground during the winter 2005/2006 at Åkern (PSM6980).**

Start Date	Stop Date	Ground surface (cm)	Upper reg (cm)	Lower reg (cm)	Upper level of ground frost (cm)	Lower level of ground frost (cm)	Ground frost distribution (cm)
2005-11-14	2005-11-14	92					
2005-11-18	2005-11-18	92	0	100	0	8	8
2005-11-29	2005-11-29	92	0	97	0	5	5
2005-12-16	2005-12-16	92		100		8	8
2005-12-20	2005-12-20	92	0	101	0	9	9
2006-01-02	2006-01-02	92	0	92			
2006-01-09	2006-01-09	92					
2006-01-20	2006-01-20	92	0	100	0	8	8
2006-01-26	2006-01-26	92	0	96	0	4	4
2006-02-03	2006-02-03	92	0	95	0	3	3
2006-02-09	2006-02-09	92	71	97	0	5	5
2006-02-17	2006-02-17	92	0	94	0	2	2
2006-02-23	2006-02-23	92	73	93	0	1	1
2006-03-02	2006-03-02	92	0	99	0	7	7
2006-03-17	2006-03-17	92	0	95	0	3	3
2006-03-24	2006-03-24	92					
2006-03-28	2006-03-28	92					

Meteorological monitoring

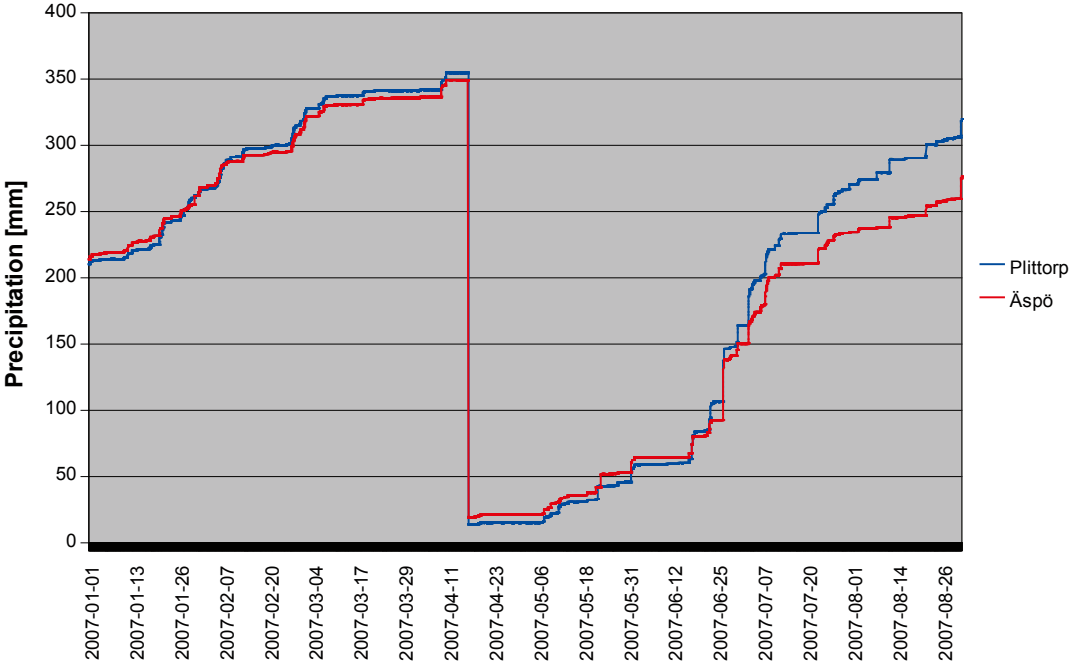

Figure A5-1. Precipitation in mm, 30-min values. January 2007 to August 2007.

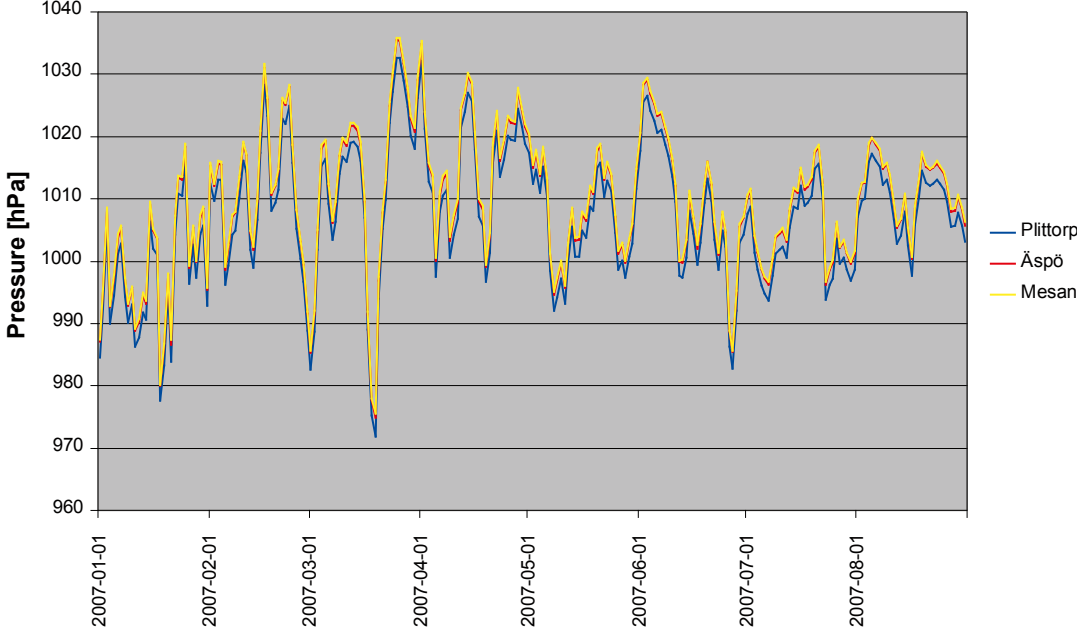

Figure A5-2. Barometric pressure in hPa, daily values. January 2007 to August 2007.

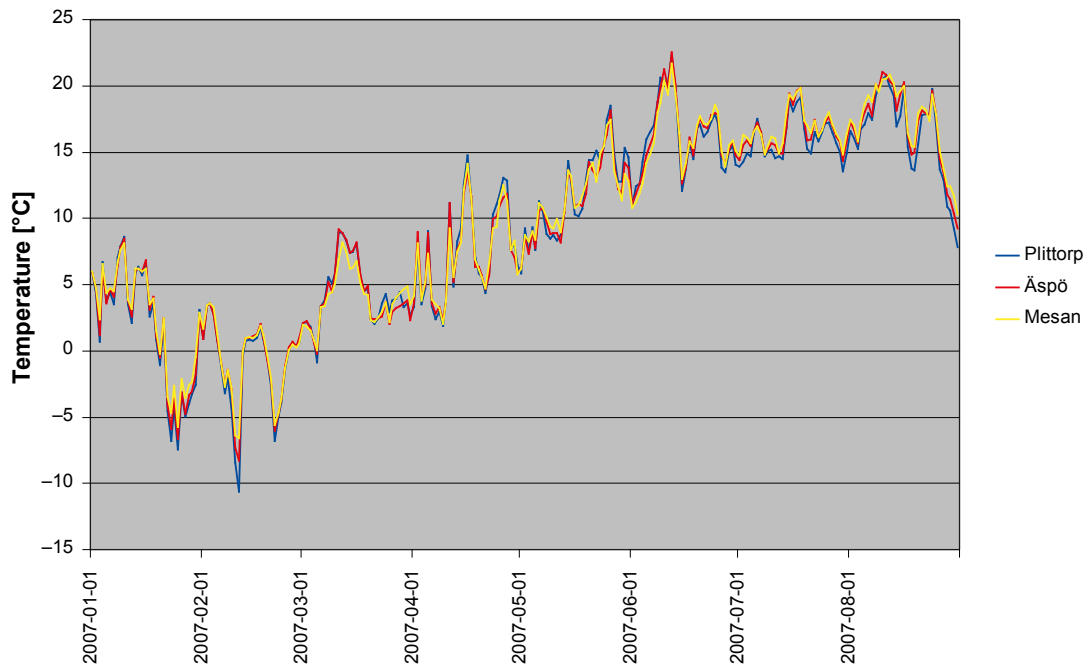

Figure A5-3. Temperature in °C, daily values. January 2007 to August 2007.

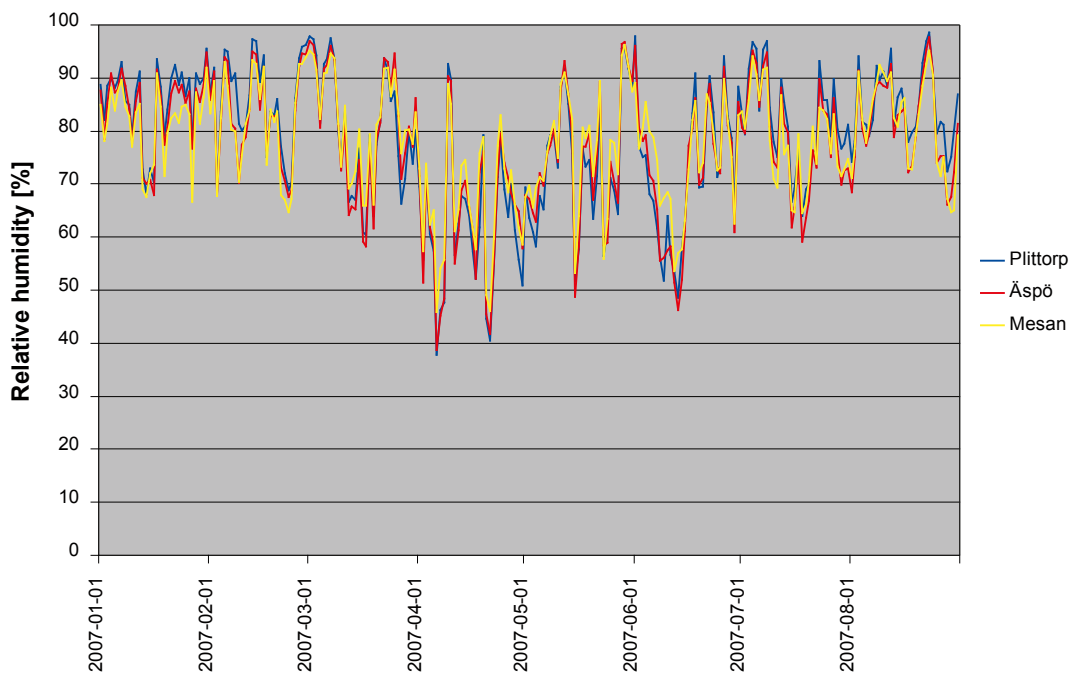

Figure A5-4. Relative humidity in %, daily values. January 2007 to August 2007.

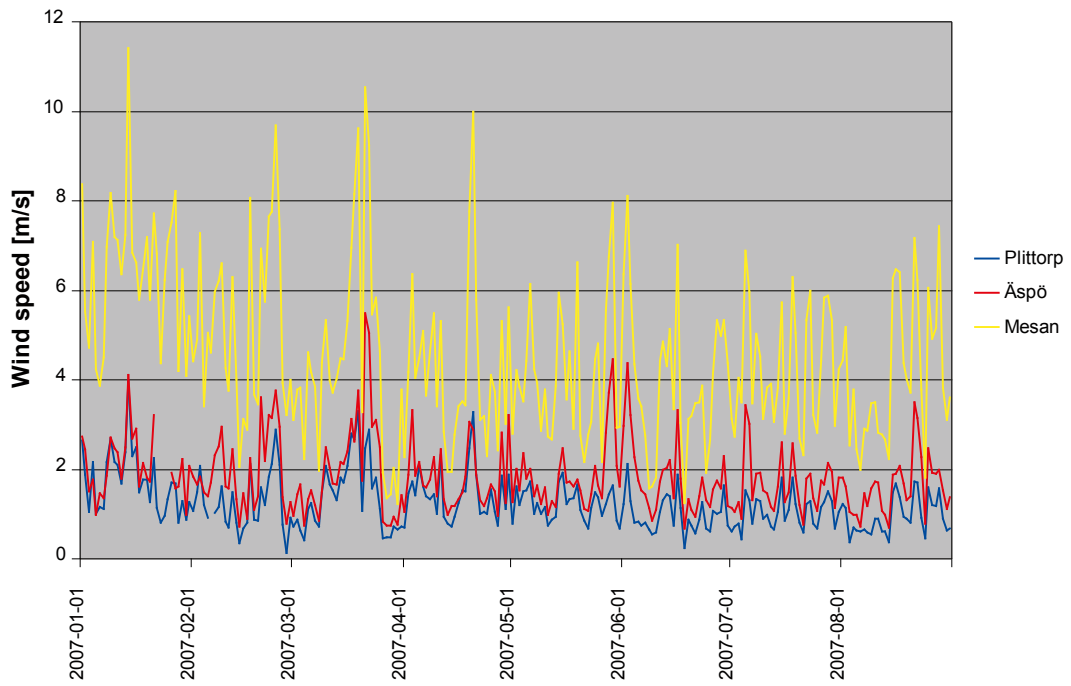

Figure A5-5. Wind speed in m/s, daily values. January 2007 to August 2007.

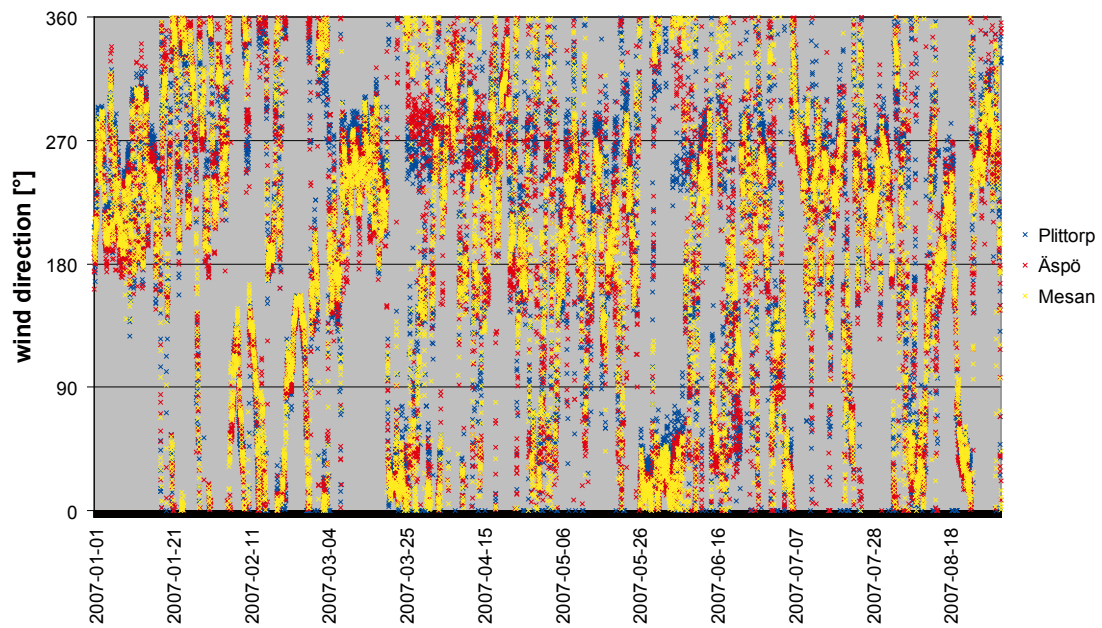

Figure A5-6. Wind direction in  $^{\circ}$ , 30-min values. January 2007 to August 2007.

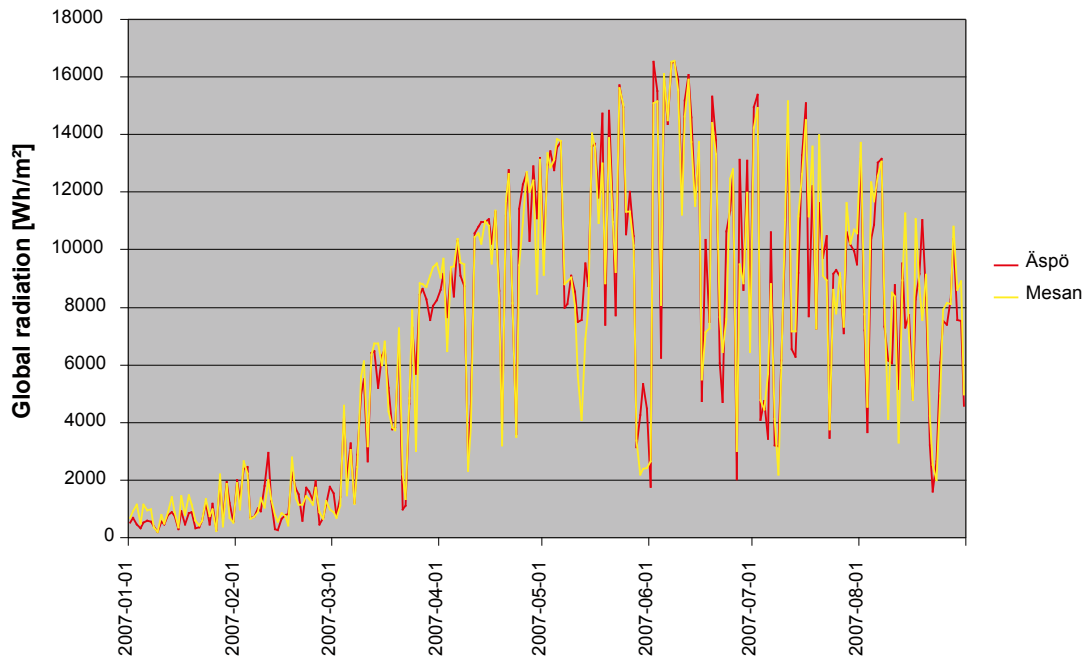

Figure A5-7. Global radiation in Wh/m<sup>2</sup>, daily sum. January 2007 to August 2007.

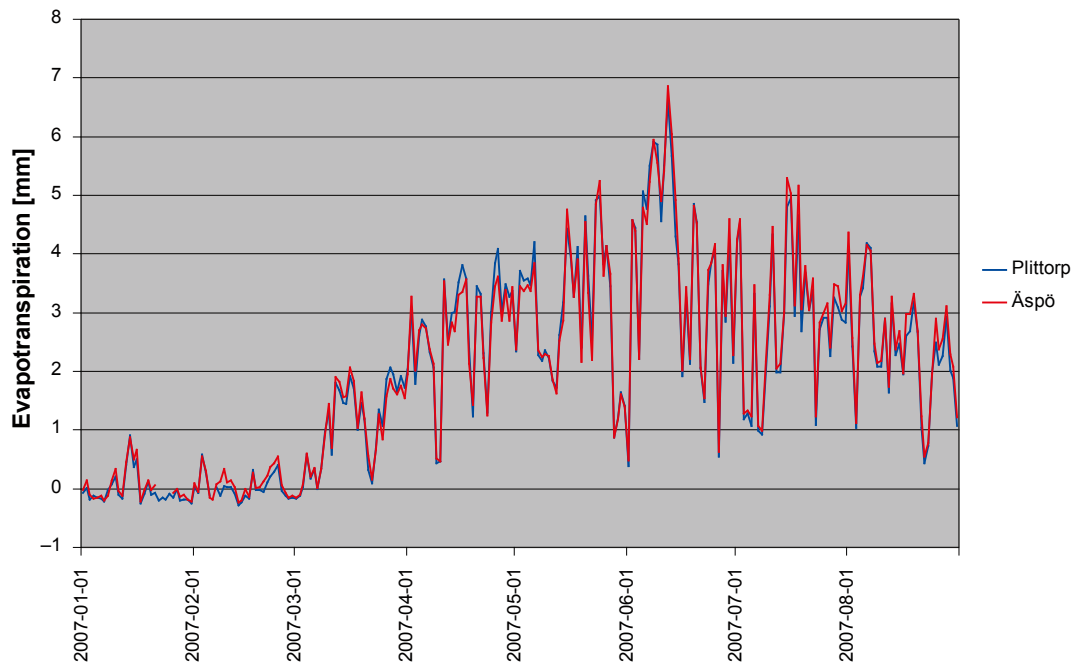
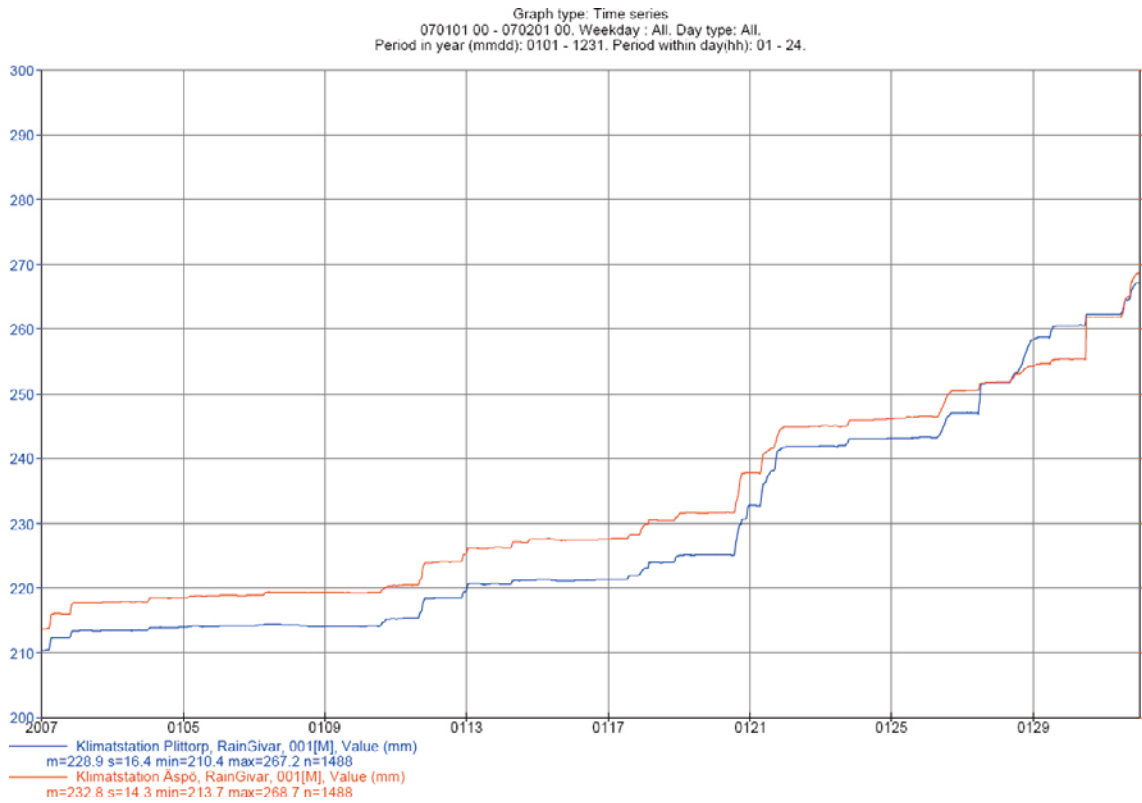
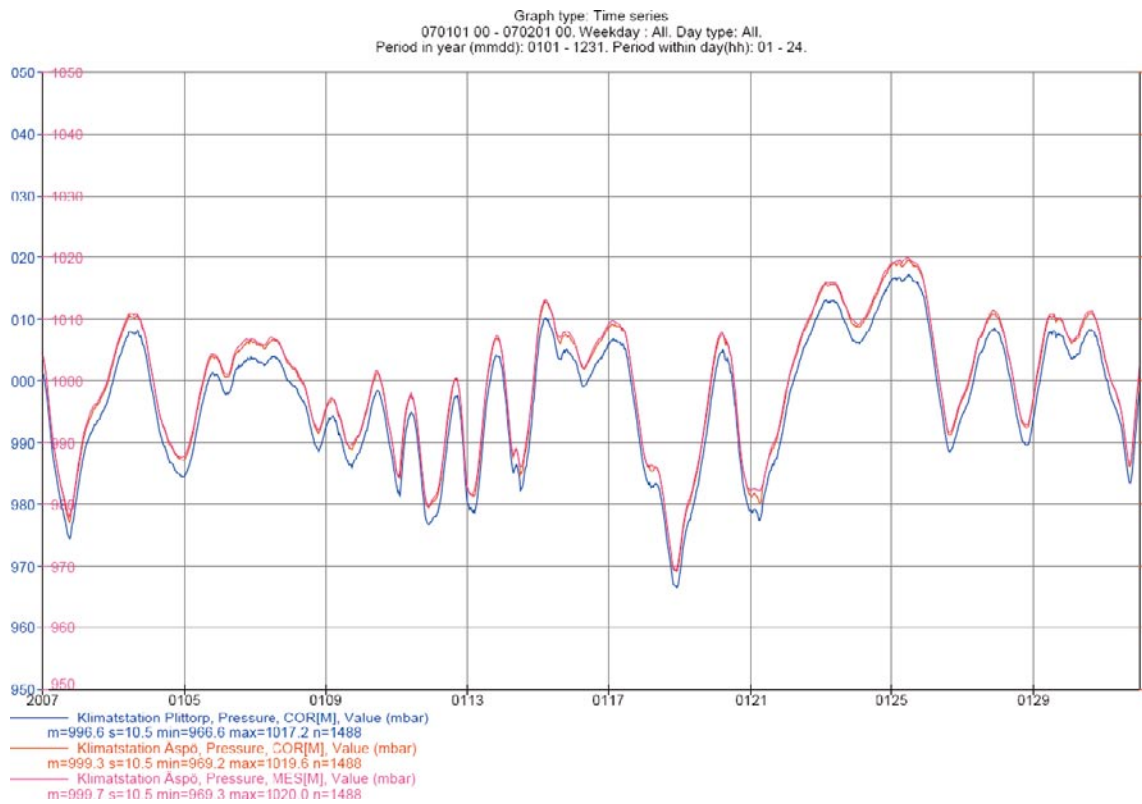

Figure A5-8. Potential evapotranspiration in mm, daily sum. January 2007 to August 2007.



**Figure A5-9.** Precipitation in mm, 30-min values. January 2007.



**Figure A5-10.** Barometric pressure in Pa, 30-min-values. January 2007.



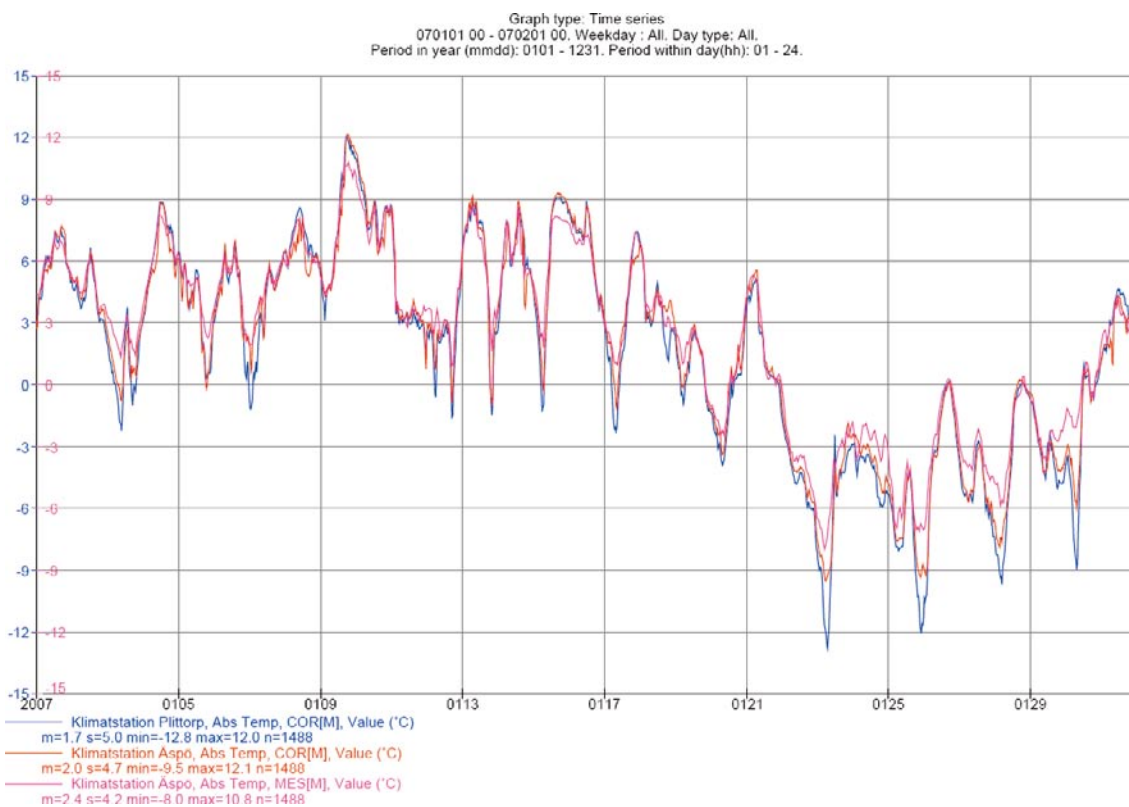

Figure A5-11. Temperature in °C, 30-min-values. January 2007.

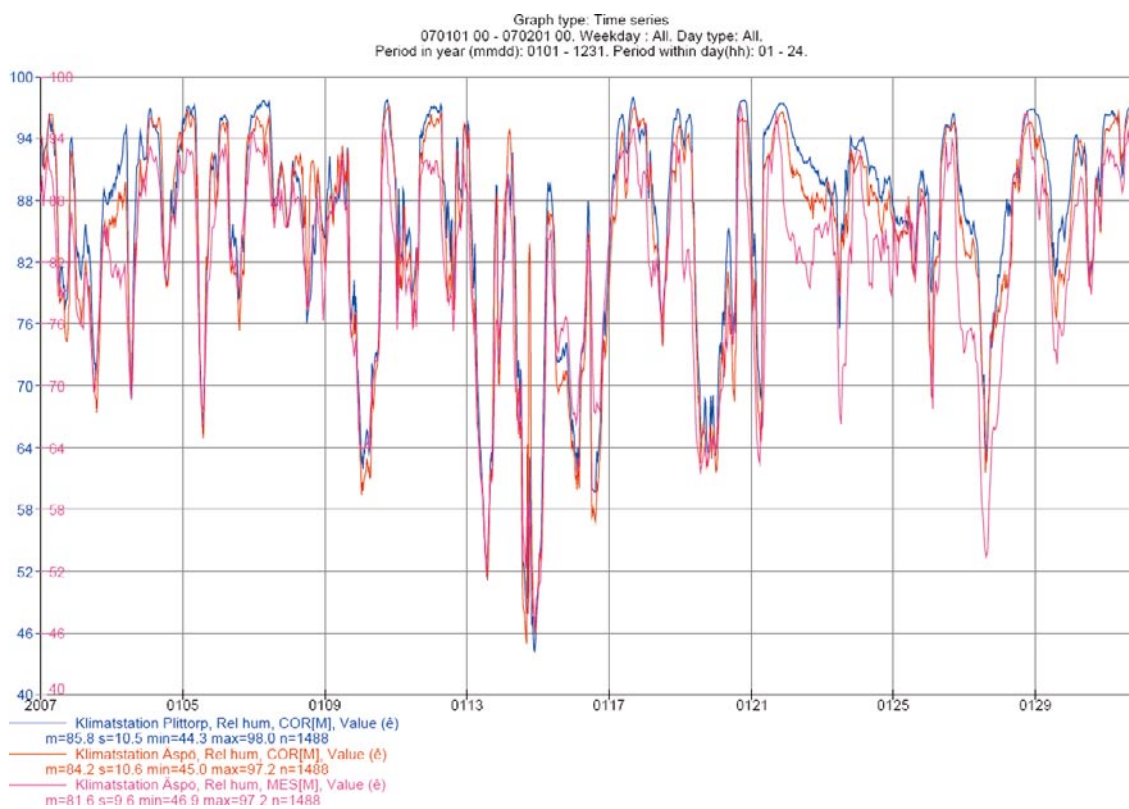

Figure A5-12. Relative humidity in %, 30-min values. January 2007.

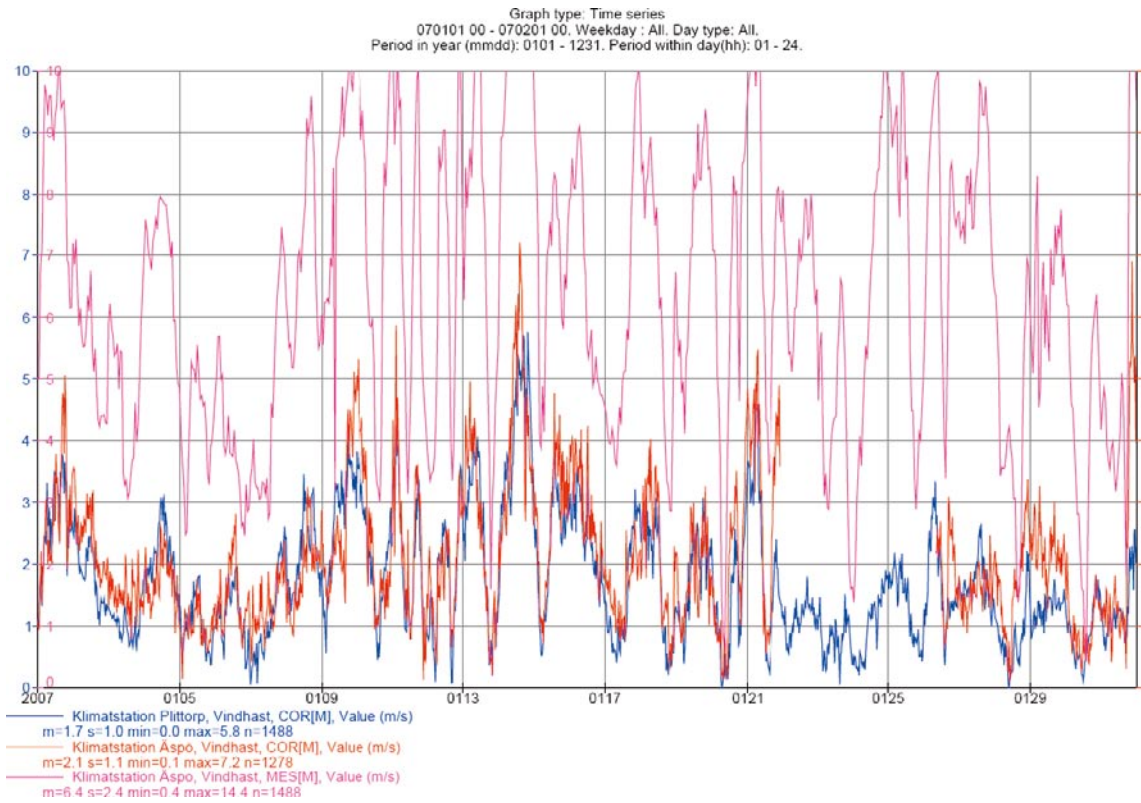

Figure A5-13. Wind speed in m/s, 30-min values. January 2007.

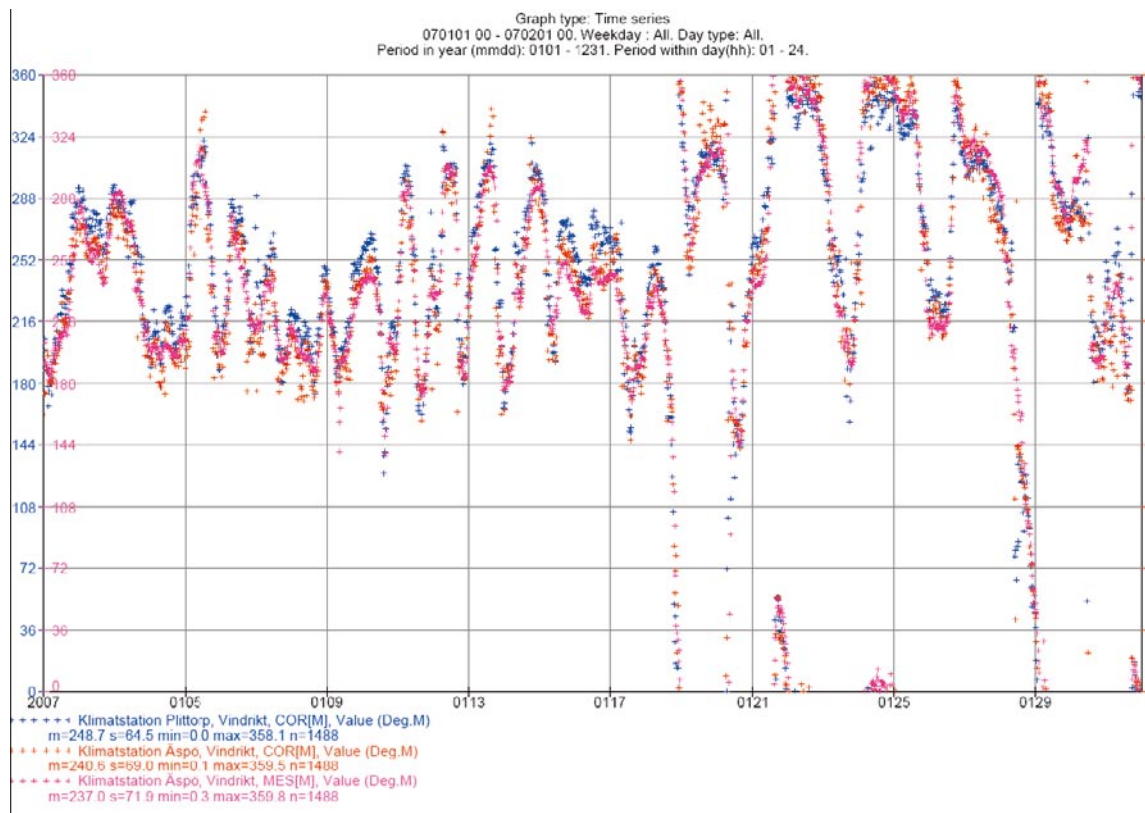

Figure A5-14. Wind direction in °, 30-min values. January 2007.

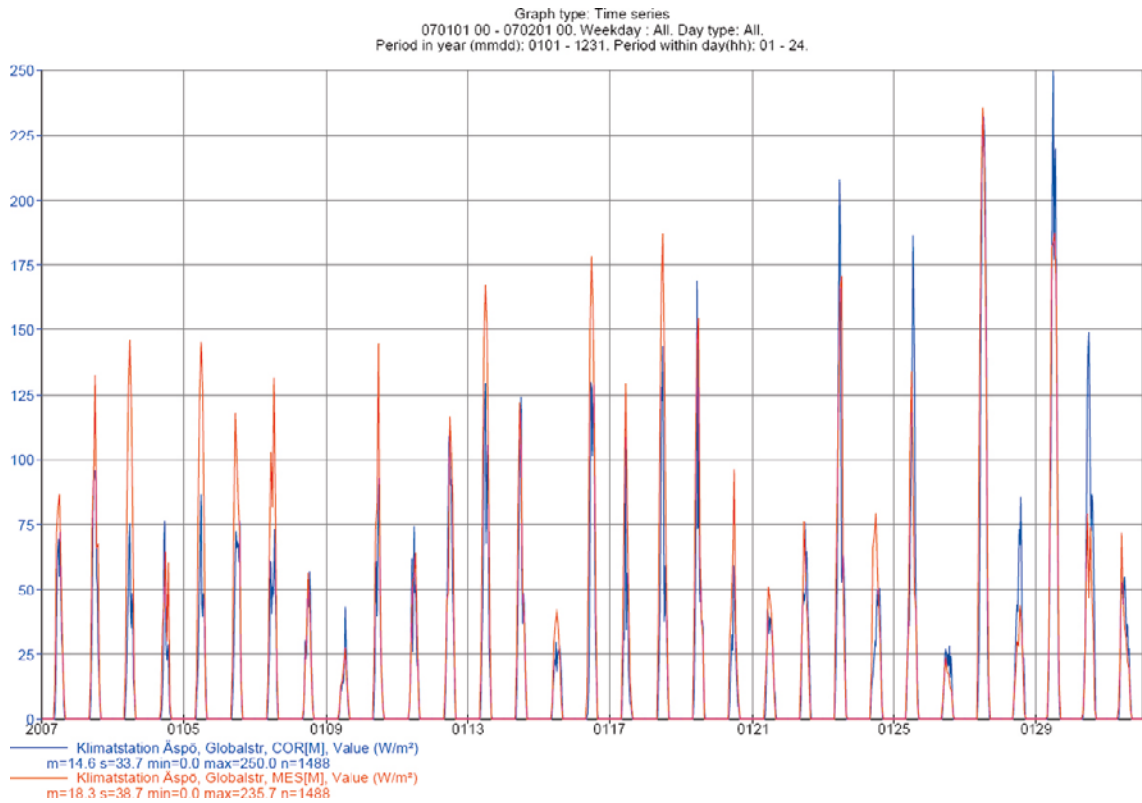

Figure A5-15. Global radiation in  $W/m^2$ , 30-min values. January 2007.

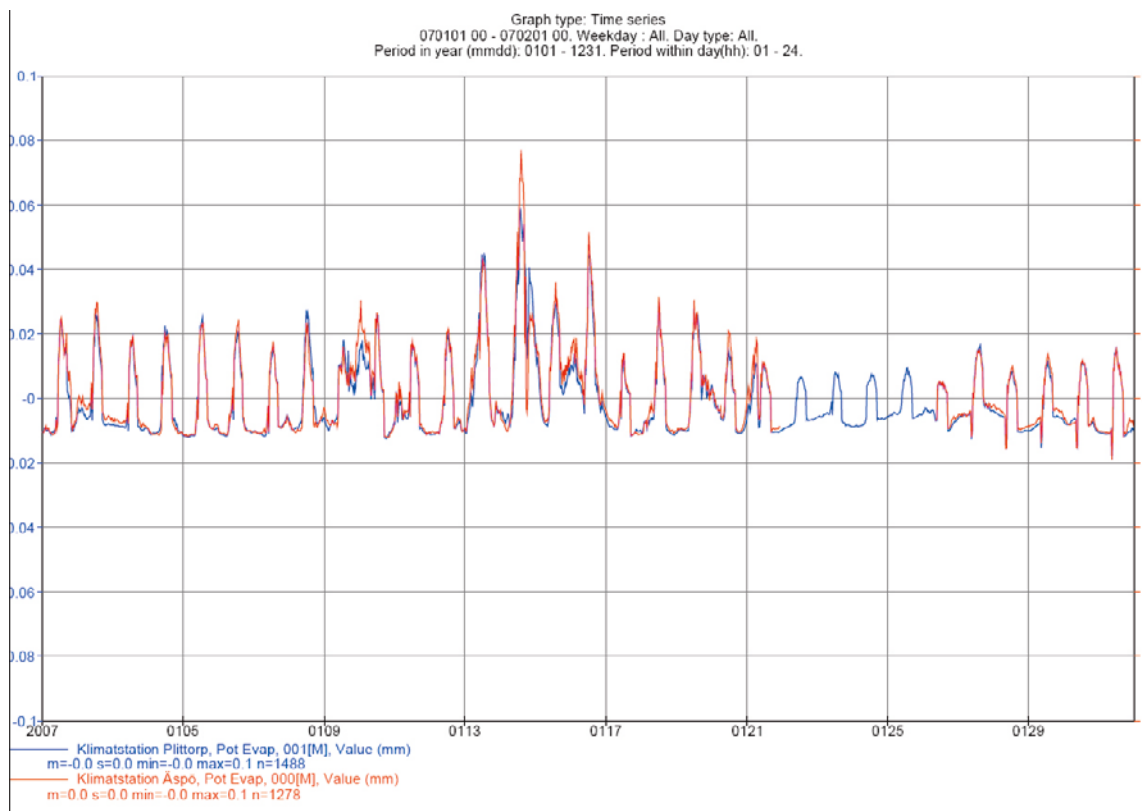

Figure A5-16. Evapotranspiration in mm, 30-min values. January 2007.